

Simplified template cross sections for Higgs boson decays in $H \rightarrow ZZ^* \rightarrow 4l$ channel

Han Li (李涵)

山东大学

中国物理学会高能物理分会第十四届全国粒子物理学术会议

2024年8月13日至18日, 青岛

Outline

1. Brief introduction for decay side simplified template cross section (STXS)
2. SM and BSM samples production
3. Event reconstruction and selection
4. Some results of new simple fiducial selection
5. Summary

Motivation

- The goal of doing Higgs decay measurements is to provide inputs that can be used for theory interpretation.
- Current STXS measurements are inclusive in the Higgs decay, focus on production mode, But on the decay side we just take branch ratios, so we do actually measure the inclusive fixed decays.

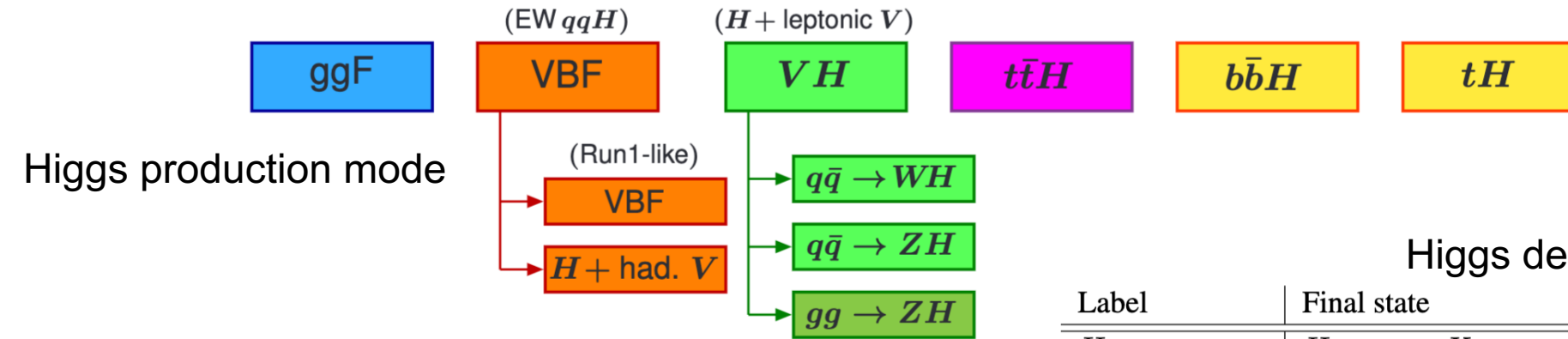

- To define STXS classification for Higgs decay side.

- Decay mode
=> For each final state define a phase space region that approximates the experimental acceptance.
- Measure properties within each decay mode.
=> Allow decay properties to be used to constraint BSM effects in this decay.

Higgs decay modes.

Label	Final state	Kinematic selection
$H \rightarrow ee$	$H \rightarrow ee + X$	$m_{ee} \geq 120 \text{ GeV}$
$H \rightarrow ff$	$H \rightarrow f\bar{f} + X$	$m_{ff} \geq 105 \text{ GeV}$
$H \rightarrow Z\gamma$	$H \rightarrow ee + \gamma + X$	$50 \leq m_{ff} < 120 \text{ GeV}, m_{ff\gamma} \geq 120 \text{ GeV}$
$H \rightarrow Z\gamma$	$H \rightarrow ff + \gamma + X$	$50 \leq m_{ff} < 105 \text{ GeV}, m_{ff\gamma} \geq 120 \text{ GeV}$
$H \rightarrow \gamma^*\gamma$	$H \rightarrow ff + \gamma + X$	$m_{ff} < 50 \text{ GeV}, m_{ff\gamma} > 120 \text{ GeV}$
$H \rightarrow \gamma\gamma$	$H \rightarrow \gamma\gamma$	$m_{\gamma\gamma} = 125 \text{ GeV}$
$H \rightarrow 4\ell$	$H \rightarrow 4\ell + X$	$m_{34} \geq 10 \text{ GeV}, m_{34} \leq m_{12} < 105 \text{ GeV}$
$H \rightarrow 2e2\mu$	$H \rightarrow 2e2\mu + X$	$m_{34} \geq 10 \text{ GeV}, m_{34} \leq m_{12} < 105 \text{ GeV}$
$H \rightarrow 2\ell 2\nu$	$H \rightarrow \ell\nu\nu + X$	$80 \leq m_{2\ell} < 105 \text{ GeV}$
$H \rightarrow 2\ell 2f$	$H \rightarrow \ell\ell ff + X$	$80 \leq m_{2\ell} < 105 \text{ GeV}, ff \neq ee, \mu\mu, \nu\nu$
$H \rightarrow \ell\nu\ell\nu$	$H \rightarrow \ell\nu\ell\nu + X$	$10 < m_{\ell\ell} < 80 \text{ GeV}$
$H \rightarrow e\nu\mu\nu$	$H \rightarrow e\nu\mu\nu + X$	$10 < m_{e\mu} < 105 \text{ GeV}$
$H \rightarrow \ell\nu ff'$	$H \rightarrow \ell\nu ff' + X$	$10 < m_{\ell\nu} < ? \text{ GeV}$
$H \rightarrow fff'f'$	$H \rightarrow fff'f' + X$	$10 < m_{12} < 105 \text{ GeV}, fff'f' \neq \text{modes above}$
$H \rightarrow f_1f_2f_3f_4$	$H \rightarrow f_1f_2f_3f_4 + X$	$f_1f_2f_3f_4 \neq \text{modes above}$

EFT model dependency

- The acceptance of the $H \rightarrow 4l$ measurements have dependence on EFT parameters

$$\mathcal{L}_{EFT} = \mathcal{L}_{SM} + \sum_i \frac{C_i^{(5)}}{\Lambda} \mathcal{O}_i^{(5)} + \sum_i \frac{C_i^{(6)}}{\Lambda^2} \mathcal{O}_i^{(6)} + \sum_i \frac{C_i^{(7)}}{\Lambda^3} \mathcal{O}_i^{(7)} + \sum_i \frac{C_i^{(8)}}{\Lambda^4} \mathcal{O}_i^{(8)} + \dots$$

where each term $\mathcal{O}_i^{(D)}$ is invariant operator, parameters $C_i^{(D)}$ are called the Wilson coefficients.

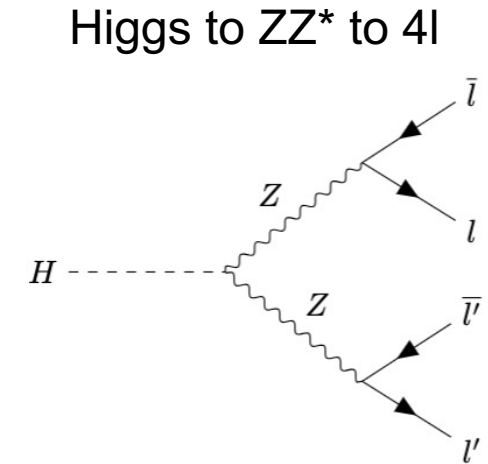
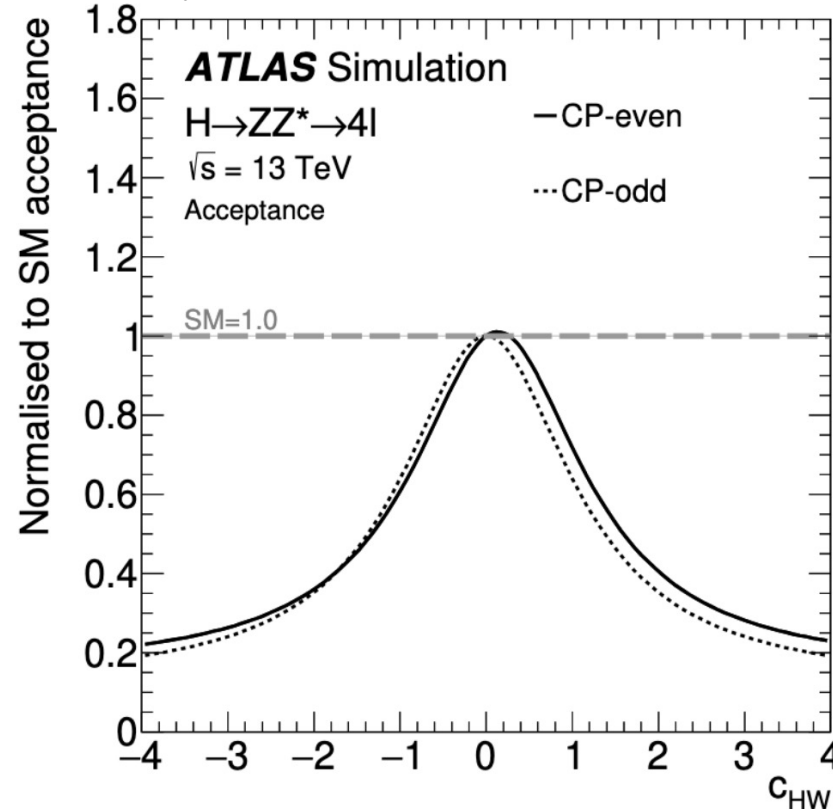
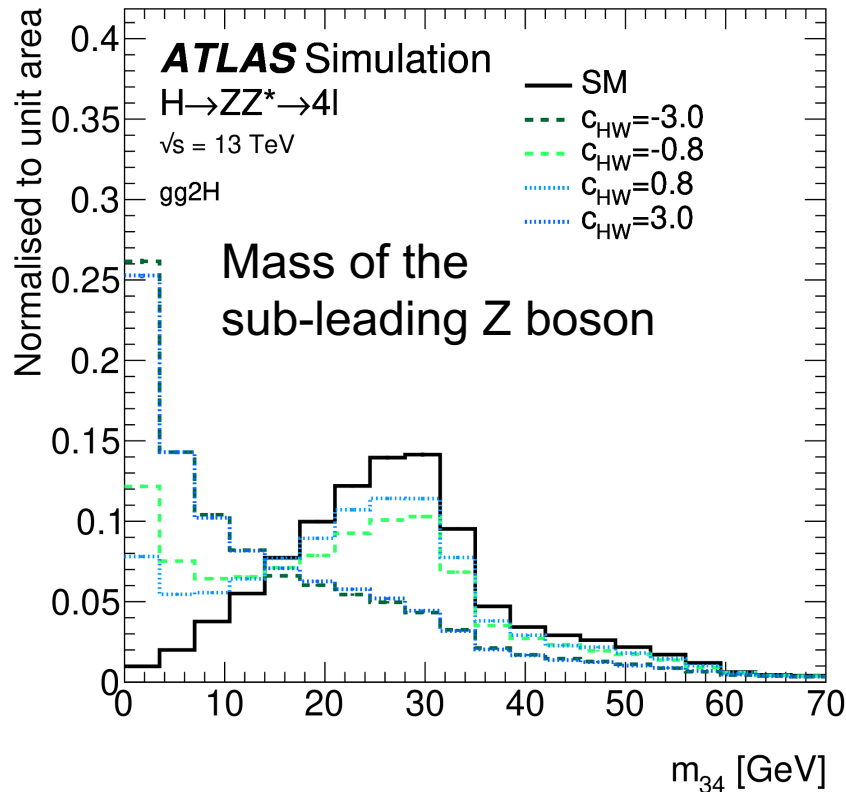

- Experiments apply selection in $H \rightarrow 4l$ that has a high acceptance for the SM, but the acceptance can be low for some BSM models.
- The idea would be decay volumes to match closer experiments.

Lorentz invariance fiducial selection

Idea:
To design a new fiducial selection for Higgs decay in 4l

Requirement:
The Higgs decay property measurement should be valid independent of the Higgs production mode or boost of the Higgs.

It should be valid for LHC
7, 8, 13, 13.6 and 14 TeV.

It should be valid for pp and
e+e- colliders.

Higgs is Spin 0, so production and decay completely decouple. All of the above is possible, if the STXS decay selection is Lorentz invariant.

Goal:
A new Lorentz invariant fiducial selection,
called simple fiducial selection:

Be "larger" than
experimental selection

Cover almost all
reconstruction events

Same fiducial acceptance for
SM and BSM models

Make the STXS decay valid
for BSM interpretations

Same behavior for critical
variables as function of EFT

Measure decay properties
for BSM

Samples production

- The effect of new physics contributions are tested within the SMEFT framework using the EFT operator eigenvectors.
- Used the Madgraph5 to simulate the Higgs production and decay process.

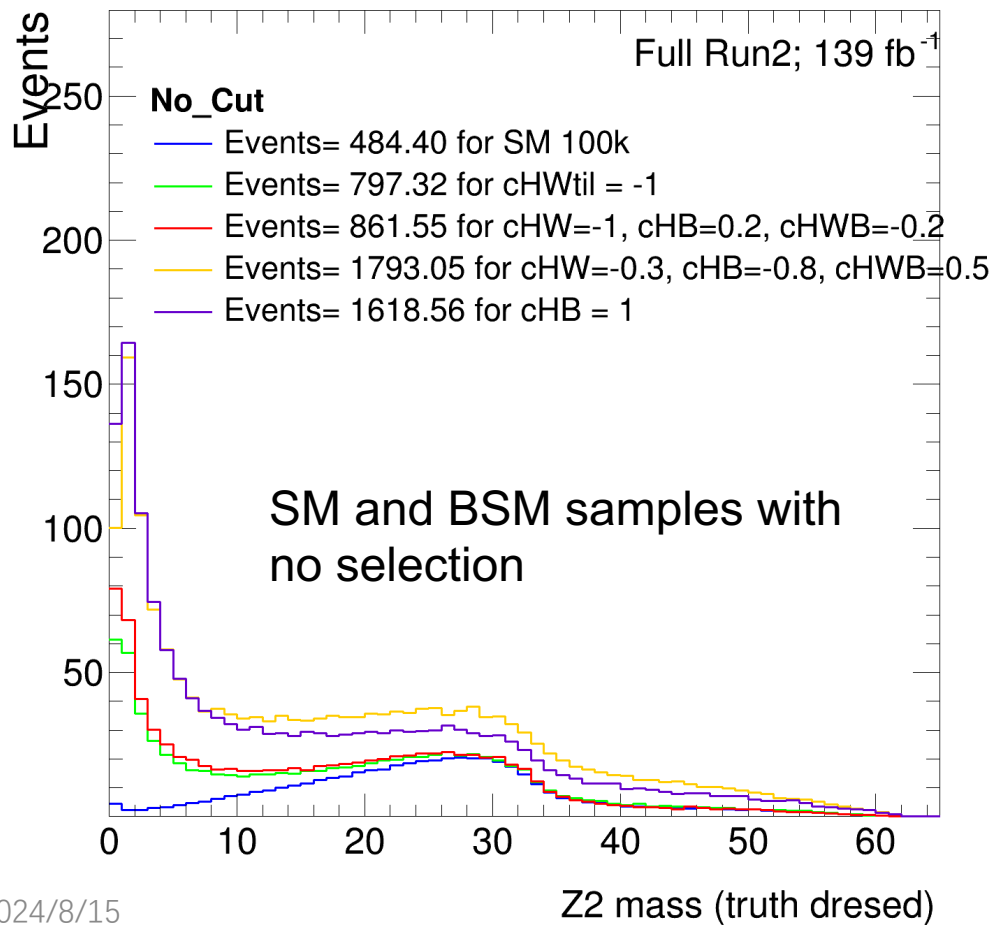

SM and BSM samples	XS * BR (fb)
SM (ggF NNLO official)	6.02392
SM (ggF NLO)	3.485244981
cHWtil = 1	5.736290559
cHWtil = -1	5.736287545
cHWBtil = 1	6.04208718
cHWBtil = -1	6.039951544
cHBtil = 1	22.51140749
cHBtil = -1	22.5140945
cHB = 1	11.64518908
cHB = -1	12.39385404
cHW = 1	6.624299669
cHW = -1	9.002618310
cHWB = 1	6.567085332
cHWB = -1	5.392417526
cHW=-1 cHB=0.2 cHWB=-0.2	6.198411759
cHW=1 cHB=-0.2 cHWB=0.2	5.276027766
cHW=-0.3 cHB=-0.8 cHWB=0.5	12.90020656
cHW=0.3 cHB=0.8 cHWB=-0.5	11.32794347
cHW=-0.1 cHB=0.5 cHWB=0.9	6.473491205
cHW=0.1 cHB=-0.5 cHWB=-0.9	5.651427638

Reconstruction selection and Fiducial selection

- The same reconstruction and selection as ATLAS Run2 HZZ:

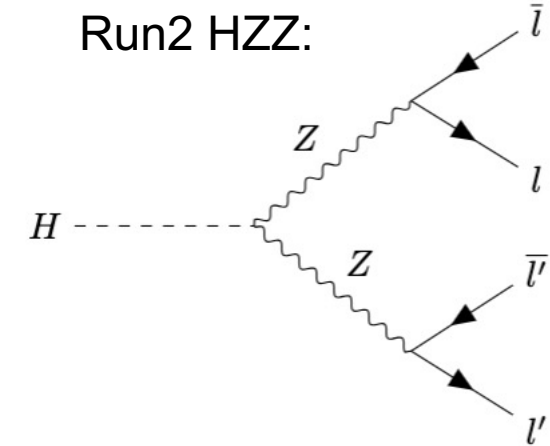

- **Physics Objects:**

Electrons: $E_T > 7\text{GeV}$, $|\eta| < 2.47$
 Muon: $p_T > 5\text{GeV}$, $|\eta| < 2.7$
 Jet: $p_T > 30\text{GeV}$, $|\eta| < 4.5$

- **Reconstruction of 4-lepton candidates:**

Two pairs of same-flavour, opposite charge leptons
 p_T thresholds for three leading leptons: $p_{T1} > 20\text{GeV}$, $p_{T2} > 15\text{GeV}$, $p_{T3} > 10\text{GeV}$

Leading di-lepton mass requirement: $50\text{GeV} < m_{12} < 106\text{GeV}$

Sub-leading di-lepton mass requirement: $m_{\text{threshold}} < m_{34} < 115\text{GeV}$

$\Delta R(l, l') > 0.1$ for all lepton pair

remove the events if di-lepton $m_{ll} < 5\text{GeV}$ to veto the J/ψ (3.1 GeV)

- **Mass window:**

Four-lepton invariant mass window in the signal region:

$$115\text{GeV} < m_{4l} < 130\text{GeV}$$

- Decay side simple fiducial selection:

- Used Lorentz invariants
- Do not remove the reconstructed events
- Same fiducial acceptance and stable for SM and BSM samples

Simple fiducial selection	
<i>Momentum of lepton in Higgs rest frame $P > 4\text{GeV}$</i>	
$50\text{GeV} < m_{12} < 106\text{GeV}$ ($m_{12} = m_{Z1}$)	
$12\text{GeV} < m_{34} < 115\text{GeV}$ ($m_{34} = m_{Z2}$)	
<i>Angle of lepton pair in Higgs rest frame > 0.1 (rad.)</i>	
<i>Low mass dilepton veto: mass of SFOC pair $> 5\text{GeV}$</i>	
<i>Mass window cut: $115\text{GeV} < m_{4l} < 130\text{GeV}$</i>	

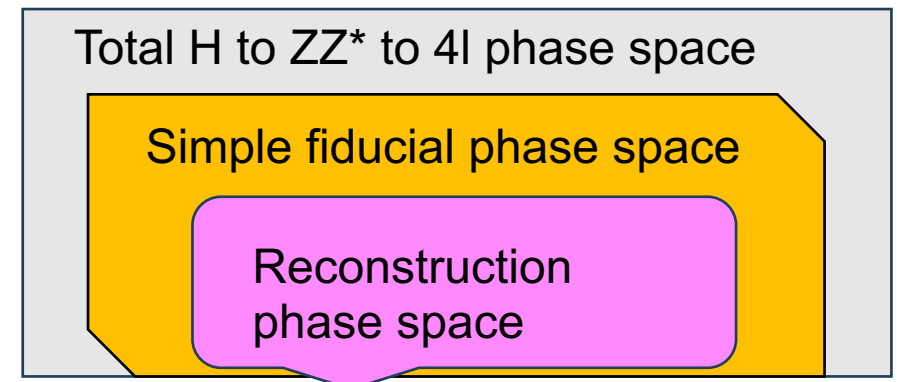

Higgs kinematic-related variables

- Higgs boson kinematic-related variables which are sensitive to the production and decay of the Higgs.

	Higgs boson kinematic-related variables
$m_{12} m_{34}$	Invariant mass of the leading and sub-leading lepton pair
$\cos\theta^*$	Production angle of Z1, defined in the reconstructed four leptons rest frame
$\cos\theta_1$	Production angle of the anti-lepton from the Z1 decay
$\cos\theta_2$	Production angle of the anti-lepton from the Z2 decay
φ	Azimuthal angle between the decay plane of the reconstructed Z1 and the plane of the reconstructed Z2
<i>lepton P</i>	Momentum of lepton in Higgs rest frame
<i>angle (Z1 , l)</i>	Opening Angle between Z1 and decayed lepton pair in Higgs rest frame
<i>angle (Z2 , l)</i>	Opening Angle between Z2 and decayed lepton pair in Higgs rest frame

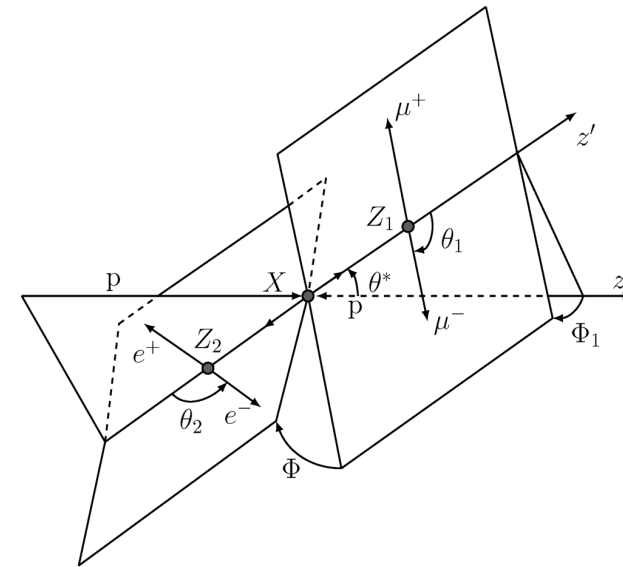

Some results of simple fiducial selection for SM vs. BSM samples

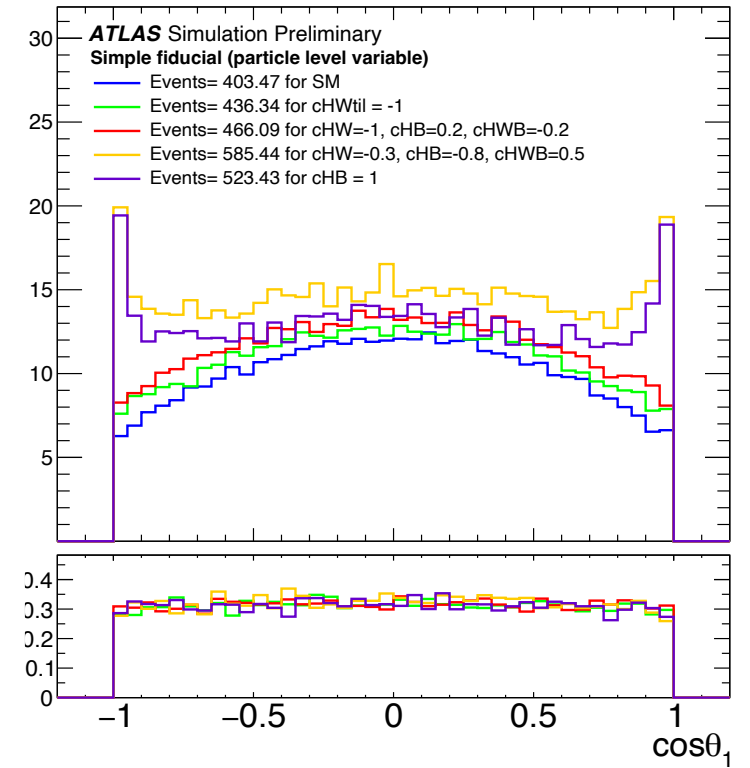
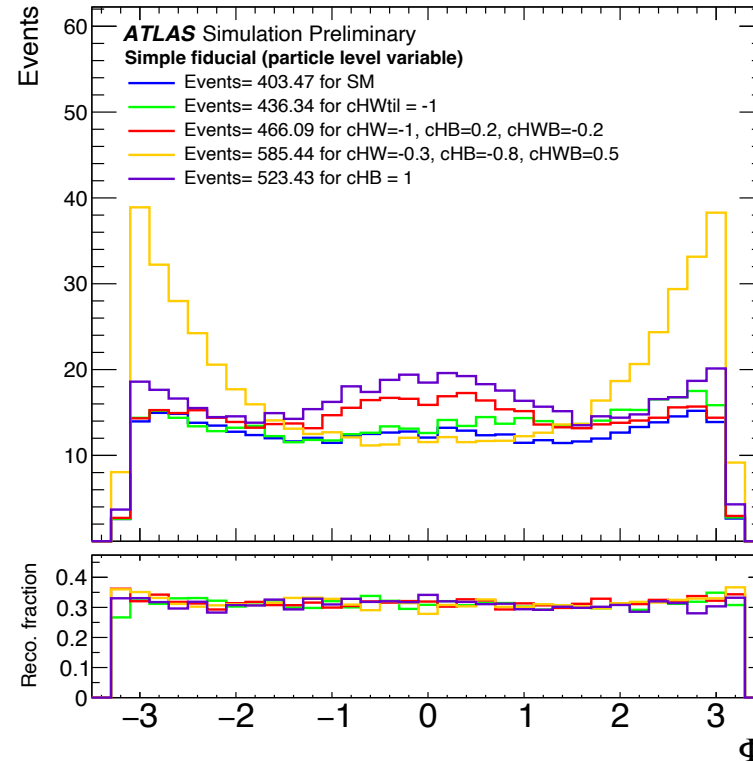
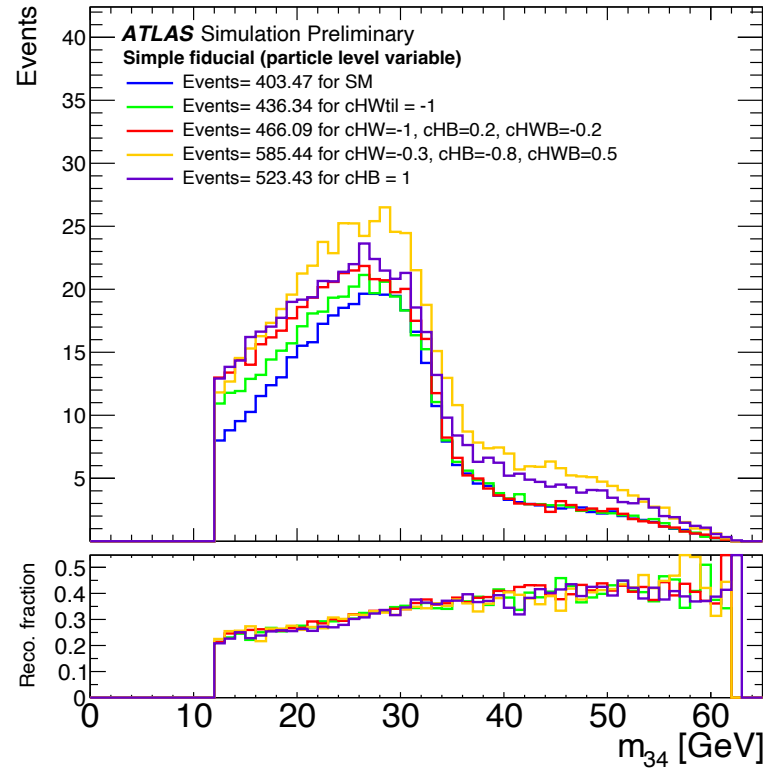

- Top panel: events passed simple fiducial selection.

- Bottom panel:
$$\frac{\text{Reco \& Simple Fiducial}}{\text{Simple Fiducial}}$$

- The ratio histograms show the same shape for different samples, the ratio is stable for SM and all BSM samples.
- The new simple fiducial selection would remove the EFT dependency for acceptance corrections of 4l final state.
- The simple fiducial selection proved loose enough to cover > 99% of reconstructed events.

Summary

- Defined the simple fiducial selection,
 - Covered more than 99% of reconstructed events for all SM and BSM samples
 - Make the ratio $\frac{Reco \& \textit{Fiducial}}{\textit{Fiducial}}$ stable for all SM and BSM samples.
- The ratio is the same for all EFT models, hence a universal unfolding using the SM template is possible for (almost) all BSM samples
- The new simple fiducial selection would remove the EFT dependency for acceptance corrections of 4l final state and can be implemented as reinterpretation of existing measurements
- Next plan: will combine CMS experiments to compare and optimize the performance of simple fiducial selection
- ATLAS PUB Note link: [ATL-PHYS-PUB-2023-033](https://arxiv.org/abs/2308.12345)

Thank you for your attention!

Backup

Selection efficiency

The Simple Fiducial selection should not remove the events that satisfy Reco cut.

So, the ratio (Reco+ Simple Fid)/ Reco should be close to 100%

~33%

>99%

Sample_name	No_Cut	Normal_fiducial	Simple_fiducial	Reco_Cut	Reco_&Normal	Reco_&Simple	Reco&Simple/Fid	Reco&Simple/Reco
ggf_official_SM	842.6293(1.0000)	417.3507(0.4953)	716.3691(0.8502)	200.6465(0.2381)	199.1049(0.2363)	199.6978(0.2370)	0.2788	0.9953
ggf_SM	484.4305(1.0000)	238.2532(0.4918)	403.4666(0.8329)	138.8246(0.2866)	137.8624(0.2846)	138.1487(0.2852)	0.3424	0.9951
ggf_tcHW1	797.3436(1.0000)	256.0637(0.3211)	438.8454(0.5504)	148.6221(0.1864)	147.1702(0.1846)	147.5777(0.1851)	0.3363	0.993
ggf_tcHWm1	797.3503(1.0000)	254.6734(0.3194)	436.3387(0.5472)	144.5543(0.1813)	143.2085(0.1796)	143.5611(0.1800)	0.329	0.9931
ggf_tcHWB1	839.8485(1.0000)	259.5025(0.3090)	442.1410(0.5265)	148.1945(0.1765)	146.9834(0.1750)	147.2662(0.1753)	0.3331	0.9937
ggf_tcHWBm1	839.3133(1.0000)	260.4000(0.3103)	441.7182(0.5263)	151.0356(0.1800)	149.8027(0.1785)	150.0355(0.1788)	0.3397	0.9934
ggf_tcHB1	3129.1064(1.0000)	308.1382(0.0985)	530.6600(0.1696)	174.9073(0.0559)	173.3395(0.0554)	173.1382(0.0553)	0.3263	0.9899
ggf_tcHBm1	3129.4873(1.0000)	304.2913(0.0972)	529.5530(0.1692)	175.7192(0.0561)	173.9414(0.0556)	174.1586(0.0557)	0.3289	0.9911
ggf_cHB1	1618.5846(1.0000)	303.0676(0.1872)	523.4291(0.3234)	172.7202(0.1067)	171.0773(0.1057)	170.9713(0.1056)	0.3266	0.9899
ggf_cHBm1	1722.6237(1.0000)	346.3070(0.2010)	595.2114(0.3455)	199.6287(0.1159)	197.6804(0.1148)	197.6713(0.1148)	0.3321	0.9902
ggf_cHW1	920.7435(1.0000)	261.2406(0.2837)	442.3719(0.4805)	149.3955(0.1623)	148.3314(0.1611)	148.4637(0.1612)	0.3356	0.9938
ggf_cHWm1	1251.3516(1.0000)	278.3190(0.2224)	474.1073(0.3789)	160.9675(0.1286)	159.8036(0.1277)	160.0250(0.1279)	0.3375	0.9941
ggf_cHWB1	912.8521(1.0000)	267.7101(0.2933)	454.0157(0.4974)	153.5774(0.1682)	152.1888(0.1667)	152.5225(0.1671)	0.3359	0.9931
ggf_cHWBm1	749.5040(1.0000)	254.7535(0.3399)	435.5105(0.5811)	147.4985(0.1968)	146.4324(0.1954)	146.7069(0.1957)	0.3369	0.9946
ggf_cHWm1_cHB0p2_cHWBm0p2	861.5692(1.0000)	272.2706(0.3160)	466.0892(0.5410)	155.5095(0.1805)	154.3513(0.1792)	154.4911(0.1793)	0.3315	0.9935
ggf_cHWm0p3_cHBm0p8_cHWB0p5	1793.1547(1.0000)	339.9919(0.1896)	585.4364(0.3265)	197.3488(0.1101)	195.4866(0.1090)	195.4915(0.1090)	0.3339	0.9906
ggf_cHWm0p1_cHB0p5_cHWB0p9	899.8185(1.0000)	259.3308(0.2882)	444.8841(0.4944)	149.4936(0.1661)	148.2034(0.1647)	148.2866(0.1648)	0.3333	0.9919
ggf_cHW0p1_cHBm0p5_cHWBm0p9	785.5001(1.0000)	270.7583(0.3447)	463.3058(0.5898)	154.3108(0.1964)	153.1937(0.1950)	153.3046(0.1952)	0.3309	0.9935
ggf_cHW1_cHBm0p2_cHWB0p2	733.3629(1.0000)	264.5698(0.3608)	454.1311(0.6192)	151.8205(0.2070)	150.4819(0.2052)	150.7722(0.2056)	0.332	0.9931
ggf_cHW0p3_cHB0p8_cHWBm0p5	1574.5645(1.0000)	302.6627(0.1922)	512.8143(0.3257)	173.9715(0.1105)	172.1664(0.1093)	172.1867(0.1094)	0.3358	0.9897

Check for High pT of Higgs(SM)

$0 < p_T < 200 \text{ GeV}$

No selection
Simple Fiducial

Normal Fiducial
Reco selection

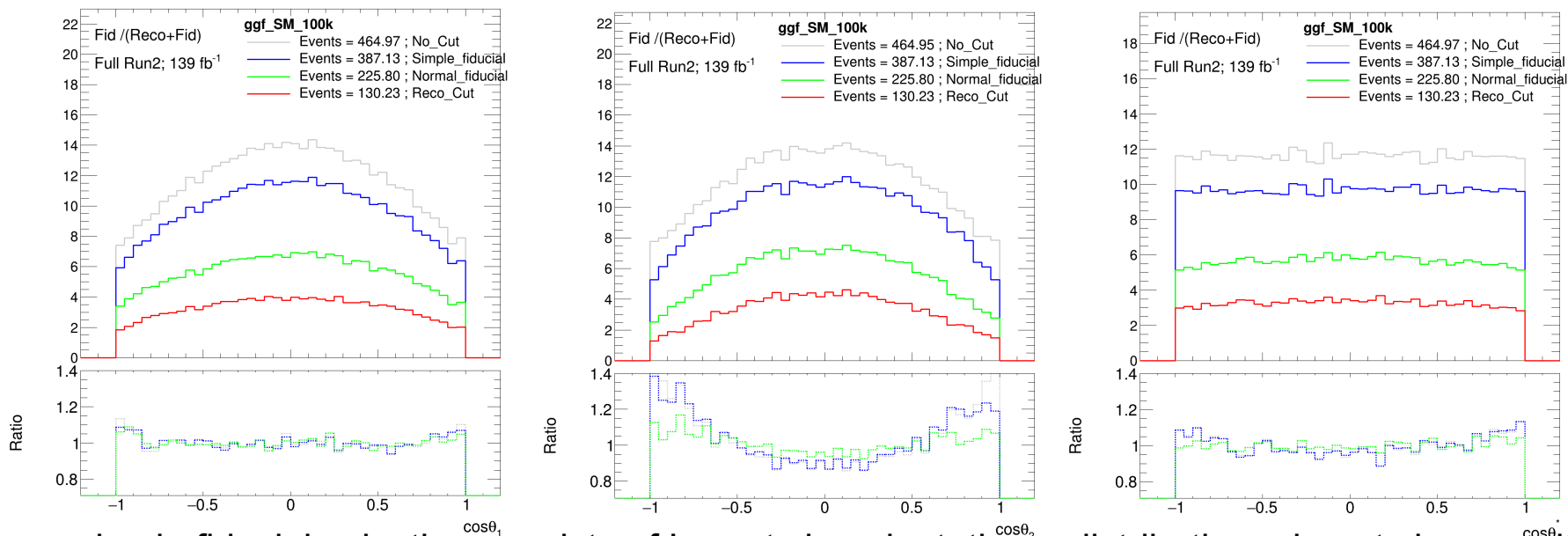

Because simple fiducial selection consists of Lorentz invariant, these distributions do not change with the Higgs pT, and Reco cut is stable for high pT, so the simple fiducial selection also works for high Higgs pT events

$p_T > 200 \text{ GeV}$

No selection
Simple Fiducial

Normal Fiducial
Reco selection

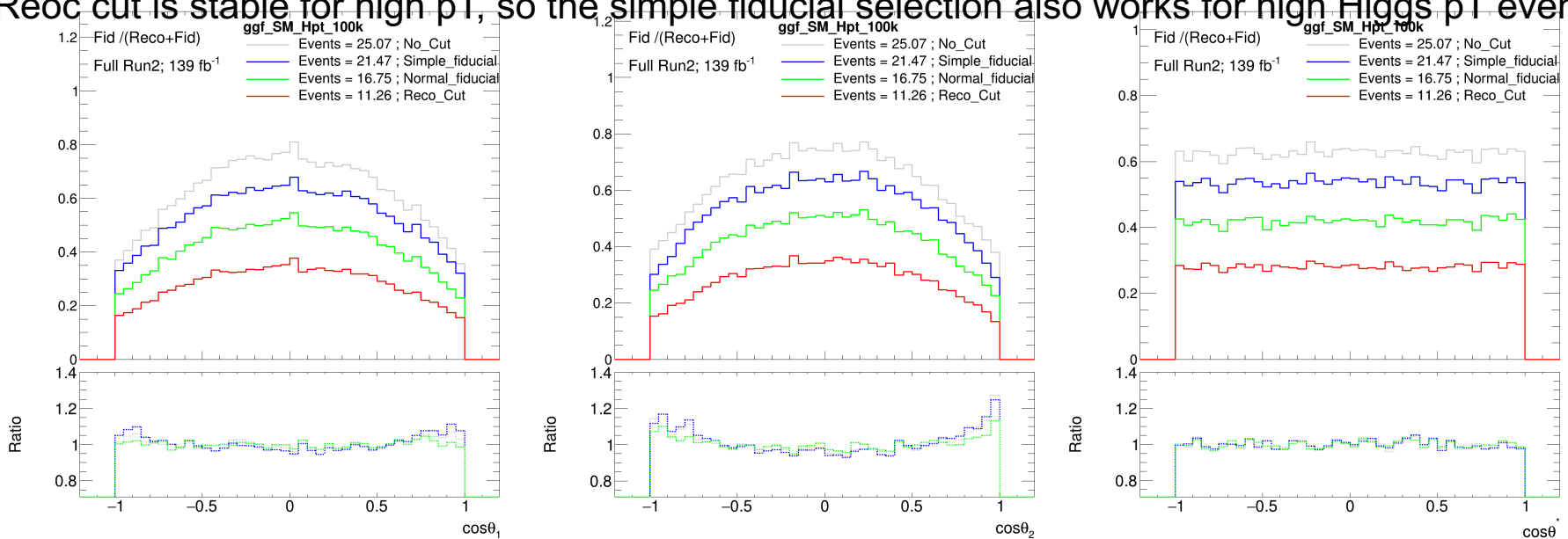

Check for all Higgs productions ($115 < m_{4l} < 130$)

ggF sample

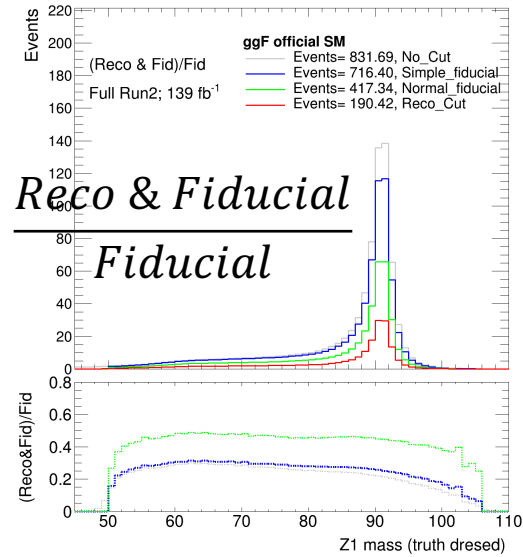
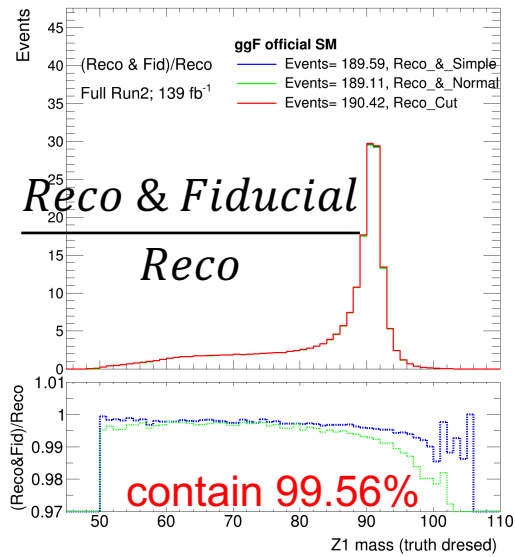

VBF sample

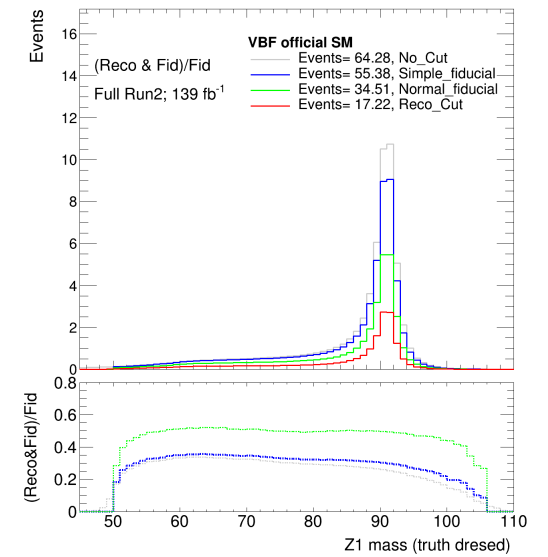
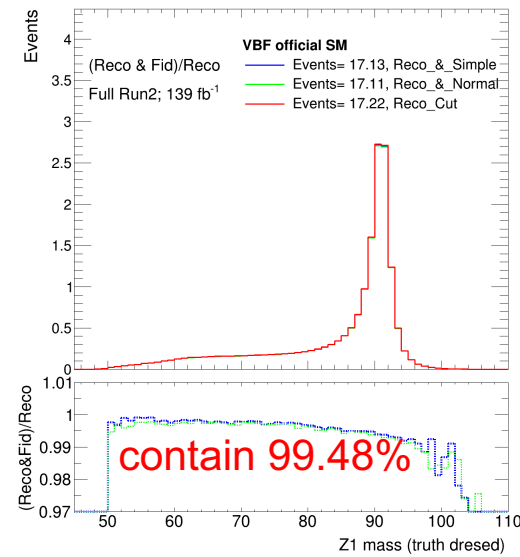

VH (ZH, WH)

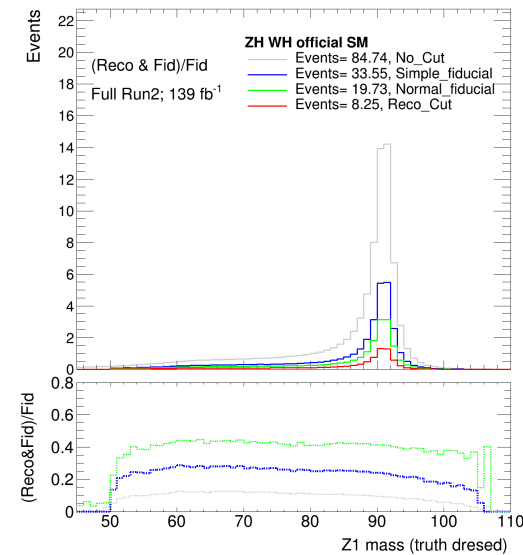
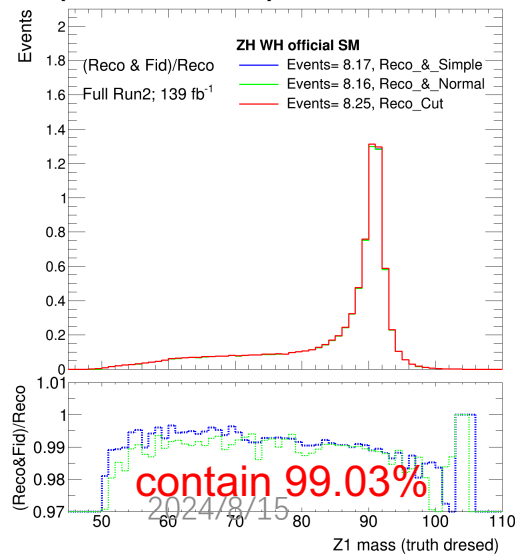

ttH+bbH

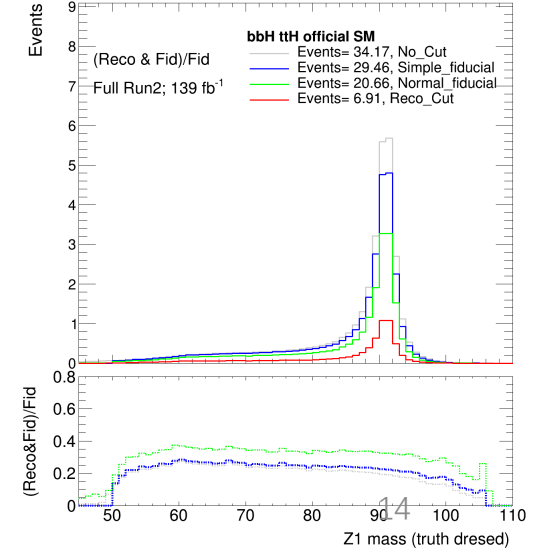
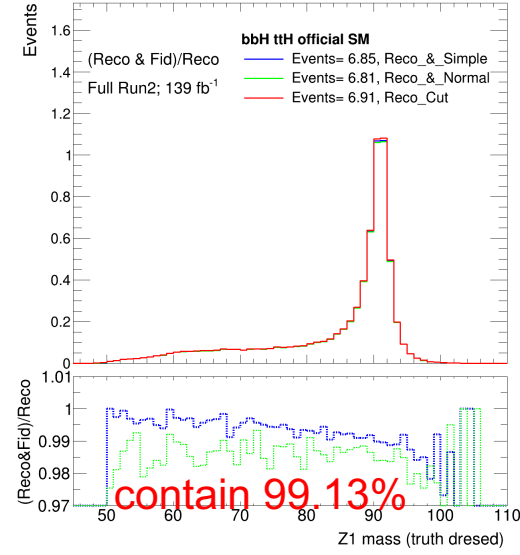

2024/8/15

14

Check for all Higgs productions

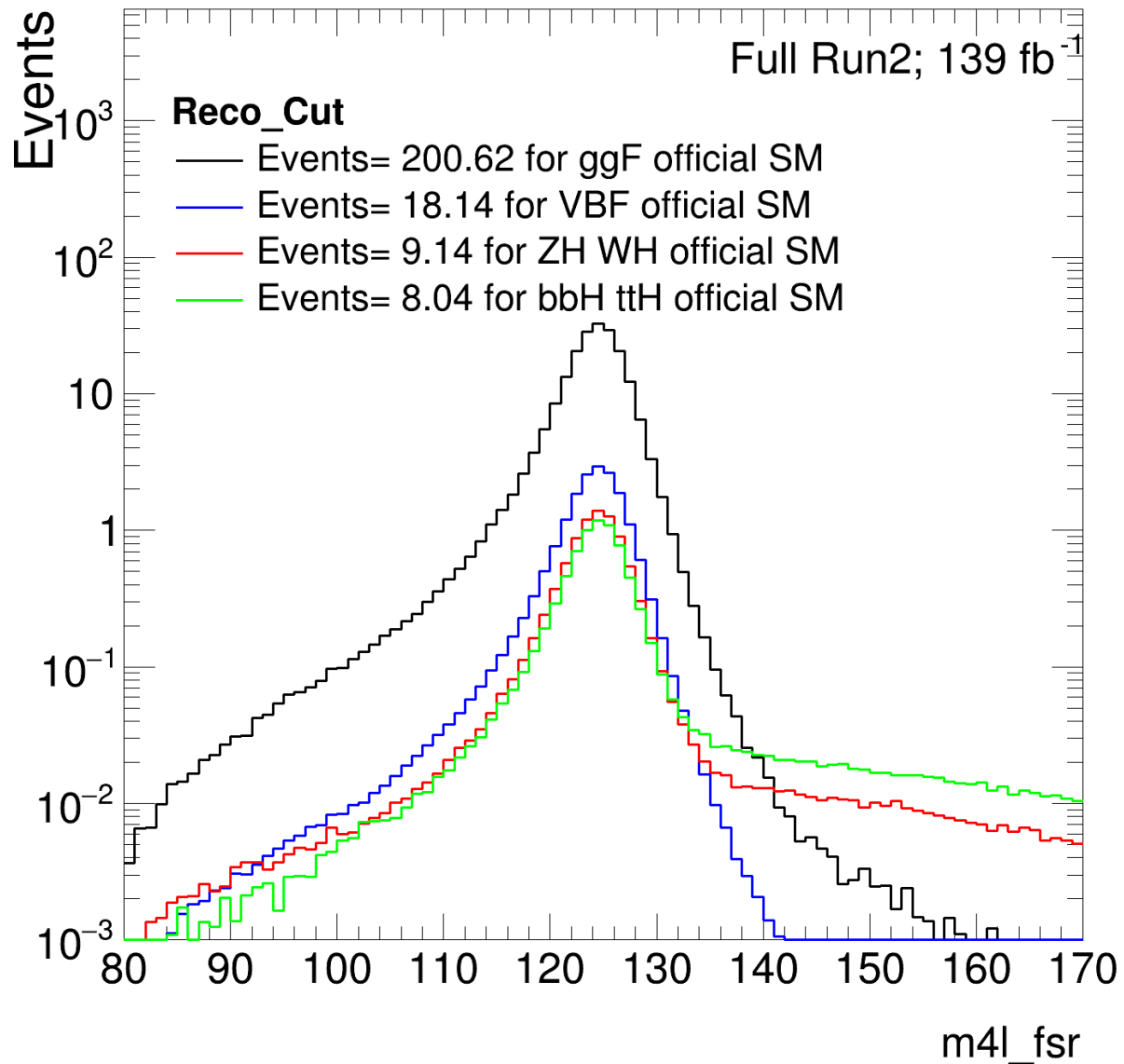

➤ Reco selection without mass window:

ggF	200.62
VBF	18.14
VH	9.14
bbH ttH	8.04

• After mass window ($105 < m_{4l_fsr} < 160$)

ggF	199.24 (99.3% efficiency)
VBF	18.02 (99.3)
VH	8.98 (98.2)
bbH ttH	7.84 (97.5)

• After mass window ($115 < m_{4l_fsr} < 130$)

ggF	190.42 (94.9%)
VBF	17.22 (94.9%)
VH	8.26 (90.4%)
bbH ttH	6.92 (86.1%)

Official SM sample vs. new LO SM sample (No Cut)

