

Drift chamber

Linghui Wu, Guang Zhao, Gang Li, Yubing Zhao, Xiaohui Qian, Wei Wei,
Mingyi Dong

2024.3.8

Updated parameters

R extension	600-1800mm
Length of outermost wires ($\cos\theta=0.85$)	5800mm
Thickness of inner CF cylinder: (for gas tightness, no load)	200 μm (0.08% X_0)
Thickness of outer CF cylinder: (for gas tightness, no load)	300 μm (0.13% X_0)
Outer CF frame structure:	Equivalent CF thickness: 1.8 mm (0.77% X_0)
Thickness of end Al plate	25mm (28% X_0)
Cell size:	$\sim 18 \text{ mm} \times 18 \text{ mm}$
Cell number	27623
Diameter of field wire (Al coated with Au)	60 μm
Diameter of sense wire (W coated with Au)	20 μm
Ratio of field wires to sense wires	3:1
Gas mixture	He/ $i\text{C}_4\text{H}_{10}$ =90:10
Gas + wire material	0.16% X_0

	Higgs	Z-pole
B-field (T)	3	2
Performance		
material budget barrel (X0)	1.14%	1.14%
material budget endcap (X1)	28%	28%
Npoints per full track	66	66
point resolution in $r\phi$ (μm)	100	100
point resolution in r_z (μm)	2000	2000
momentum resolution normalised: $\sigma(1/pT) = a \pm b/pT$	$2.1 \times 10^{-5} \pm 0.77 \times 10^{-3}/pT$	$3.2 \times 10^{-5} \pm 1.16 \times 10^{-3}/pT$
a (1/GeV)	2.1×10^{-5}	3.2×10^{-5}
b	0.77×10^{-3}	1.16×10^{-3}
K/ π separation power @ 20GeV	3.1 σ	3.1 σ
Hit rate (maximum)		70.4kHz/cell
Occupancy (maximum)		10.6%
Readiness		
mechanical design	Design (discussed with companies) FEA show structure is stable, design is reasonable	
electronics	Readout scheme (discussed with electronics group)	
power consumption	FEE: 100mW/ch, 1381.2 kW/end plate	
cooling	Air cooling	

Mechanical

Overall design

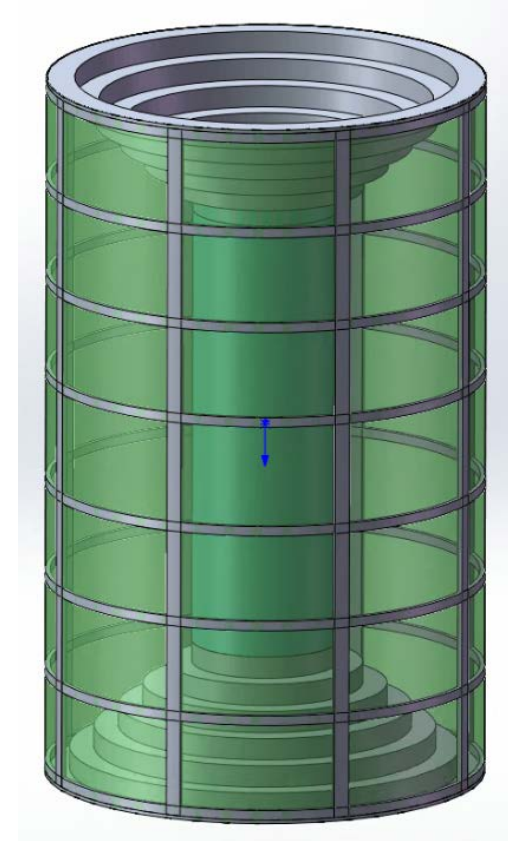
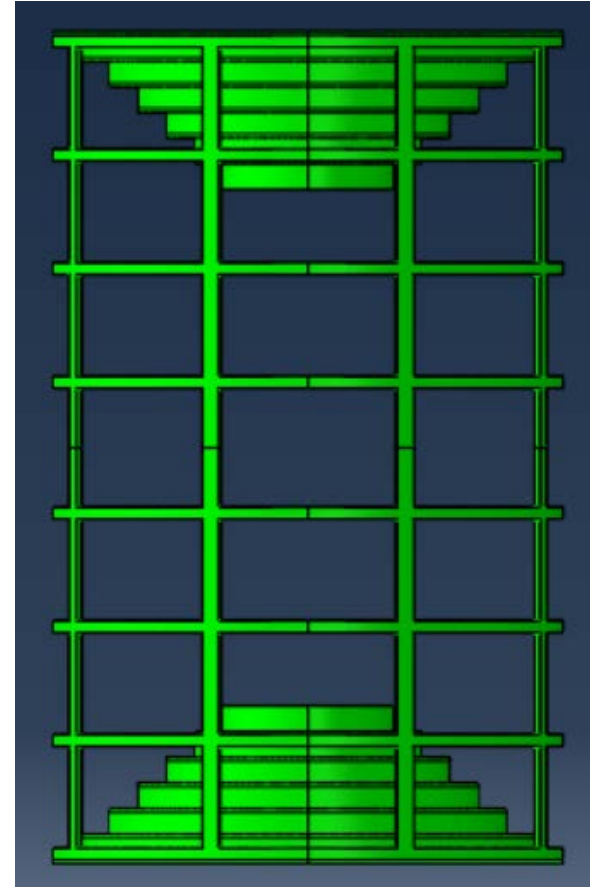
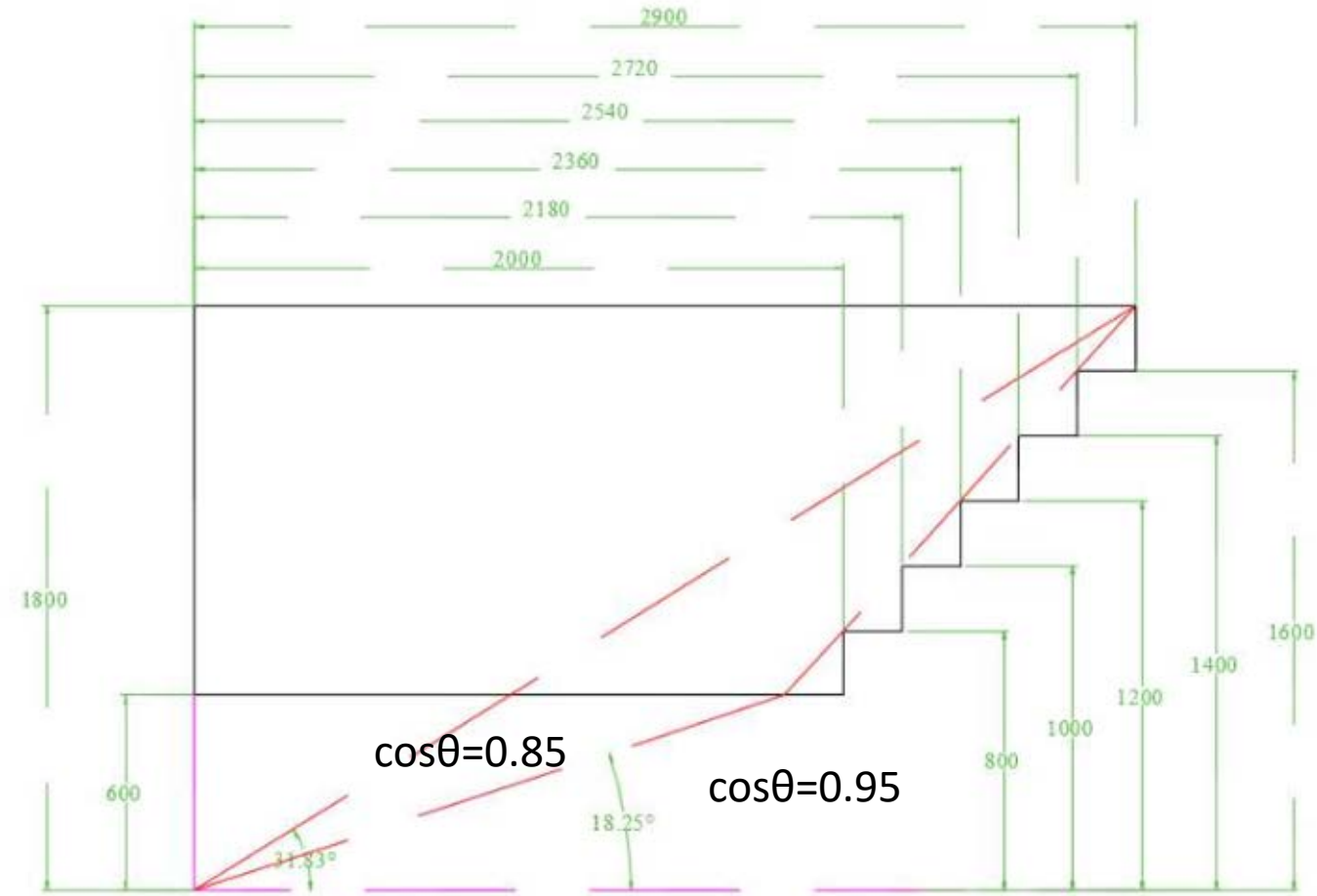

- 框架对称支撑结构：8条立柱，8条水平环
- 总高2900*2
- 外筒直径3600mm，内直径1200mm；
- 端面板厚度25mm

Wire tension

	cell number /step	length	single sense wire tension(g)	Single field wire tension(g)	total tension /step (kg)
	2684	4000	43.29	66.52	651.78
	3452	4360	51.43	79.03	995.95
	4220	4720	60.28	92.62	1426.88
	4988	5080	69.82	107.29	1953.63
	5756	5440	80.07	123.03	2585.27
	6524	5800	91.02	139.85	3330.85
total	27623				10944

Diameter of field wire (Al coated with Au) : 60μm
 Diameter of sense wire (W coated with Au): 20μm
 Sag = 280 μm

Meet requirements of stability condition:

$$T > \left(\frac{VLC}{d}\right)^2 / (4\pi\epsilon_0)$$

荷载

丝张力

	cell number/step	length	Sense wire tension(g) /cell	Field wire tension(g) /cell	Sense wire tension (kg)	Field wire tension (kg)	total tension(kg) /step
	2684	4000	43.29	66.52	116.19	535.59	651.78
	3452	4360	51.43	79.03	177.55	818.41	995.95
	4220	4720	60.28	92.62	254.37	1172.51	1426.88
	4988	5080	69.82	107.29	348.27	1605.36	1953.63
	5756	5440	80.07	123.03	460.87	2124.39	2585.27
	6524	5800	91.02	139.85	593.79	2737.07	3330.85
total	27623				1951	8993	10944

7075航空铝屈服强度:505MPa

	Young's Modulus	Poisson's Ratio
1	71700000000	0.33

复合材料本构参数 密度1.6

Data						
	E1	E2	Nu12	G12	G13	G23
1	320000000000	7000000000	0.29	4200000000	4200000000	2700000000

复合材料失效参数

Data							
	Ten Stress Fiber Dir	Com Stress Fiber Dir	Ten Stress Transv Dir	Com Stress Transv Dir	Shear Strength	Cross-Prod Term Coeff	Stress Limit
1	2000000000	600000000	22000000	100000000	50000000	0	0

材料参数

性能	东丽M55J复合材料	
	室温	
0度拉伸强度, Mpa	2000	ASTM D3039
0度拉伸模量, GPa	320	
泊松比	0.29	
90度拉伸强度, Mpa	22	
90度拉伸模量, GPa	7.0	
弯曲强度, Mpa	1000	
弯曲模量, GPa	230	
0度压缩强度, Mpa	600	ASTM D6641
0度压缩模量, GPa	300	
90度压缩强度, Mpa	100	
90度压缩模量, GPa	6.5	
ILSS, Mpa	50	ASTM D2344
面内剪切强度, Mpa	50	ASTM D3518
面内剪切模量, GPa	4.2	

M55J为高模量

有限元模型 (discussion with company)

竖梁
复合材料:
125*40mm,
壁厚3.2mm
总重: 78kg

环梁
复合材料:
80*40mm
壁厚3.2mm
总重: 111kg

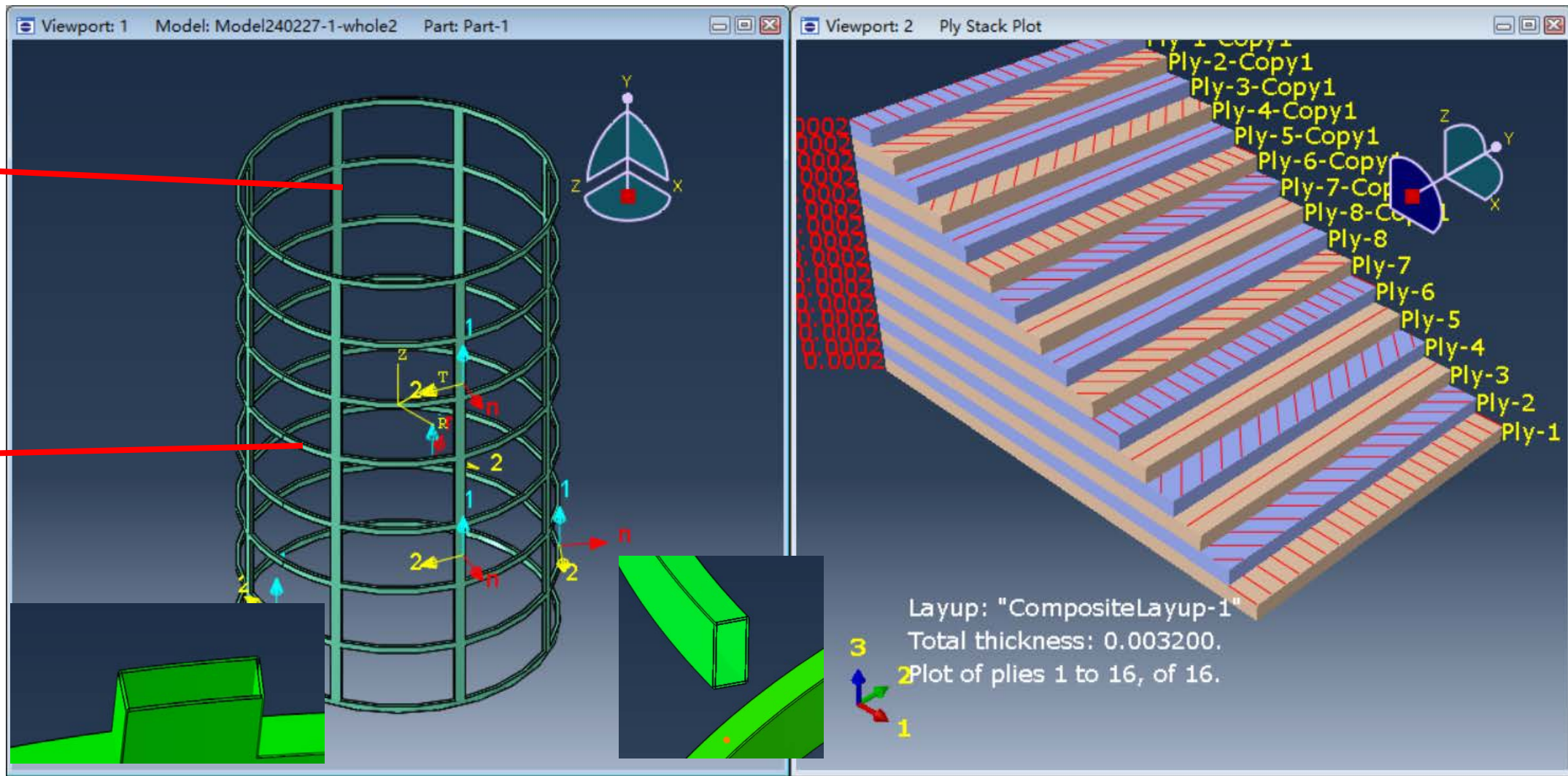

复合材料厚度3.2mm, 每层厚度0.2mm(100um+100um), 总共16层
实际材料方向和制作工艺已和厂家沟通, 实现没有问题。参数可以进一步优化。

端面板拉力+轴向自重荷载:

端面板厚度25mm, 应力
20.9MPa, 变形2.5mm, 框
架变形1.4mm

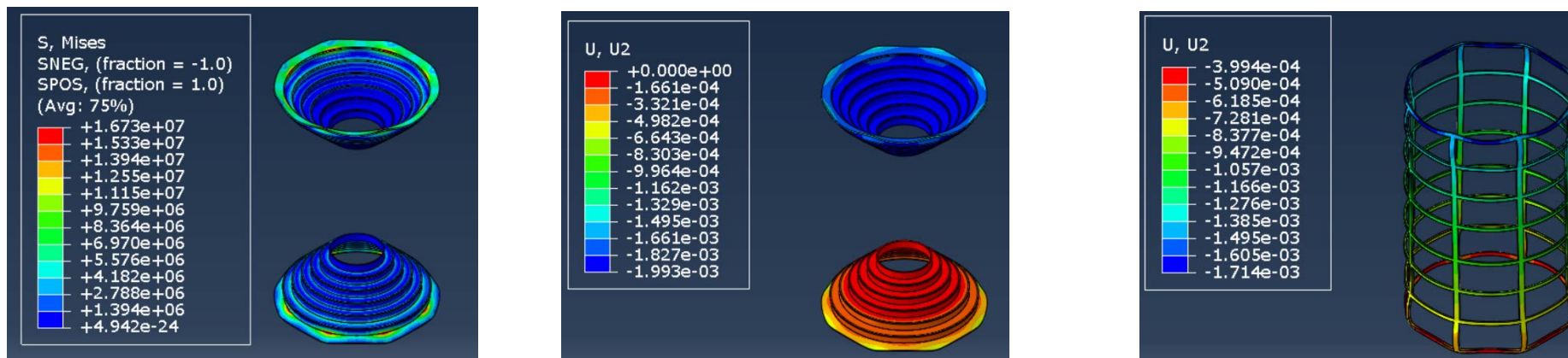
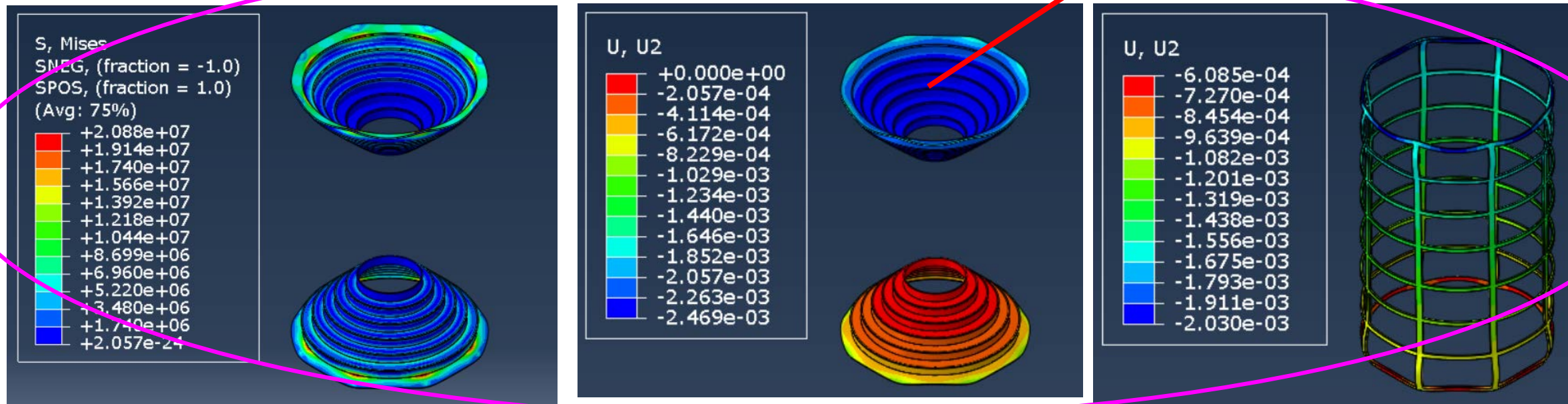

端面板厚度
30mm, 应力
16.7MPa, 变
形2.0mm, 框
架变形1.3mm

复核材料支撑结构拉力荷载（端面板厚度25mm）

自重和轴向平行

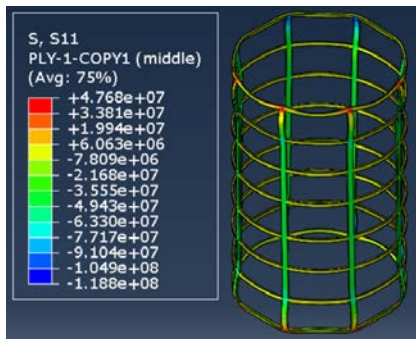
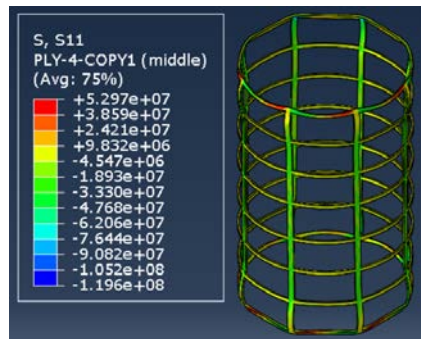
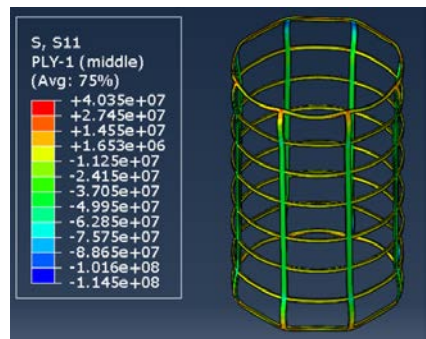

复合材料0度方向最大应力
53MPa，位于第-4层

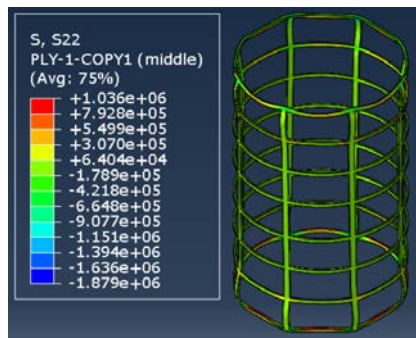
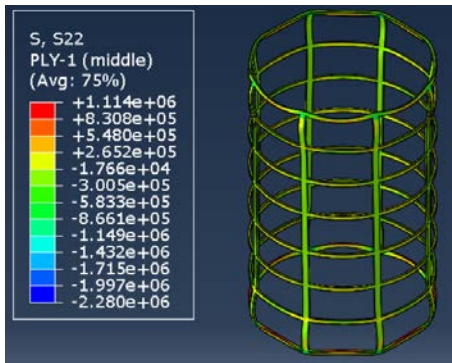

复合材料90度方向最大应力
1.1MPa，位于第1层

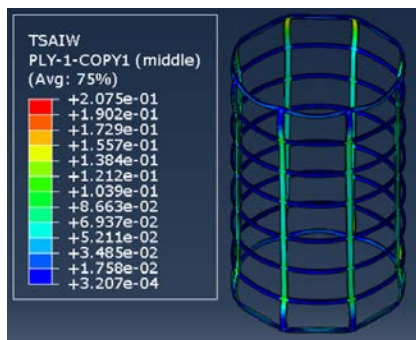
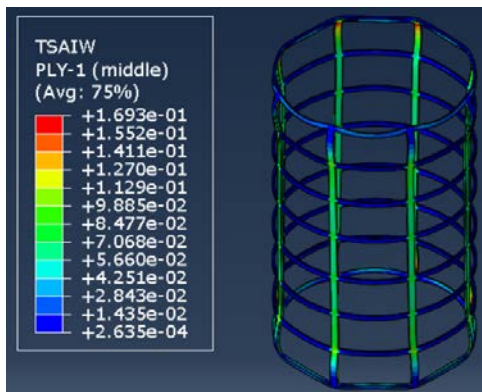

TSAIW失效准则，最大系数为
0.21，位于第16层（等于1表示
失效）。结构强度破坏具有约
5倍安全系数

支撑结构在拉力荷载下，TSAIW失效系数为0.21（安全系数约5倍）

复核材料支撑结构拉力荷载（端面板厚度25mm）

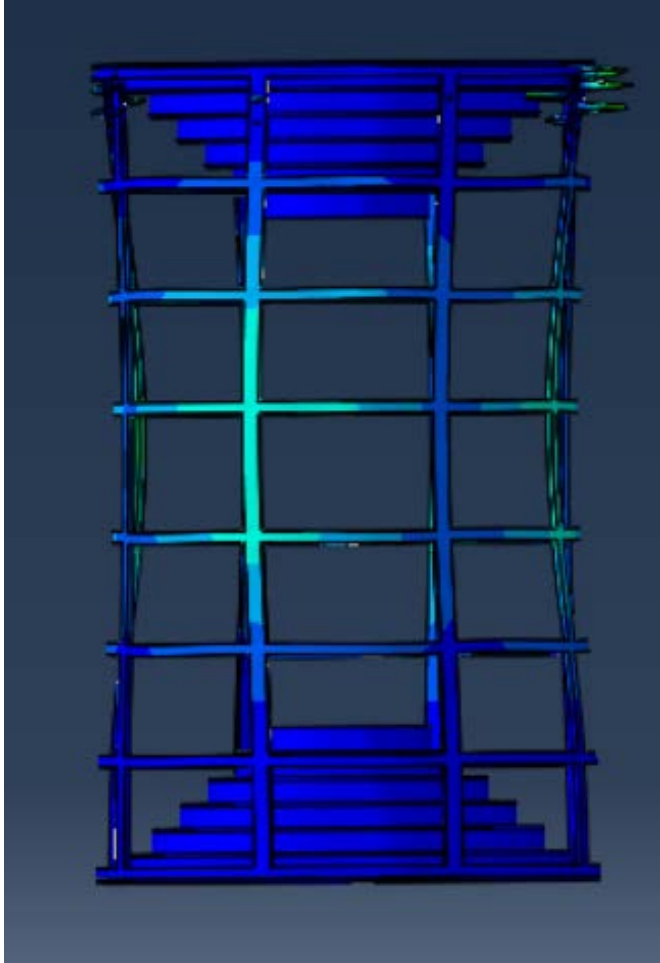

竖直方向自重，
失稳系数~12

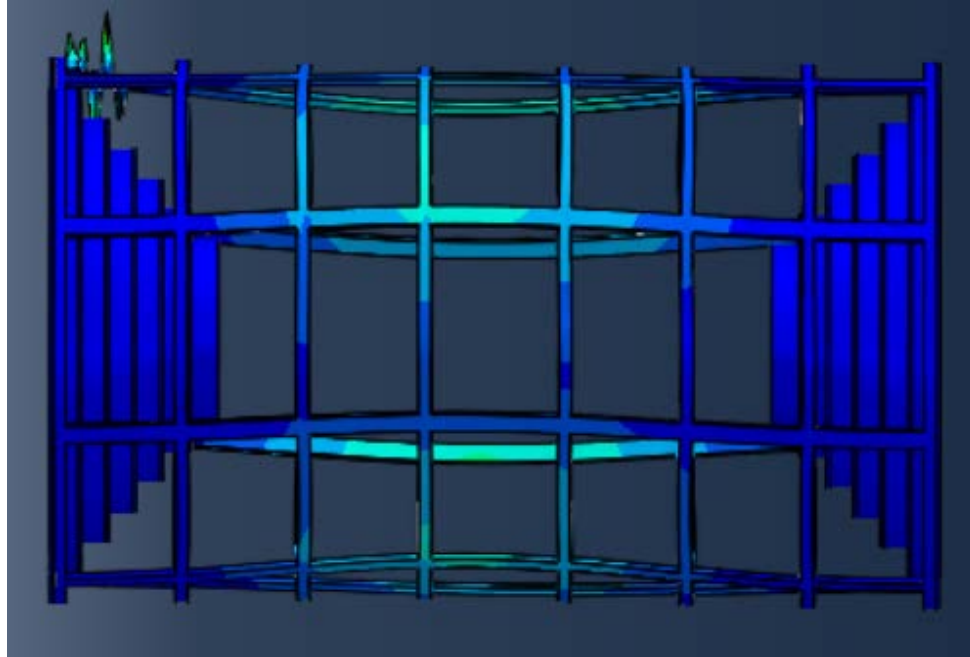

水平方向自重，
失稳系数~14

线性失稳就具有10倍以上
安全系数。

Performance

Waveform-based full simulation

Develop sophisticated software tools for DC PID simulation

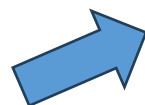
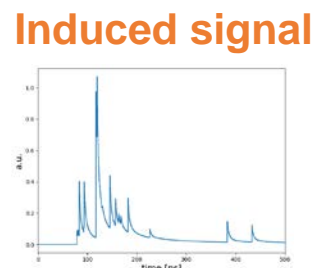
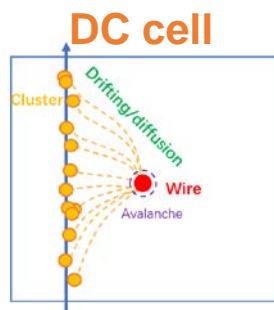
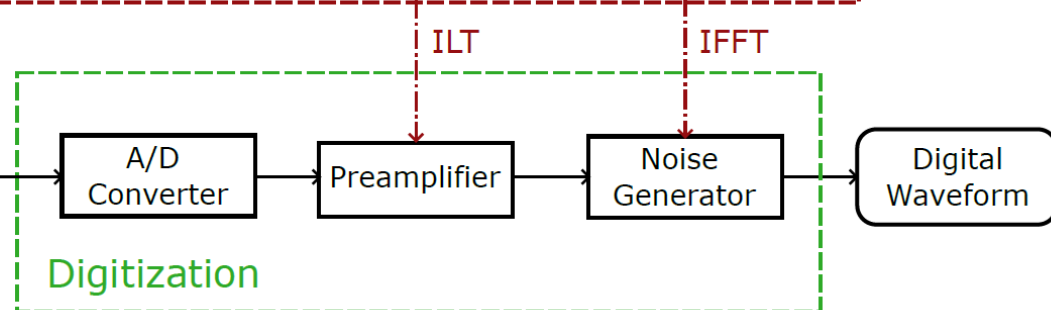
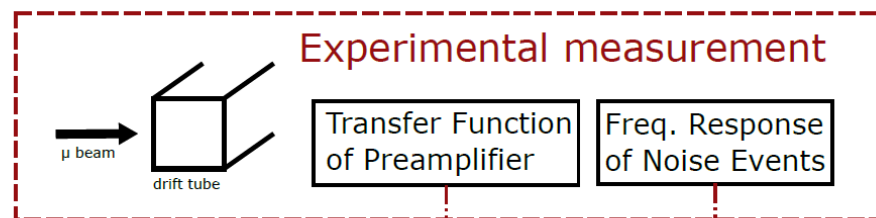
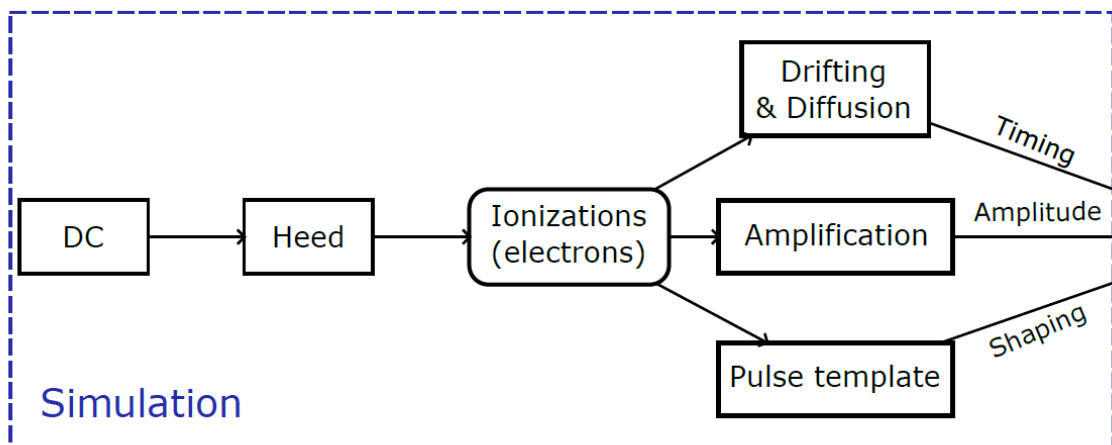

Tuned MC is comparable to data

Preamplifier

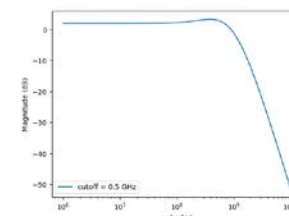

Noise

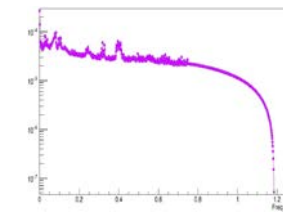

Waveform

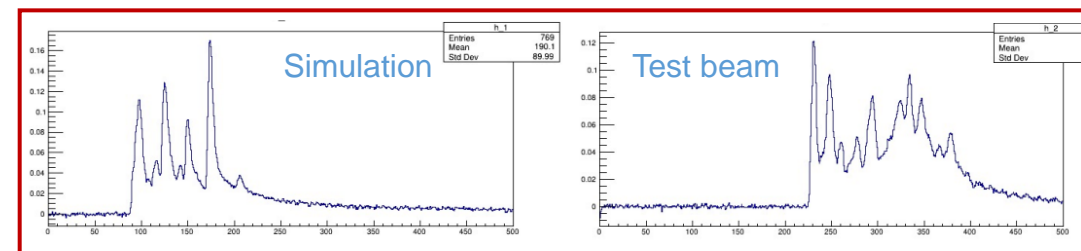
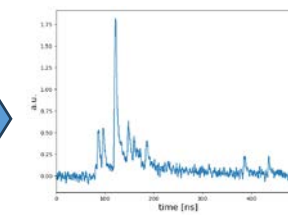

Traditional reconstruction algorithm

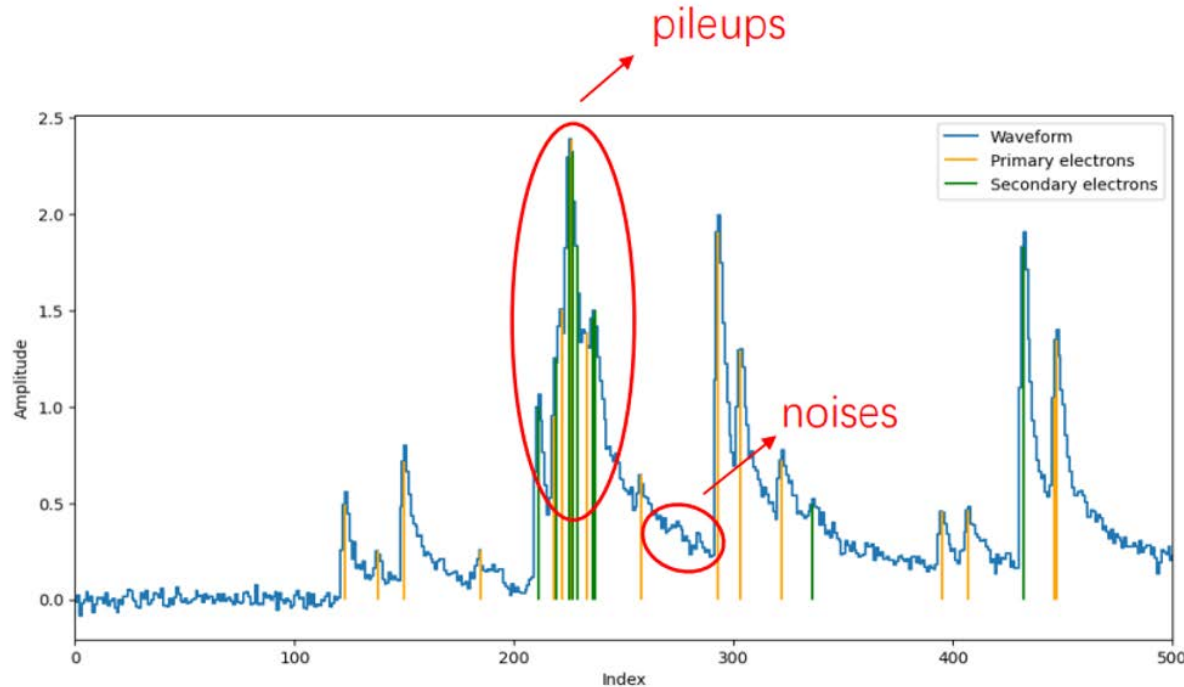

Simulated waveform of a DC cell. Orange lines are primary electrons. Green lines are secondary electrons.

Reconstruction: Each primary and secondary electrons forms a peak in the waveform. Need to determine the # of primary peaks.

Peak finding: Detect all electron peaks

- Taking 1st and 2nd order derivatives
- Peak detection by threshold passing

Clusterization: Merge electrons to form clusters

- Merge peaks within $[0, t_{\text{cut}})$
- The t_{cut} is related to diffusion

- Pros: Fast and easy to implement

- Cons: Suboptimal efficiency for highly pile-up and noisy waveforms

➡ **Machine learning**

ML reconstruction and PID performance

- Supervised model for MC simulation
 - Full labels in MC
 - Model structure
 - LSTM-based peak finding
 - DGCNN-based clusterization
- Semi-supervised model for data
 - Lack of labels in data
 - Domain adaptation to map data to MC sample

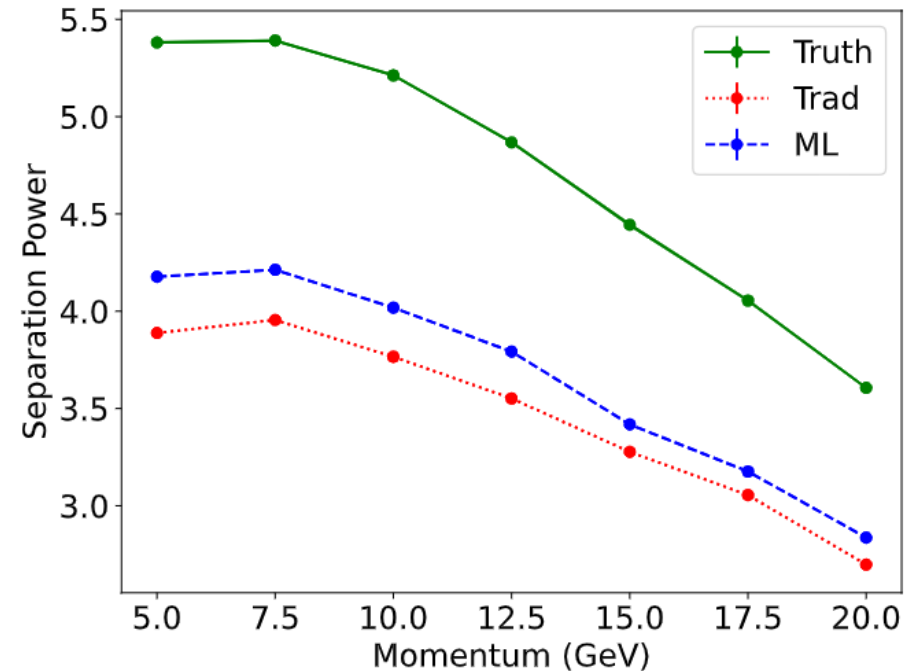

- **For 1m track, close to 3σ K/ π separation @ 20 GeV/c**
- **~10% improvement with ML (equivalent to a detector with 20% larger radius)**

PID performance

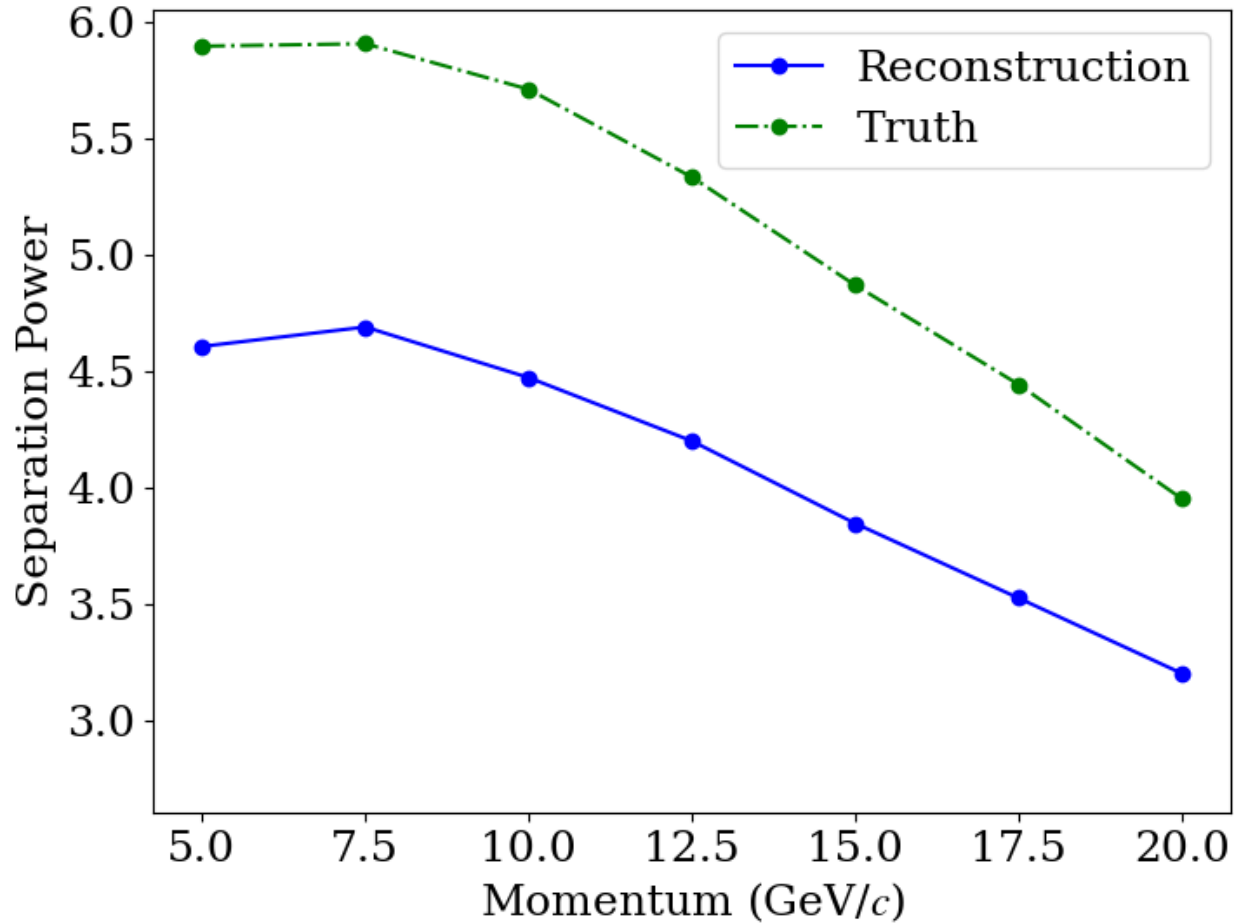

- 1.2 m track length
- For 20 GeV/c K/π ,
- Separation power: 3.1σ