

CEPC Beam Backgrounds and MDI

Haoyu SHI

(On behalf of the CEPC MDI Working Group)



中國科學院高能物理研究所
Institute of High Energy Physics
Chinese Academy of Sciences

Content

- **Introduction**
- **Beam Induced Backgrounds Estimation**
- **The Design of the Key Components in the MDI Region**
- **Research team and working plan**
- **Summary**

Introduction

- This talk relates to the Ref-TDR Chapter 3: Beam Backgrounds and MDI.
- There will be several topics in this chapter and talk, mainly including
 - Beam induced background estimation
 - MDI
 - The Layout of the IR Region
 - The Design of key components
 - Central beam pipe
 - LumiCal

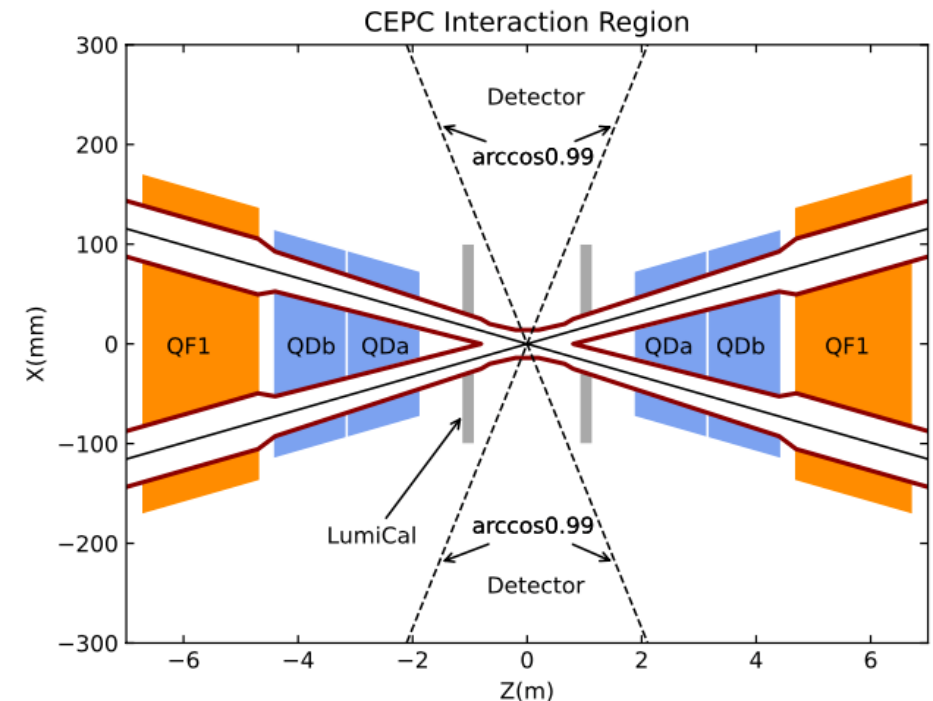

Content

- Introduction
- **Beam Induced Backgrounds Estimation**
 - Requirement
 - Source of the beam induced backgrounds and simulation methods
 - Mitigation of the backgrounds and Loss Map at the Interaction Region
 - Estimation of the impacts on MDI Region
 - Benchmark and Validation
- The Design of the Key Components in the MDI Region
- Research team and working plan
- Summary

Requirement

- Reasonable Estimation of Beam induced background level

- Understanding of Beam induced Backgrounds
- Based on the 50-MW design of CEPC Accelerator TDR

- Estimate the Noise on Detector(Backgrounds)

- Hit Rate/Occupancy

- Estimate the Radiation Environment(Backgrounds + Signal)

- Radiation Damage of the Material(Detector, Accelerator, Electronics, etc...)
- Radiation Harm of the human beings and environment

- Mitigation on Backgrounds.

	Higgs	Z	W	t \bar{t}
Number of IPs	2			
Circumference (km)	100.0			
SR power per beam (MW)	50			
Half crossing angle at IP (mrad)	16.5			
Bending radius (km)	10.7			
Energy (GeV)	120	45.5	80	180
Energy loss per turn (GeV)	1.8	0.037	0.357	9.1
Damping time $\tau_x/\tau_y/\tau_z$ (ms)	44.6/44.6/22.3	816/816/408	150/150/75	13.2/13.2/6.6
Piwinski angle	4.88	29.52	5.98	1.23
Bunch number	446	13104	2162	58
Bunch spacing (ns)	355 (53% gap)	23 (10% gap)	154	2714 (53% gap)
Bunch population (10^{11})	1.3	2.14	1.35	2.0
Beam current (mA)	27.8	1340.9	140.2	5.5
Phase advance of arc FODO ($^\circ$)	90	60	60	90
Momentum compaction (10^{-5})	0.71	1.43	1.43	0.71
Beta functions at IP β_x, β_y (m/mm)	0.3/1	0.13/0.9	0.21/1	1.04/2.7
Emittance ϵ_x/ϵ_y (nm/pm)	0.64/1.3	0.27/1.4	0.87/1.7	1.4/4.7
Betatron tune ν_x/ν_y	445/445	317/317	317/317	445/445
Beam size at IP σ_x/σ_y (um/nm)	14/36	6/35	13/42	39/113
Bunch length (natural/total) (mm)	2.3/4.1	2.7/10.6	2.5/4.9	2.2/2.9
Energy spread (natural/total) (%)	0.10/0.17	0.04/0.15	0.07/0.14	0.15/0.20
Energy acceptance (DA/RF) (%)	1.6/2.2	1.0/1.5	1.05/2.5	2.0/2.6
Beam-beam parameters ξ_x/ξ_y	0.015/0.11	0.0045/0.13	0.012/0.113	0.071/0.1
RF voltage (GV)	2.2	0.1	0.7	10
RF frequency (MHz)	650			
Longitudinal tune ν_z	0.049	0.032	0.062	0.078
Beam lifetime (Bhabha/beamstrahlung) (min)	40/40	90/930	60/195	81/23
Beam lifetime requirement (min)	20	81	25	18
Hourglass Factor	0.9	0.97	0.9	0.89
Luminosity per IP ($10^{34} \text{ cm}^{-2} \text{ s}^{-1}$)	8.3	192	26.7	0.8

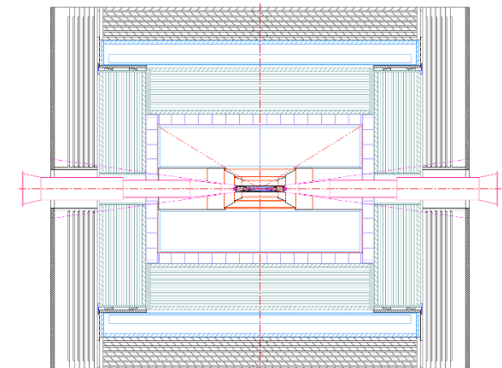

Source and Simulation Steps

- Single Beam
 - Touschek Scattering
 - Beam Gas Scattering(Elastic/inelastic)
 - Beam Thermal Photon Scattering
 - Synchrotron Radiation
- Luminosity Related
 - Beamstrahlung
 - Radiative Bhabha Scattering
- Injection(Will be considered future)

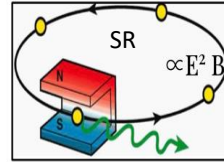

A. Natchii

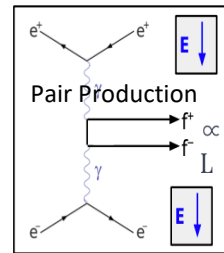

Photon BG

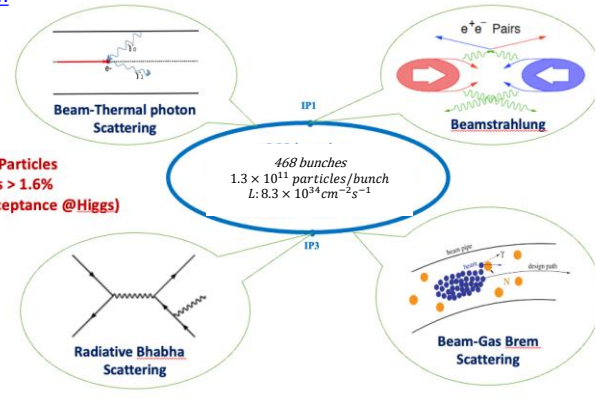

Beam Loss BG

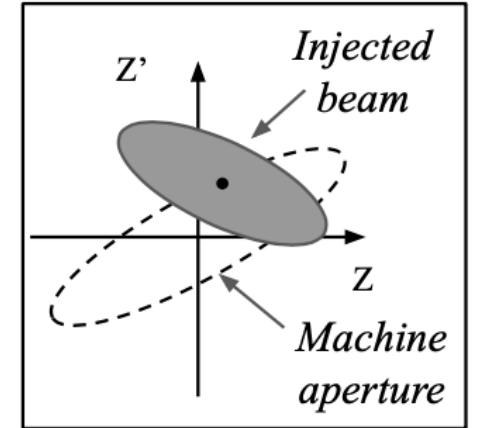

Injection BG

Steps of beam backgrounds simulation

Multi-Turn tracking for single beam losses



Simulation sources separately

Mitigation Methods

- We learnt that migration of the background is necessary from both other experiments and our CDR experience. Therefore, the mitigation methods were implemented since the beginning of TDR Phase
- Collimators were used to mitigate IR loss of Single Beam.
 - 16 sets of collimators were implemented for MDI purpose
 - ~20 sets of collimators were implemented for Passive Machine Protection but will also be benefit for Beam Backgrounds mitigation.
 - With Collimators, multi turn beamstrahlung and radiative Bhabha loss particles have basically been shielded outside the interaction region.
- Shielding at both ends of the yoke with 10cm Paraffin.

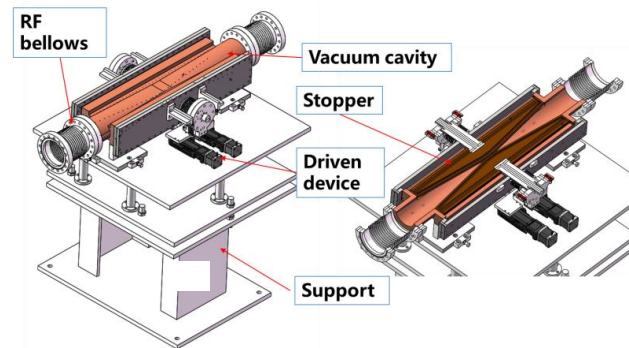
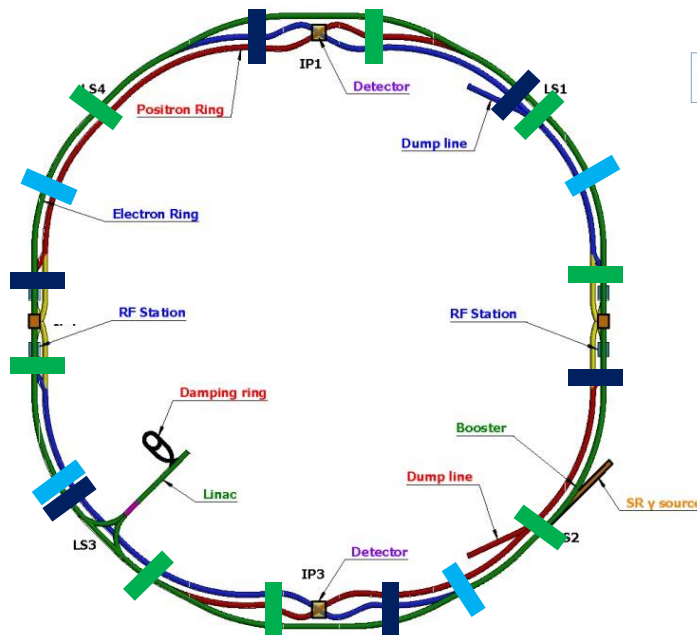

- for H betatron collimator
- for momentum collimator
- for vertical collimator

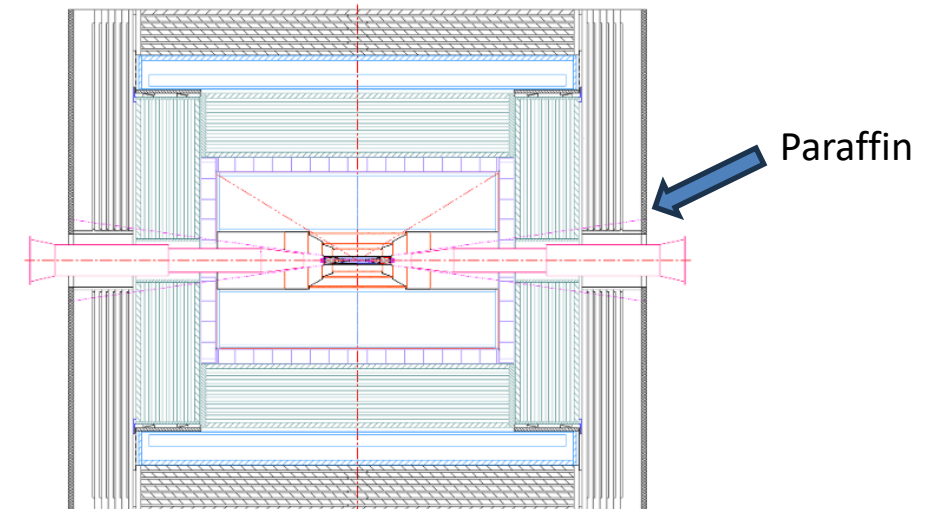

Loss Map @ IR

- Errors implemented

- High order error for magnets
- Beam-beam effect

$$\text{Loss Rate} = \frac{\text{Loss Number}}{\text{Loss Time}} = \frac{\text{Bunch number} * \text{Particles per Bunch} * (1 - e^{-1})}{\text{Beam Lifetime}}$$

- Currently we have the results for Higgs and Z-pole, Higgs < 100 MHz(SuperKEKB standards)

@Higgs

@Z-pole

Acceptable

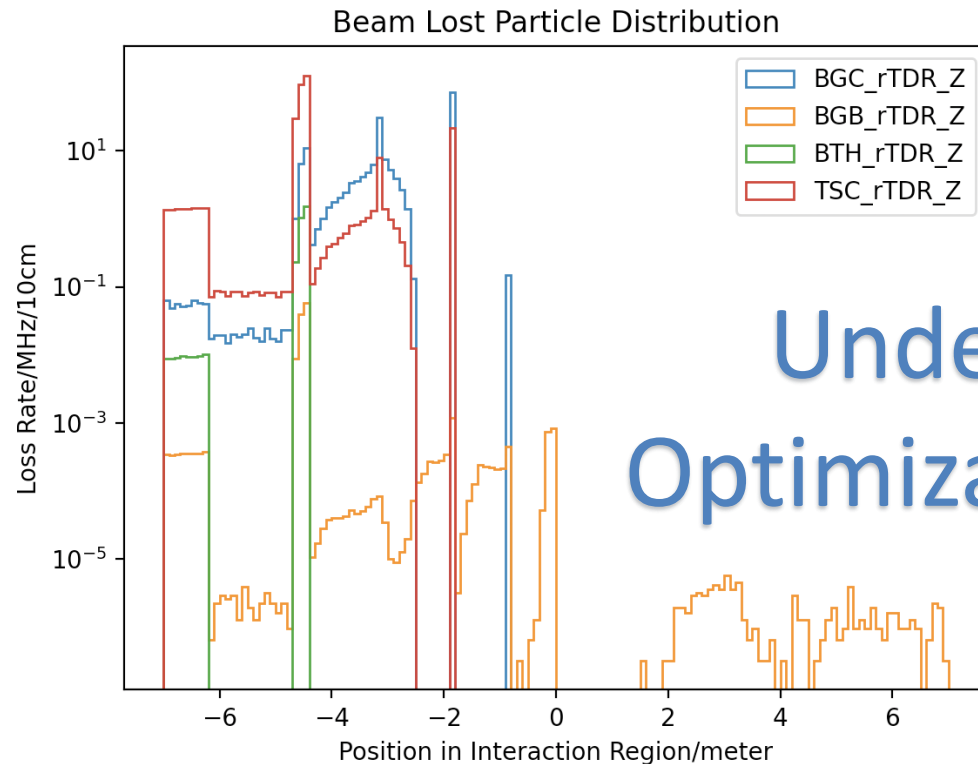
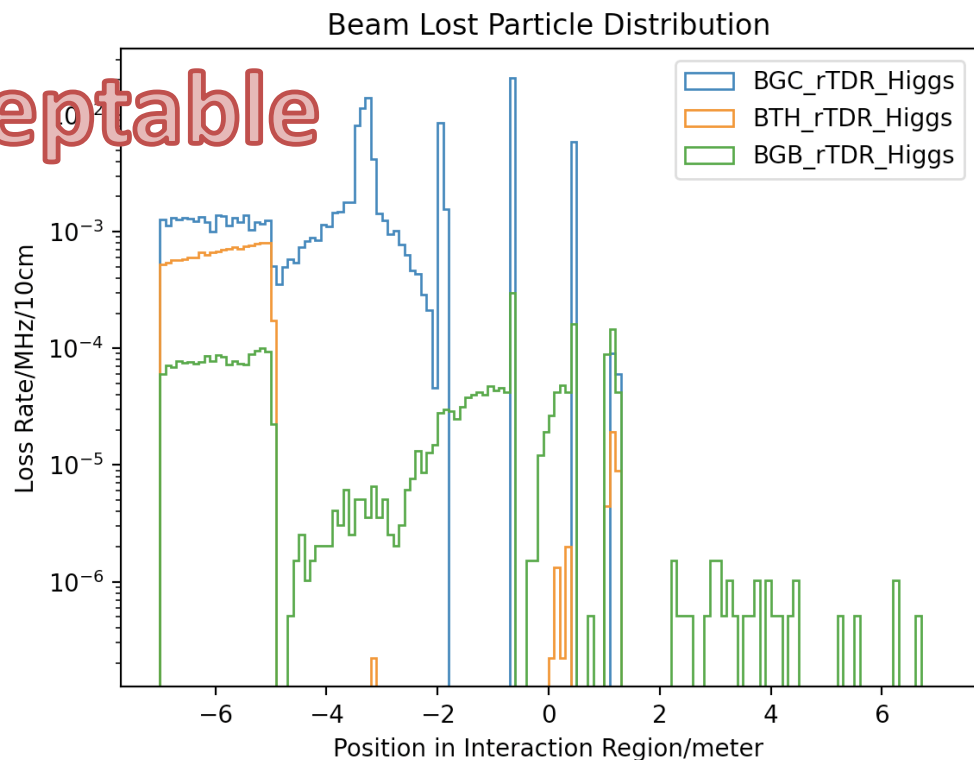

Under Optimization

Loss Map @ IR

- Errors implemented

- High order error for magnets
- Beam-beam effect

$$Loss\ Rate = \frac{Loss\ Number}{Loss\ Time} = \frac{Bunch\ number * Particles\ per\ Bunch * (1 - e^{-1})}{Beam\ Lifetime}$$

- Currently we have the results for Higgs and Z-pole, Higgs < 100 MHz(SuperKEKB standards)

@Higgs

Acceptable

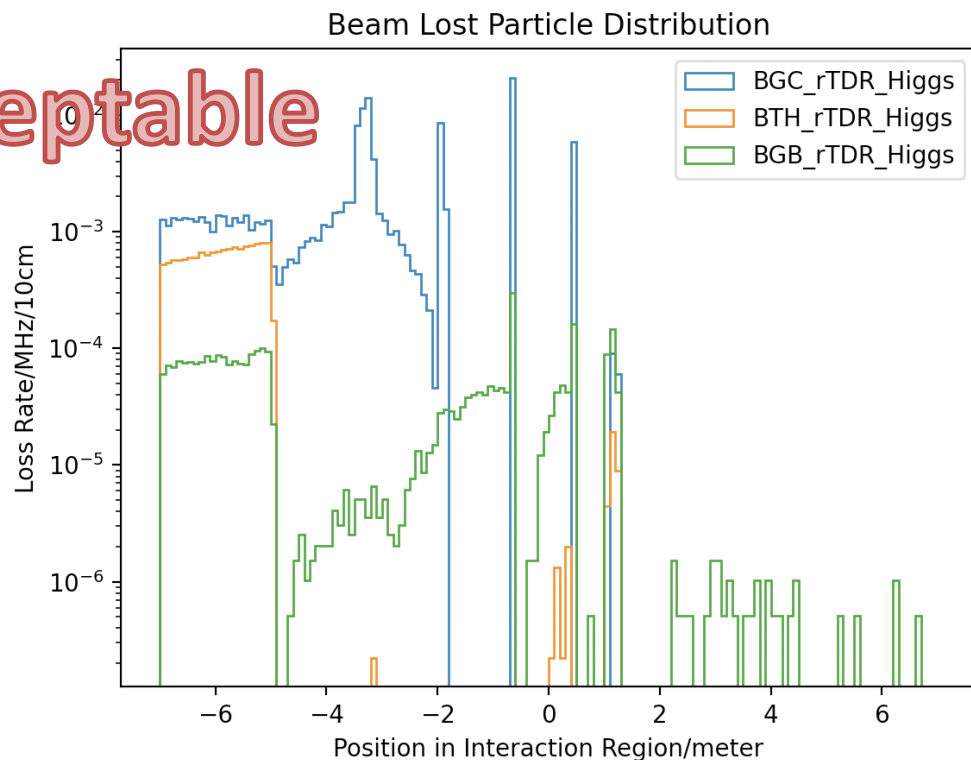

Rates of BIB Considered @ Higgs

	50MW Higgs, 355ns/BX
Pair Production	~1.82GHz in IR
Beam Thermal Photon	~0.36MHz/beam in IR
Beam Gas Bremsstrahlung	~0.04MHz/beam in IR
Beam Gas Coulomb	~0.24MHz/beam in IR

Vacuum Level: 10⁻⁷ Pa, H₂

Estimation of Impacts in the MDI

- We already got the preliminary version of the estimation of the beam induced backgrounds level at Higgs Mode.
 - Assume that operation time 3600h/yr

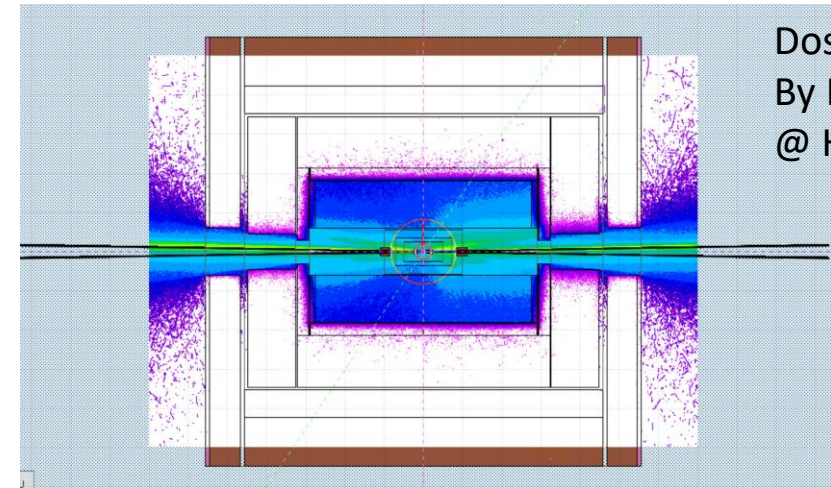

Dose Level
By Pair production
@ Higgs

Sub-Detectors	Max Hit Density(/cm ² /BX)	Max Hit Rate(MHz/cm ²)	Occupancy	Absorbed Dose(Gy/yr)
Vertex	0.437	0.6128	0.22e-4(Pixel)	1.08e4
ITK	1.848	2.5872	2.5e-4(Sensor)	66.1
TPC	0.142	0.4	2.8e-4	93.7
OTK - Endcap	0.475	0.665		3.57
ECal	-	0.3/bar	0.58e-2	0.165
Hcal – Endcap	-	0.05/bar	1.95e-5	0.21

Benchmark and Validation

- BG experiments on BEPCII/BESIII has been done several times.
 - We separated the single beam BG sources using SuperKEKB method and get the detector response from both simulation and experiment.
 - The data/MC ratio has been reduced several order of magnitude due to update of the IR model.
 - Study on beam-beam reduced another ~15% of simulation.
 - Currently, we still have 1~2 order of magnitude differences, more experiments/data and more accurate models are needed.

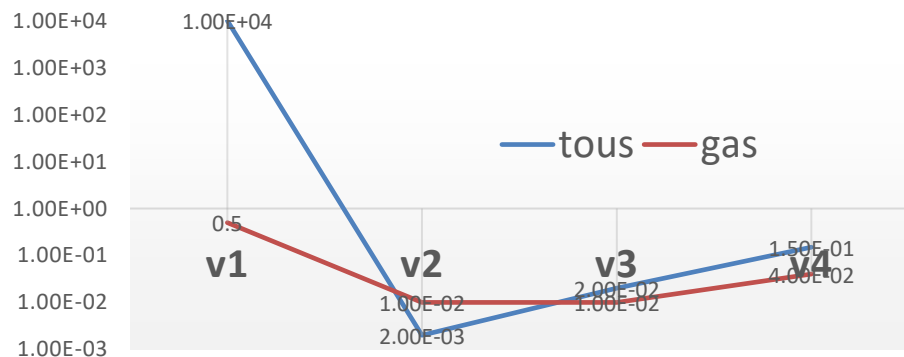

Data/MC ratio improvements on 1st layer MDC

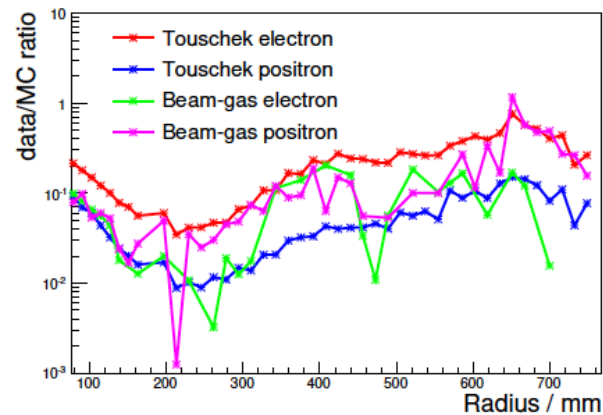

Data/MC ratio in MDC

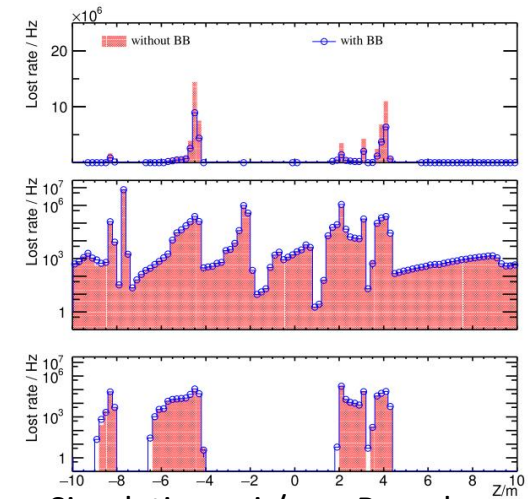

Simulation w.i./w.o. Beambeam

Content

- Introduction
- Beam Induced Backgrounds Estimation
- **The Design of the Key Components in the MDI Region**
 - Requirements
 - Technology survey and our choices
 - Technical challenges
 - Detailed design including electronics, cooling and mechanics
- Research team and working plan
- Summary

Requirement & Main Challenges

- Tight Space of MDI components (cone angle of $\sim 300\text{mrad}$ including the acc. components)
 - Cryo-Modules, cables, LumiCal and other components inside this tight space
 - All design should work at all 4 operation modes
- Low material budget and stable beampipe
 - Low material budget ($< 0.15\% X_0$)
 - Temperature and stress acceptable
- High precision measurement of the luminosity
 - 10^{-4} precision @ Z-pole

Technology survey and our choices

■ Beam pipe

- We performed the survey of other experiments as the table shown below

■ Our Choice:

- 2-layer Be pipe with 20mm inner diameter

- First estimates made with fast simulation and scaling

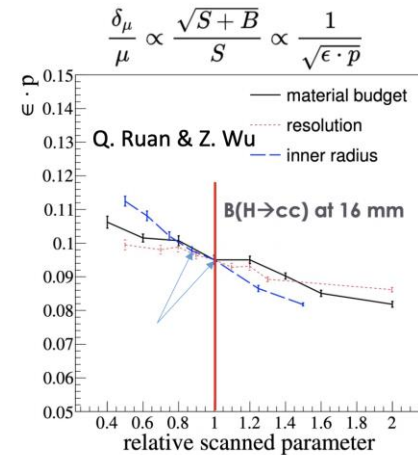

$$\sigma_{d_0}^2 = \sigma_{geom}^2 + \sigma_{MS}^2 = \left(\frac{\sigma_1 r_2}{r_2 - r_1}\right)^2 + \left(\frac{\sigma_2 r_1}{r_2 - r_1}\right)^2 + \sum_{j=1}^{n_{scatt}} (R_j \Delta \theta_j)^2$$

div vs momentum ($\theta=60^\circ$)

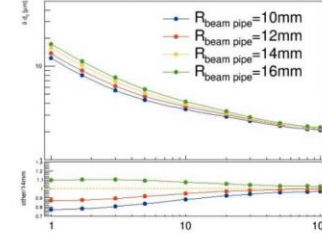

H. Zeng

- Implement the geometry in simulation and run a full analysis to estimate the physics gains

G. Li

Detectors	Material	Inner Diameter/mm	Thickness/mm	Length/m
ATLAS	Beryllium	58	0.8	7.3
CMS		43.4	0.8	1.6
CMS(Second Gen.)		43.4	0.8	3.1
ALICE		38	0.8	6
ALICE(Third Gen)		32	0.8	6
BELLE		30	0.6+0.35	0.17
BELLE-II		20	0.6+0.4	0.17

Detailed design including electronics, cooling and mechanics

■ Be Beam pipe

- Inner Layer with thickness of 0.20mm
- Gap for coolant with thickness of 0.35mm
 - Water chosen as coolant
- Outer Layer with thickness of 0.15mm
- Gold coating with thickness of $\sim 10\mu\text{m}$
- Temperature acceptable for beam pipe itself

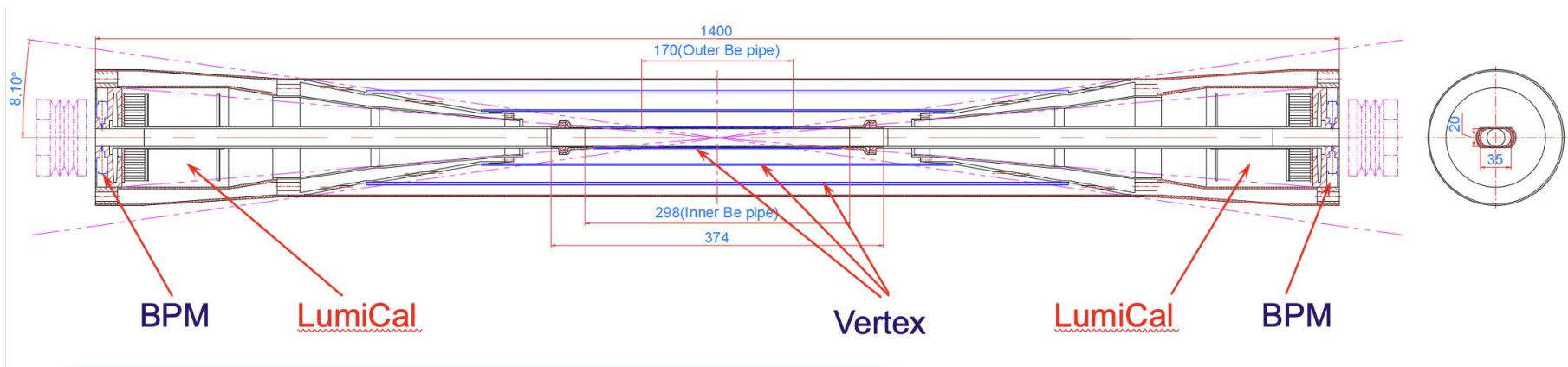
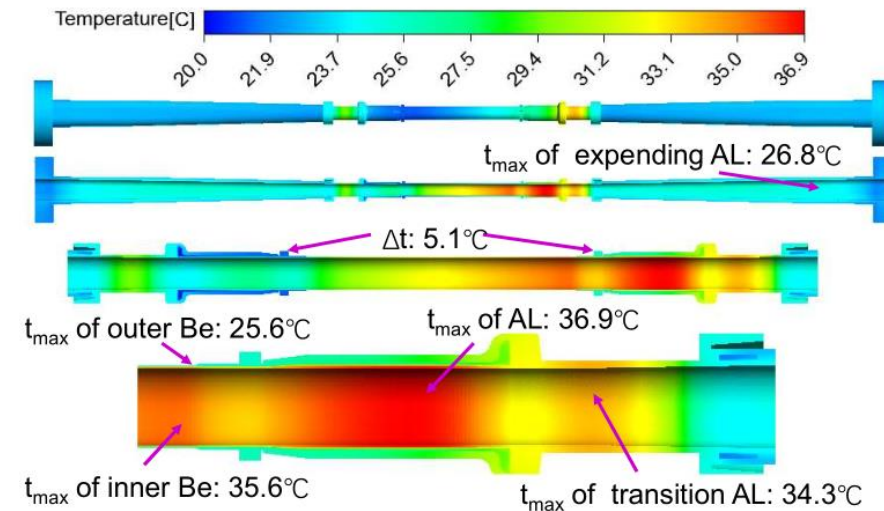
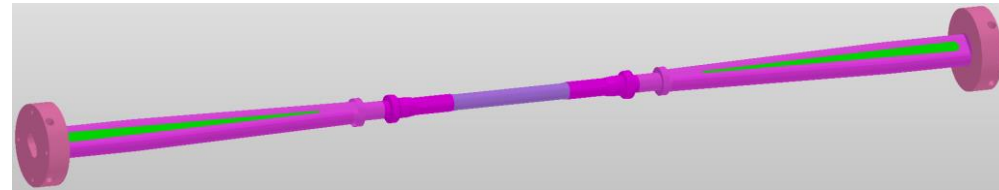

Technology survey and our choices

Luminosity Calorimeter

- ILD/FCC-ee and our CDR design has only crystal

Our Choice

- Si wafer + Crystal
- Moon Cake like design

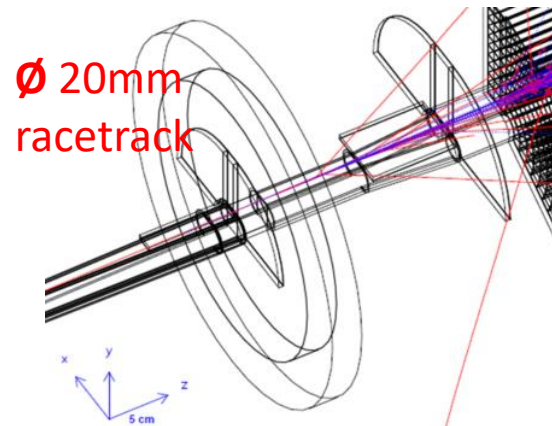
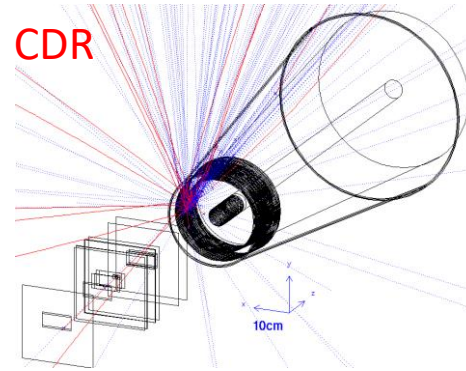
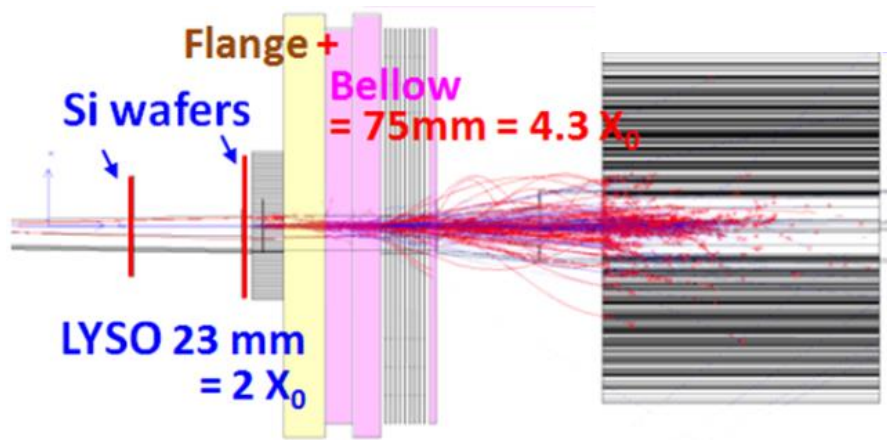

ILD LumiCal

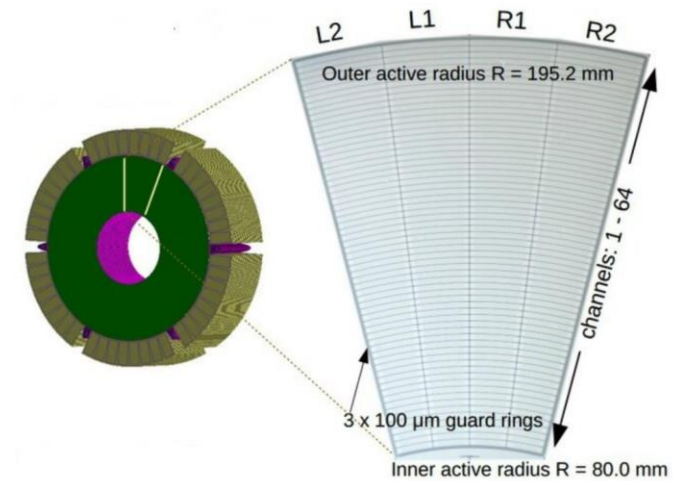

FCC-ee LumiCal

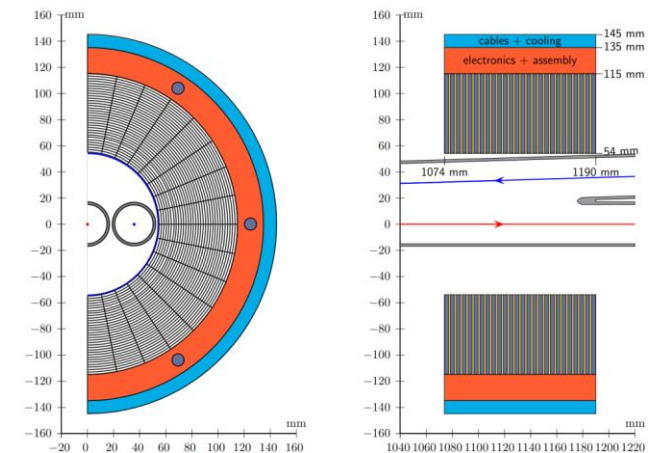

Detailed design including electronics, cooling and mechanics

LumiCal

- 2 parts, Silicon det. and Crystal
 - Silicon Wafer locates at 560mm and 640mm
 - First crystal has a length of 23mm
 - Second crystal has a length of 100mm
- Moon-cake like design
 - Height \sim 39mm, radius \sim 56 mm

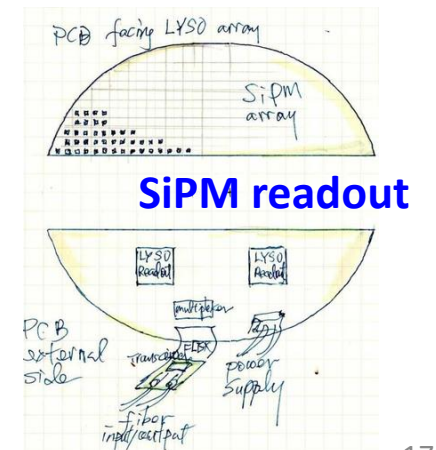
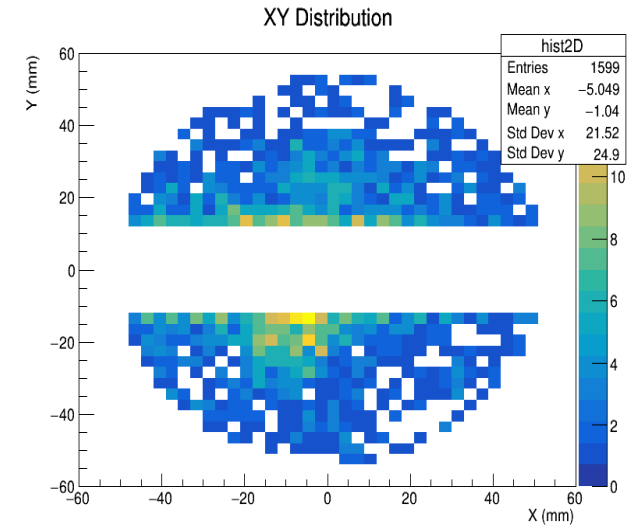
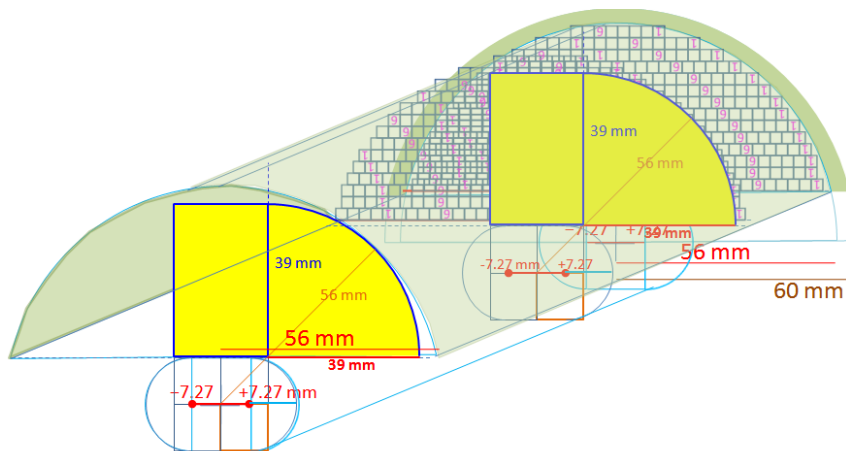
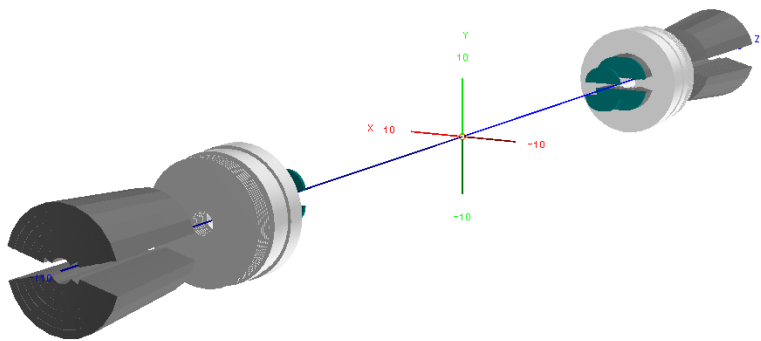

Working plan

	2024.12	2025.6	Beyond Ref-TDR
BG Estimation	Whole Map Estimation on 2 modes, including preliminary thoughts on Mitigation Methods	Whole Map Estimation and Mitigation on 4 modes, including the thoughts on injection backgrounds	Benchmark experiments on BESIII or SuperKEKB
Be beam pipe			Study on Au-Coating Study on Al-Be Welding and Anti-corrosion on Be
LumiCal	Design optimization based on Simulation	Mechanical Design including cable and cooling	Module assembly and Beam Test if possible

Research Team

- The working group consists of many people from different institutions/universities, including
 - IHEP: ~ 20 staff(including colleagues from acc. side), most of them have participated in BEPCII/HEPS/etc., and ~ 7 students
 - IPAS: Suen Hou, participated in LEP, Editor of MDI Chap of CDR
 - NJU: 1 staff, ~10 students, participated in ATLAS
 - JLU: 1 staff, 1 students , participated in BESIII/Belle II
 - NPU: 2 staff, ~4 students
 - VINCA(Serbia): 5 staff, Ivanka Bozovic was the editor of MDI Chap of CDR

Contents of the TDR Document

- Introduction & Requirements(Haoyu)
- Beam Induced Backgrounds(Haoyu)
 - Introduction
 - Shielding Design/mitigation methods
 - Estimation
 - General Noise Level/Dose Level
 - Impacts on Sub-Detectors:
 - » Interaction Region/LumiCal(Haoyu/Renjie/Yilun)
 - » Vertex(Hancen)
 - » Silicon Tracker(Zhan/Dian)
 - » TPC(Xin/Jinxian)
 - » ECal/HCal(Weizheng/Fangyi)
 - Benchmark: Experiments on BESIII(Bin)
- IR Layout(Haoyu/Sha/Quan/Haijing)
- Key design/parameters(beampipe, final focusing, etc.)
 - Central Beampipe(Quan, Haoyu)
 - Final Focusing System, Anti-solenoid(Yingshun)
 - Cryo-Module(Xiangzhen, Xiaochen)
- LumiCal(Suen/Lei/Weiming)
- Thoughts on the Radiation Monitoring System (Haoyu/Guangyi/Zhongjian)
- Summary & Outlook
- Ref. List

Summary

- The tasks of the Beam Backgrounds and MDI are very critical and challenge, including:
 - The design of layout in a very tight space (cone angle of ~ 300 mrad including the acc. components)
 - The design of key components like beam pipe and quad-magnets.
 - The Luminosity Measurement System
 - The Estimation of Beam-induced backgrounds and mitigation methods.
- For the beam induced background estimation, there will be a whole map later this year. Further mitigation and benchmark could be continued together with accelerator colleagues towards the EDR and maybe construction phase.
- For the design of key components, the technical design has been finished last year (published Acc. TDR volume), more engineering effort are needed like manufacture, welding and gold coating for the Be beam pipe, and will be proceeded in future.
- For the LumiCal, the design of the first version has been finished, the simulation and optimization will be finished by the end of this year.



**Thank you for your
attention!**



中國科學院高能物理研究所
Institute of High Energy Physics
Chinese Academy of Sciences

Backup

Tools of Simulation on Beam Induced Backgrounds

- Single Beam
 - Touschek Scattering
 - Beam Gas Scattering(Elastic/inelastic)
 - Beam Thermal Photon Scattering
 - Synchrotron Radiation
- Luminosity Related
 - Beamstrahlung
 - Radiative Bhabha Scattering
- Injection(Will be considered future)

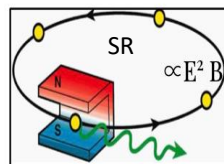

A. Natchii

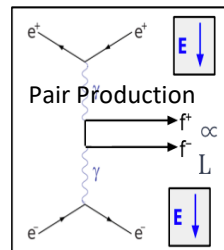

Photon BG

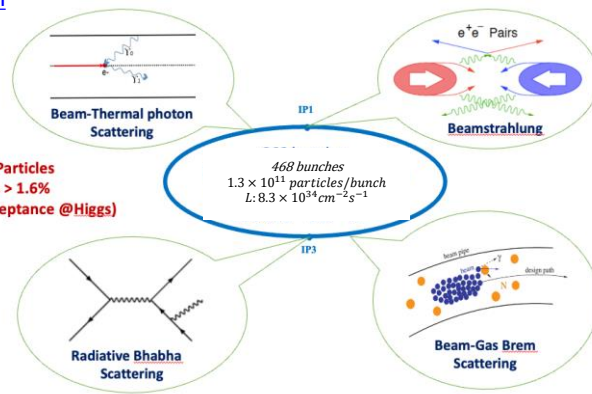

Beam Loss BG

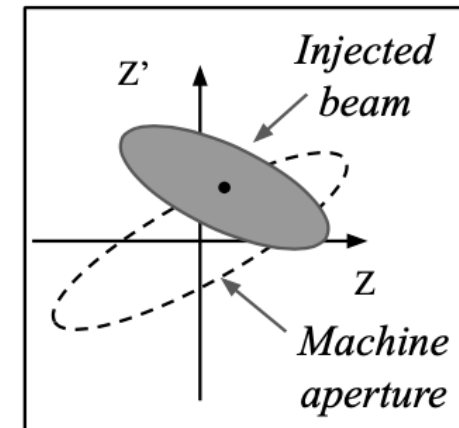

Injection BG

A. Natchii

Background	Generation	Tracking	Detector Simu.
Synchrotron Radiation	BDSim/Ge	BDSim/Geant4	CEPCSW/FLUKA
Beamstrahlung/Pair Production	Guinea-Pig++	SAD	
Beam-Thermal Photon	PyBTH[Ref]		
Beam-Gas Bremsstrahlung	PyBGB[Ref]		
Beam-Gas Coulomb	BGC in SAD		
Radiative Bhabha	BBREM		
Touschek	TSC in SAD		

BG Simulation Status

		Higgs	Z	W	ttbar
Vertex	Noise	Simulated, acceptable	Optimizing	Before Dec 2024	Before Dec 2024
	Radiation	Simulated	Optimizing	Before Dec 2024	Before Dec 2024
Silicon Tracker	Noise	Simulated, acceptable	Optimizing	Before Dec 2024	Before Dec 2024
	Radiation	Simulated	Optimizing	Before Dec 2024	Before Dec 2024
TPC	Noise	Simulated, acceptable	Simulated, acceptable	Before Dec 2024	Before Dec 2024
	Radiation	Simulated	Optimizing	Before Dec 2024	Before Dec 2024
ECal	Noise	Simulated, acceptable	Optimizing	Before Dec 2024	Before Dec 2024
	Radiation	Simulated	Optimizing	Before Dec 2024	Before Dec 2024
HCal	Noise	Simulated, acceptable	Optimizing	Before Dec 2024	Before Dec 2024
	Radiation	Simulated	Optimizing	Before Dec 2024	Before Dec 2024

Benchmark and Validation – Step by Step

- If possible, step by step. If not, using Experimental Data.
 - For Pair-Production, we could have some generation level cross check with FCC-ee's simulation Results

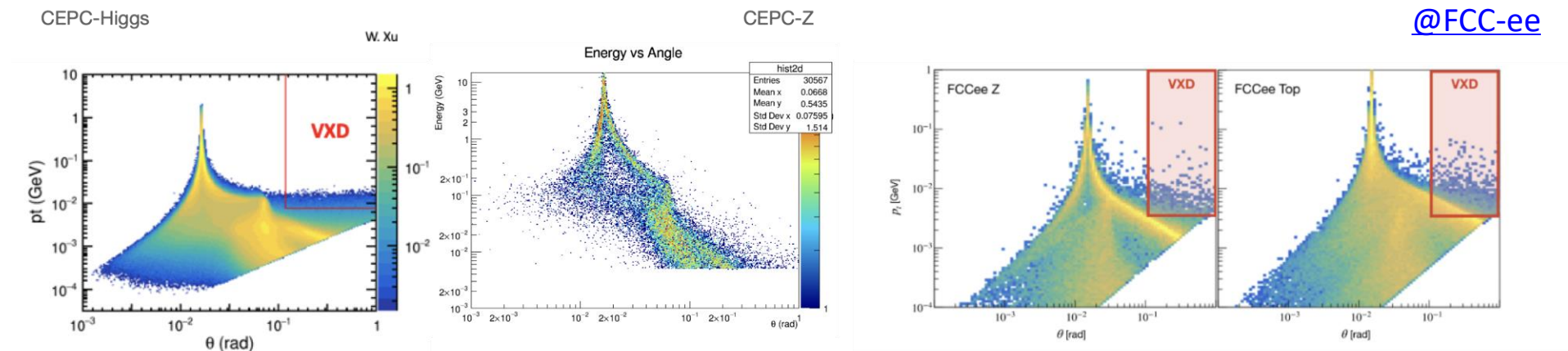

- For Single Beam BG, we have the same generation formula with SuperKEKB

Thoughts on Mitigation Methods

- Based on experience from CDR design and other experiments, we learnt the the mitigation methods are necessary.
- There will be three main methods to mitigate the impacts of the beam induced backgrounds:
 - Try to reduce the loss rate (adjusting lattice, improve vacuum level, etc.)
 - Try to reduce the loss rate at Interaction Region (using collimators/masks)
 - Shielding

Mitigation Methods for Single Beam

- Requirements:
 - Beam stay clear region: $18 \sigma_x + 3\text{mm}$, $22 \sigma_y + 3\text{mm}$
 - Impedance requirement: slope angle of collimator < 0.1
- 16 sets of collimators were implemented for MDI purpose
- ~20 sets of collimators were implemented for Passive Machine Protection but will also benefit for Beam Backgrounds mitigation.
- Needs to add more.

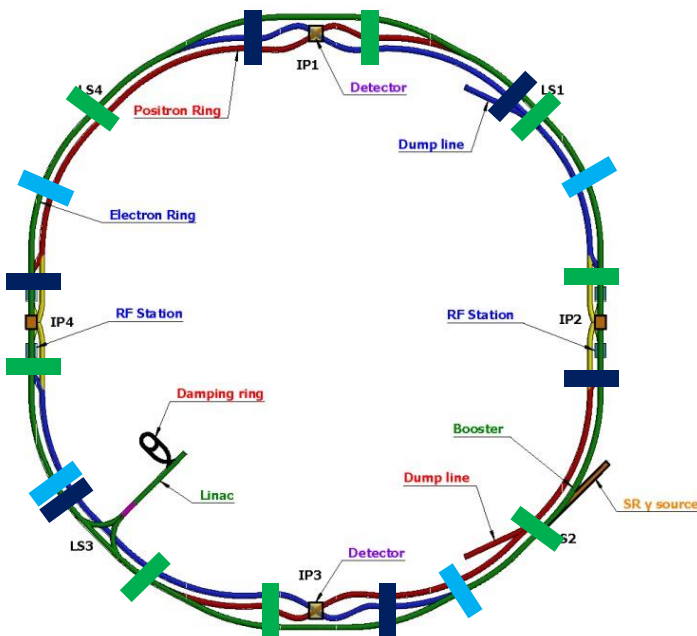
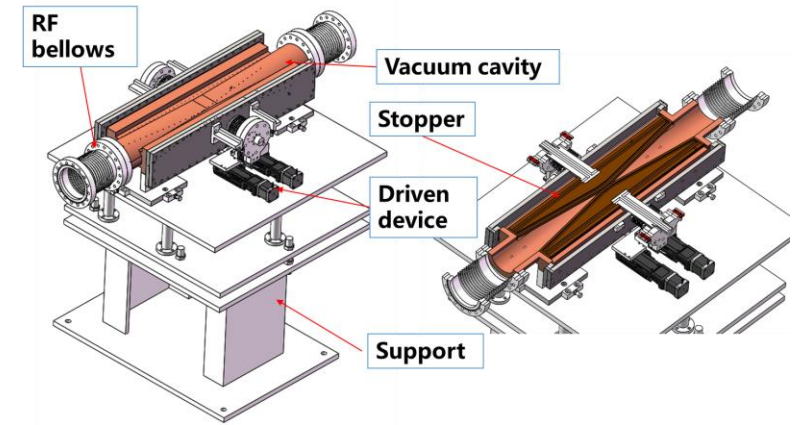

- for H betatron collimator
- for momentum collimator
- for vertical collimator

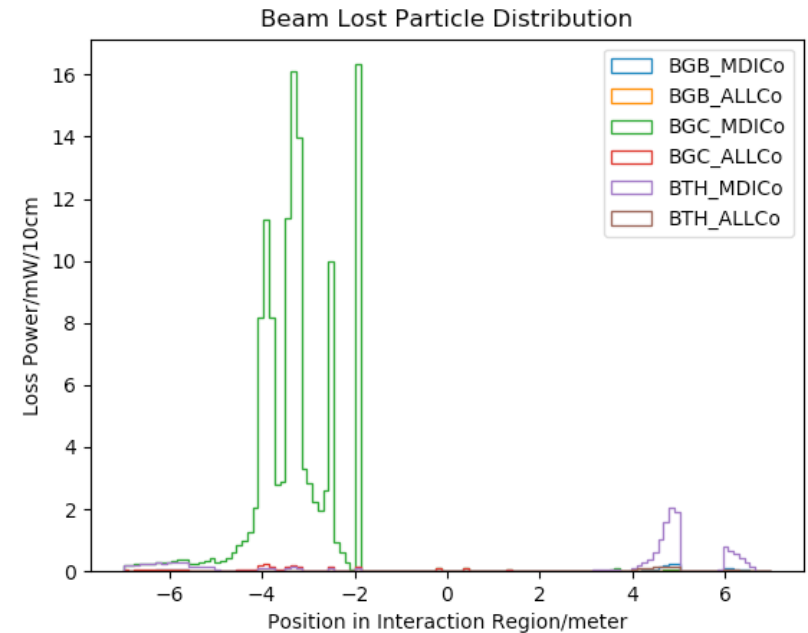

Loss Power of Single Beam @ IR

- Errors implemented
 - High order error for magnets
 - Beam-beam effect
- No Solenoid Currently

$$\text{Loss Rate} = \frac{\text{Loss Number}}{\text{Loss Time}} = \frac{\text{Bunch number} * \text{Particles per Bunch} * (1 - e^{-1})}{\text{Beam Lifetime}}$$

@Higgs

@Z-pole

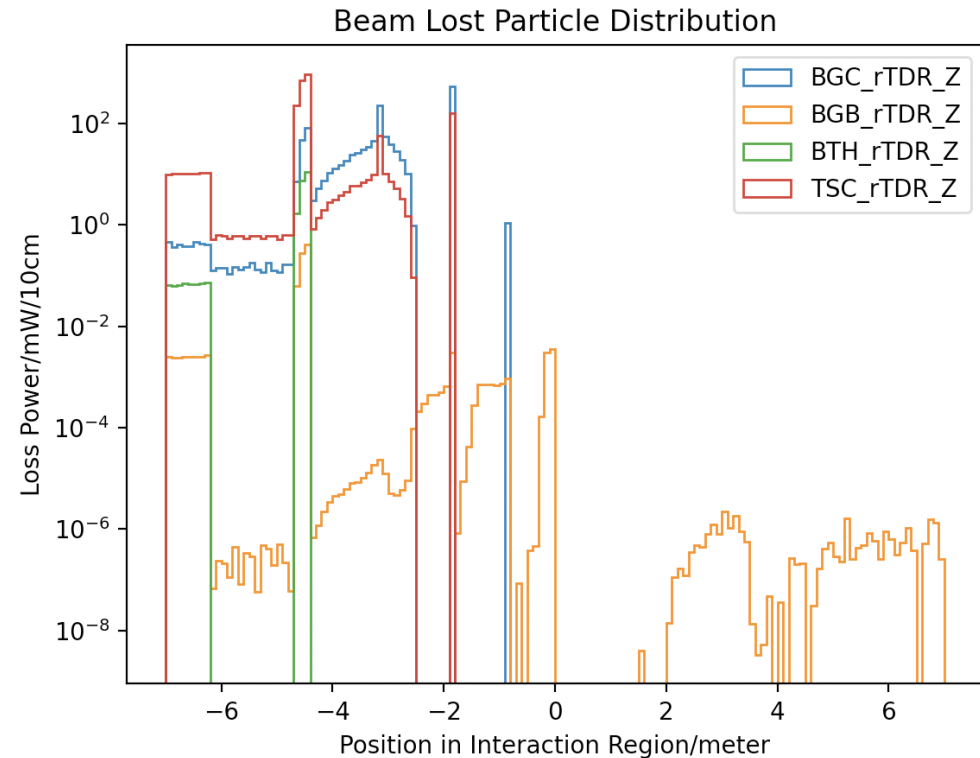
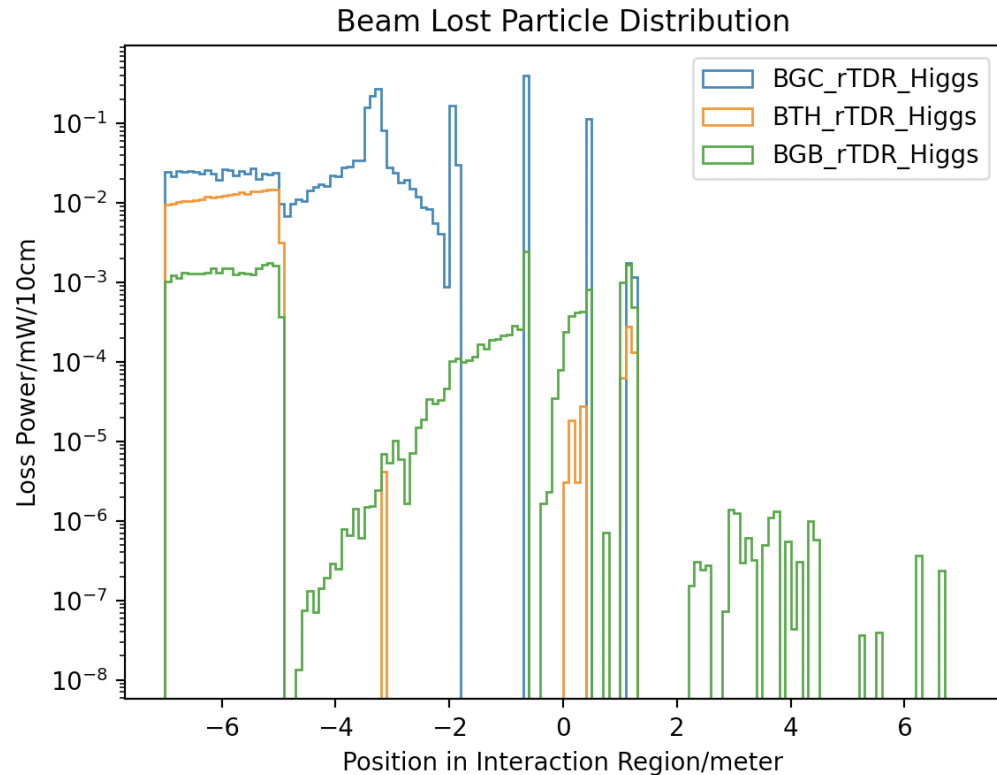

New Beampipe Design – Half Detector pipe

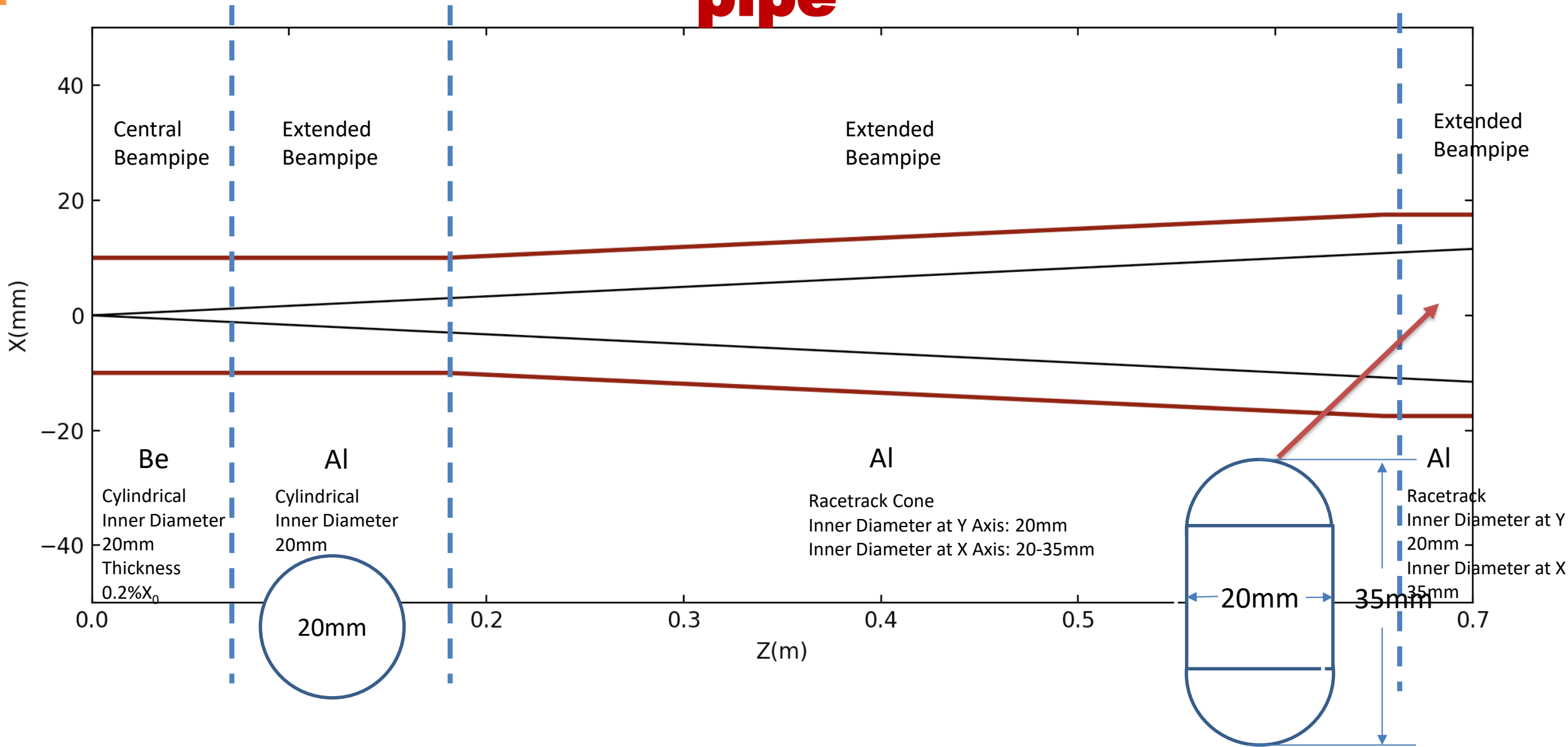

Injection Backgrounds @ Higgs

- A preliminary study on the injection backgrounds has been performed:

S. Bai

- RBB is taken into account in all cases
- A simplified model of top-up injection beam
- Tails from imperfectly corrected X-Y coupling after the injection point
- Some tolerances to imperfect beams from the booster (e.g. too large emittances)
- non-Gaussian distributions existing/building up in the booster and being injected into the main

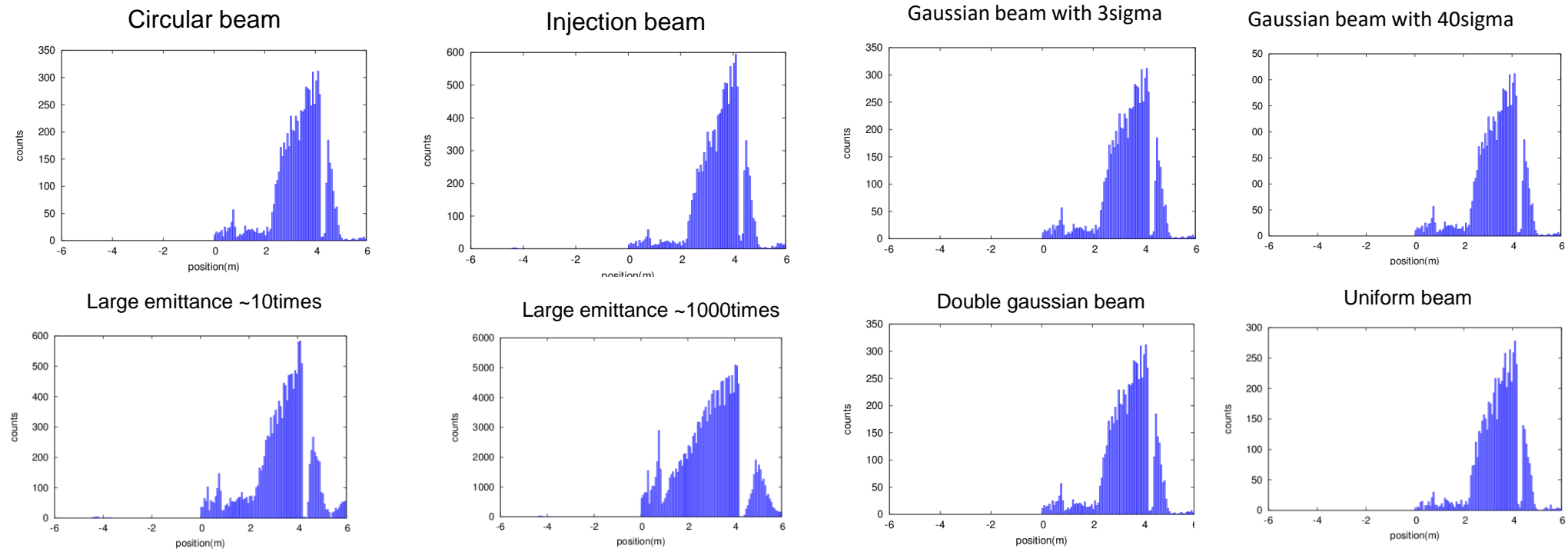

Key aspects of the MDI design(Both Acc. And Det.)

- **Beam induced backgrounds**
 - The MDI region is now improved as more realistic, and software model developed. Narrow the difference with future experiments.
 - Backgrounds, collimators, IR beam losses, SR, IR radiation level & fluences
 - Beamstrahlung dumps with radiation levels.
- **Heat loads in IR region**
 - HOM heating, SR, Beam loss backgrounds, Beam pipe thermal analysis
- **IR magnet system & Cryostats**
 - FF Quads & Correctors
 - Solenoid compensation & anti-solenoid design update
 - Cryomodule design update, thermal and mechanical analysis of the structure, optimization of heat and mass transfer of the helium, design of current leads. PI&D scheme determination, assembly process design and alignment considerations.
- **IR Mechanical model, including vertex and lumical integration, and assembly concept**
 - Cooling for vertex and vacuum chambers
 - Remote Vacuum connection, IR BPMs
 - Integrate in the design an alignment system
 - Overall integration and installation for all components in the MDI. Specific installation procedure.

MDI Work Map

Accelerator

IP Feedback

BG Simulation

Lumi Monitor

HOM absorber

Vacuum Chamber

SR Masks

QDa/QDb/QF1

Anti-Solenoid

Cryostats

BPMs

Instability&Impedance

Cooling

Shielding

Assembly&Supporting

Alignment

Connecting System

Vacuum pumps

Last Bending Magnet

Collimators

Control

Central Beam Pipe

Vertex Detector

LumiCal

Silicon Tracker

TPC

Hcal

Ecal

Solenoid

Yoke

Muon Detector

Hall

BG Simulation&Shielding

Software Geometry

Alignment&Assembly

Electronics

Cryogenic

Radiation Protection

Booster

Detector