

BESIII探测器及其升级

董明义



中国科学院高能物理研究所

2024.12.29

Outline

- Introduction of BEPCII and BESIII
- Sub detectors of BESIII
- Upgrade of EFOF and inner drift chamber

北京正负电子对撞机 (BEPCII)

- BEPCII是一个高亮度、多束团的双环对撞机，2~5GeV, τ -粲物理研究由BEPC升级而来，在原有隧道内新建一个储存环，采用多束团、大交叉角对撞方式，亮度提高2个数量级，达到 $1 \times 10^{33} \text{ cm}^{-2} \text{ s}^{-1} @ E_{\text{cm}} = 3.78 \text{ GeV}$ 。
- BEPCII 包括直线部分和储存环部分。LINAC(200米)，用于产生高能正负电子，储存环(周长为240.4米)，用于高能正负电子存储、对撞等

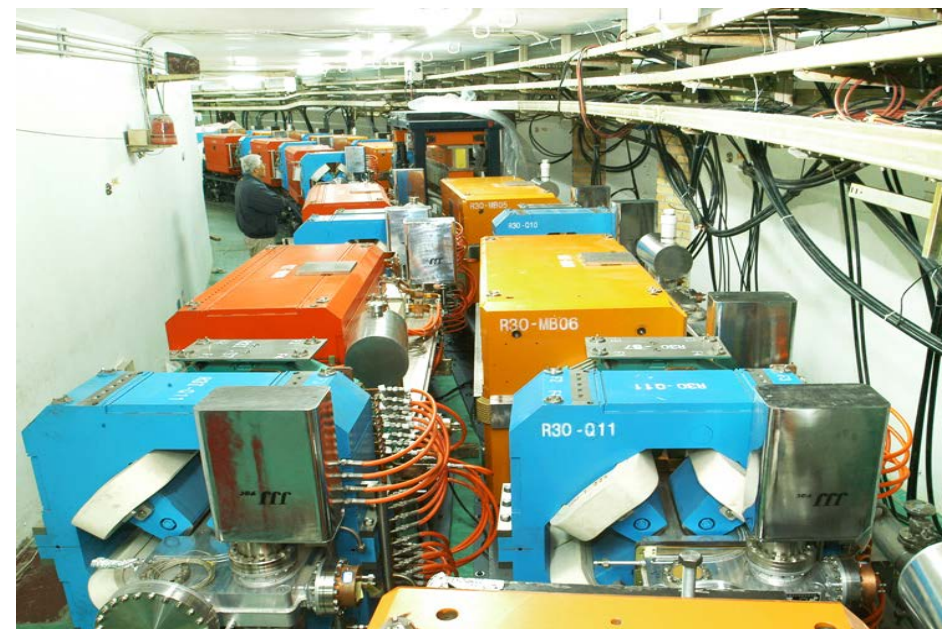
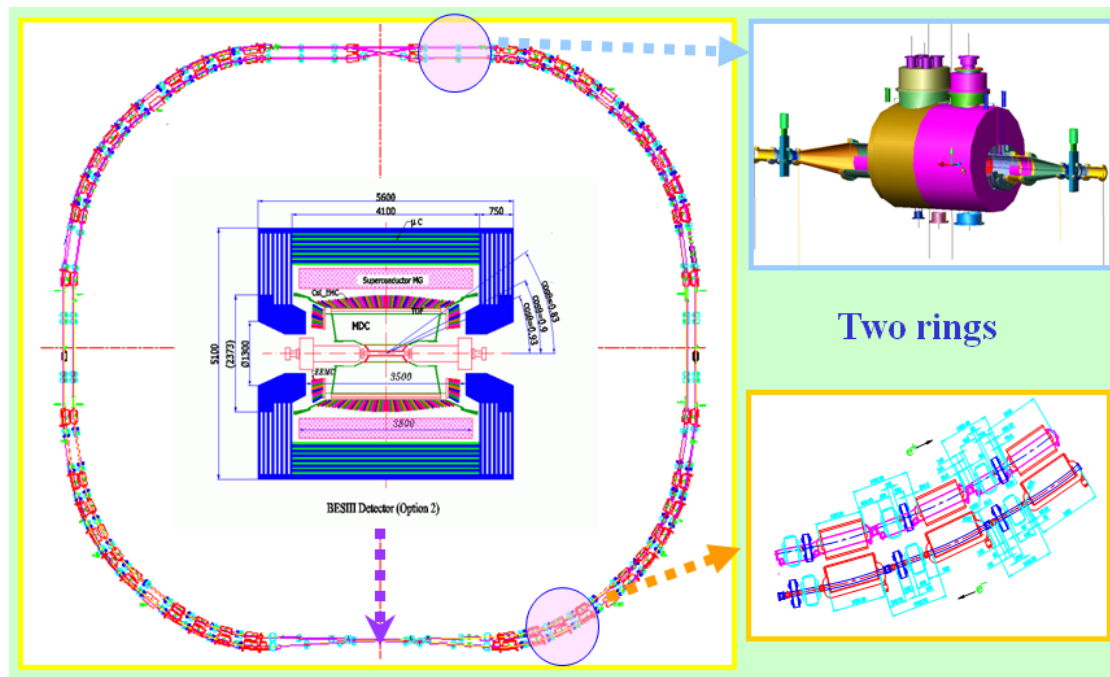

北京谱仪 (BESIII)

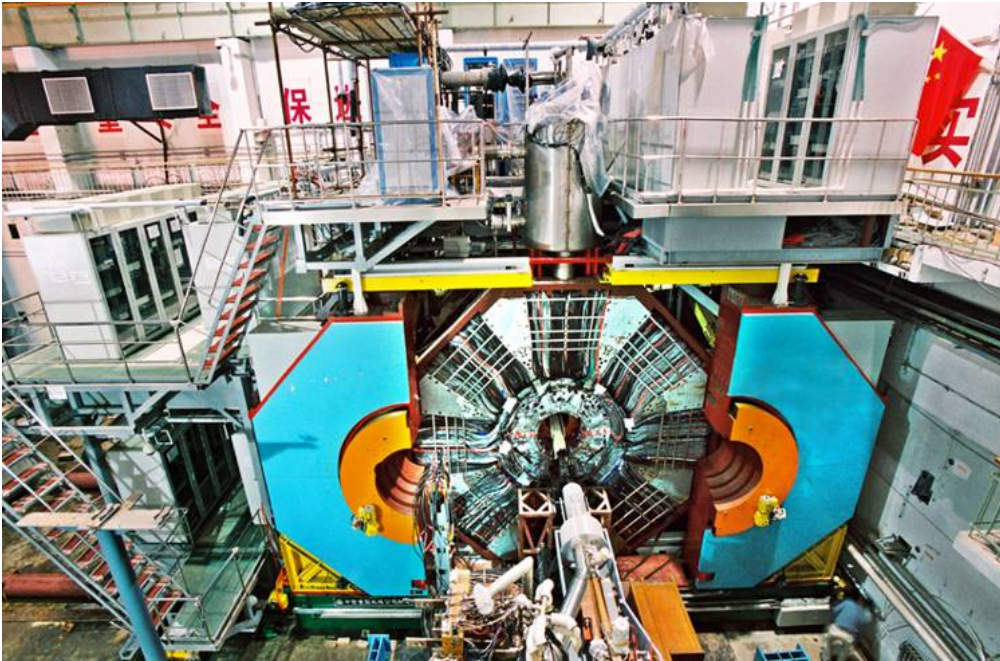

- 四个子探测器: MDC, TOF, EMC, MUC
- SSM: Solenoid Superconducting Magnet
- Trigger system
- DAQ system
- Slow control system
-

- Beijing Spectrometer(BESIII) is a general purpose detector at Beijing Electron-positron Collider (BEPCII)
- Versatile researches in τ -charm physics

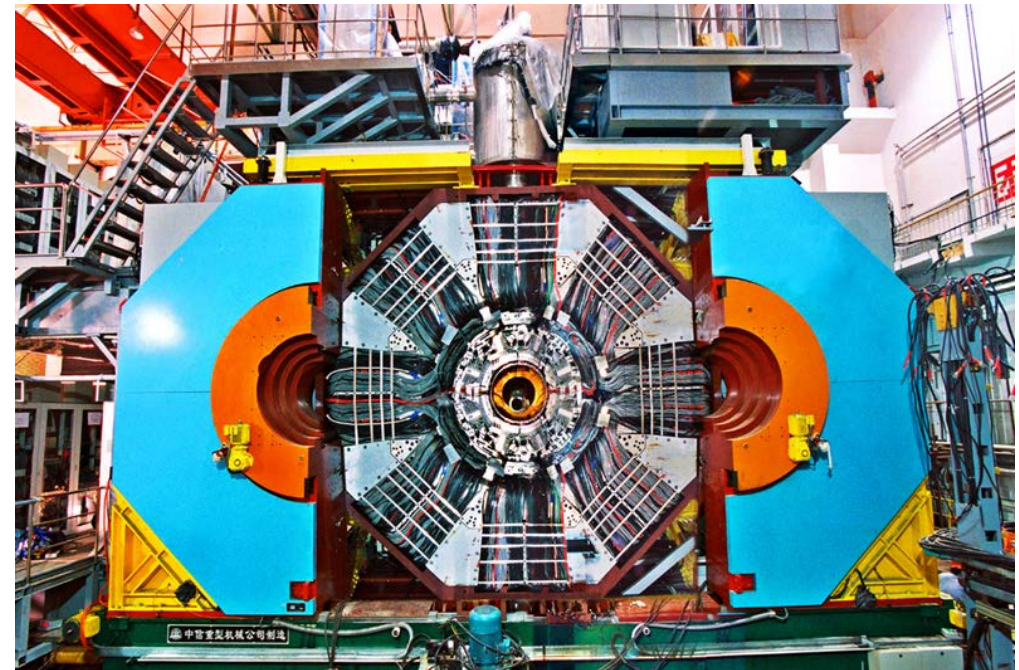

BESIII collaboration

- 成立于2006.10
- 目前：
 - >600 members
 - 85 institutes
 - 16 countries and regions



积分亮度

- 总积分亮度: 52.6 fb^{-1}
 - 10B J/ψ events
 - 2.7B $\psi(2S)$ events
 - $20 \text{ fb}^{-1} \psi(3770)$
 - $3.2 \text{ fb}^{-1} D_s$
 - $21.9 \text{ fb}^{-1} E_{\text{cm}} > 4\text{GeV}$ data
 -
- Most of them are the largest events in the world

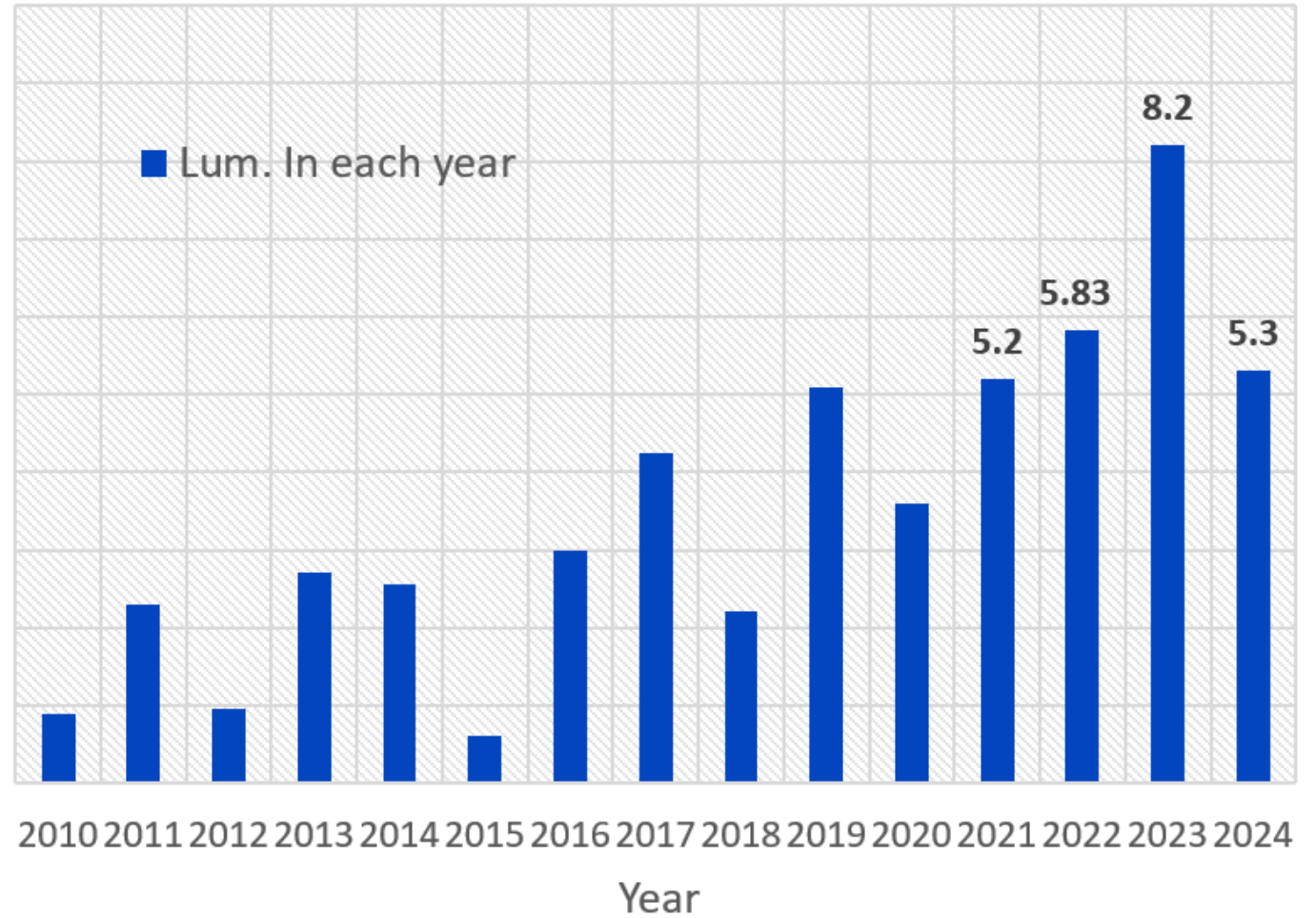

The BESIII experiment

- Started commissioning run in July, 2008
- Started data collection in 2009
- **More than 16 years operation**
- BEPC and inner tracker of BESIII were upgraded this year
- BESIII will continue to operate until 2030

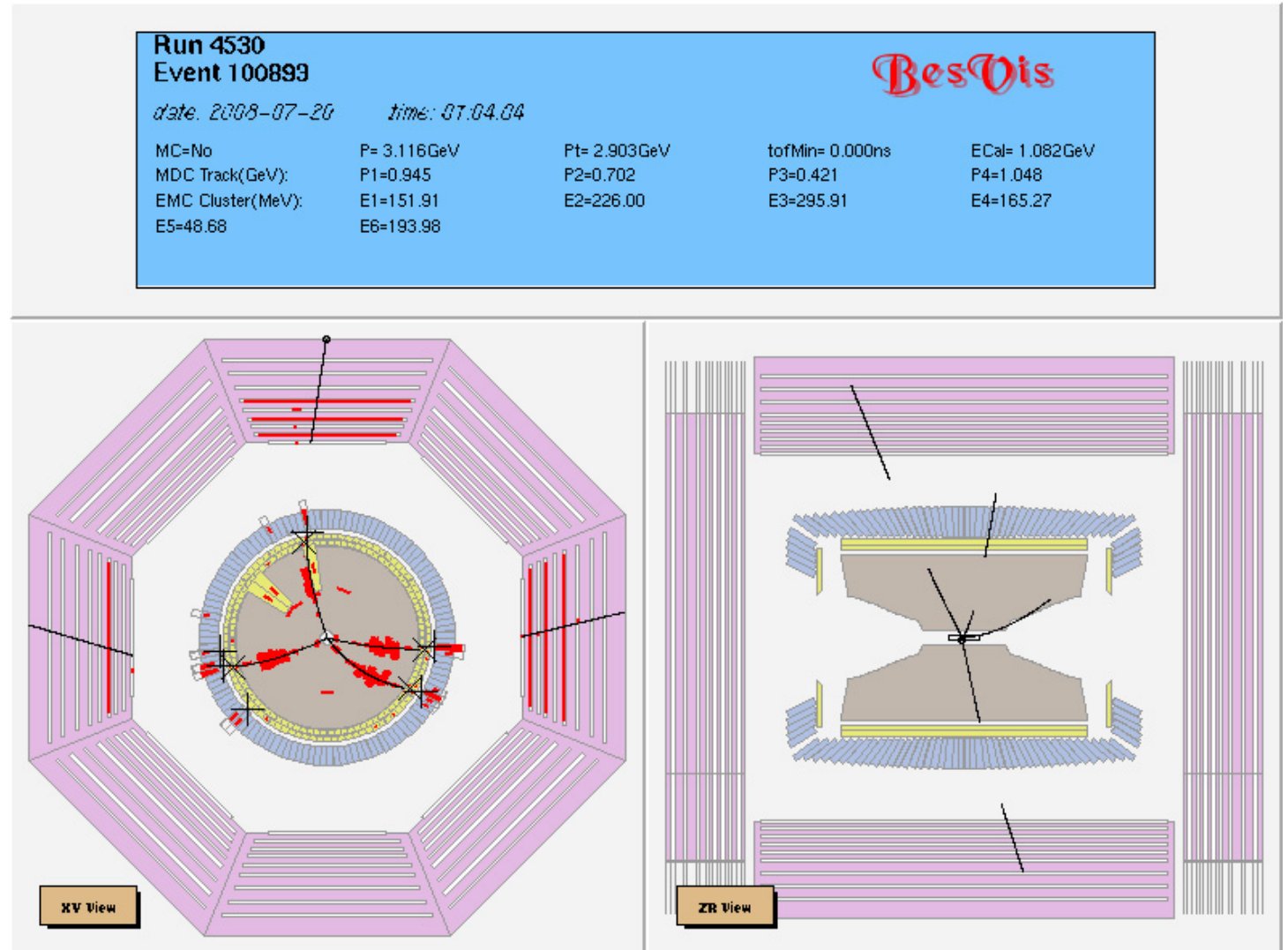

Design and construction of BESIII

与BEPCII的高事例率相匹配，满足精确测量的要求，BESIII必须是高精度的探测器

- a) 单丝分辨率好于 $130\mu\text{m}$ 的He基气体漂移室
- b) 能量分辨率好于 2.5% @ 1GeV 的CsI晶体电磁量能器
- c) 时间分辨好于 100ps 的TOF
- d) 磁场强度为 1Tesla 的超导螺旋管磁铁
- e) 基于RPC的 μ 子探测器

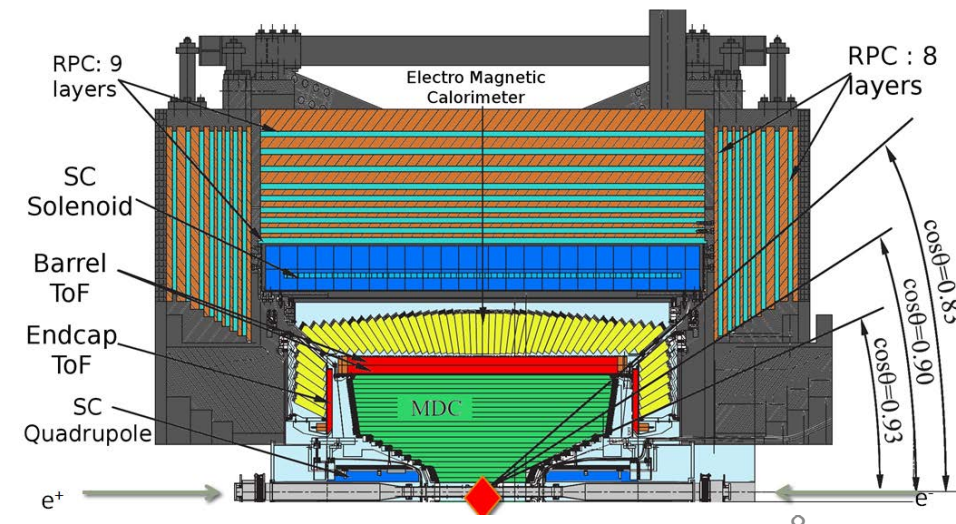
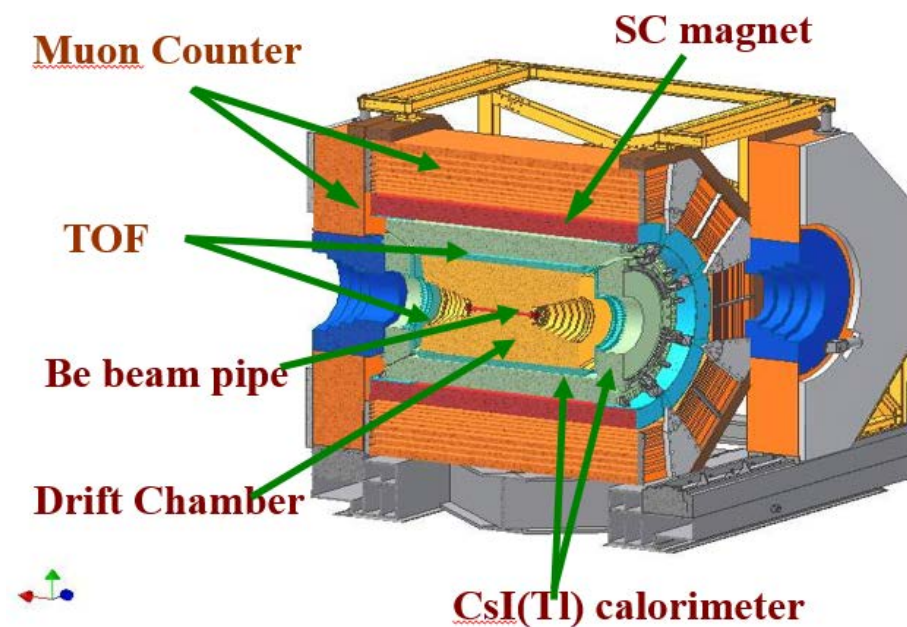

Drifter chamber (MDC)

- Main tracking detector for the charged particles
Position, momentum and dE/dx measurements
- Consists of inner chamber and outer chamber
- 43 layers in total
8 layers (Inner chamber)+35 layers(Outer chamber)
19 axial layers, 24 stereo layers, 6796 cells in total

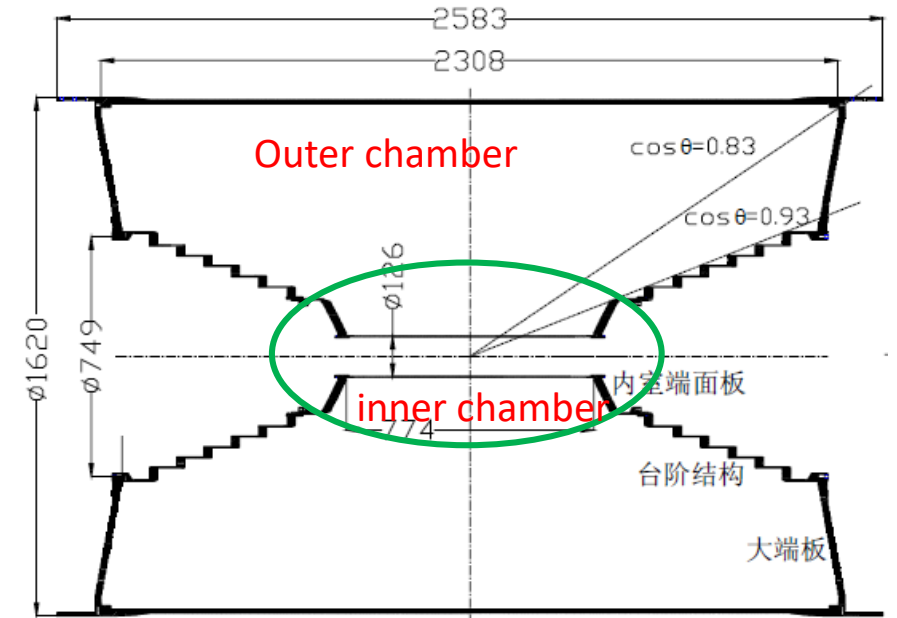
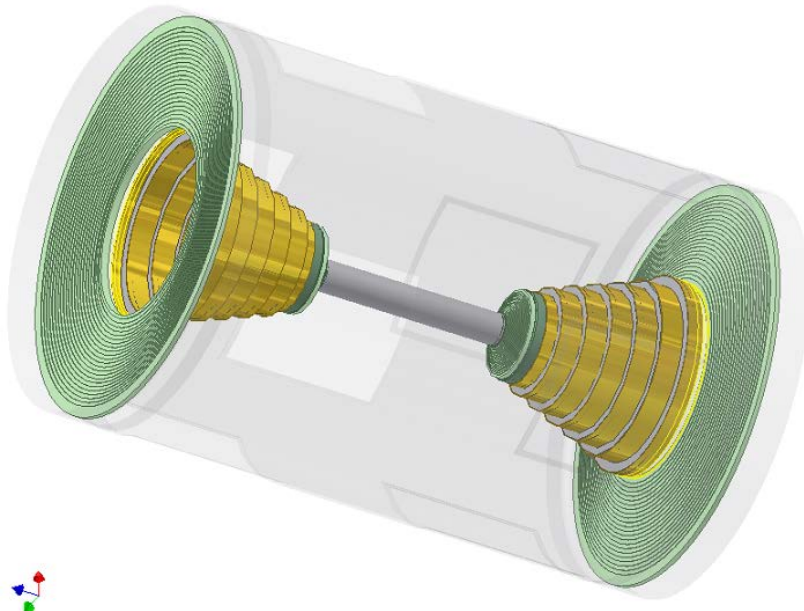

- Radius extension : 63 mm \rightarrow 810 mm
- Length: 2308 mm
- Inner cylinder: 1.2mm carbon fiber
- Outer cylinder: 11.5 mm CF with 8 windows
- End plates: 18 mm Al (6 stepped and inner end plates : 25 mm Al)

小单元设计和氦基工作气体

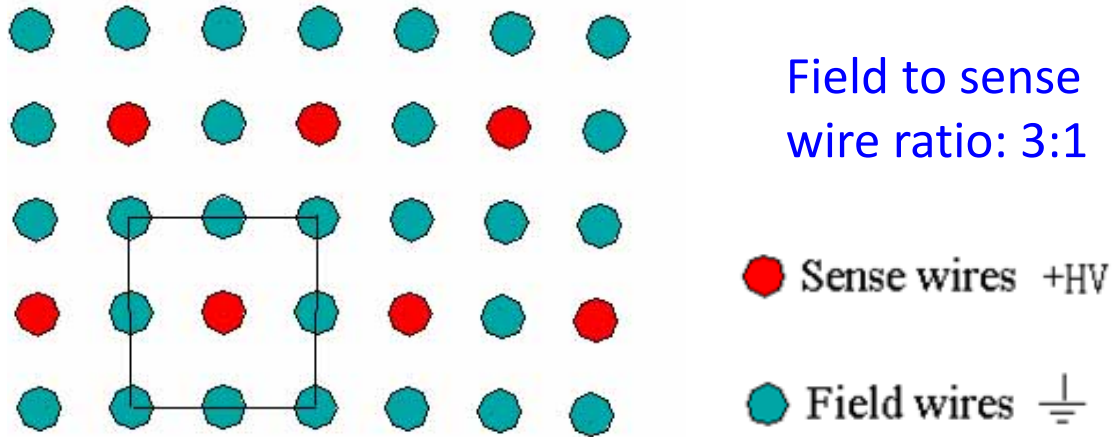

- cell size:

inner chamber: 12mm × 12mm

outer chamber: 16.2mm × 16.2mm

- Sense wires: $\phi 25\mu\text{m}$ W (Au)
- field wires: $\phi 110\mu\text{m}$ Al (Au)
- 28680 wires in total

Attractive features of small cells

- Small drift distance → fast trigger
- Can reduce electron diffusion → improve spatial resolution
- Can put more layers in limited space → improve $\sigma_{dE/dx}$
- Reduce accumulated charge of the cells → slow down aging

- He based gas mixture

- He : C₃H₈ = 60% : 40%

- low material budget to reduce multiple scattering, X_0 : 500 m, $v_e=3.8$ cm/ μs



Construction of MDC

- Main R&D:
 - Materials: wire(tension, creeping, ...), glue(aging, radiation hardness), feedthrough(precision, HV resistance), ...
 - Prototyping & test beam
- Manufacturing and assembly:
 - Precision of end-plates: very difficult, failed twice
 - Feedthrough: precision, ...
 - Wiring, carbon fiber cylinders, precision of assembly, gas tightness, ...

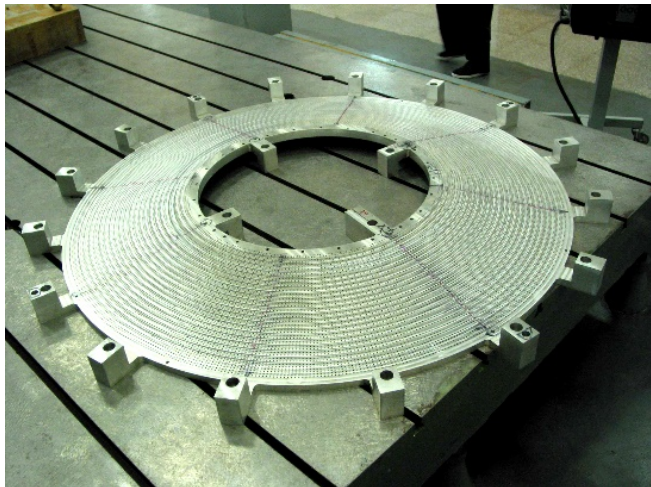
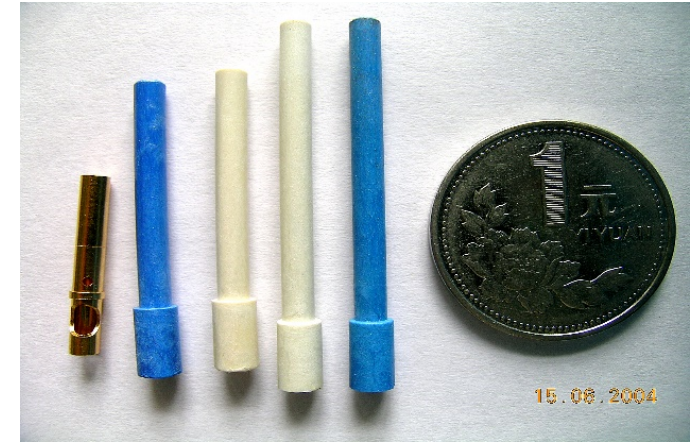

飞行时间探测器 (TOF)

- 测量粒子飞行时间，用于粒子鉴别
- 包括桶部和两个端盖探测器
- 桶部
 - 双层设计，2 层 88×2 个 BC408 闪烁体
 - 尺寸: $50\text{mm} \times 60\text{mm} \times 2320\text{mm}$ (inner layer)
- 端盖
 - 每个端盖48个扇形BC404闪烁体
- PMT: Hamamatsu R5942

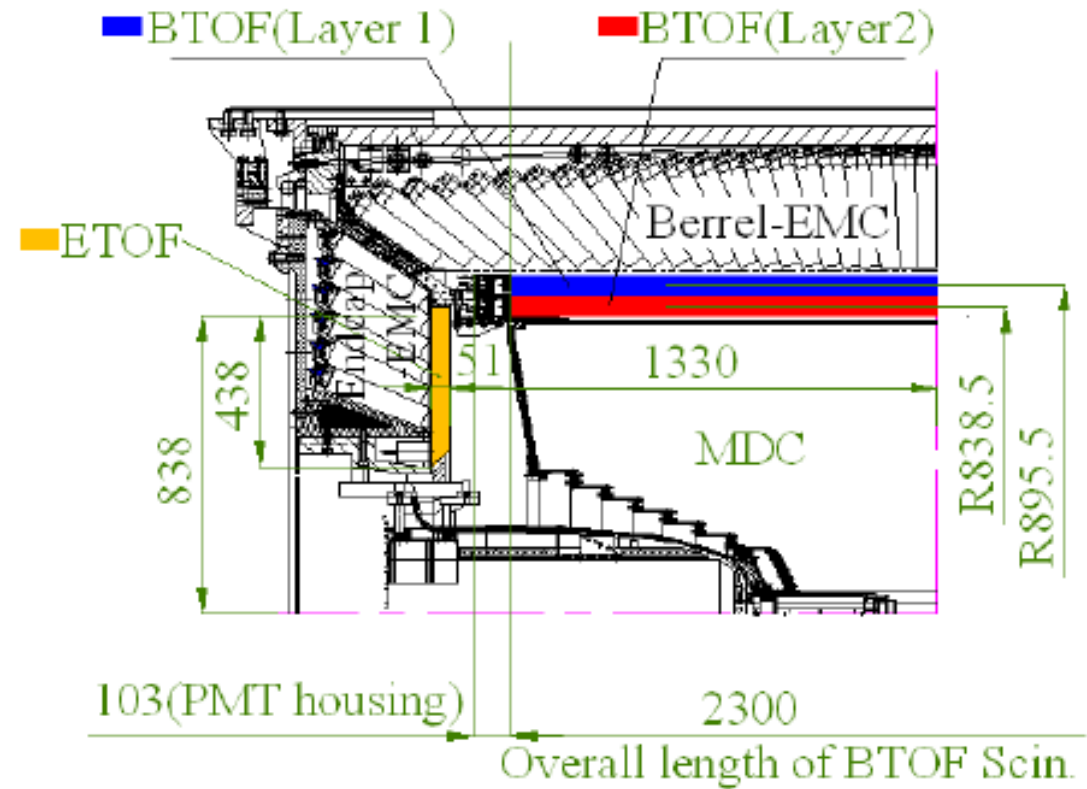
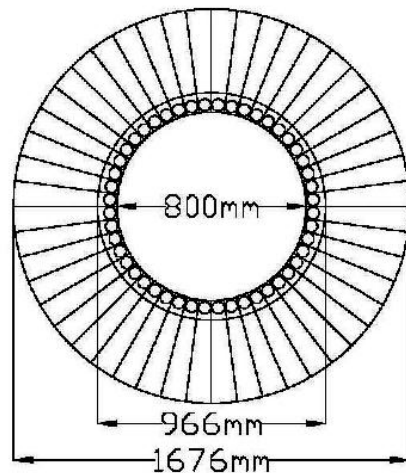
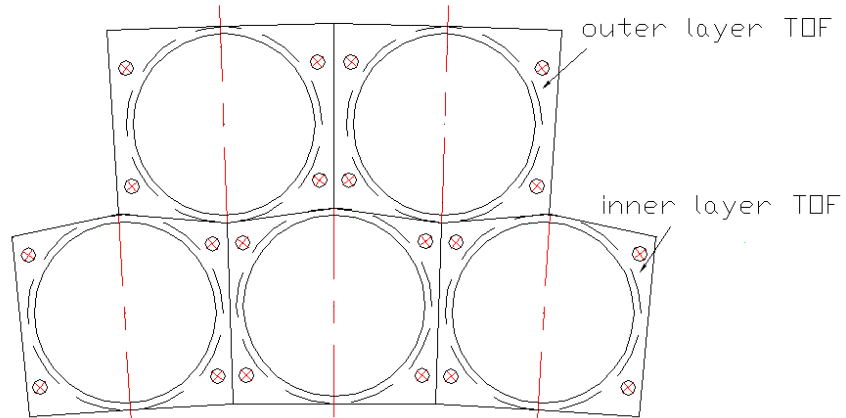

Construction of TOF

- Module study and production : radiation hardness, wrapping, optical coupling, effects of magnetic field, test beam, ...

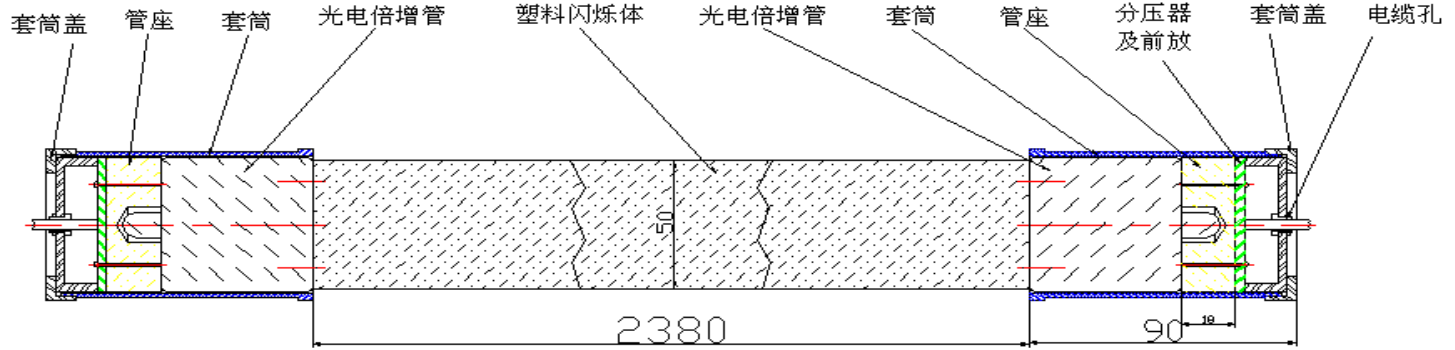

Capability of separation of Kaon and Pion

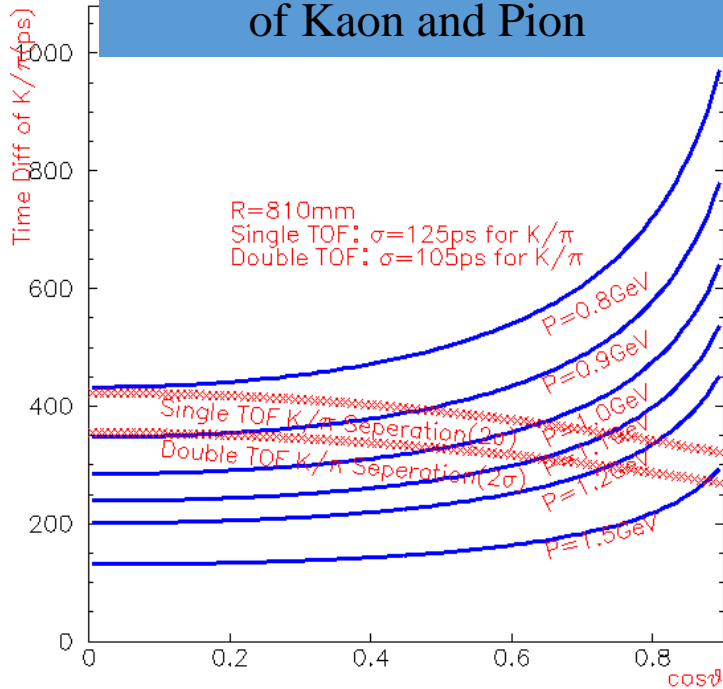

电磁量能器 (EMC)

- 精确测量 γ 和电子的能量和位置
- 全吸收型电磁量能器：包括桶部和两个端盖
- CsI(Tl) crystal, 耦合PD(Hamamatsu S2744-08)读出
- 晶体单元：5280 (桶部)+ 960 (端盖)，共 6240 晶体单元

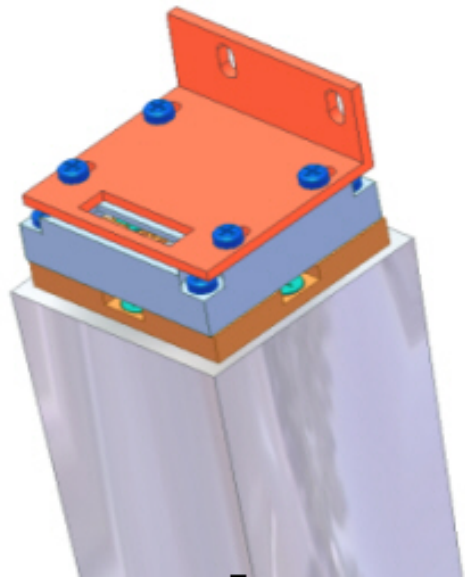
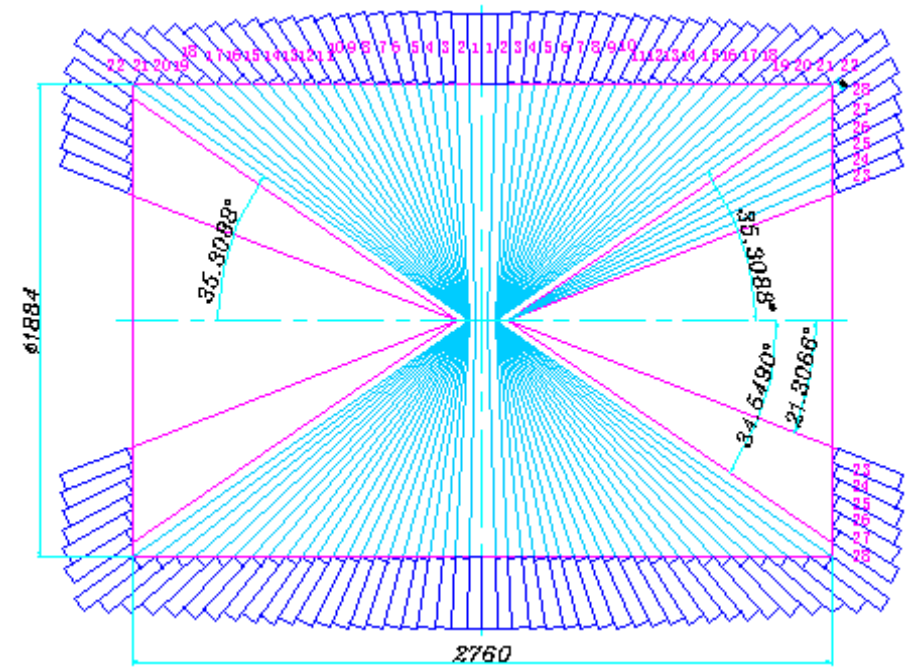

CsI(Tl)晶体探测单元

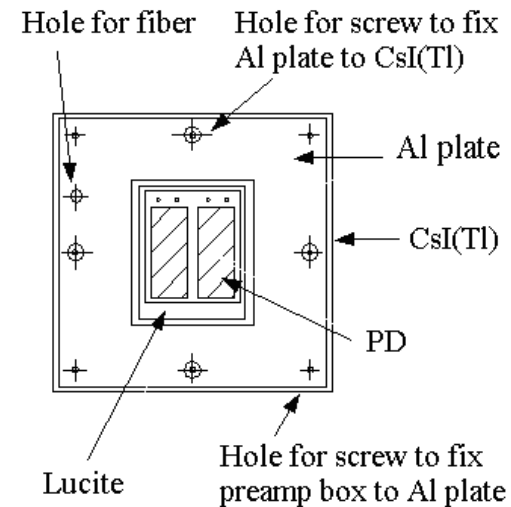
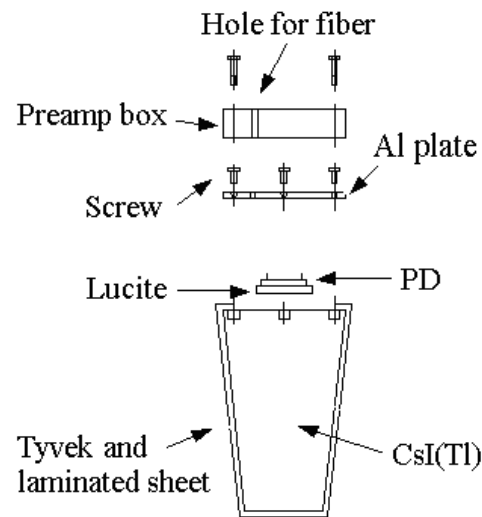

Construction of EMC

- Crystal module study and production: light yield, uniformity, wrapping, PD, test beam,...
- CsI(Tl) crystals produced from SIC, Hamamatsu and Saint-Gobain in order to control the risk, cost and quality
- Low noise electronics: 1000 e equivalent \sim 220 keV
- Using screws instead of honeycomb structure to hold crystals

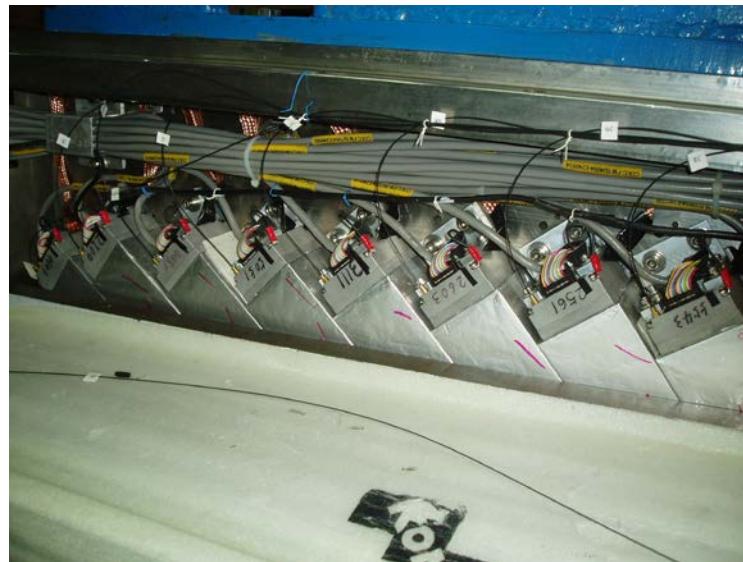

Superconducting Magnet

- 提供1T轴向磁场
- Key Issues: structure, cable winding, assembly, valve box...
- Huge risk: not possible to test before the final curing
 - too late if we know it is not good
- After 3 times of quenching, the magnet reached 1T
- Field mapping: $\Delta r < 0.5 \text{ mm}$, $\Delta B < 0.1\%$

- 迄今为止，国内最大的单磁体超导磁铁

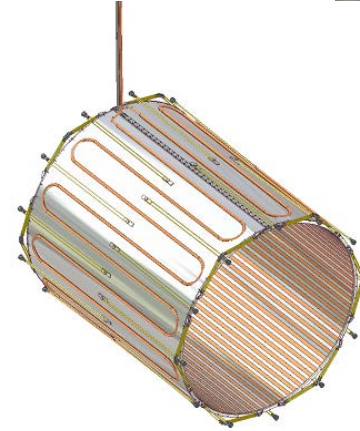

Muon detector (MUC)

- μ 探测器位于BESIII探测器的最外层，测量反应末态中的 μ 子的位置和大致飞行轨迹
- 包括桶部 (9 layers)和 2 个端盖 (8 layers)，由 μ 探测器和强子吸收体组成
- 基于阻性板 (RPC) 探测器，约2000 m² RPC
- 4cm 宽读出条，约9000 channels

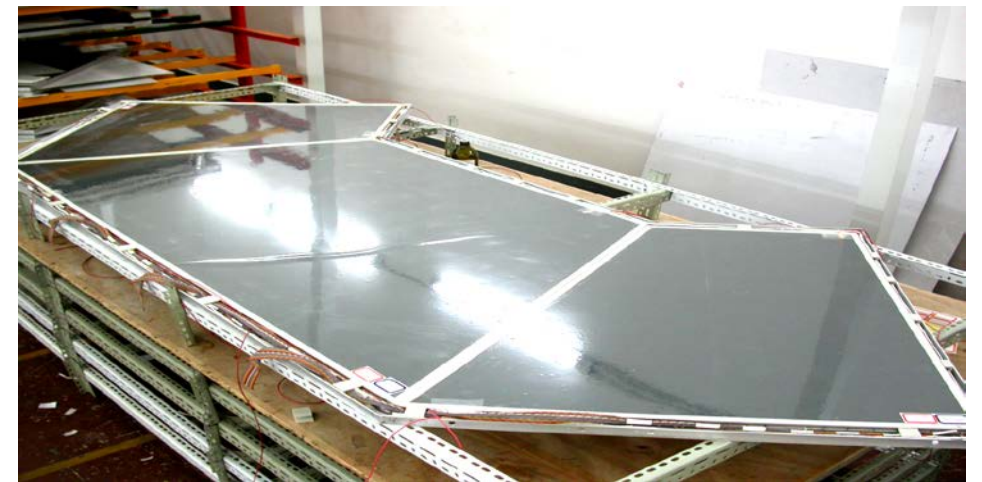
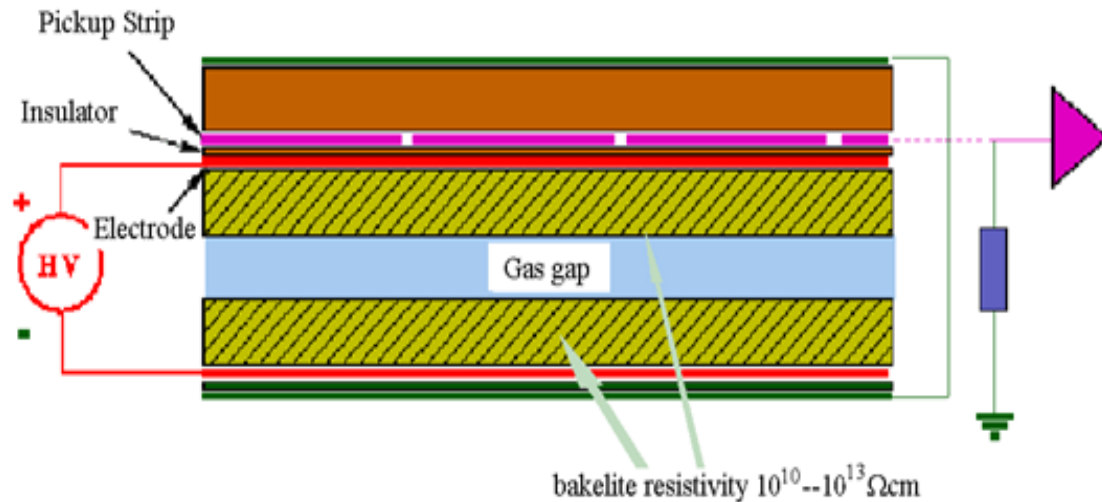
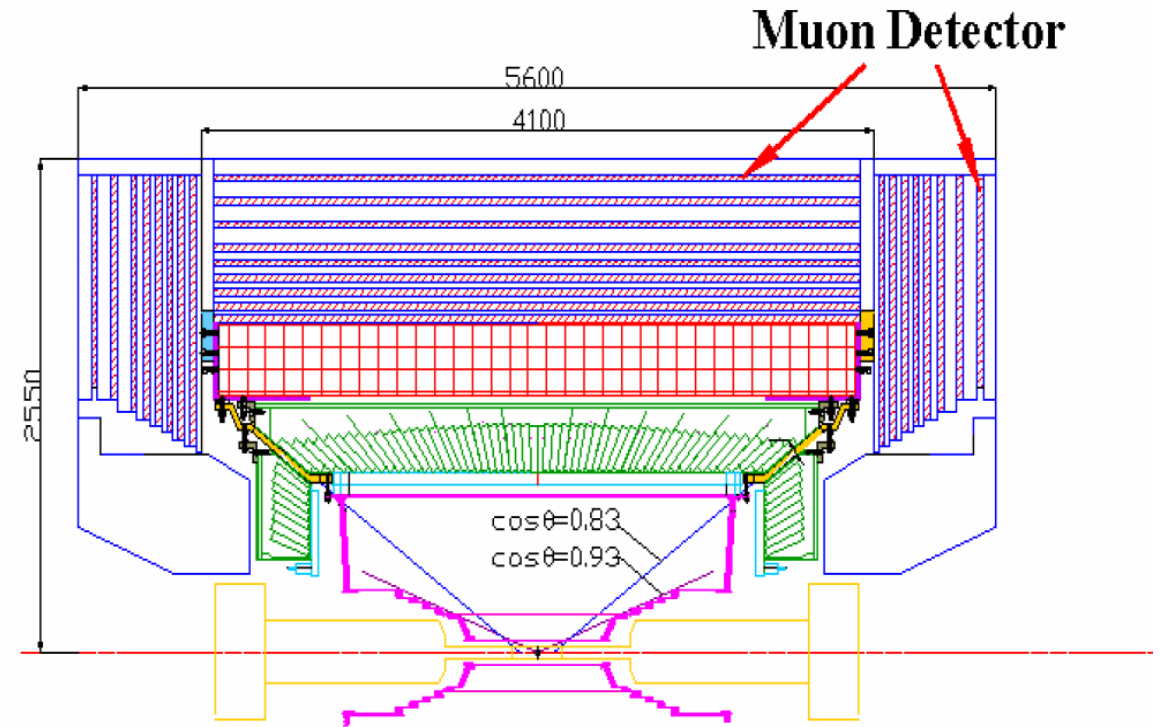

Construction of RPC muon chamber

- 电极用特殊的石碳酸纸贴在酚醛塑料板上做成，用 $50\mu\text{m}$ 的膜代替亚麻油
- 国际首创的无油阻性板RPC技术，解决了寿命问题
- 噪声小于 0.05 Hz/cm^2
- RPC探测效率高，噪声计数率和暗电流低，长时间工作稳定性好

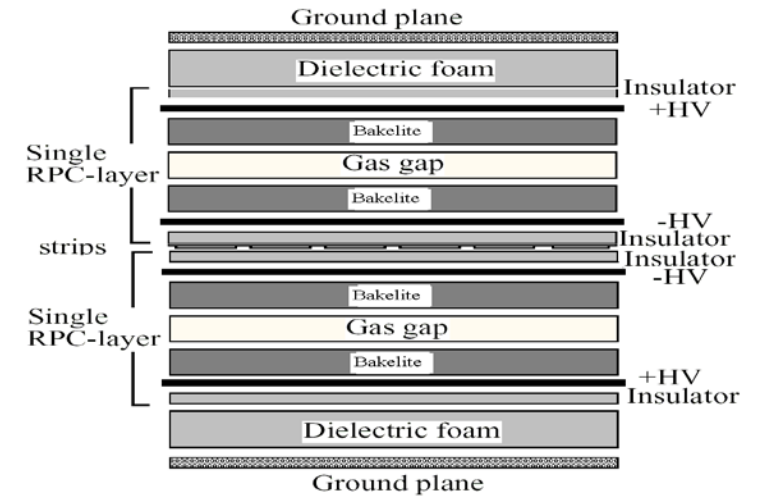

RPC surface seen by the atomic force microscope

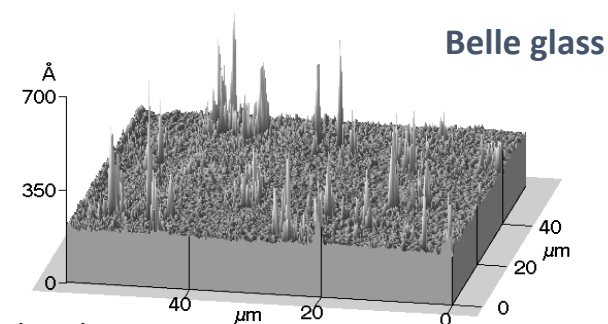
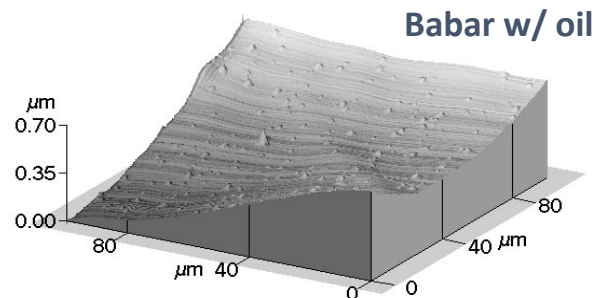
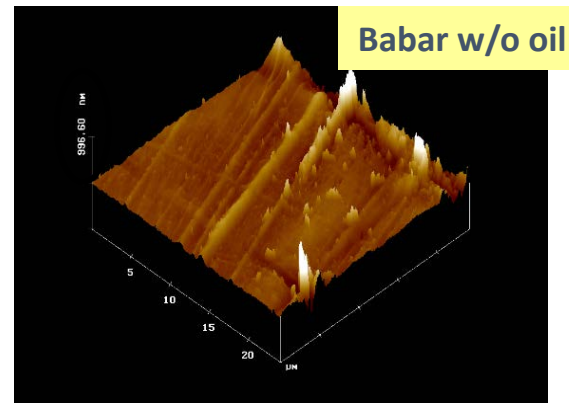
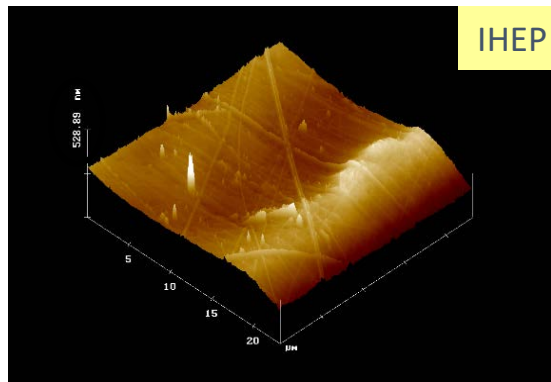

C. Lu, Princeton University



Other systems

- Beam pipe
- Electronics, Slow Control and Grounding
- Trigger system
- DAQ system
- Software and data flow
-

BESIII performance

Sub detector		Design Performance	Achieved Performance
MDC		$\sigma_{r\phi} = 130\mu m$ $\Delta p/p = 0.5\% @ 1 GeV$ (B=1T) $\sigma_{dE/dx} = 6\%$	$\sigma_{r\phi} = 115\mu m$ $\Delta p/p = 0.5\% @ 1 GeV$ (B=1T) $\sigma_{dE/dx} = 6\%$
TOF	Barrel	$\sigma_T = 80 \sim 90 ps$	$\sigma_T = 68 ps$
	Endcap	$\sigma_T = 110 \sim 120 ps$ (before upgrade) $80 ps \sim 100 ps$ (after upgrade)	$\sigma_T = 110 ps$ (before upgrade) $60 ps$ (after upgrade)
EMC		$\Delta E/E = 2.5\% @ 1 GeV$ $\sigma = 6 mm/\sqrt{E}$	$\Delta E/E = 2.5\% @ 1 GeV$ $\sigma = 6 mm/\sqrt{E}$
MUC		$\sigma_{r\phi} = 14 mm \sim 17 mm$ $\sigma_z \sim 17 mm$	$\sigma_{r\phi} = 14 mm \sim 15 mm$ $\sigma_z \sim 17 mm$

BESIII 各子探测器性能均达到或超过设计指标，通过国家验收

Comparison between BESIII, BESII, CLEOc and Belle

system	BES III	BES II	CLEOc	Belle
MDC	$\sigma_{XY} = 115\mu\text{m}$	250 μm	130 μm	130 μm
	$\Delta P/P (\%) = 0.5 \%(1 \text{ GeV})$	2.4 $\%(1 \text{ GeV})$	0.5 $\%(1 \text{ GeV})$	0.5 $\%(1 \text{ GeV})$
	$\sigma_{dE/dx} (\%) = 6\%$	9%	6%	7%
EMC	$\Delta E/\sqrt{E}(\%) = 2.5 \%(1 \text{ GeV})$ $\Delta\theta=5 \text{ mrad}(1 \text{ GeV})$	20 $\%(1 \text{ GeV})$ $\Delta\theta=25 \text{ mrad}(1 \text{ GeV})$	2.3 $\%(1 \text{ GeV})$ $\Delta\theta=5 \text{ mrad}(1 \text{ GeV})$	2.2 $\%(1 \text{ GeV})$ $\Delta\theta=5 \text{ mrad}(1 \text{ GeV})$
TOF	$\sigma_T (\text{ps}) = 68 \text{ ps Barrel}$ 110 ps endcap 60 ps new MRPC endcap(2015)	180 ps Barrel 350 ps endcap	139 ps	90-100ps
μ counter	9 / 8 layers	3 layers	3 layers	14 layers
Magnet	1.0 tesla	0.4 tesla	1.0 tesla	1.5 tesla

Stable operation for 16 years

- MDC :
 - No broken wire. 43 dead channels in total, 40 channels can be repaired due to preamp issues
 - Hit efficiency: 90%~97%, except for the first 3 layers
- EMC:
 - No dead crystal module. 27 unglued modules, light yield of 5 modules dropped to about 60-70%
 - Efficiency : Almost 100%, except for the 5 unglued modules
- BTOF:
 - No dead channel
 - Efficiency : 95%~97% for single end
- ETOF:
 - 6 dead channels can be repaired due to preamp issues
 - Efficiency : 98.5%, except for the dead channels
- MUC:
 - 1 module dead (east endcap layer0)
 - Efficiency : >90%

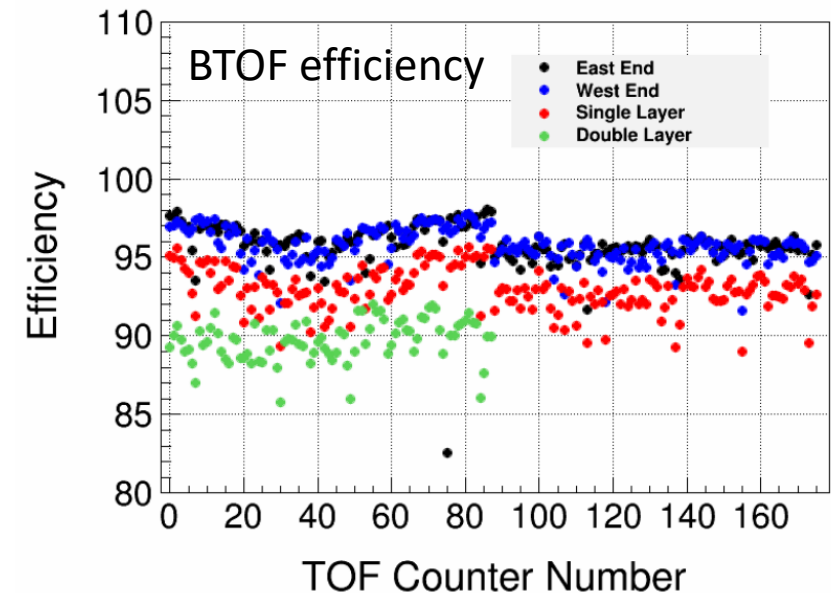
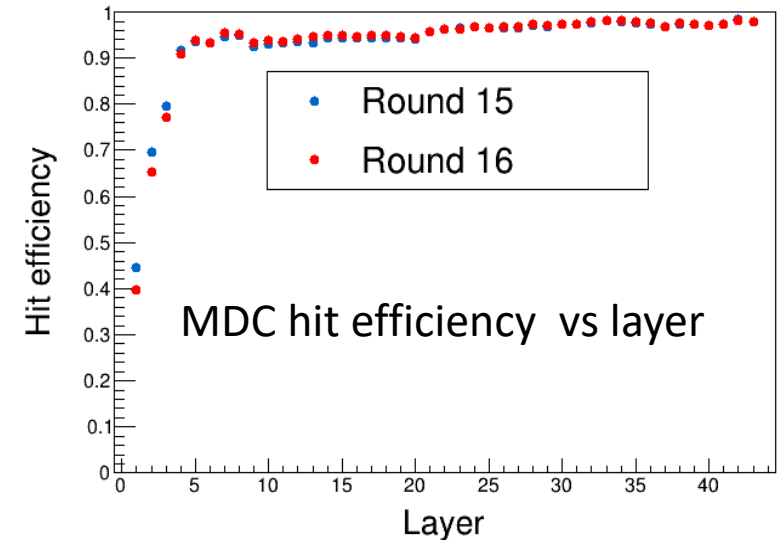

BESIII探测器的升级

- 端盖TOF升级
- 漂移室内室升级

端盖TOF升级

相比于桶部TOF，端盖TOF时间分辨较大(110ps)

1. 物质层散射——>端盖径迹长度不确定性增加；
2. MDC较少丝层可用于小角度的径迹重建——>Z向击中位置不确定性，~90ps/cm
3. Multi-hit: 75%
4. 端盖TOF受到噪声问题的困扰；

经过预研，采用**MRPC**探测器进行端盖**TOF**的升级

主要方案

- 探测器：MRPC
- 探测器读出：
 - Small Pad 且双端读出：去除位置不确定的影响
- 前端电子学：Nino chips
 - 包含数字化
 - 幅度测量使用TOT
 - 14ps
- 后端电子学：HPTDC
 - 10~20ps

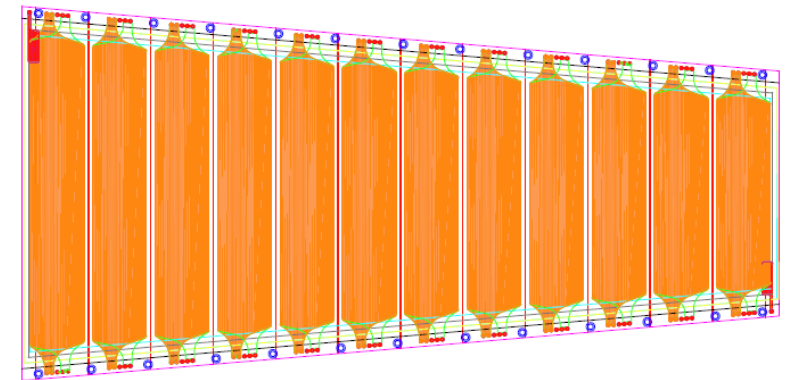
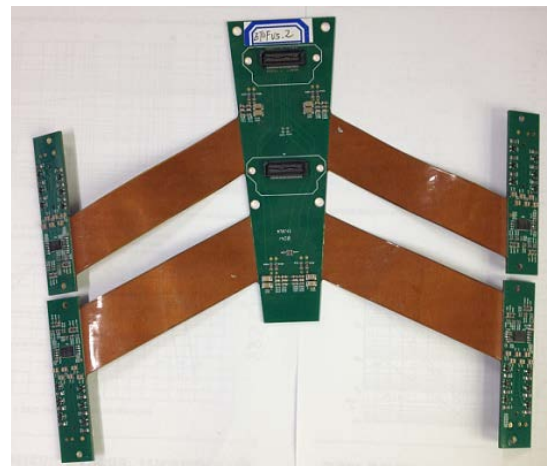
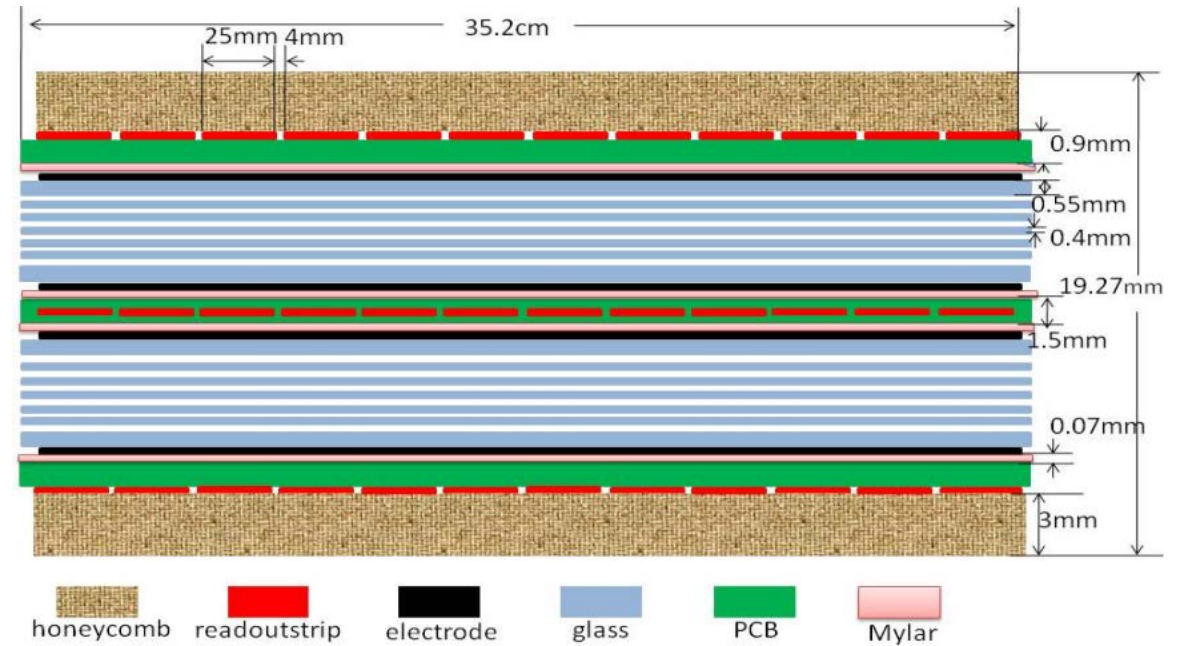

探测器设计

■ 探测器:

- 每个端盖两层, 每层厚度小于25m
- 每端36个模块, 谱仪东西端部共72个模块
- 每个模块12 strips, 双端读出

■ 电子学

- 1728路
- 前端电子学: 72 块
- 后端电子学: 24 TDIG插件
- 另有CTTP和快控制插件提供触发和控制

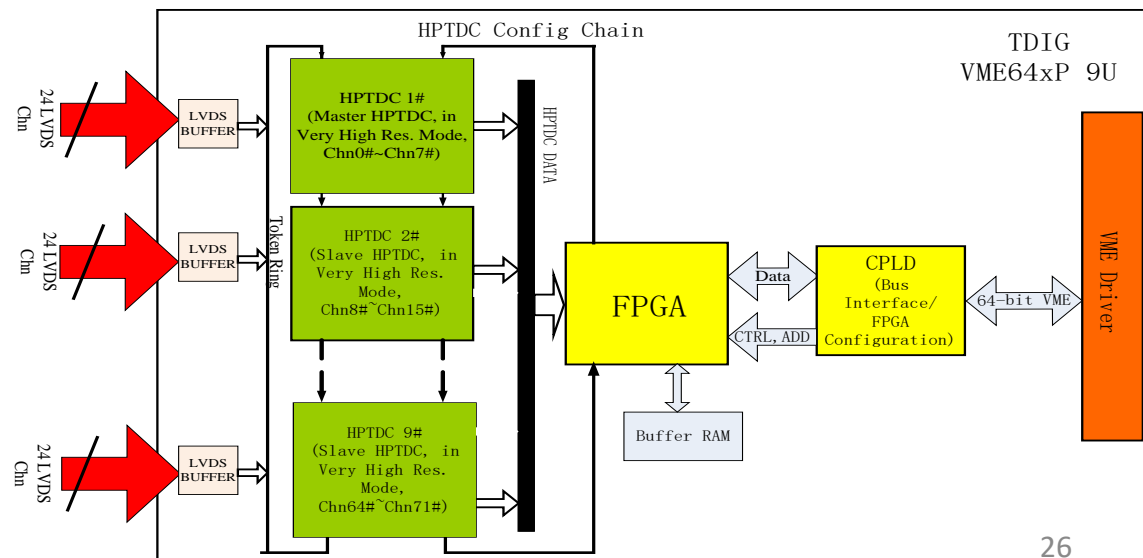
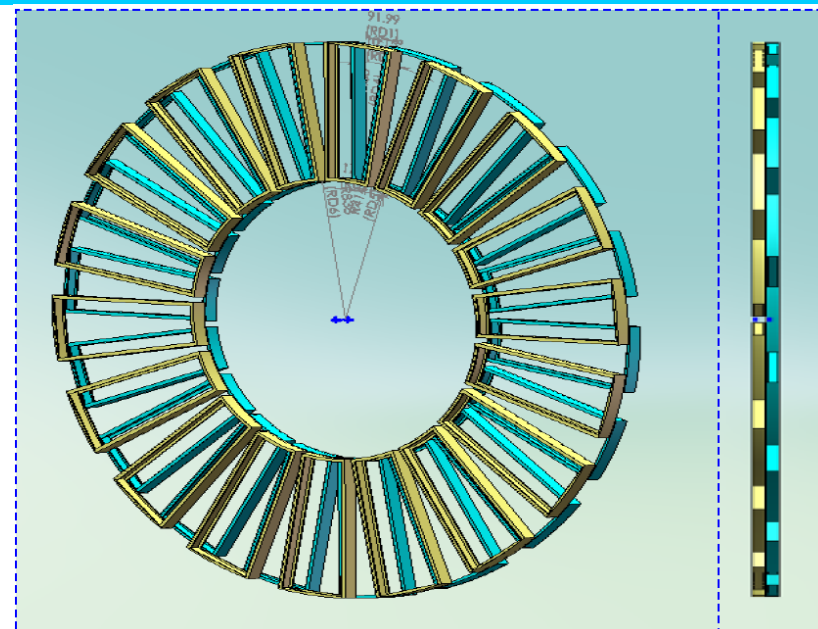

探测器建造和安装

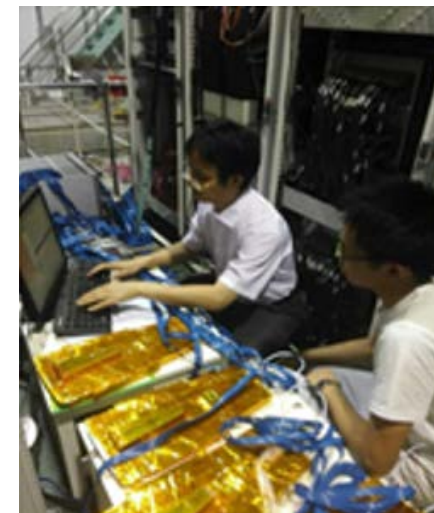

- 2015年夏季完成安装，性能稳定
- 时间分辨率大幅提高： $110\text{ps} \rightarrow \sim 60\text{ps}$

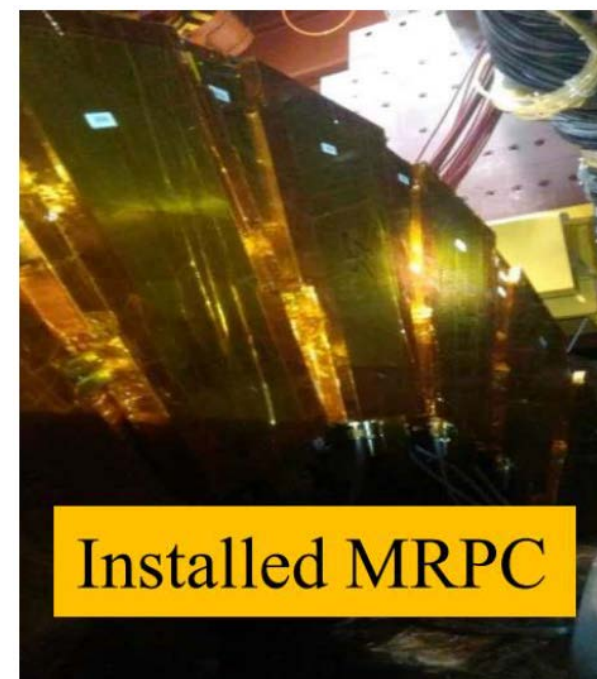
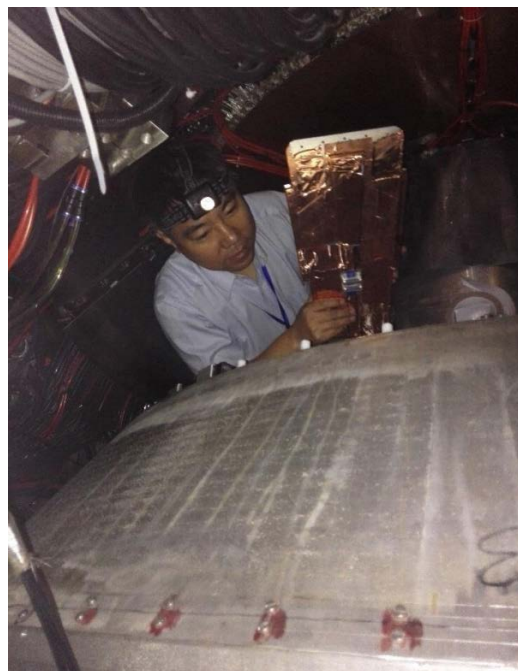

MDC aging issue

- Gains of inner chamber dropped, about 50% for the first layer cells
- No significant change in gain for outer layers
- Gain decreased by about 3% /year for layer1 and layer2, but slowed down in last three years

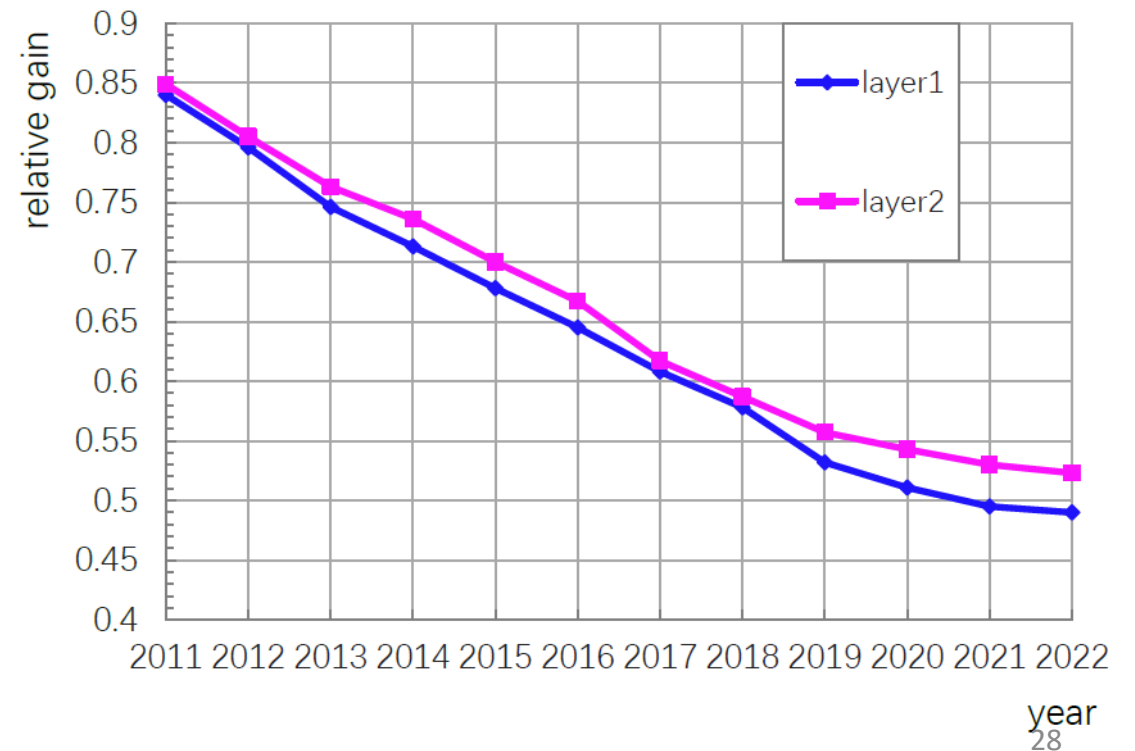
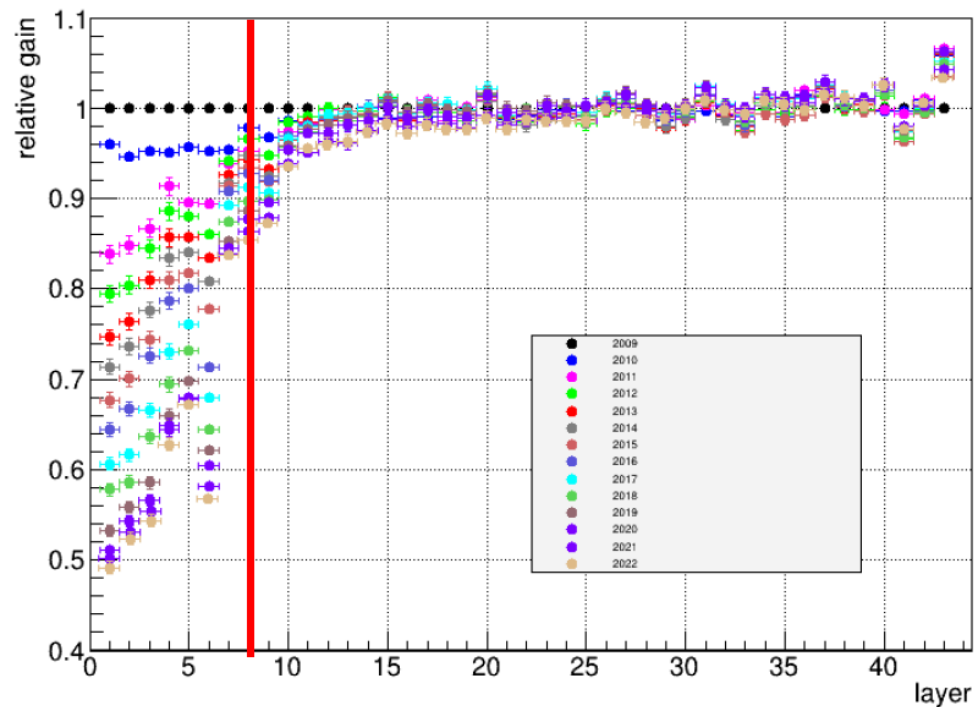

Accumulated charges

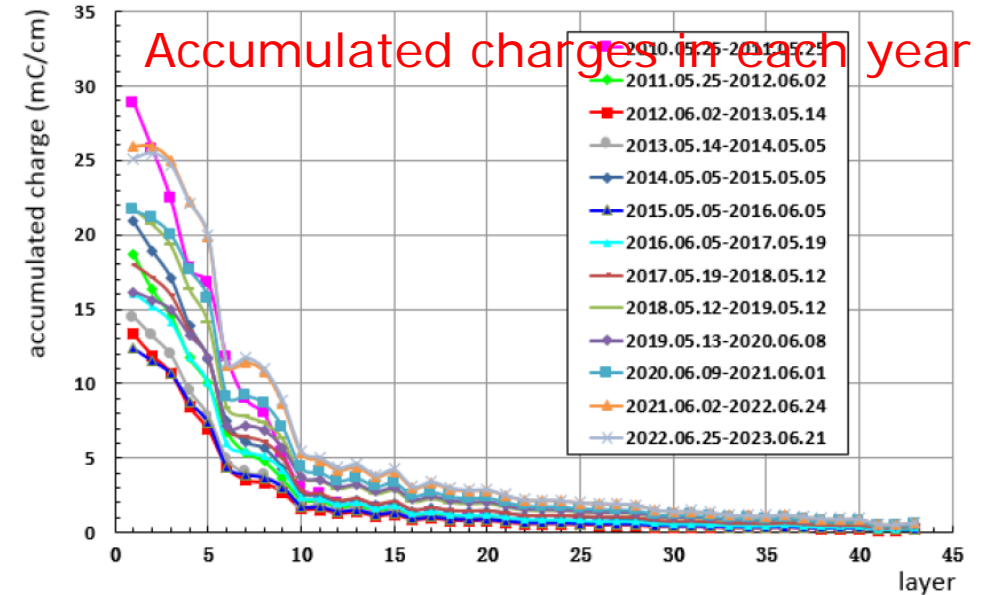
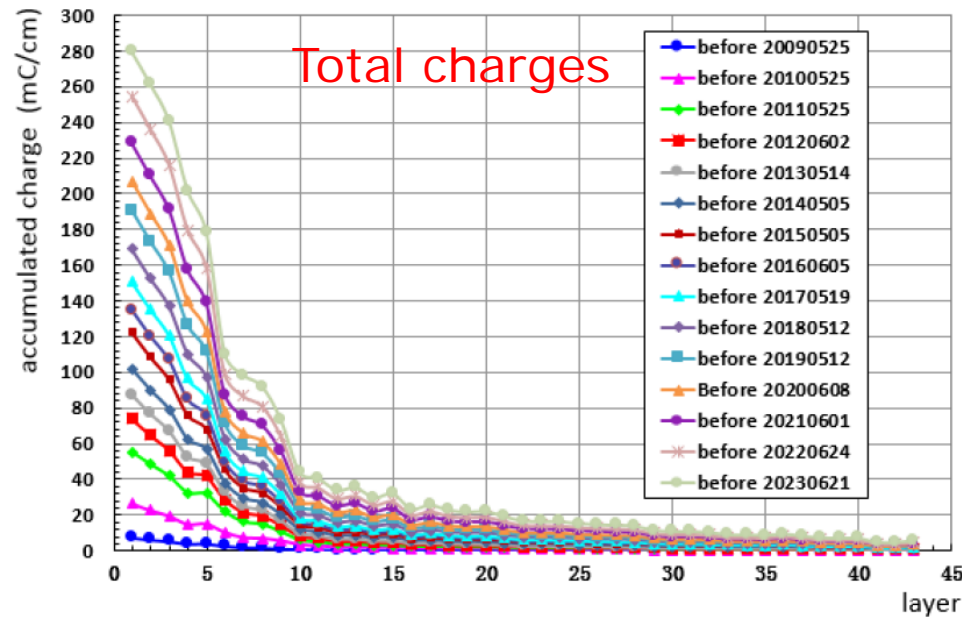

- Integrate currents of each cell to get accumulated charges
- Total charges are about 280mC/cm for the first layer
- Total charges decrease rapidly for the cells far away from the IP

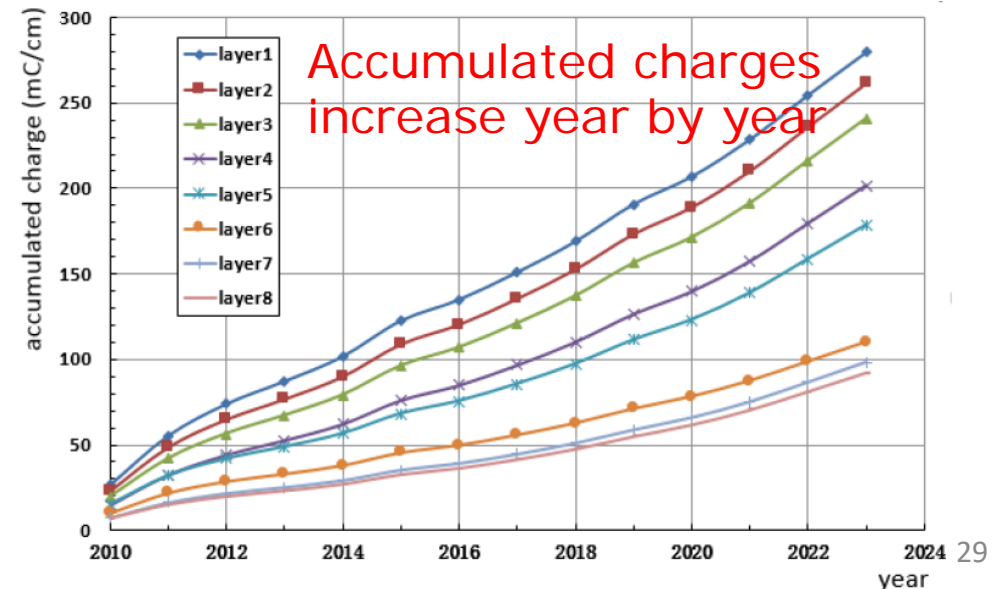

MDC spatial resolution

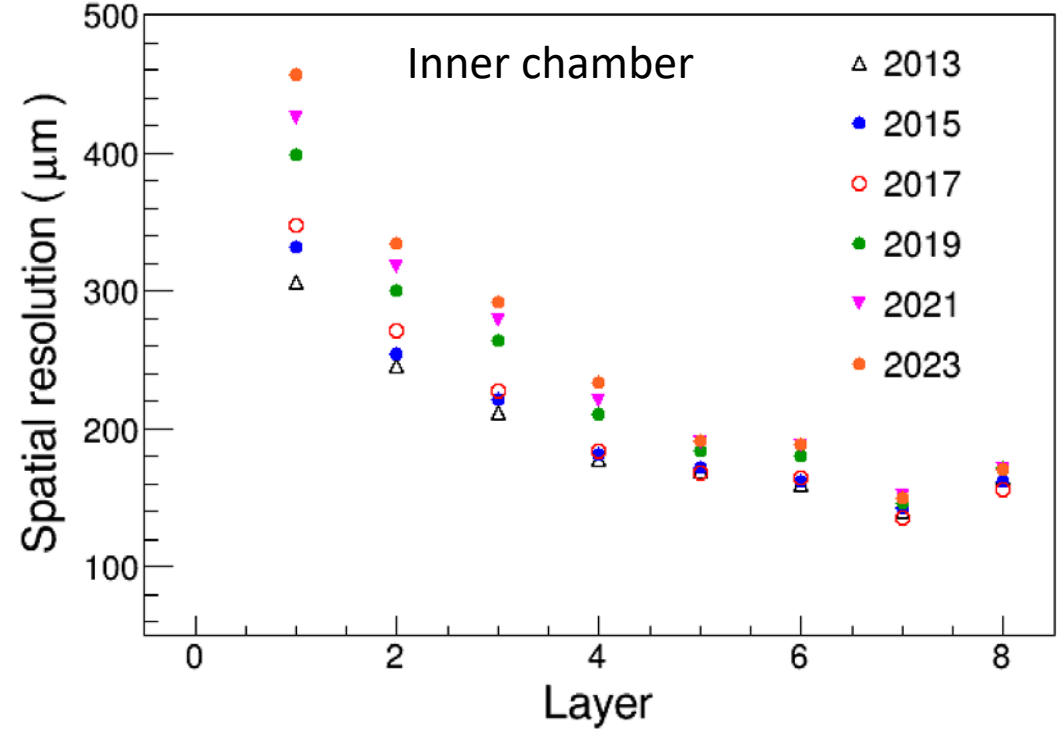
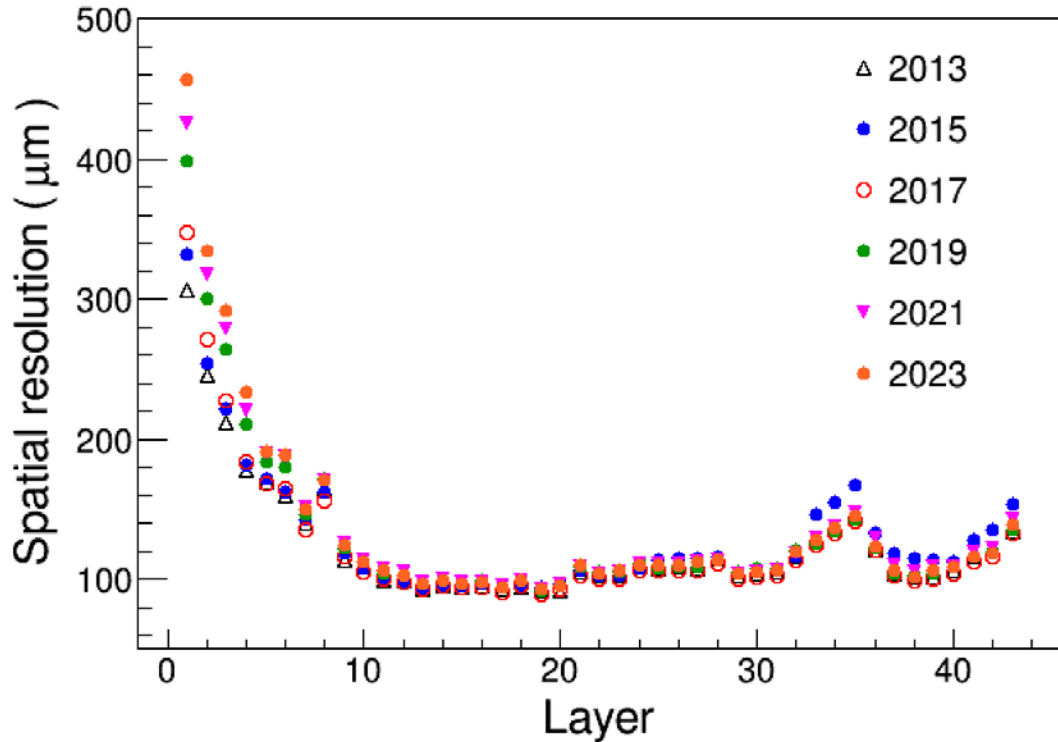

- The resolution of the inner chamber has significantly decreased
 - Decrease in gain caused by aging
 - Low voltage setting leads to low gain for the first four layers
- Almost no changes for the outer chamber

Reconstruction hit efficiency

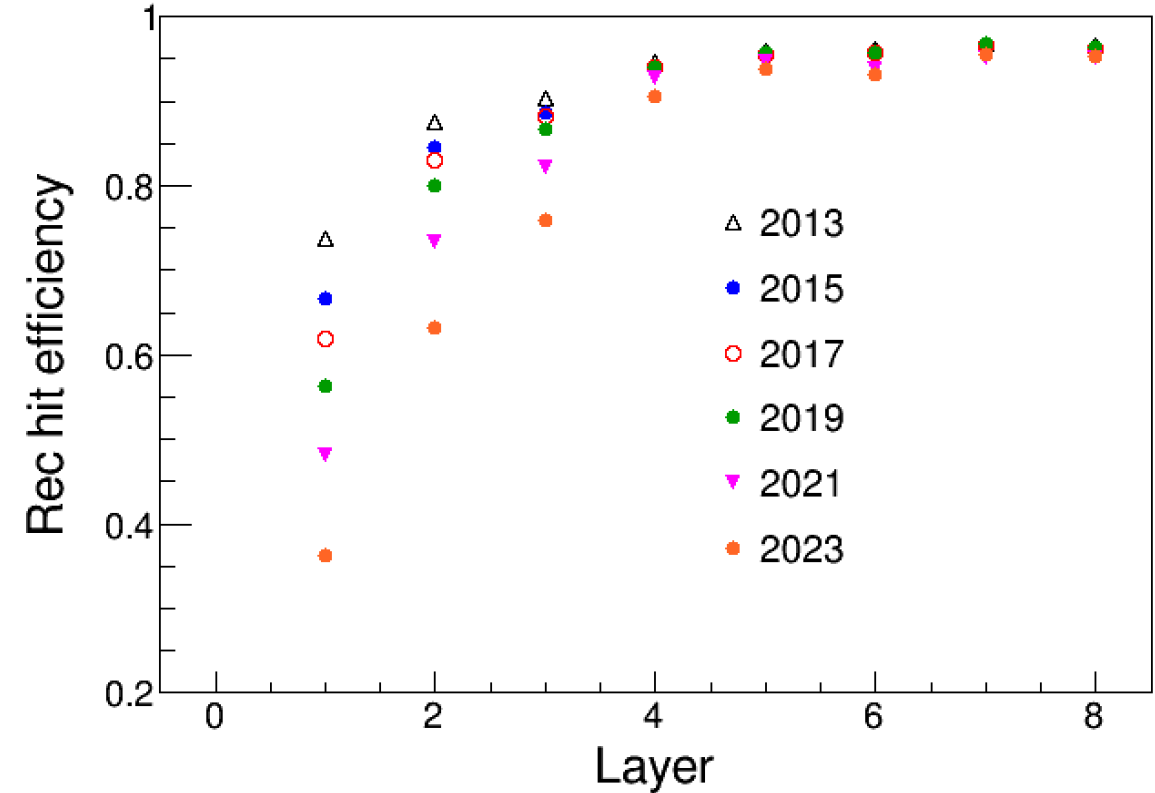
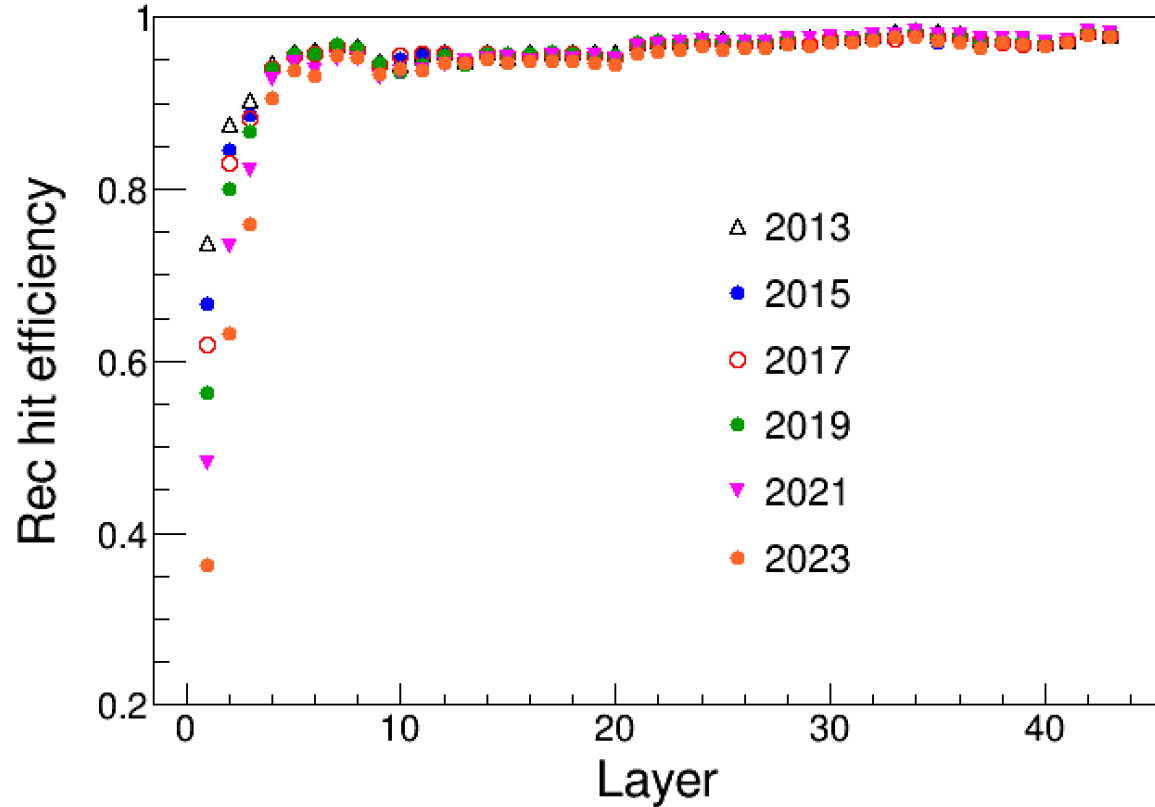

- No significant decrease for most layers
- Hit efficiency of the first three layers decreased year by year

Rec hit efficiency

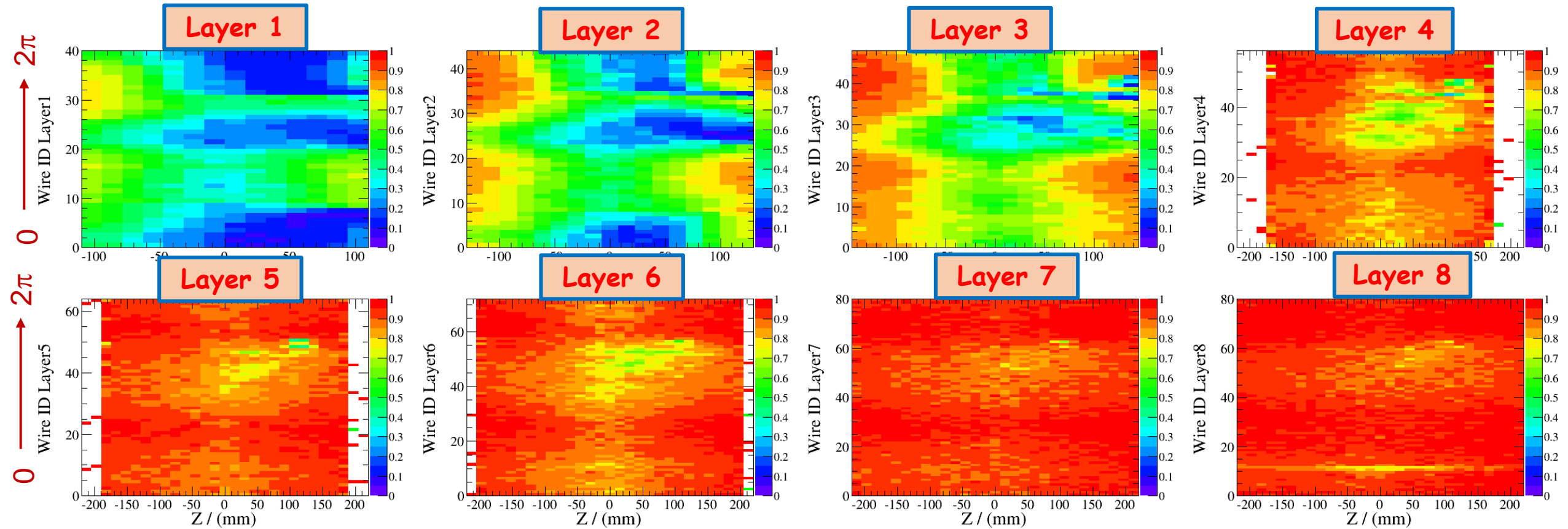

- The efficiency of the first three layers are nonuniform
- Some region is quite low ($\sim 20\%$), Signals are lower than threshold

Cylindrical GEM inner tracker (CGEM)

- Built a 3-layer cylindrical GEM inner tracker for inner drift chamber upgrade (INFN and IHEP)
 - High counting rate ($>10^4$ Hz/cm²)
 - Strong anti-aging ability
 - Significantly improve z-direction resolution (~ 1.5 mm \rightarrow ~ 0.5 mm)

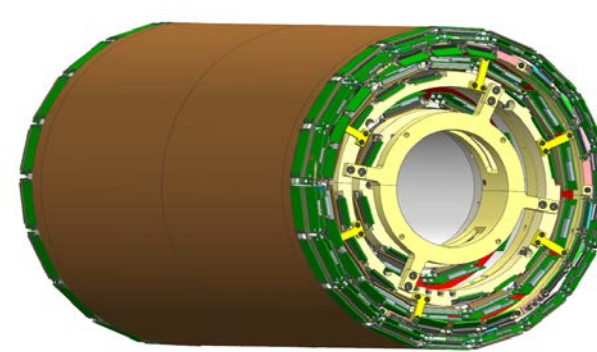

CGEM-IT

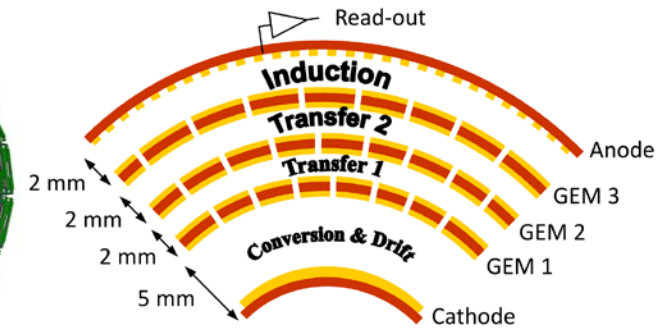

NIMA 824, (2016)515-517

先进微结构气体探测器在**BESIII**上的首次使用

Layer 1, 2, 3

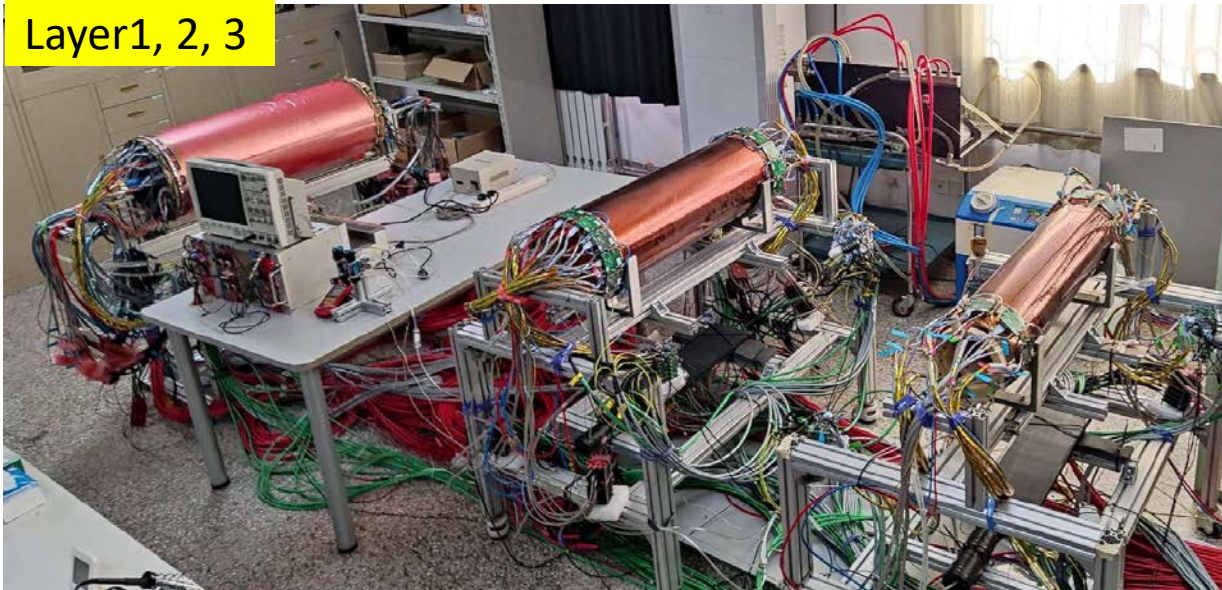

Assembled three layers together for cosmic-ray tests

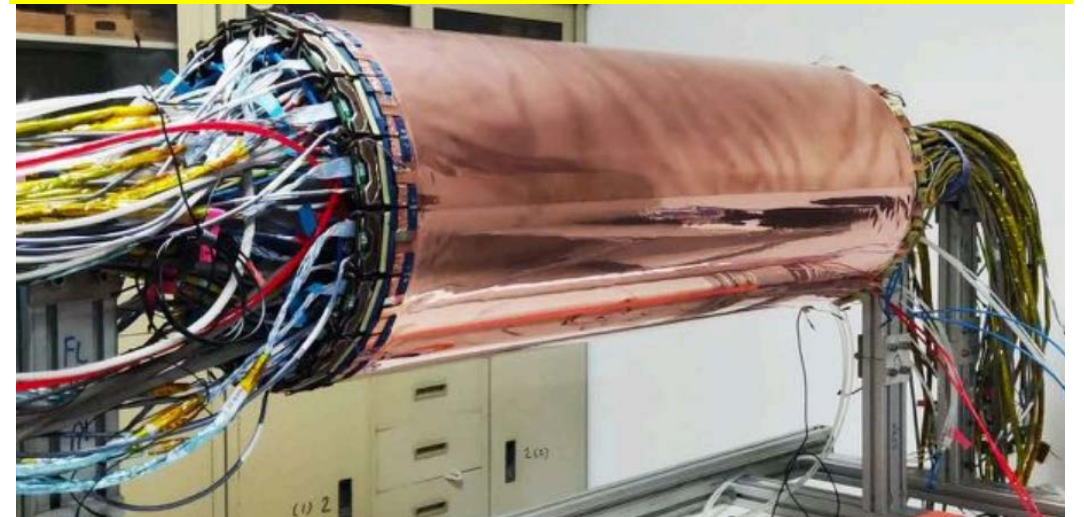

BESIII漂移室内室升级

□ 内室拆卸

- MDC内外室公用同一个腔室，在端板处紧密配合以及加胶密封，内室拆卸风险极大
- 多种拆卸方案，充分的实验，确定了最可靠的方案以及可能出现问题的预案
- 拆卸过程中，位移监测、丝张力检测，温度监测等

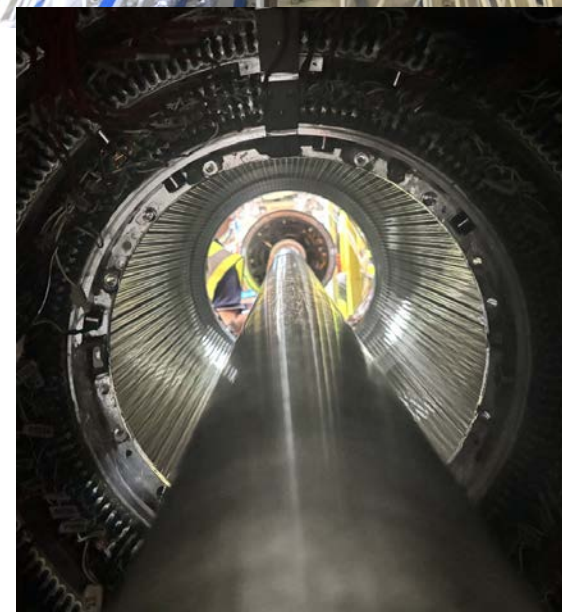
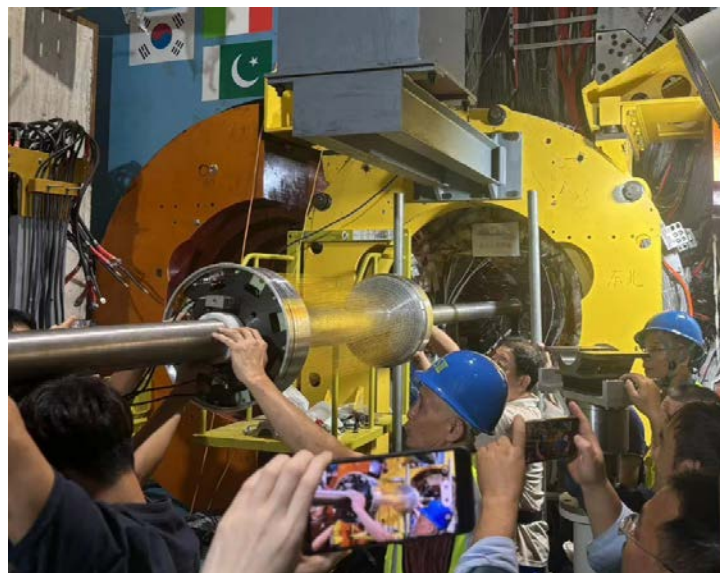
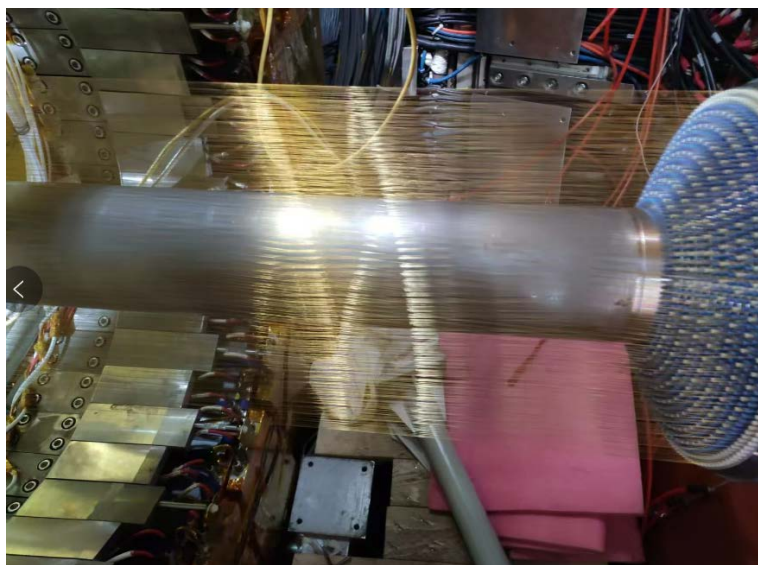

Cosmic-ray test

MDC T Hitmap Histogram

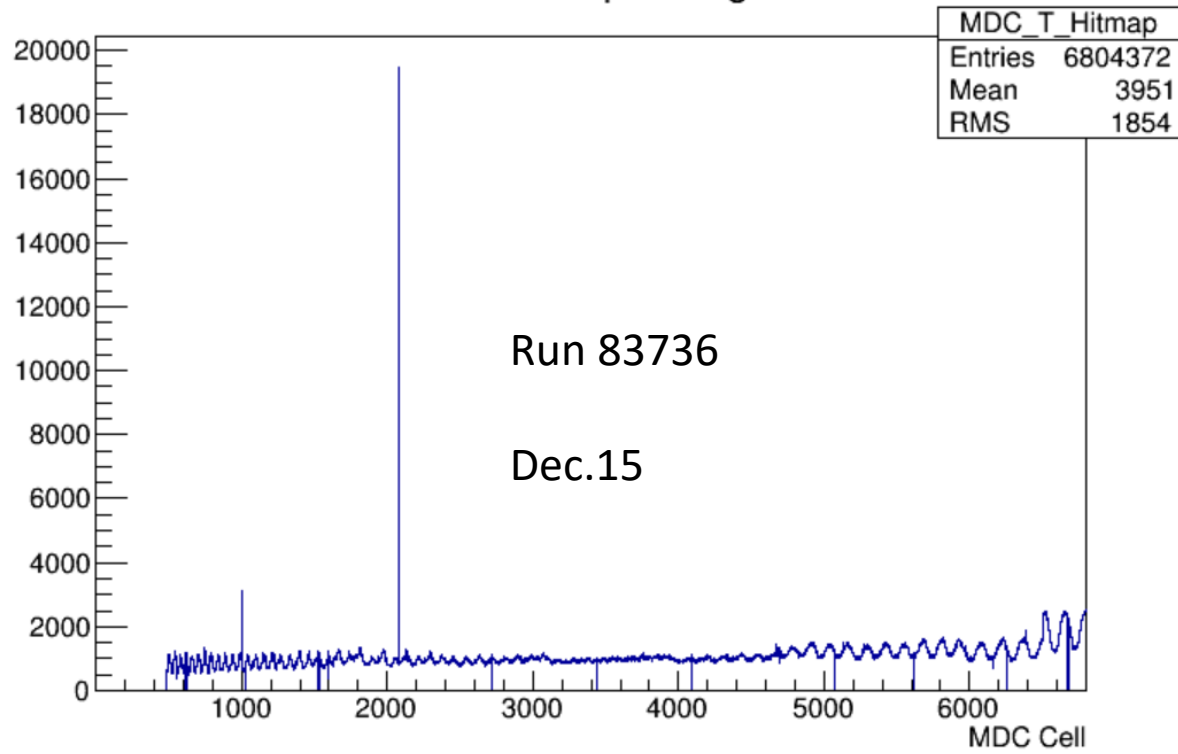

MDC Q Hitmap Histogram

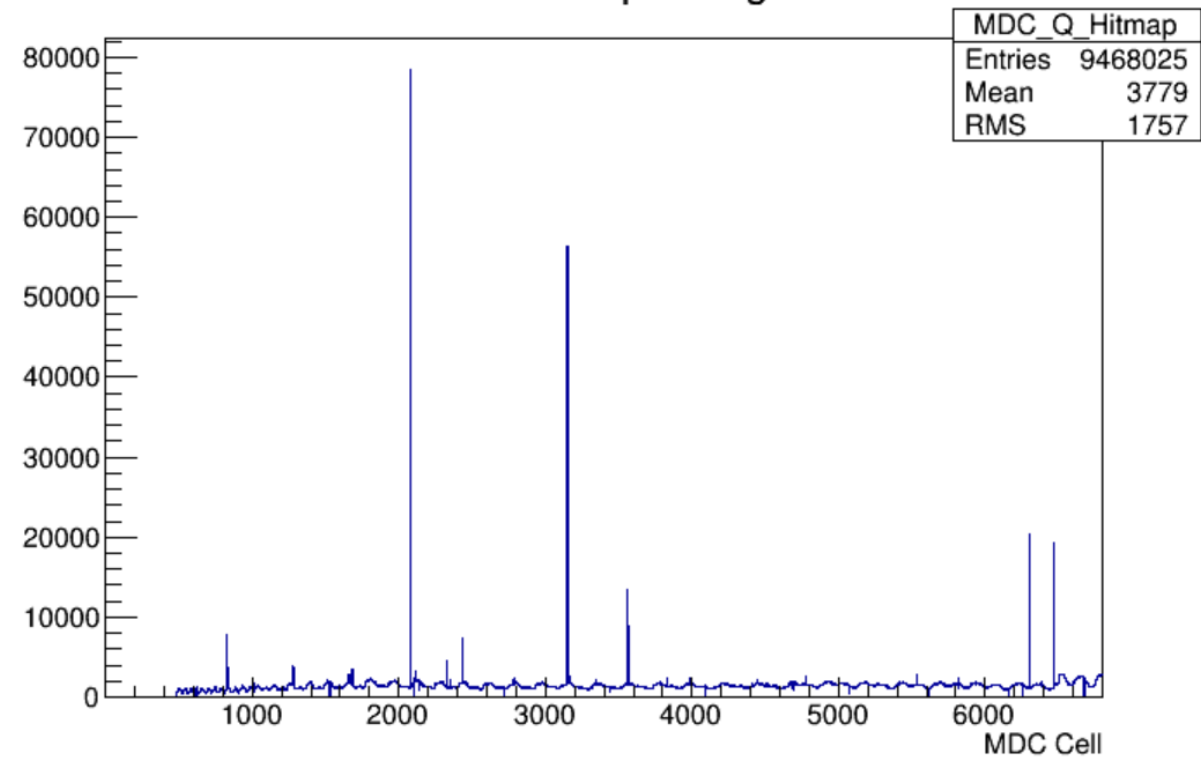

BESIII漂移室内室升级

□ CGEM的安装

- 通道数：484—>约10000
- 电缆数：增加3倍，且电缆直径大
- 安装空间紧张
- 顺利对接及联合测试
- 经过测试，CGEM可以在正常高压下工作。标志着**BESIII内径迹室升级的成功**

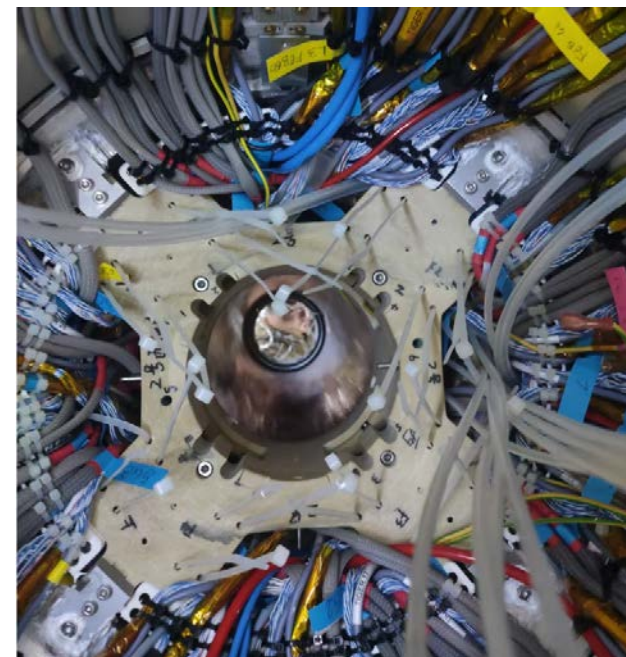
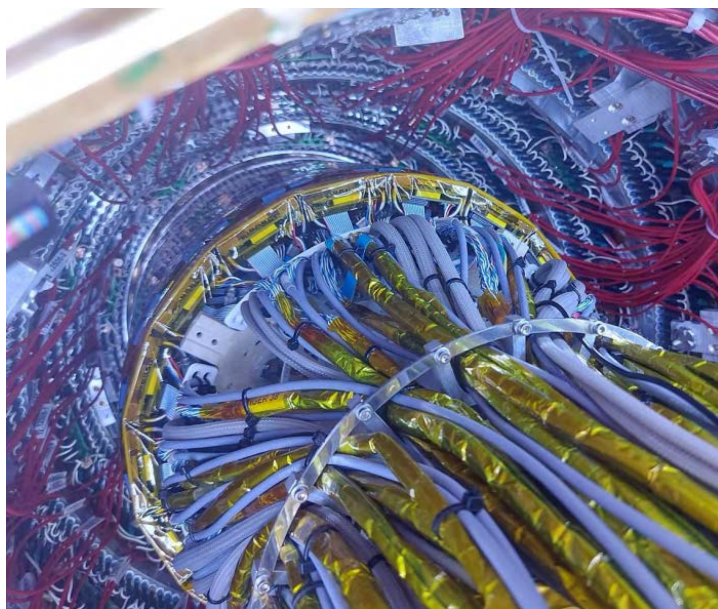
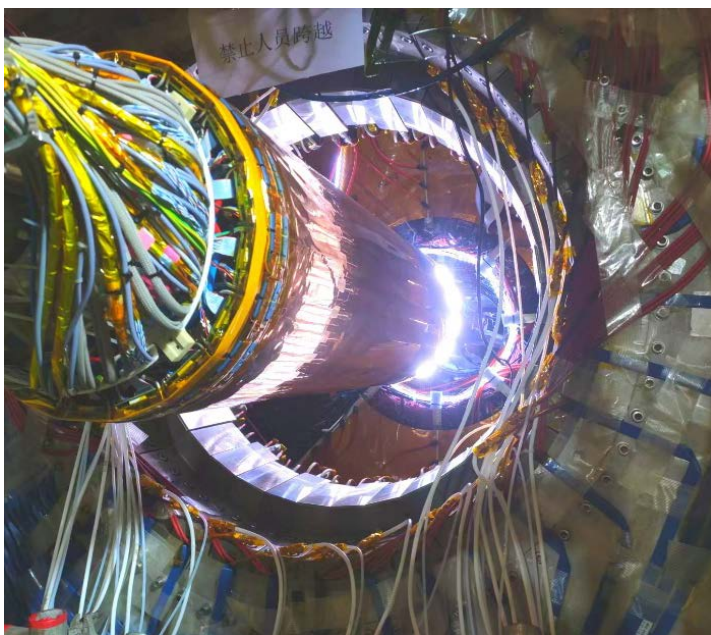
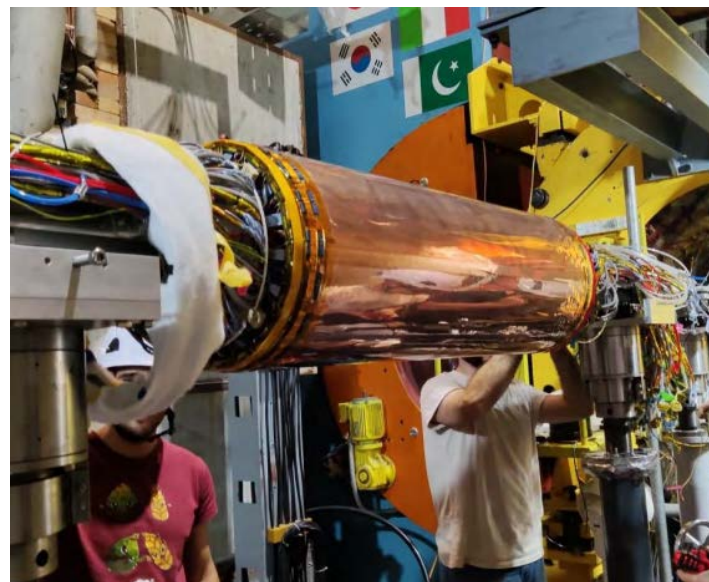

CGEM readout

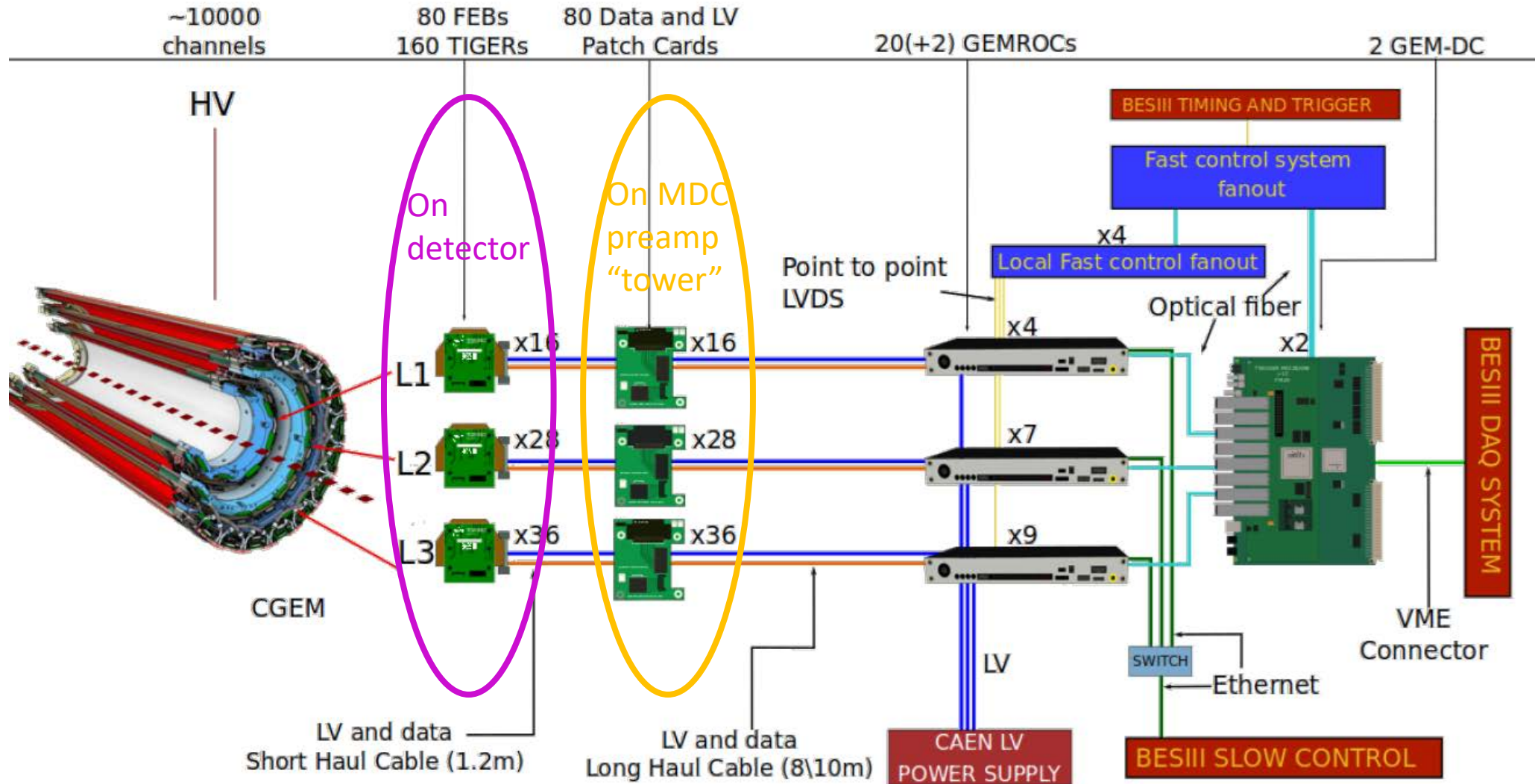

Summary

- BESIII 各子探测器性能均达到或超过设计指标。
- 已经连续运行16年，其稳定的运行状态及高精度的性能为 τ -粲物理多个前沿课题获取了大批高质量的数据，**大部分是目前世界上最大的数据样本**。
- 北京谱仪III运行以来，已陆续发表了近600篇重要的物理成果，如 $Z_c(3900)$ ， $X(2370)$ 等，为我国在高能物理研究领域达到世界先进水平做出重要贡献。
- 端盖TOF和MDC内室升级已经完成。
- BEPCII/BESIII 未来将取得更多重要物理成果，继续保持陶粲能区的物理研究处于国际领先地位。

Thanks for your attention

