

MAX IV magnet design

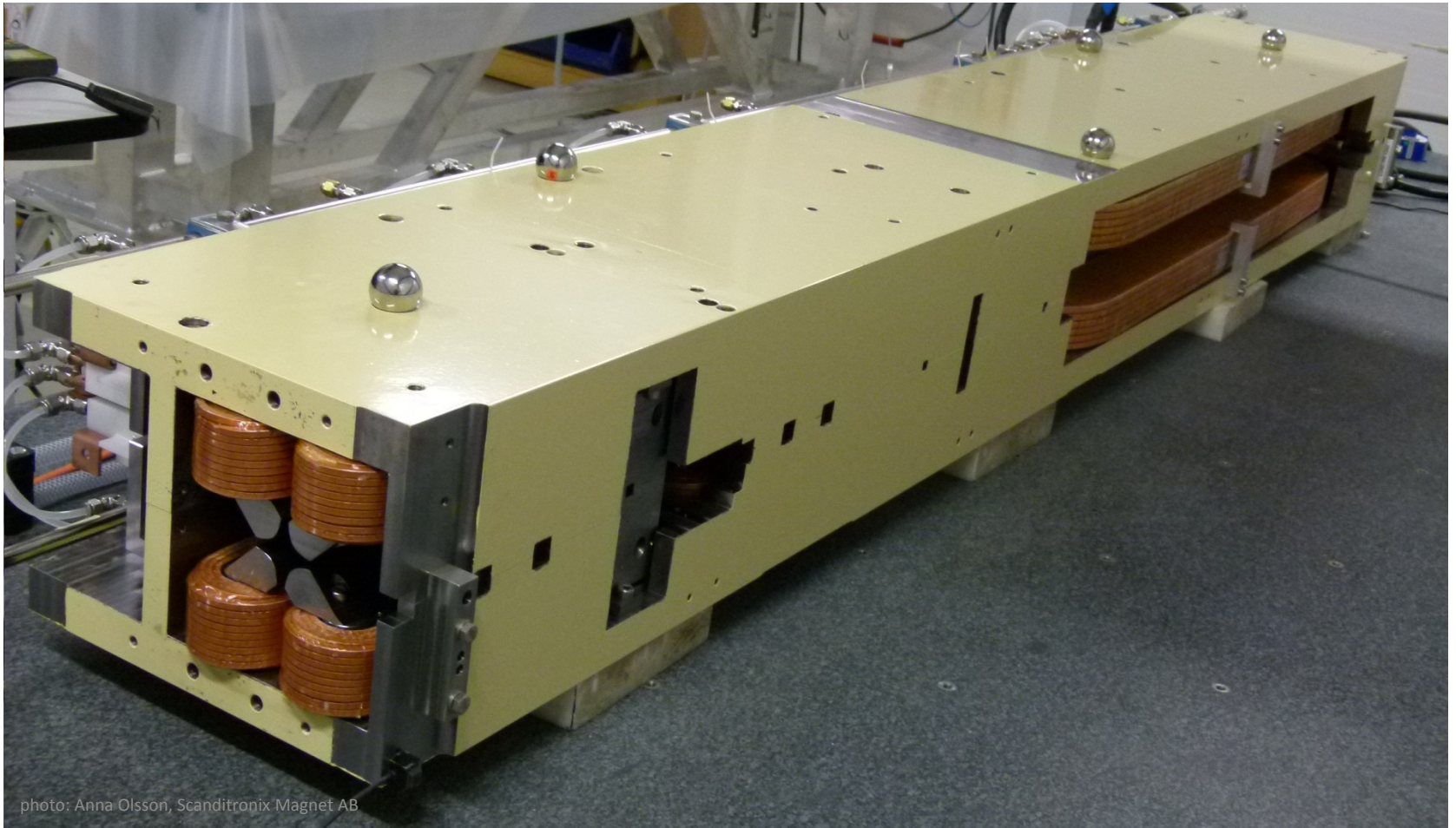
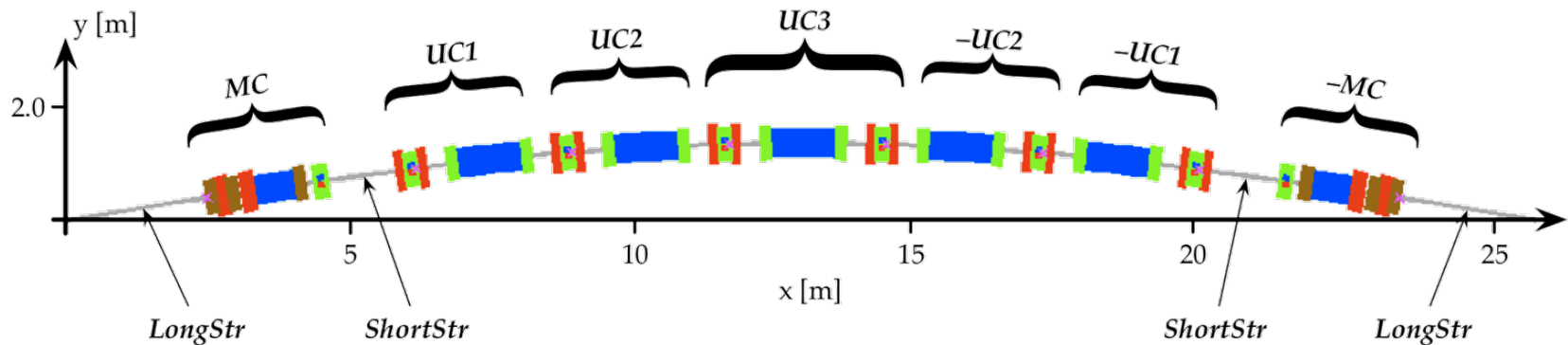

photo: Anna Olsson, Scanditronix Magnet AB

MAX IV magnet design

- 1) Presentation of the design concept.
- 2) Why have we done it like this?

MAX IV 3 GeV ring lattice:



- Each achromat consists of five unit cells and two matching cells.
- 20 achromats x 7 cells = 140 cells total
- achromat length = 26.4 m
- ring circumference = $26.4 \times 20 = 528$ m

achromat 3D cad assembly:

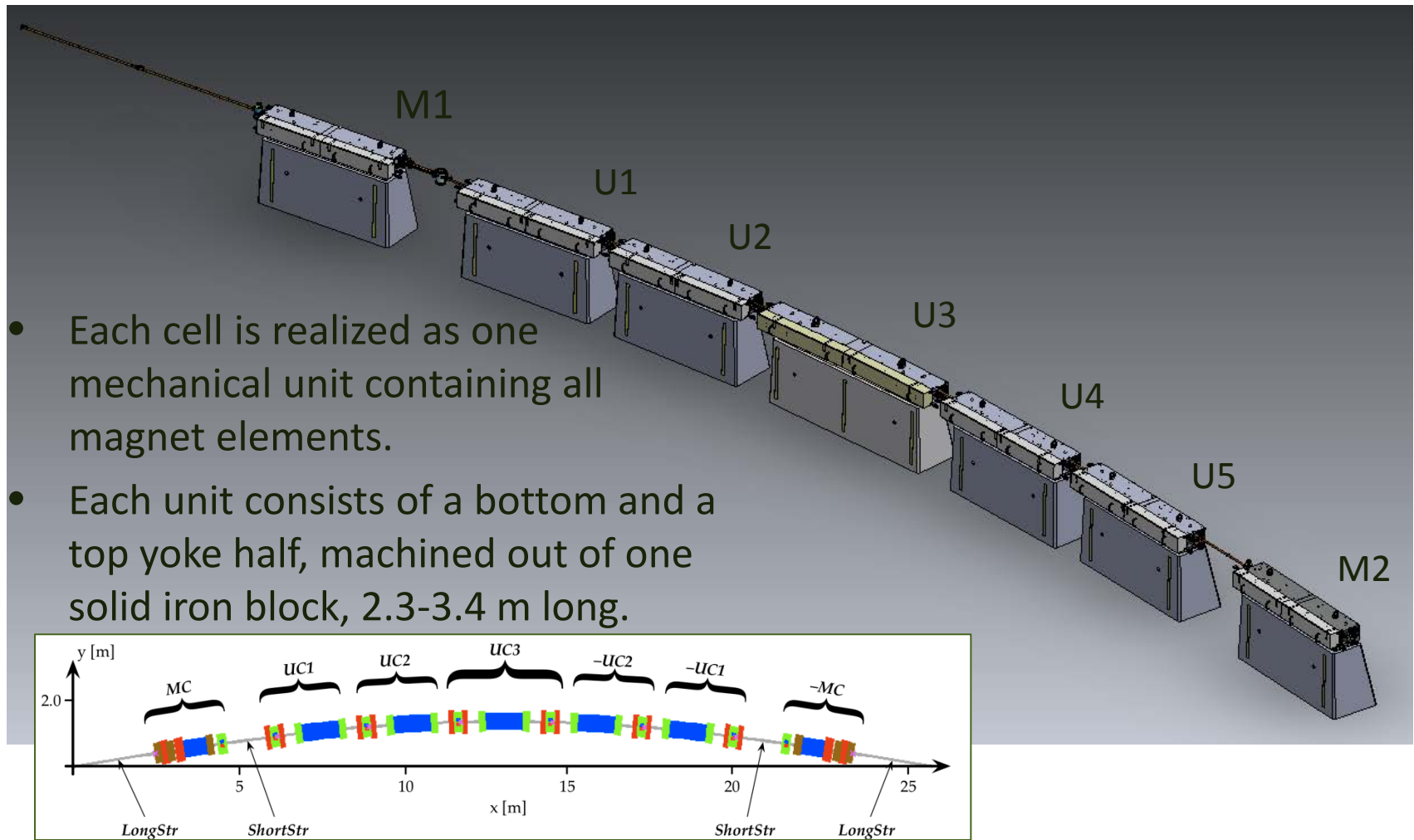

a MAX IV magnet block:

- a U5 bottom half →
- ↓ an assembled U5

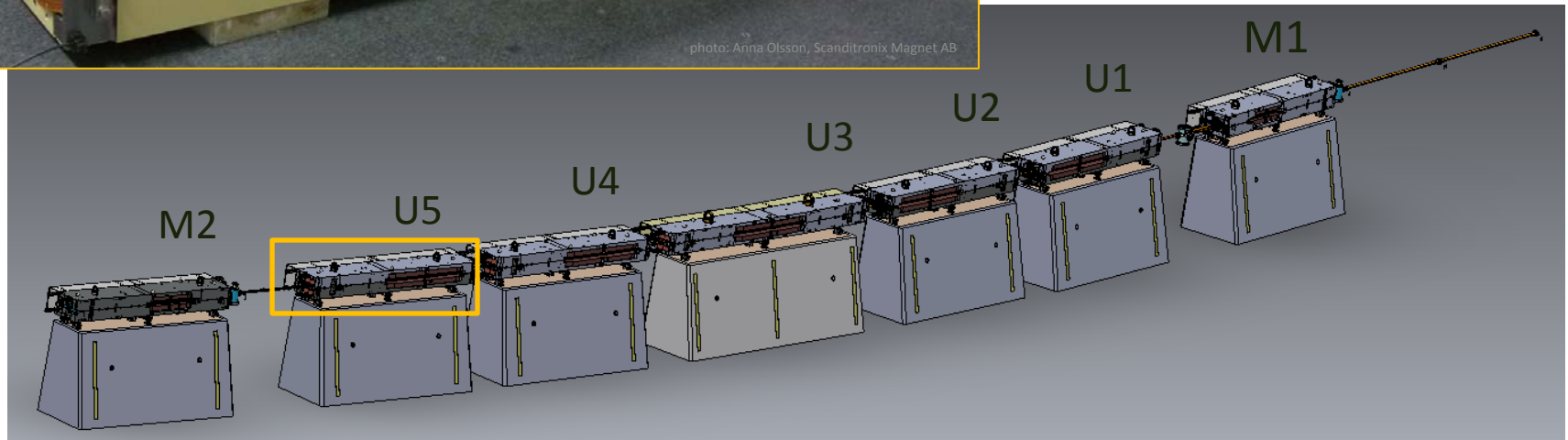

a MAX IV magnet block:

- Dismountable at horizontal midplane.
- all yoke parts = Armco low carbon steel.
- Quad and corr pole tips mounted over the coil ends.
- 6pole and 8pole magnet halves mounted into guiding slots in yoke block.
- Electrical and water connections located towards inside.

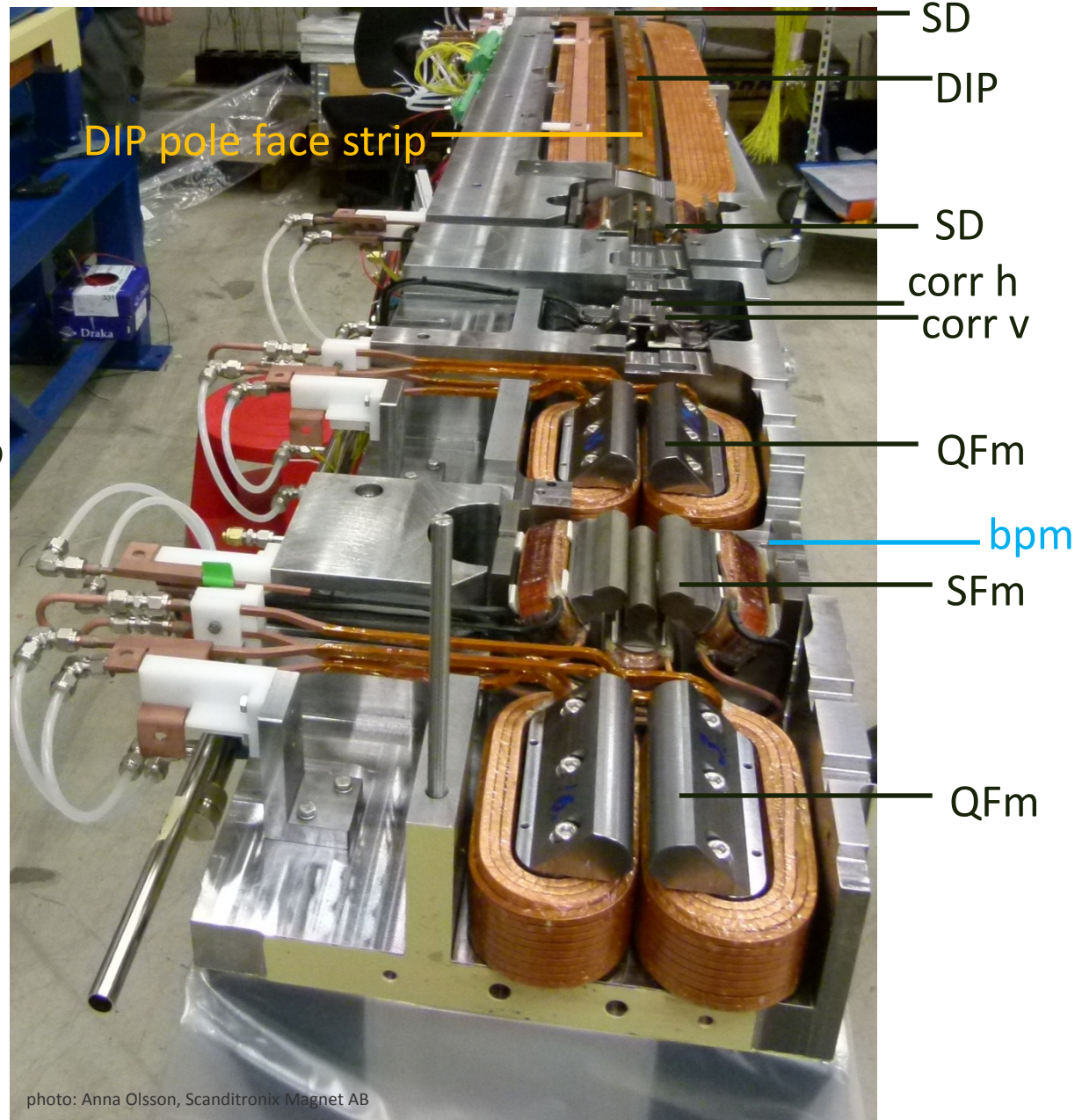
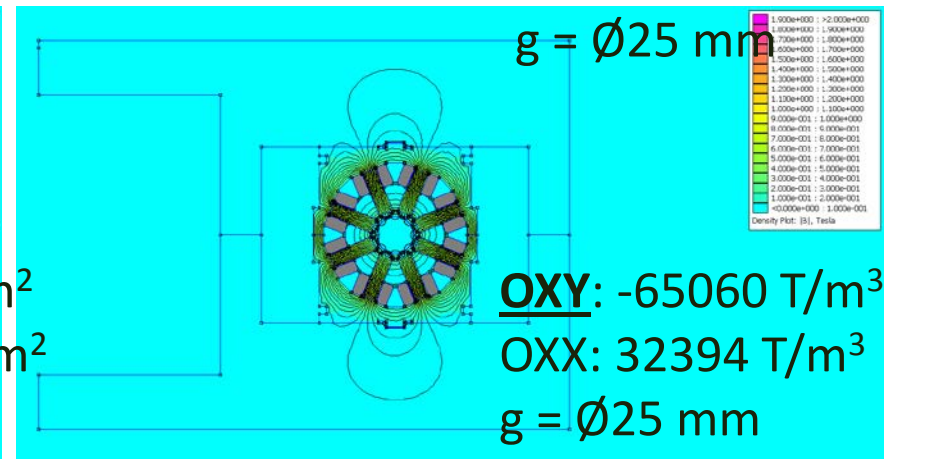
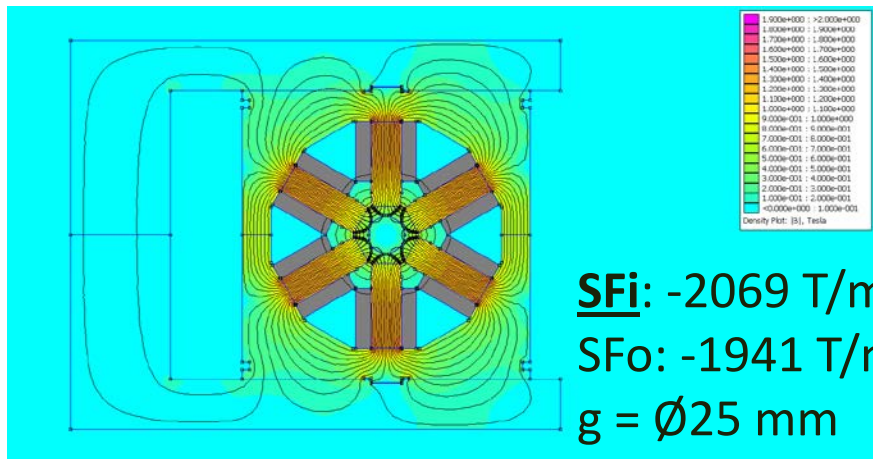
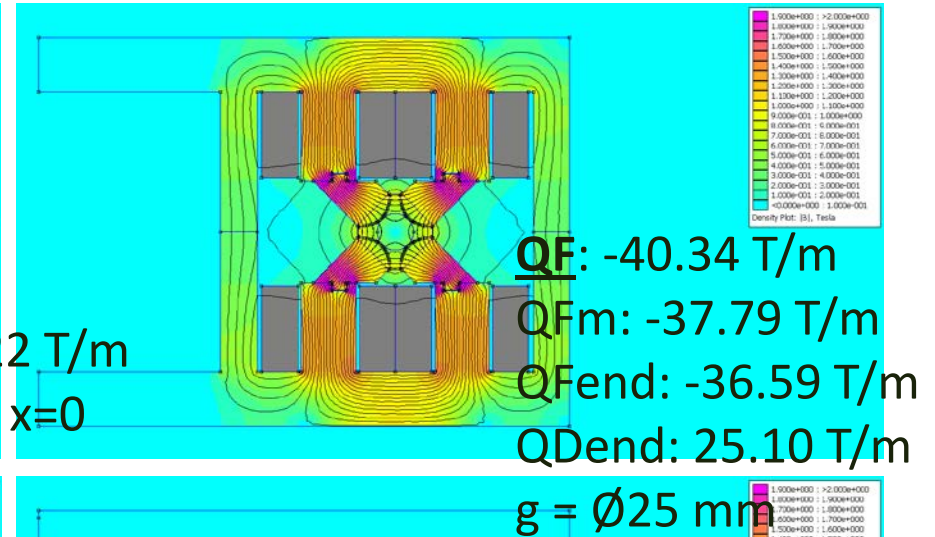
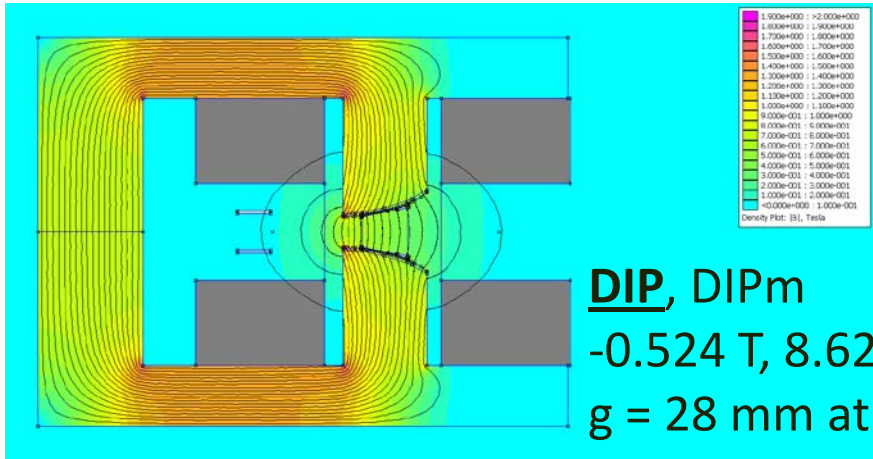

photo: Anna Olsson, Scanditronix Magnet AB

magnet elements:



... + SFm, SD, SDend ($g = \varnothing 25\text{ mm}$), OYY ($g = \varnothing 36\text{ mm}$) and corr h/v ($g = 25\text{ mm}$)

design procedure:

- 2D simulations were performed using FEMM for all magnet elements.
- 3D simulations were performed using Radia for dipoles and quads as standalone magnets, ie no 3D simulations of the full magnet blocks.

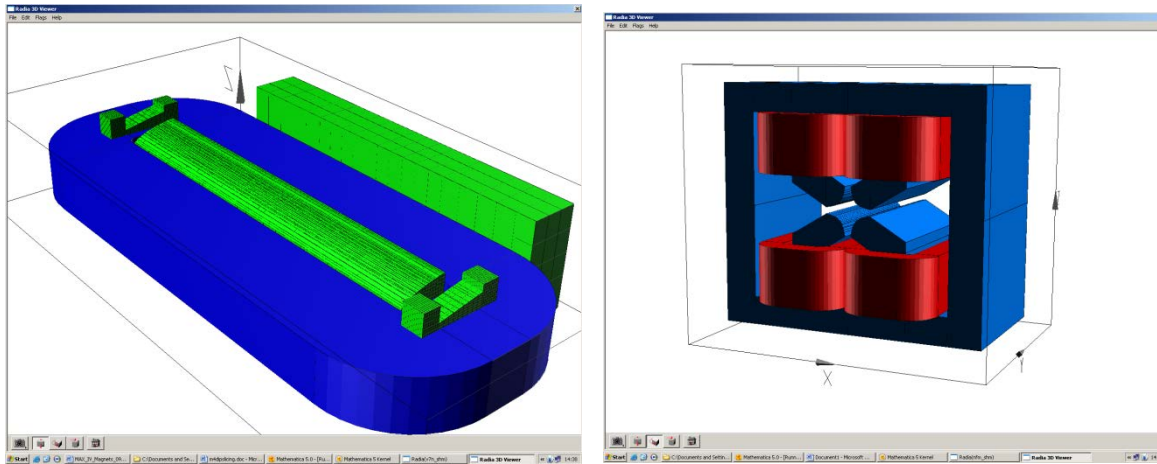

- The dipole was evaluated, and represented in the lattice, as consisting of 12 longitudinal slices.
- Lattice and magnet design were iterated against each other.

more details:

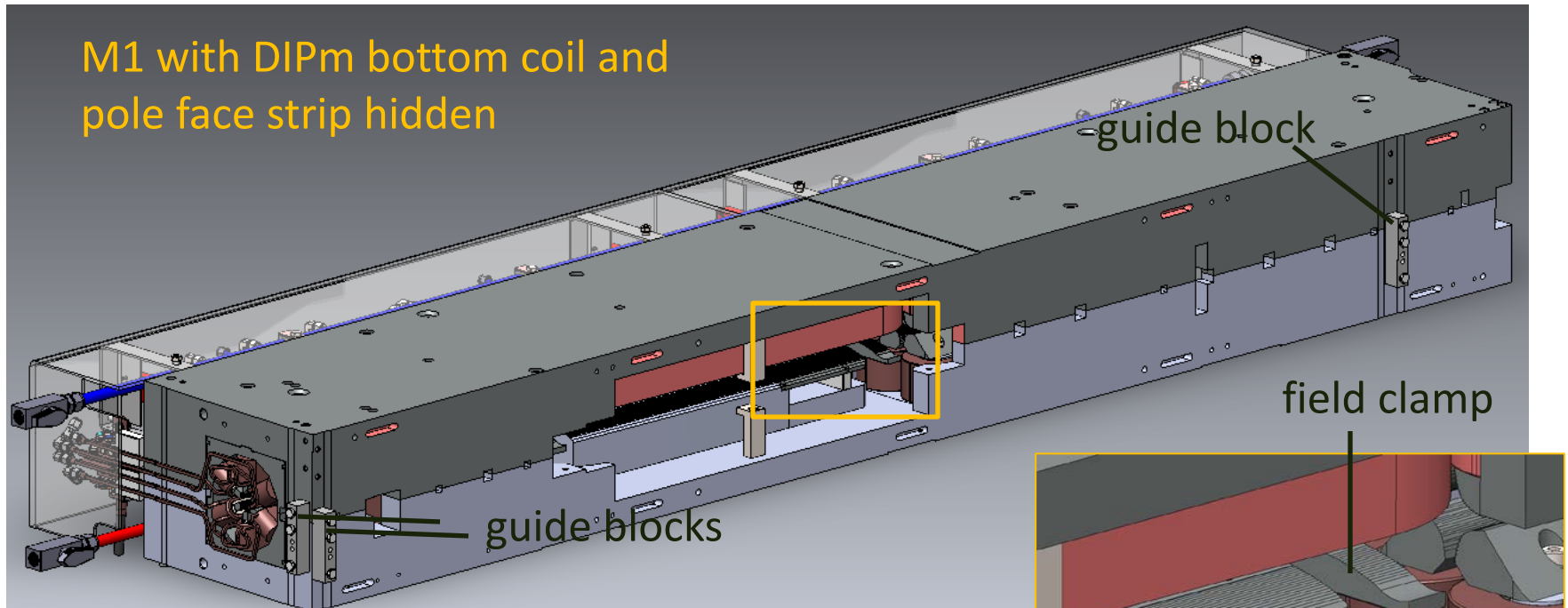

- Top half aligned to bottom half by 3 guiding blocks on bottom + top outer reference surfaces.
- Field clamps reduce the dipole fringe field distribution sensitivity to coil shape.
- M1/M2 DIPm soft end reduces thermal load to the long straight.

specification

- Suppliers deliver magnet blocks fully assembled and wired, ready to put directly in ring tunnel and connect ps and water.
- Suppliers are responsible for mechanical tolerances on parts.
- MAX IV is responsible for magnetic design.
- Mechanical tolerances on the yoke bottom and top pieces are defined relative to reference planes A, B, C and D.
- Dipole surface and quad/6pole/8pole guiding surfaces have ± 0.02 mm tolerance relative to D, A-B and C.
- Suppliers perform field measurements of all magnet elements to MAX IV instructions.

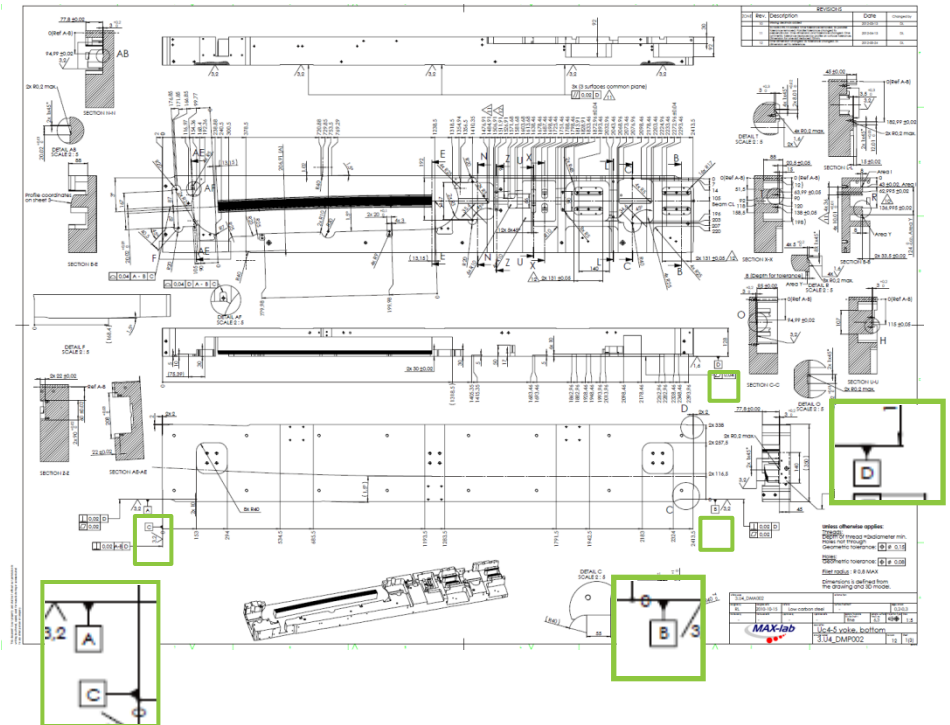

MAX IV magnet design

- 1) Presentation of the design concept.
- 2) Why have we done it like this?

why $\varnothing 25$ mm pole gap?

- The pole aperture has a direct influence on lattice compactness, by defining minimum distance between elements and minimum length for quads, 6poles, ...
- minimum distance between consecutive elements \approx one pole gap
- If shorter, fringe fields overlap, destroying field quality.

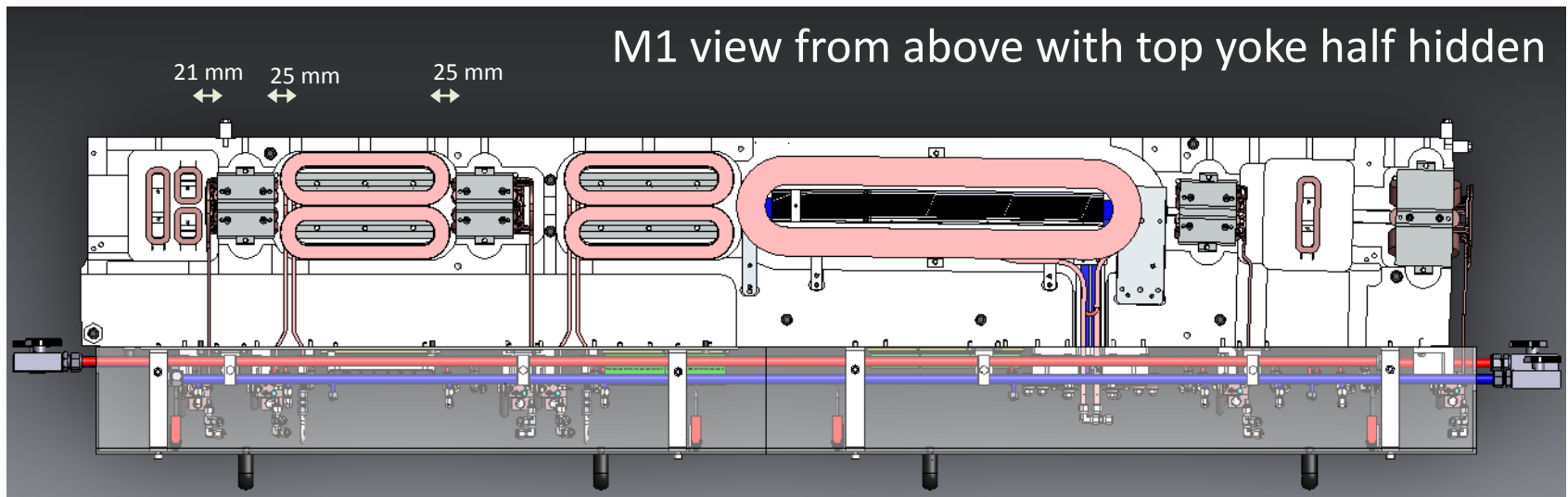

why $\varnothing 25$ mm pole gap?

- Assuming a fixed max pole tip field, B_{pt} , max quad gradient = $B_{pt}/\text{pole } r$
- We have chosen max $B_{pt} \approx 0.5$ T, which keeps the whole pole face in the linear region of the iron $B(H)$ curve. Resulting max $G \approx 40$ T/m.
- Our quads are at or close to this strength, so with larger pole radius, they would have needed to be longer.
- Our 6 poles are in the same situation, at minimum length for this pole gap.

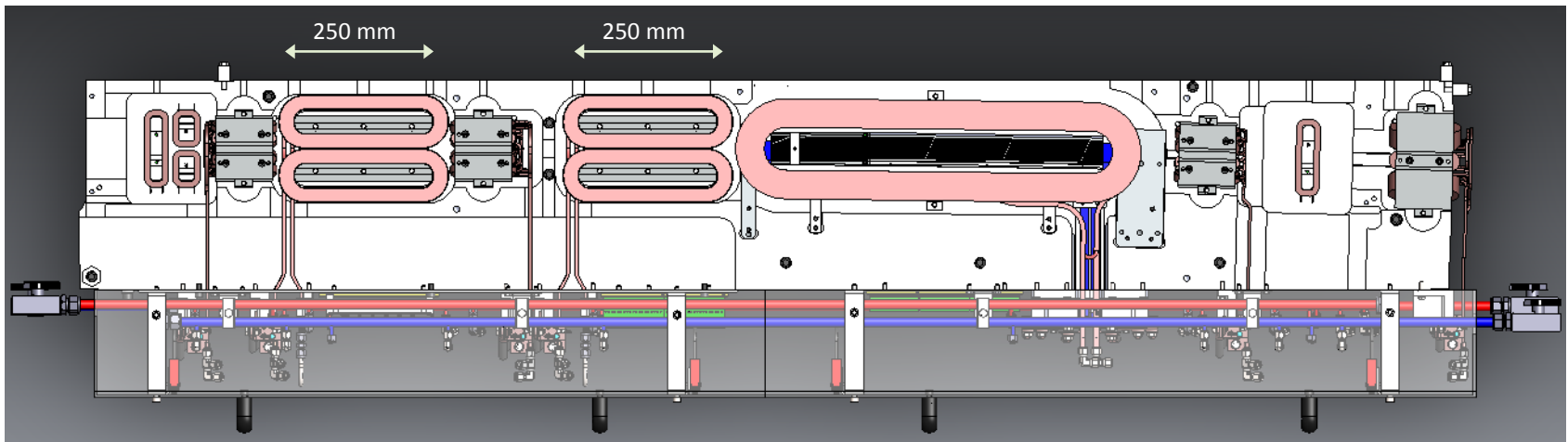

why Ø25 mm pole gap?

- The pole gap also has an indirect influence on lattice compactness through coil design, in that the required NI is proportional to g for dipoles, $(g/2)^2$ for quads, $(g/2)^3$ for 6poles, ... making it easier to fit the coil ends longitudinally between consecutive magnet elements for smaller pole gaps.
- A negative aspect is that with smaller pole gap, the relative strength of random field errors due to manufacturing tolerances increase, since the tolerances are fixed, constituting a larger fraction of the pole gap.
- Another consequence with smaller pole gap is that vacuum conductance decreases, in our case necessitating distributed pumping.

why the magnet block concept?

As opposed to standalone magnets not sharing a common return yoke...

- First of all, separate magnets on individual adjustment stands were never considered, because
 - we assumed that optical alignment would be less accurate between consecutive elements.
 - given the small footprint of our magnet elements, designing adjustment stands stiff enough to give the same level of vibration stability would have been difficult.
- So, from the perspectives of alignment and vibration stability, we were looking at a solution with several consecutive magnet elements in the same mechanical unit.
- Then there are two paths...

why the magnet block concept?

Two possibilities for girders

Based on field meas. data

for example NSLS-II girders:



↑ individual magnet vertical and sideways positions adjusted to stretched wire field meas. data.

Based on mech. tolerances

for example MAX II girders:



↑ Girders have precision machined fixed mating surfaces for each magnet element.

why the magnet block concept?

- At MAX IV, we typically want to subcontract as much work as possible to industry, minimizing the internal personnel need.
- We therefore chose an alignment concept based on mechanical tolerances over field meas. believing this is easier to subcontract to industry.

why the magnet block concept?

- DIP and QF cross sections →
- Separate magnets on a girder requires one more mating surface, decreasing the alignment accuracy. Therefore the magnet block concept.
- Expected rms alignment as sum of squares of squares of parts, $x,y = \pm 0.016, \pm 0.020$ for dipoles, $= \pm 0.018, \pm 0.021$ for quads, $= \pm 0.023, \pm 0.025$ for quads, with pessimistic assumption each part at max tolerance.
- Also, it is easier to achieve good vibrational stability with the magnet block concept. Lowest eigenfrequency ≈ 90 Hz for MAX IV, vs ≈ 30 Hz for MAX II.

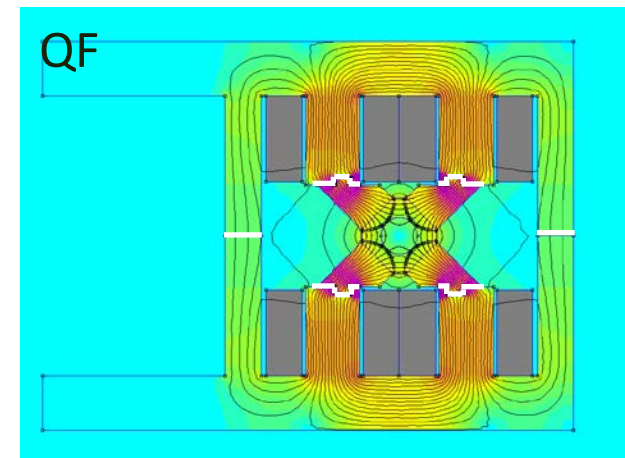
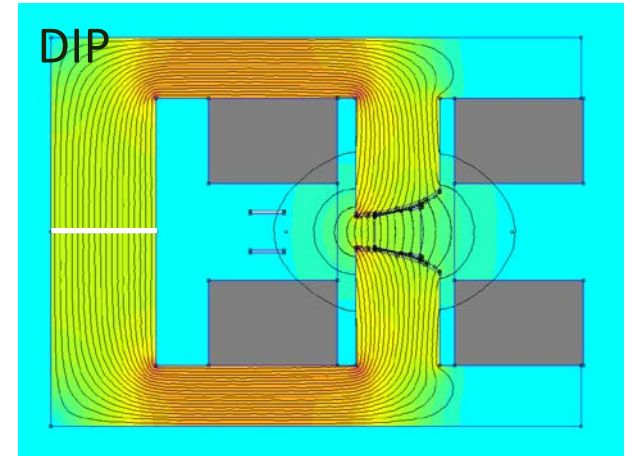

Thank you for your attention!