

Relative strong phase in $D^0 \rightarrow K\pi$ decay measurement at BESIII

Xiao-Kang Zhou

(E-mail:zhouxiaokang08@mails.ucas.ac.cn)

University of Chinese Academy of Sciences (UCAS)

2013.9.06

Neutral D Mixing

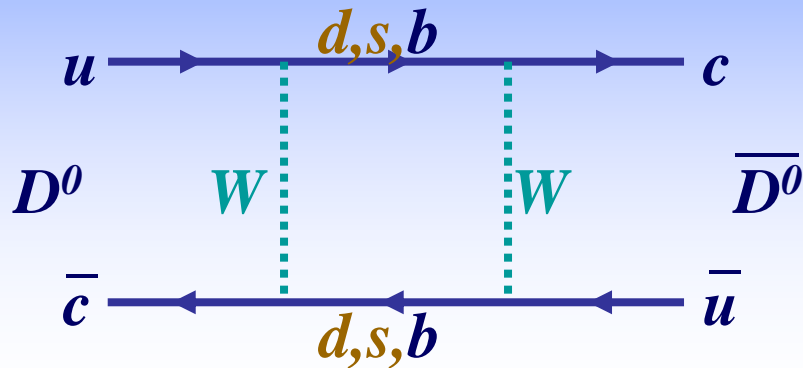

$$x = \frac{\Delta M}{\Gamma}, y = \frac{\Delta \Gamma}{2\Gamma}$$

- Charm mixing is highly suppressed by GIM mechanism and CKM matrix elements within Standard Model.
- Observation of $D\bar{D}$ mixing (LHCb 2012): Time-dependent $WS D^0 \rightarrow K^+\pi^-$ -rate: $y' = y \cos \delta_{K\pi} - x \sin \delta_{K\pi} = (0.72 \pm 0.24)\%$
- Important for testing SM & searching for physics beyond the SM

Strong Phase in $D^0 \rightarrow K^- \pi^+$

- Hadronic parameters for $K^- \pi^+$: $\frac{A(\overline{D^0} \rightarrow K^- \pi^+)}{A(D^0 \rightarrow K^- \pi^+)} = -r_D e^{-i\delta_{K\pi}}$

- Implication:

- Time-dependent analysis, relate (x', y') to (x, y)

$$x' = x \cos \delta_{K\pi} + y \sin \delta_{K\pi}$$

$$y' = y \cos \delta_{K\pi} - x \sin \delta_{K\pi}$$

- γ/ϕ_3 measurements from $B \rightarrow D^0 K$

Atwood, Dunietz & Soni (ADS): Use doubly Cabibbo-suppressed decay: e.g. $\overline{D^0} \rightarrow K^- \pi^+$

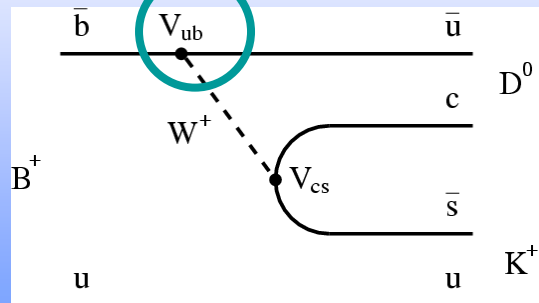
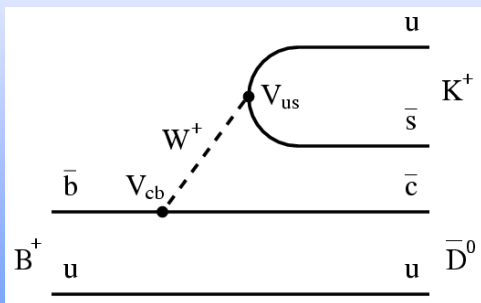

$$\frac{A(B^+ \rightarrow D^0 K^+)}{A(B^+ \rightarrow \overline{D^0} K^+)} \equiv r_B e^{i(\delta_B + \phi_3)}$$

Method to Determine $\delta_{K\pi}$

- Assuming CP conservation:

$$\langle K^- \pi^+ | D_{CP\pm} \rangle = (\langle K^- \pi^+ | D^0 \rangle \pm \langle K^- \pi^+ | \overline{D^0} \rangle) / \sqrt{2} \Rightarrow \sqrt{2} A_{CP\pm} = A_{K^- \pi^+} + \overline{A_{K^- \pi^+}}$$

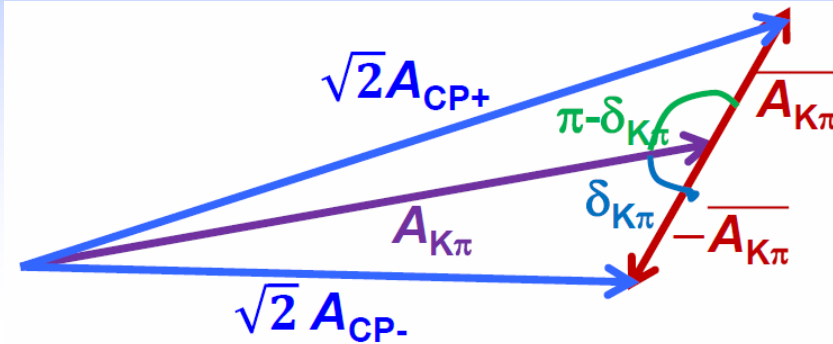

$$\Rightarrow 2r_D \cos \delta_{K\pi} \approx \frac{|A_{CP-}|^2 - |A_{CP+}|^2}{|A_{CP-}|^2 + |A_{CP+}|^2}$$

- If we do not ignore the mixing effect:

$$2r_D \cos \delta_{K\pi} + y = (1 + R_{WS}) A_{CP \rightarrow K\pi}$$

$$(R_{WS} = \frac{\Gamma(\overline{D^0} \rightarrow K^- \pi^+)}{\Gamma(D^0 \rightarrow K^- \pi^+)} = r_D^2 + r_D y' + \frac{x^2 + y^2}{2})$$

$$A_{CP \rightarrow K\pi} = \frac{Br(D_{CP-} \rightarrow K\pi) - Br(D_{CP+} \rightarrow K\pi)}{Br(D_{CP-} \rightarrow K\pi) + Br(D_{CP+} \rightarrow K\pi)}$$

Charm at Threshold

- $e^+e^- \rightarrow \Psi(3770) \rightarrow D\bar{D}$: Pure $J^{PC}=1^{--}$ initial state
 - Quantum correlations: For a correlated state with $C = -$

$$\Psi_- = \frac{1}{\sqrt{2}} (|D^0\rangle|\bar{D}^0\rangle - |\bar{D}^0\rangle|D^0\rangle)$$

One D and one \bar{D} at any time until one D decays

- Pure $D\bar{D}$ final state
- Low multiplicity $\sim 5-6$ charged
- More kinematical constraints

- **Single Tag**

- Reconstruct one D meson

- **Double Tag**

- Reconstruct both D and \bar{D}

- **Flavor Tag**

- **CP Tag**

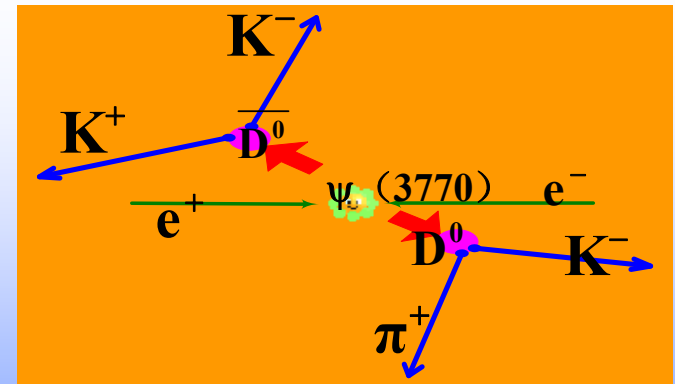

$\delta_{K\pi}$ @ BESIII

BESIII: *Largest data sample*
@charm threshold: 2.9fb^{-1} ($\sim 3.5 \times$
CLEO-c data) @ $\Psi(3770)$

- Reconstructed Modes

- Flavor tags: $K^-\pi^+$, $K^+\pi^-$
- CP+ tags (5 modes): K^+K^- , $\pi^+\pi^-$, $K_S\pi^0\pi^0$, $\pi^0\pi^0$, $\rho^0\pi^0$
- CP- tags (3 modes): $K_S\pi^0$, $K_S\eta$, $K_S\omega$

- Typical Kinematic variables:

Energy difference (ΔE) & Beam Constrained mass (M_{BC})

$$\Delta E = E_D - E_{\text{Beam}}$$

$$M_{BC} = \sqrt{E_{\text{Beam}}^2 - \vec{p}_D^2}$$

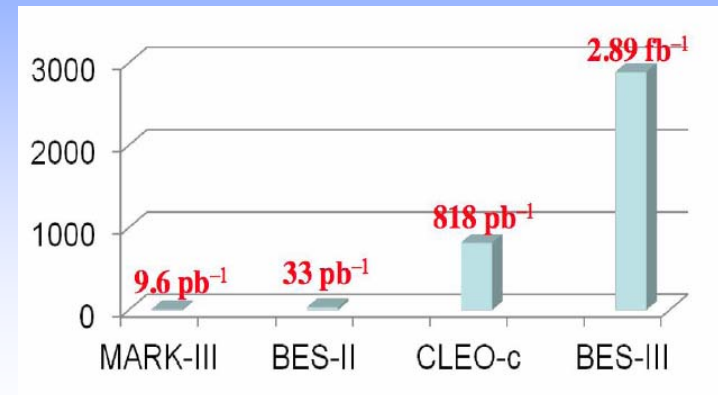

Signal Reconstruction

- **Signal Reconstruction:**
 - Single Tag (ST): CP tags
 - Double Tag (DT): $K\pi$ + CP Tag
 - Signal shape: $\sigma \otimes \text{MC-truth}$
 - Background shape: ARGUS function

- $$Br(D_{CP\pm} \rightarrow K\pi) = \frac{n_{K\pi,CP\pm}}{n_{CP\pm}} \cdot \frac{\epsilon_{CP\pm}}{\epsilon_{K\pi,CP\pm}}$$
 - Most systematic uncertainties cancelled for ratio $\epsilon_{CP}/\epsilon_{K\pi,CP}$

- **BESIII preliminary:**

$$A_{CP \rightarrow K\pi} = (12.77 \pm 1.31(\text{stat.})_{-0.31}^{+0.33}(\text{sys.}))\%$$

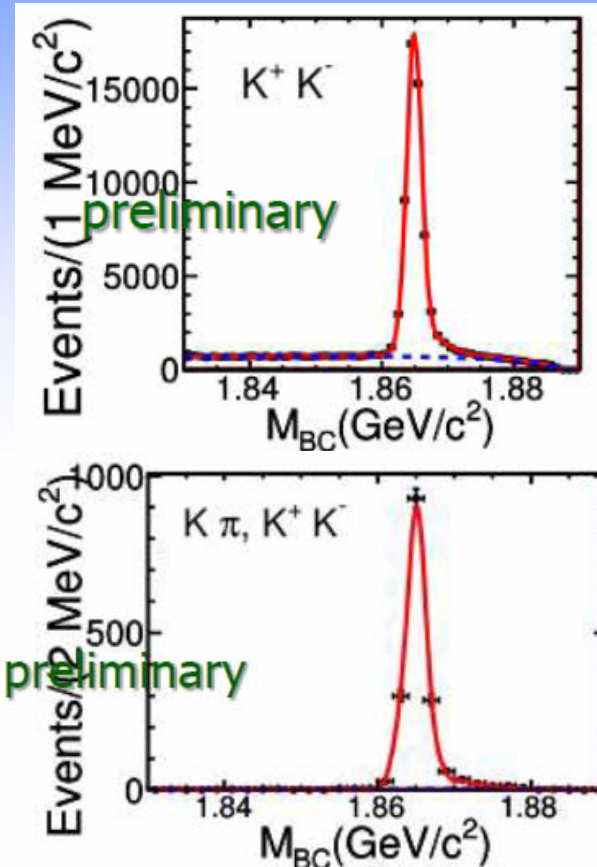

Result

- With external inputs from HFAG2013 and PDG

$$R_D = 3.47 \pm 0.06\%, \quad y = 6.6 \pm 0.9\% \quad R_{WS} = 3.80 \pm 0.05\%$$

- BESIII preliminary results:

$$\cos \delta_{K\pi} = 1.03 \pm 0.12 \pm 0.04 \pm 0.01$$

With 0.8fb^{-1} data at $\Psi(3770)$, CLEO-c measured:

without external inputs: $\cos \delta = 0.81_{-0.18-0.05}^{+0.22+0.07}$,

with external inputs: $\cos \delta = 1.15_{-0.17-0.08}^{+0.19+0.00}$

More details can be
obtained in the poster

BESIII result: the most precise measurement of $\delta_{K\pi}$ and compatible with the world average

Thank you!