

# Neutrino Physics

Zhi-zhong Xing  
(IHEP, Beijing)

## Lecture A:

Neutrino's history and lepton family

## Lecture B:

Neutrino masses and flavor mixing

## Lecture C:

Neutrino oscillation phenomenology

## Lecture D:

Selected topics on cosmic neutrinos

@ Weihai High Energy Physics School, 2—10/8/2015

# Neutrinos: how elusive they are?

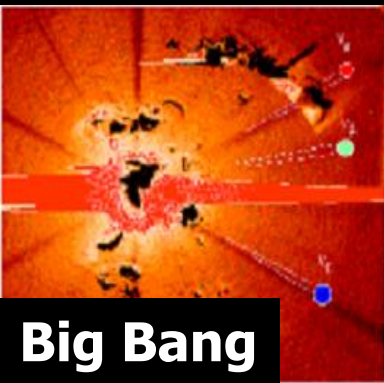

**Big Bang**

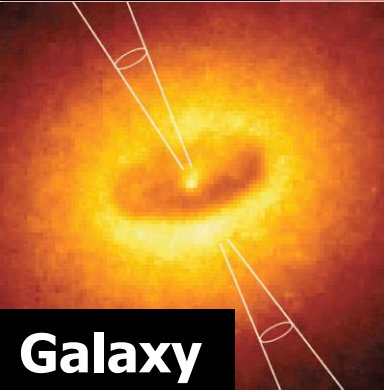

**Galaxy**



**Supernova**

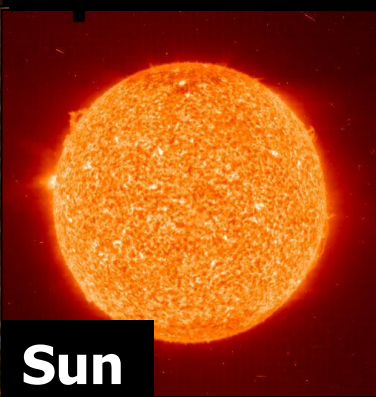

**Sun**



**Earth**

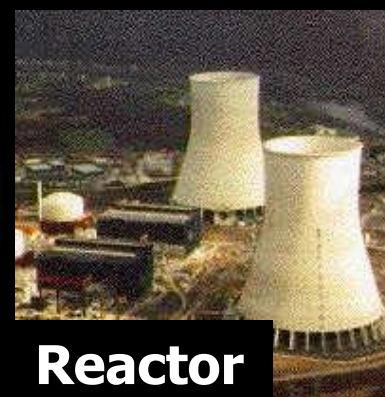

**Reactor**



**Accelerator**

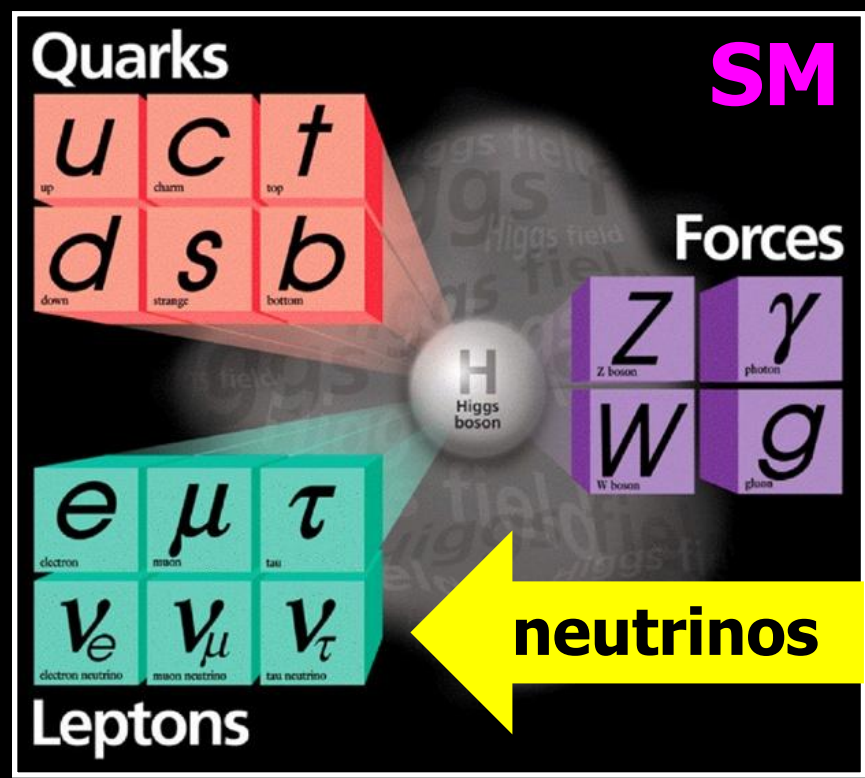

**charge = 0**  
**spin = 1/2**  
**mass = 0**  
**speed = c**

**Human Body**  
 $\Phi_\nu = 340 \times 10^6 \nu/\text{day}$

**Human**

# NEUTRINOS in the UNIVERSE

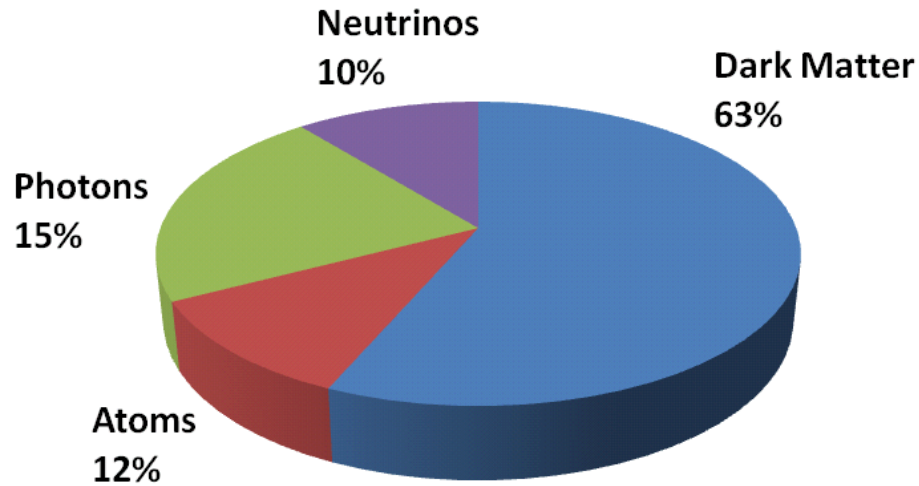

photon decoupling  
 $t = 380\,000$  years

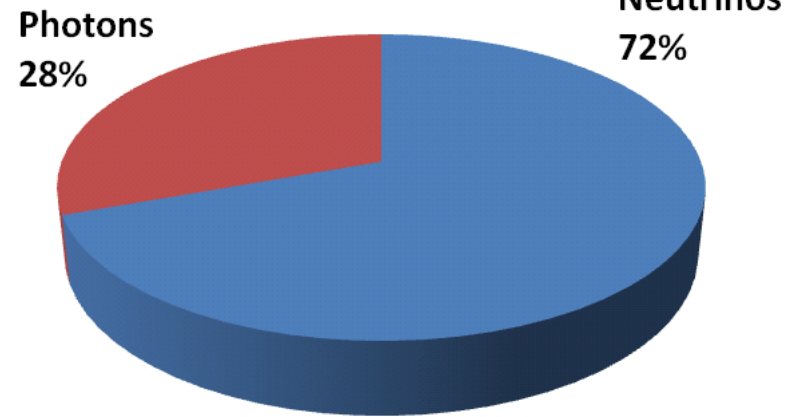

neutrino decoupling  
 $t = 1$  second

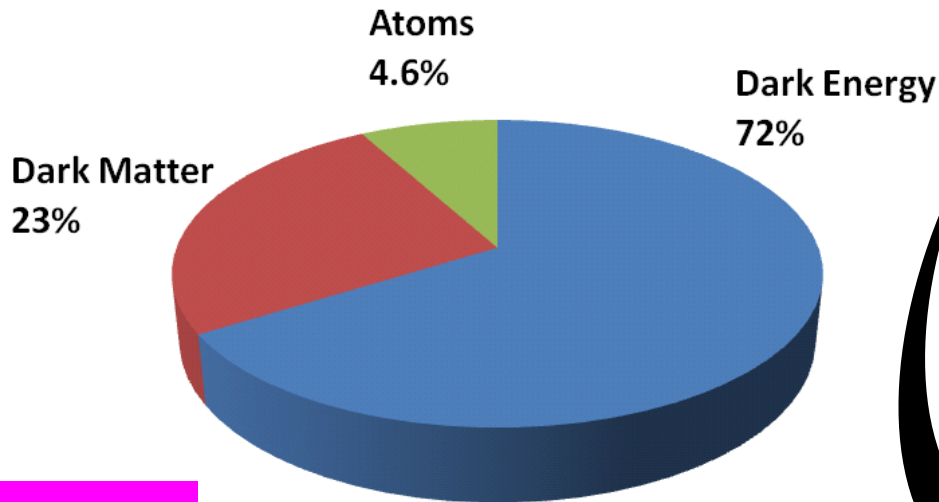

Today  
 $t = 13.7$  billion years

A very important role  
in the evolution of  
the Universe



# Open Questions

- the absolute  $\nu$  mass scale?
- how small is  $\theta_{13}$ ? (Daya Bay!)
- $\nu$  mass hierarchy? (JUNO?)
- CP violation? (MOMENT?)
- the Dirac/Majorana nature?
- the Majorana phases?
- how many species? ...
- cosmic  $\nu$  background?
- supernova & stellar  $\nu$ 's?
- Ultrahigh-energy cosmic  $\nu$ 's?
- warm dark matter?
- matter-antimatter asymmetry...

Monograph 2011 (426 pages)

ADVANCED TOPICS IN SCIENCE AND TECHNOLOGY IN CHINA

Zhizhong Xing  
Shun Zhou

## Neutrinos in Particle Physics, Astronomy and Cosmology



ZHEJIANG UNIVERSITY PRESS  
浙江大学出版社



Springer

# Lecture A

- ★ Neutrinos from new physics
- ★ Interactions and discoveries
- ★ Flavors / families of leptons



**Steven Weinberg (2003):** Learn something about the history of science, or at a minimum the history of your own branch of science.

The history of science can make your work seem more worthwhile to you.

You can get great satisfaction by recognizing that your work in science is a part of history.

# Beta decay in 1930

6

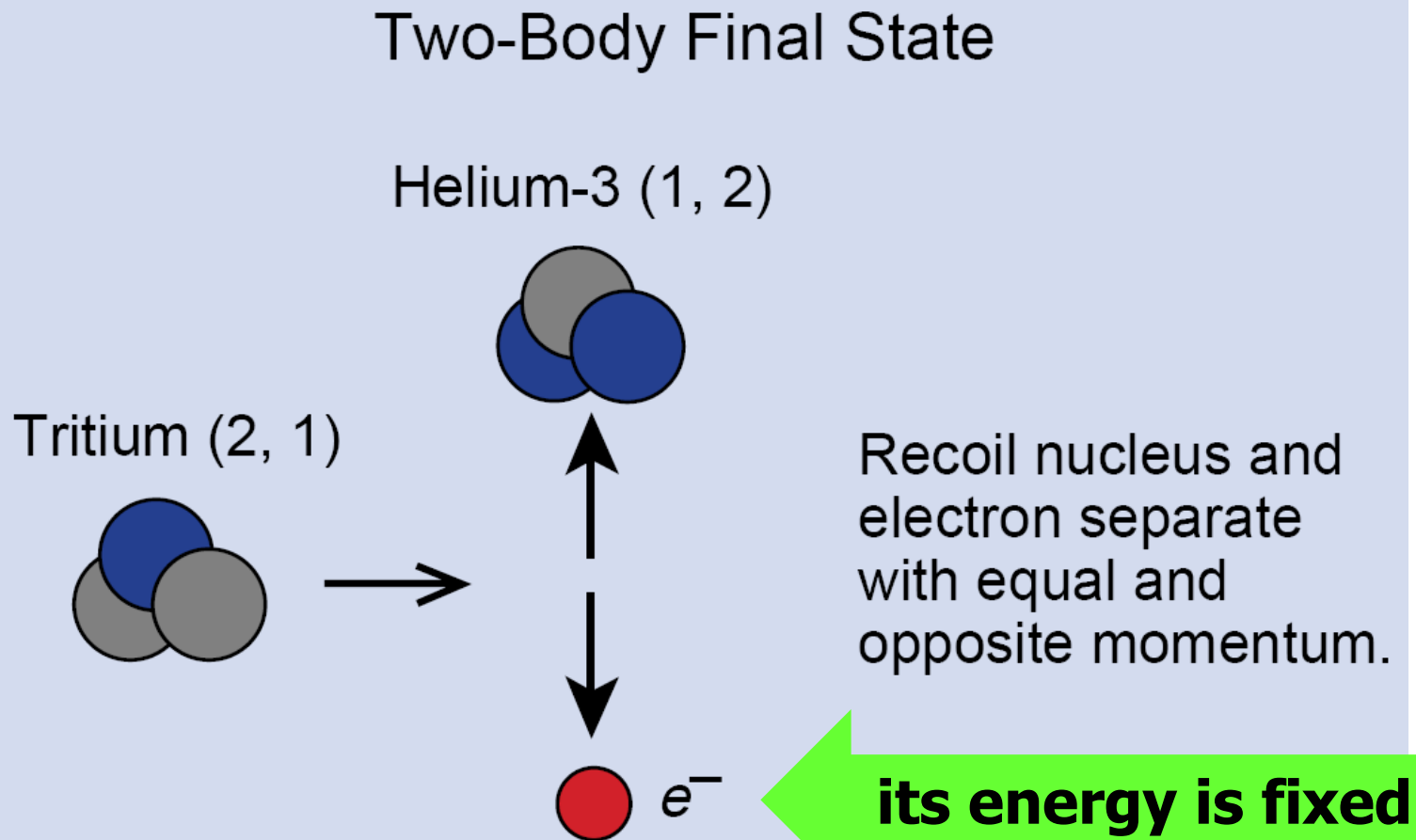

$$(N, Z) \rightarrow (N - 1, Z + 1) + e^{-},$$

where  $N$  = number of neutrons, and  
 $Z$  = number of protons.

# Energy crisis?

7

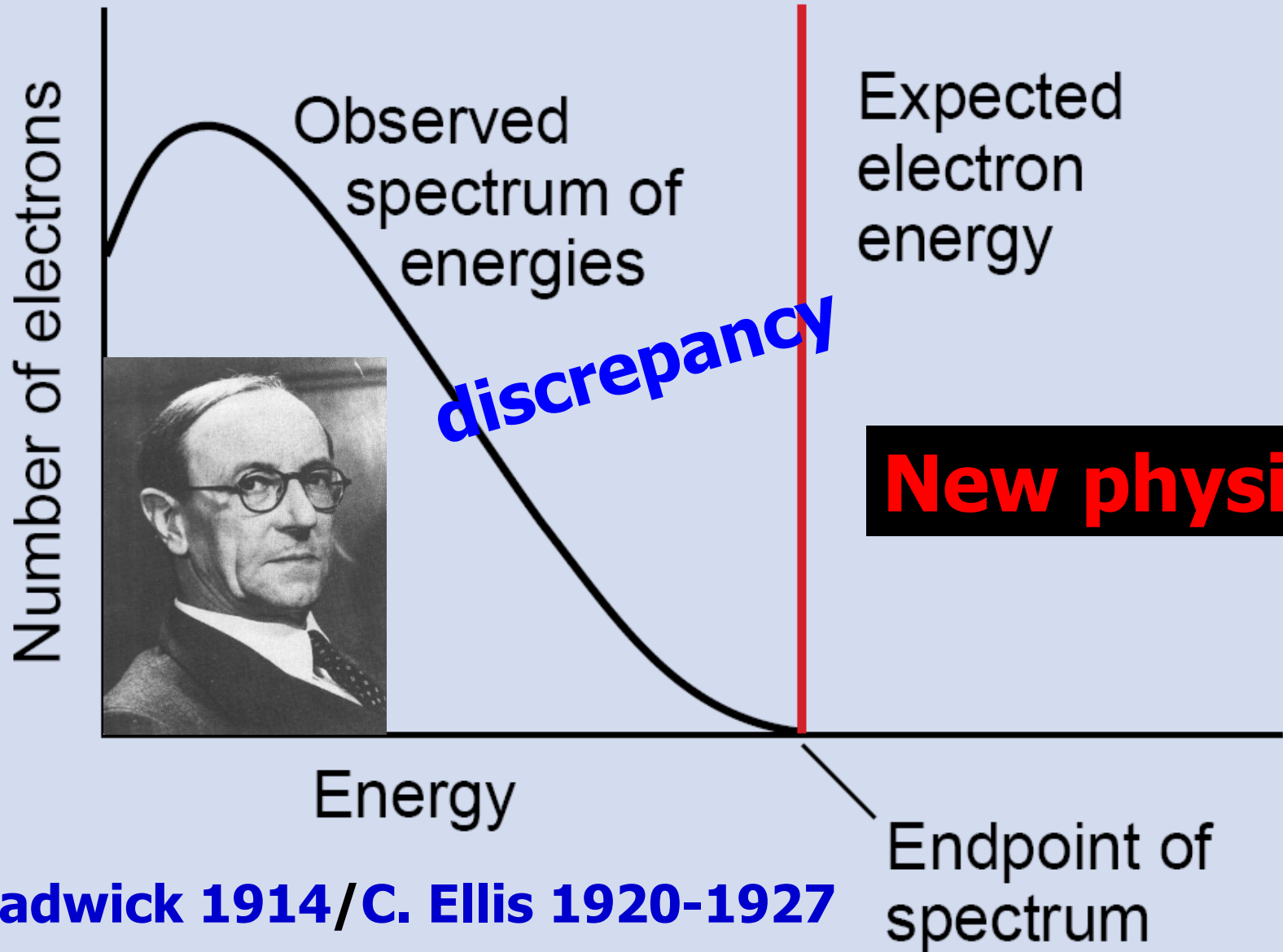

**New physics!**

**J. Chadwick 1914 / C. Ellis 1920-1927**

# Desperate remedy

8



**two viewpoints  
on new physics**

- ♣ giving up sth
- ♣ adding in sth

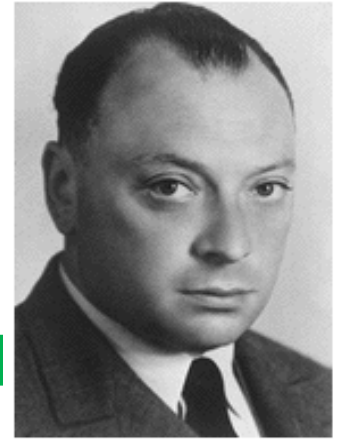

**Wolfgang Pauli (1930)**

## The Desperate Remedy

4 December 1930  
Gloriastr.  
Zürich

Physical Institute of the  
Federal Institute of Technology (ETH)  
Zürich  
Dear radioactive ladies and gentlemen,



# Pauli's letter

As the bearer of these lines, to whom I ask you to listen graciously, will explain more exactly, considering the 'false' statistics of N-14 and Li-6 nuclei, as well as the continuous  $\beta$ -spectrum, I have hit upon a desperate remedy to save the "exchange theorem"\* of statistics and the energy theorem. Namely [there is] the possibility that there could exist in the nuclei electrically neutral particles that I wish to call neutrons,\*\* which have spin 1/2 and obey the exclusion principle, and additionally differ from light quanta in that they do not travel with the velocity of light: The mass of the neutron must be of the same order of magnitude as the electron mass and, in any case, not larger than 0.01 proton mass. The continuous  $\beta$ -spectrum would then become understandable by the assumption that in  $\beta$  decay a neutron is emitted together with the electron, in such a way that the sum of the energies of neutron and electron is constant.

But I don't feel secure enough to publish anything about this idea, so I first turn confidently to you, dear radioactives, with a question as to the situation concerning experimental proof of such a neutron, if it has something like about 10 times the penetrating capacity of a  $\gamma$  ray.

I admit that my remedy may appear to have a small *a priori* probability because neutrons, if they exist, would probably have long ago been seen. However, only those who wager can win, and the seriousness of the situation of the continuous  $\beta$ -spectrum can be made clear by the saying of my honored predecessor in office, Mr. Debye, who told me a short while ago in Brussels, "One does best not to think about that at all, like the new taxes." Thus one should earnestly discuss every way of salvation.—So, dear radioactives, put it to test and set it right.—Unfortunately, I cannot personally appear in Tübingen, since I am indispensable here on account of a ball taking place in Zürich in the night from 6 to 7 of December.—With many greetings to you, also to Mr. Back, your devoted servant,

W. Pauli

# Pauli's picture of $\beta$ decay

11

Three-Body Final State

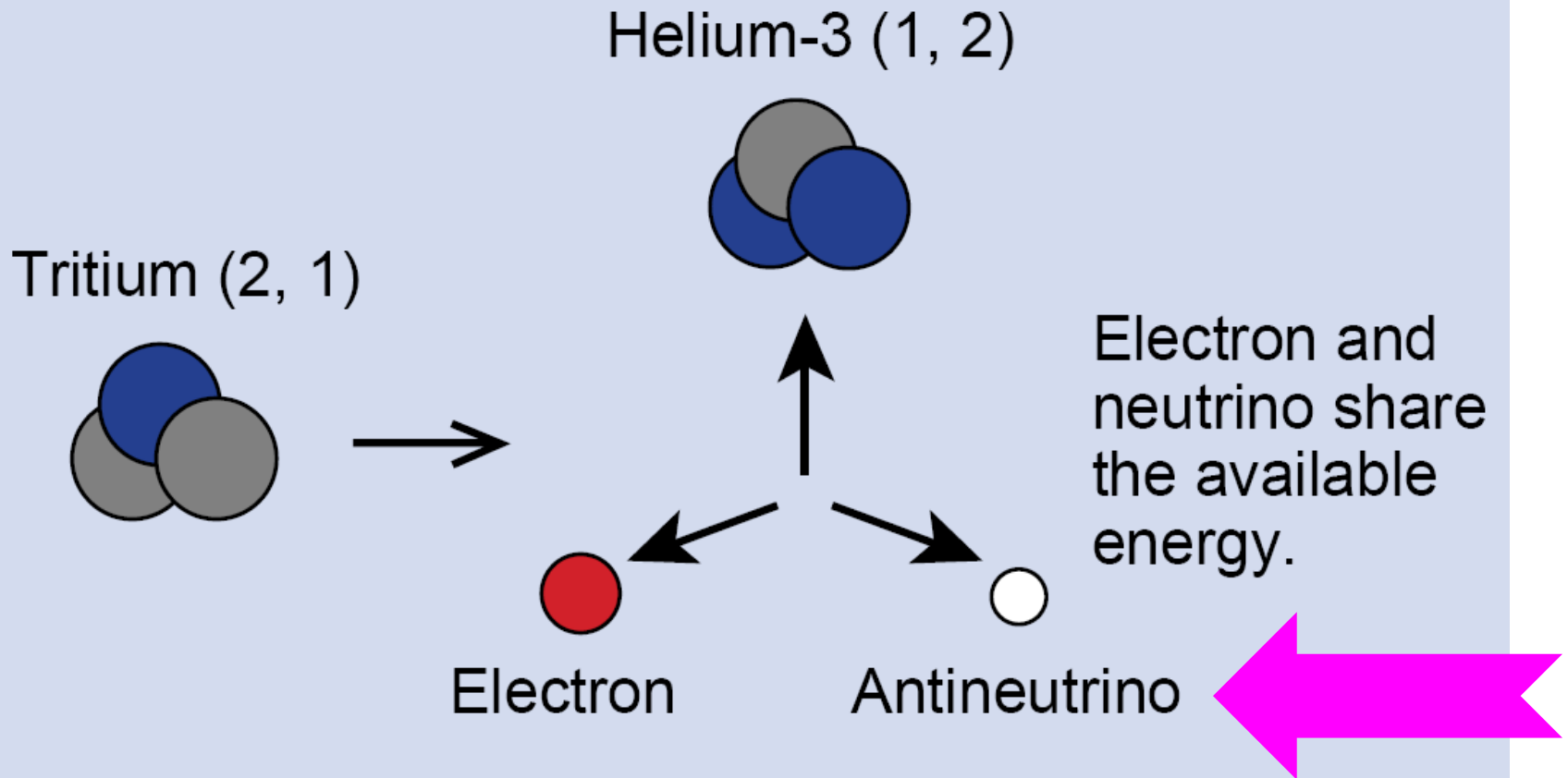

$$(N, Z) \rightarrow (N - 1, Z + 1) + e^{-} + \bar{\nu} .$$

# Solvay 1933

12

Pauli gave a talk on his **neutrino** proposal in this congress.

INSTITUT INTERNATIONAL DE PHYSIQUE SOLVAY  
SEPTIÈME CONSEIL DE PHYSIQUE -- BRUXELLES, 22-29 OCTOBRE 1933

22 – 29 Octobre 1933

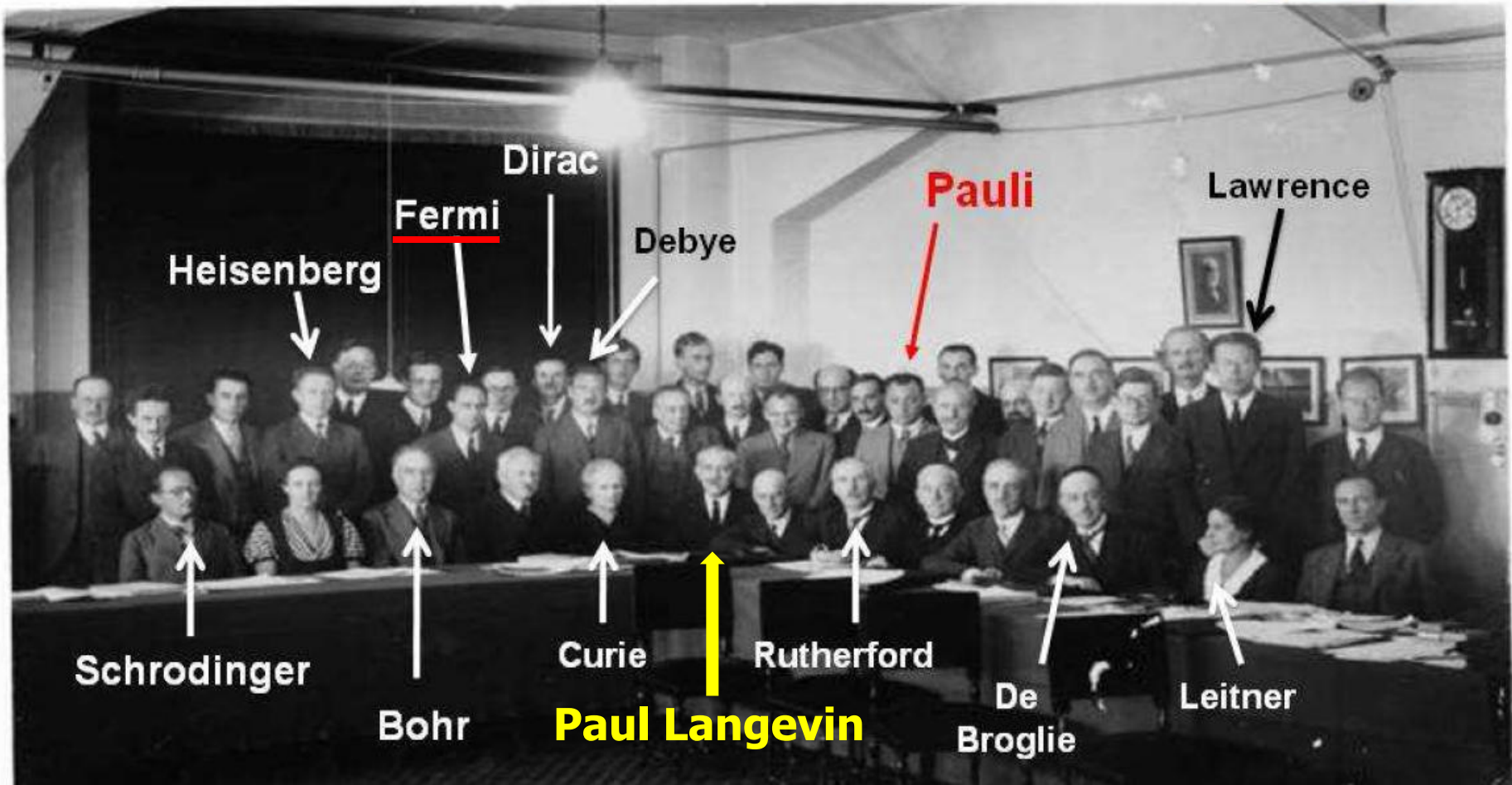

# Fermi's theory

13

Enrico Fermi assumed a new force for  $\beta$  decay by combining 3 brand-new concepts:

★ Pauli's hypothesis: neutrinos

★ Dirac's thought: creation of particles

★ Heisenberg's idea: neutron is related to proton

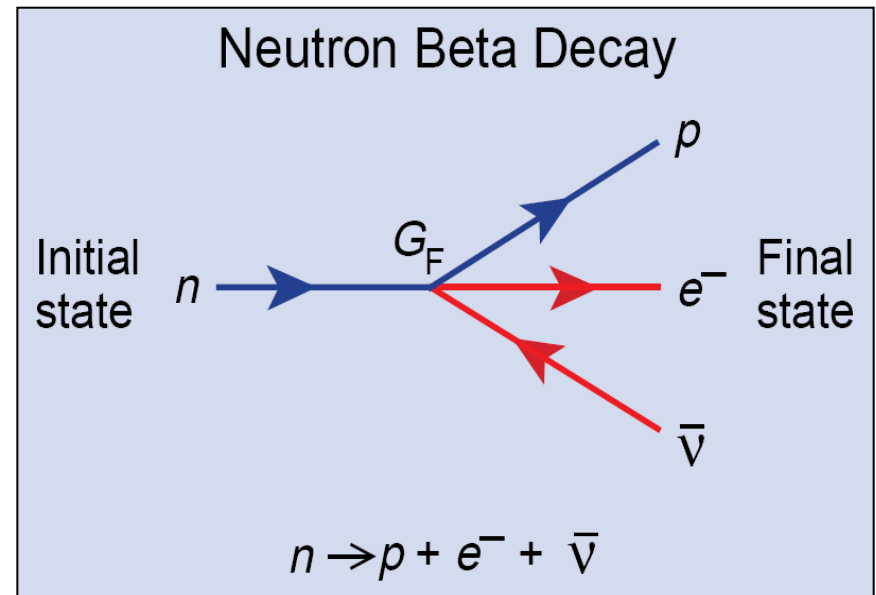
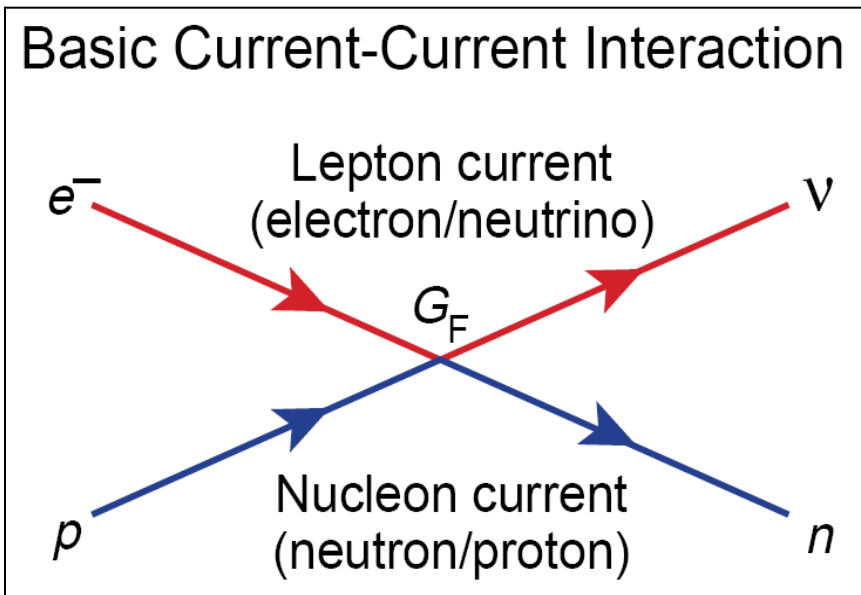

# Fermi's paper

14

## E. Fermi's publications on the Weak Interaction

**REJECTED**

E. Fermi, "Tentative Theory of Beta Rays"  
Letter Submitted to Nature (1933)

31 Dec, 1933



**This is Fermi's best theoretical work  
---- C.N. Yang**

**"I will be remembered  
for this paper!"**

**----- Fermi in Italian  
Alps, Christmas 1933**

**Published first in this journal and later in Z. Phys. in 1934.**

# Weak interactions

15

From Fermi's current-current interaction to weak charged-current gauge interactions.

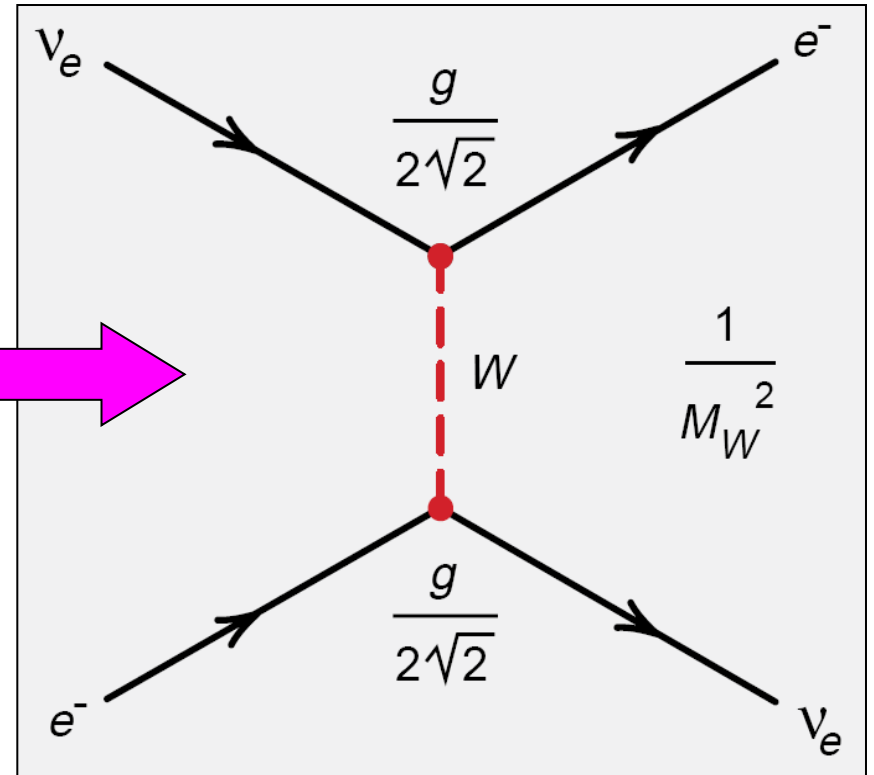
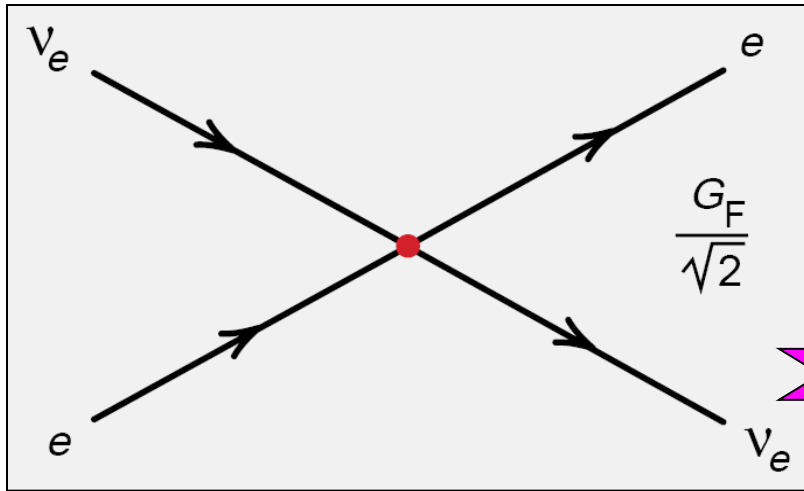

$$\frac{G_F}{\sqrt{2}} = \frac{g^2}{8M_W^2}$$



$$M_W = 80.4 \text{ GeV}$$

$$G_F = 1.66 \times 10^{-5} \text{ GeV}^{-2}$$

# Typical processes

16

## Electron-neutrino scattering

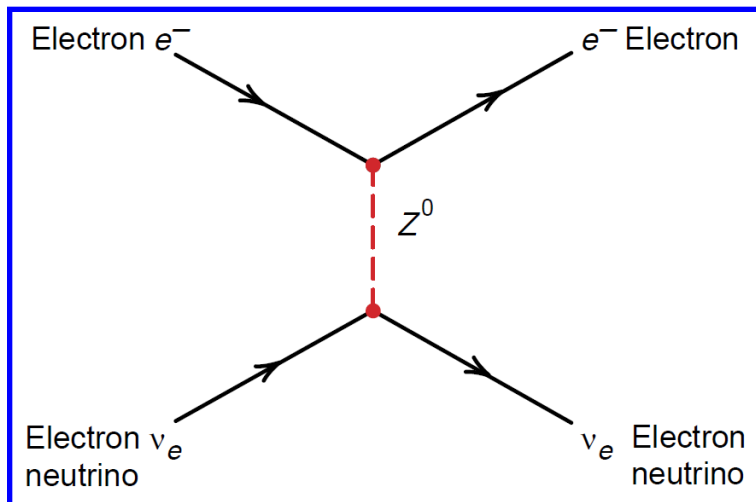
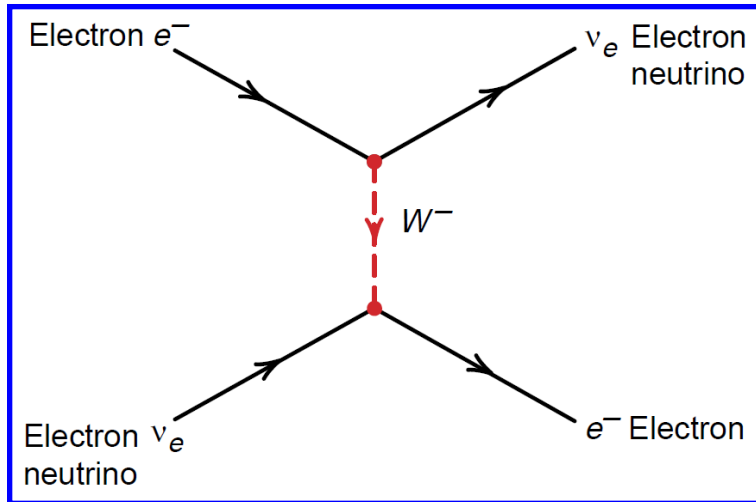

## Neutron $\beta$ decay / inverse $\beta$ decay

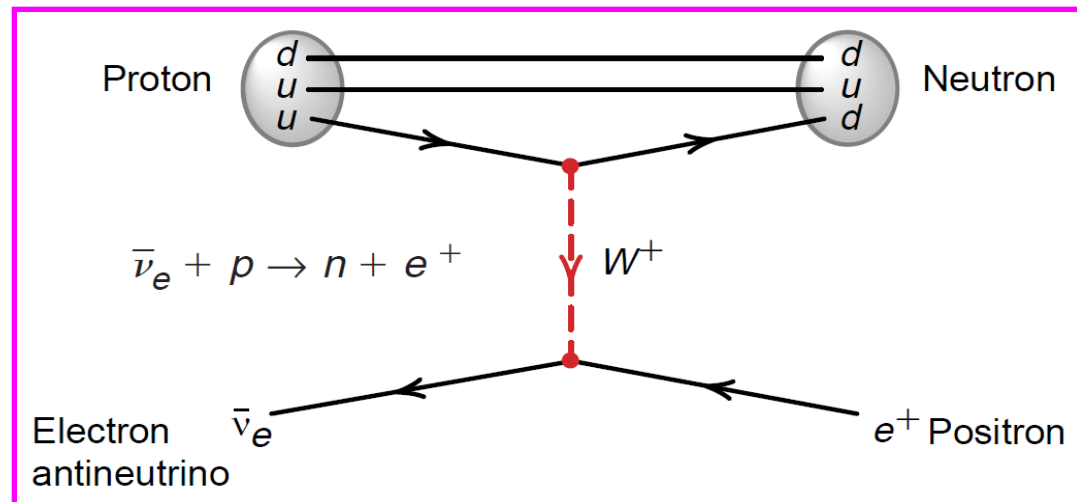
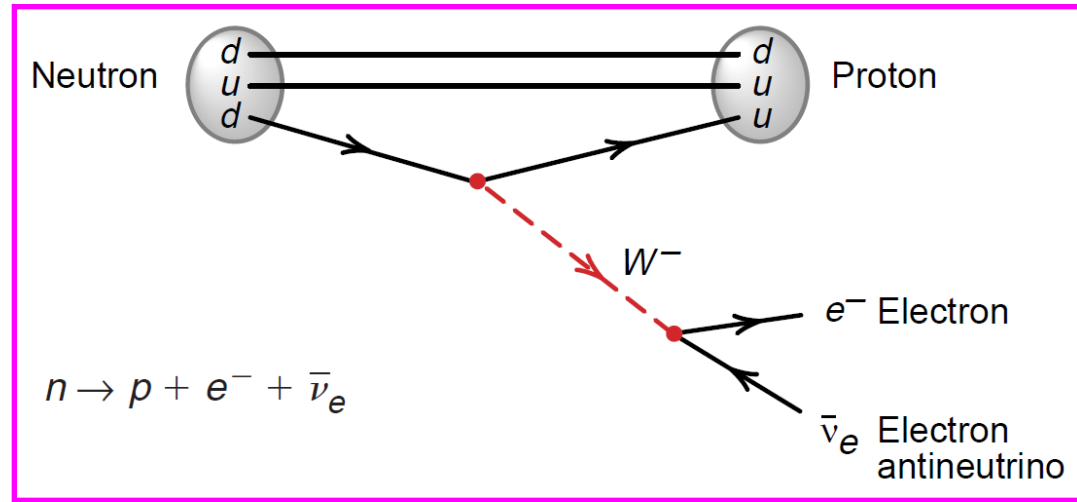

**Exercise:** draw an electron-antineutrino scattering Feynman diagram.



# Why the sun shines?

17

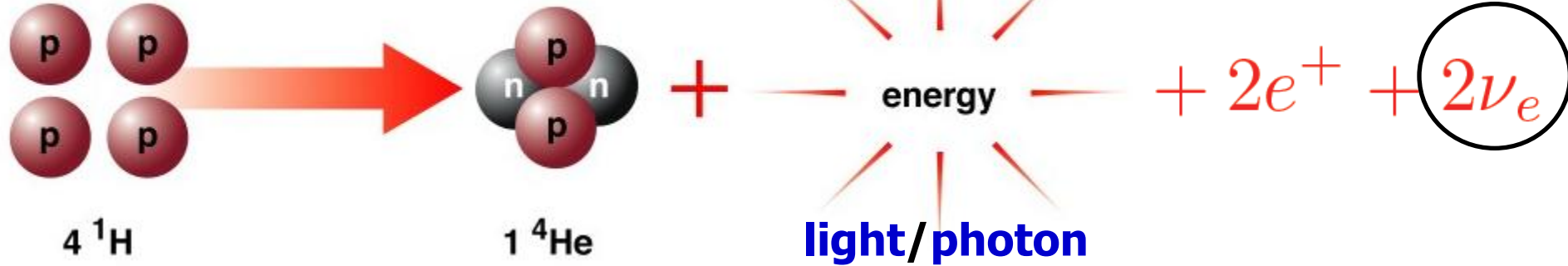
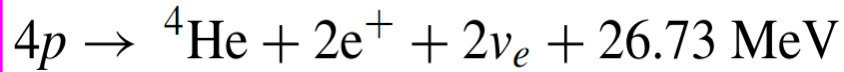

**Hans Bethe (1939), George Gamow & Mario Schoenberg (1940, 1941)**

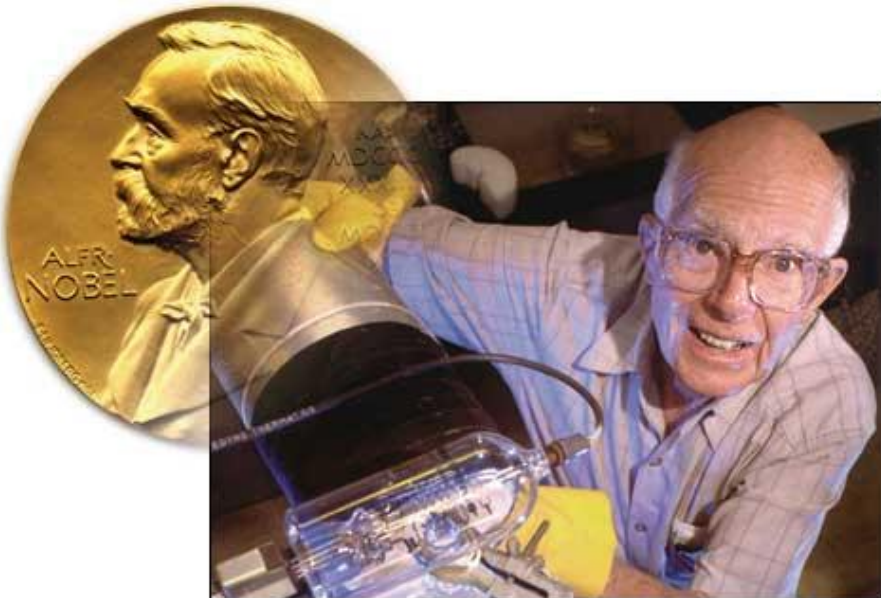

**Raymond Davis: born in 1914, discovery in 1968 and Nobel Prize in 2002**

**Observed the solar neutrino and its anomaly in 1968**

# Too shy to be seen?

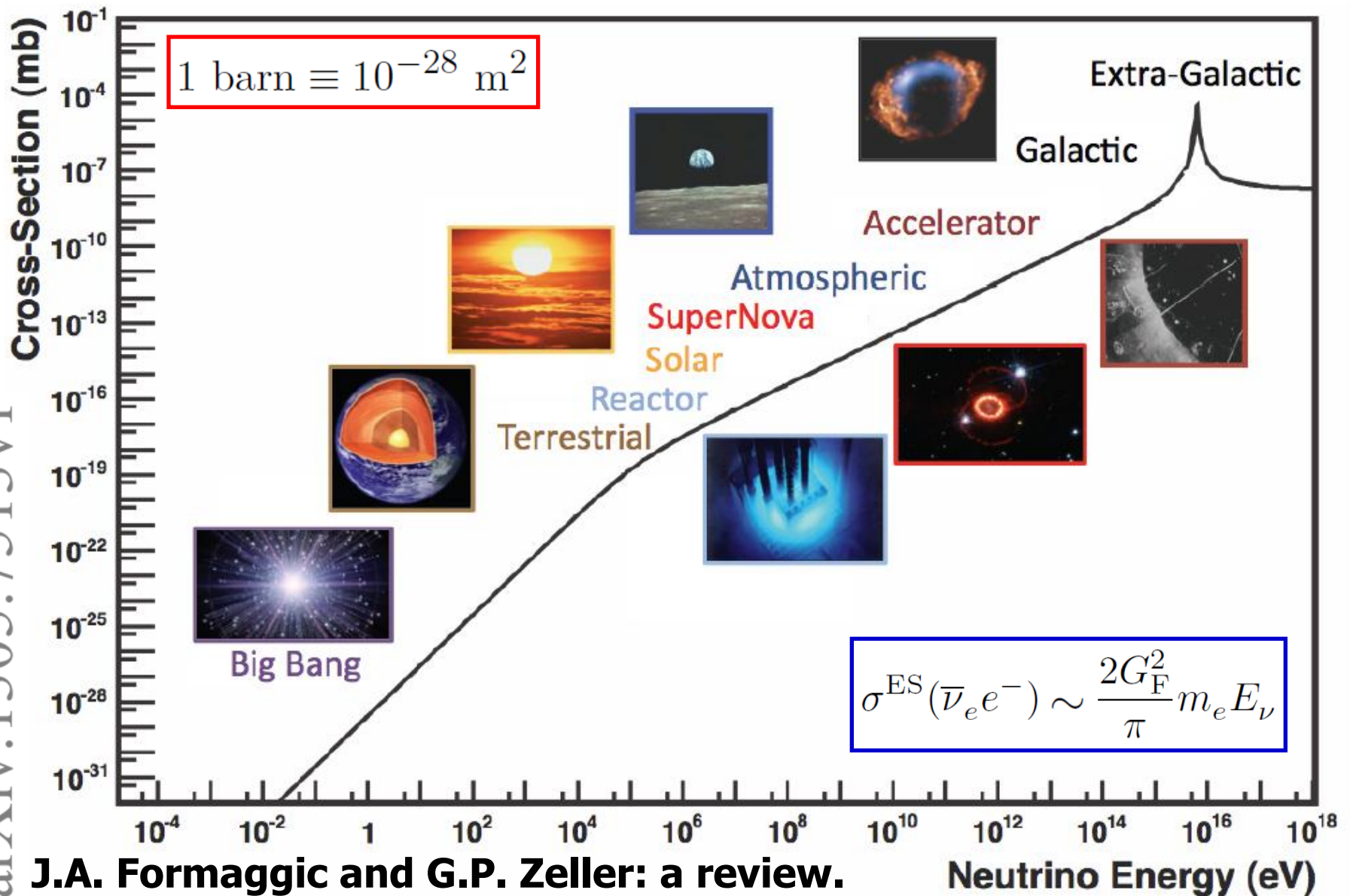

arXiv:1305.7513v1

# Impossible challenge

19

An inverse  $\beta$  decay to detect neutrinos (Hans Bethe 1936)

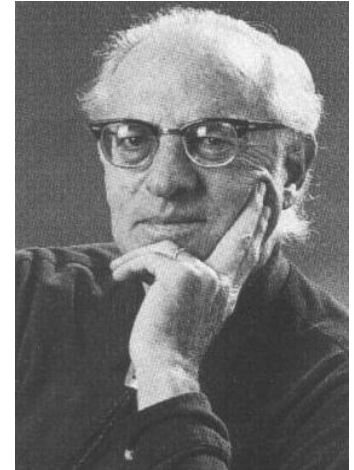
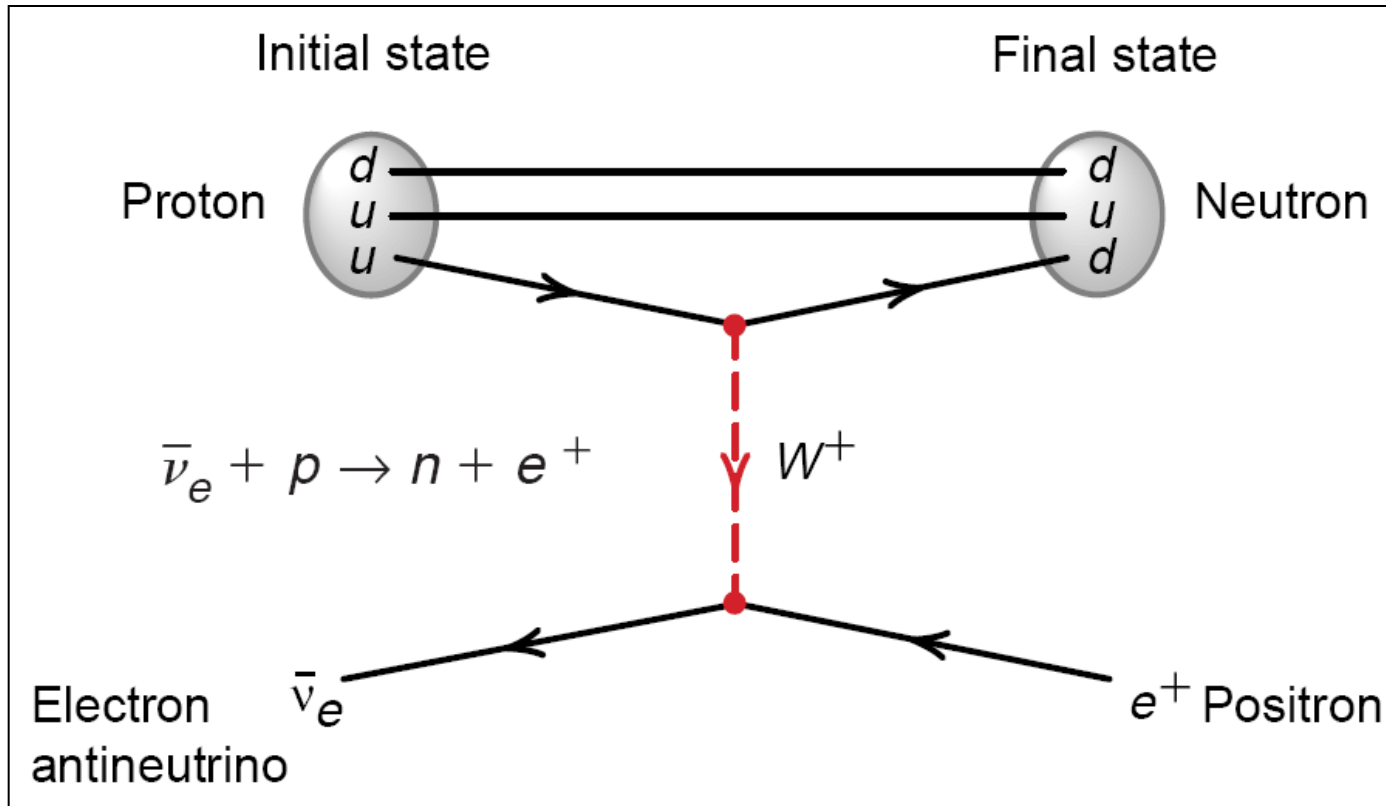

Very intense sources of neutrinos (1950's):  
**fission bombs** and **fission reactors**.

**Frederick Reines & Clyde Cowan's Project (1951).**

# Reactor antineutrinos

20

Decision in 1952: neutrinos from a fission reactor.

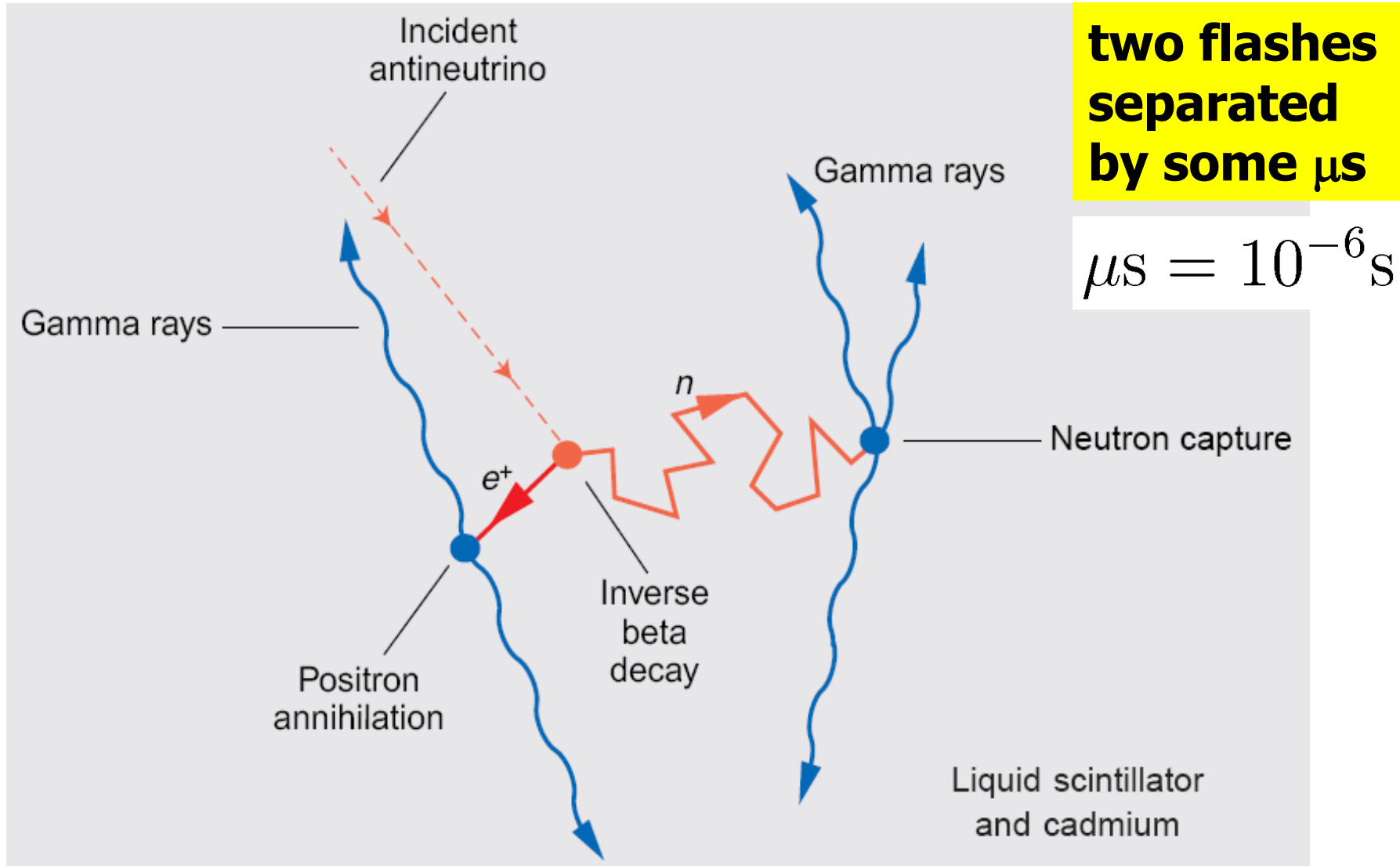

# Positive result?

21

Reines and Cowan's telegram to Pauli on 14/06/1956:

We're happy to inform you that we've definitely detected neutrinos from fission fragments by observing inverse  $\beta$  decay of protons. Observed cross section agrees well with expected  $6 \times 10^{-44} \text{ cm}^2$ . (Pauli didn't reply, a case of champagne)

Such a theoretical value was based on a **parity-conserving** formulation of the  $\beta$  decay with **4** independent degrees of freedom for  **$\nu$ 's**.

$$\sigma(\bar{\nu}_e p) = \sigma(\nu_e n) \approx 9.1 \times 10^{-44} \left( \frac{E_\nu}{\text{MeV}} \right)^2 \text{ cm}^2$$

This value is at least **doubled** after the discovery of **parity violation** in 1957, leading to the two-component neutrino theory in 1957 and the **V-A** weak theory in 1958.

# Neutrinos in 1957

22

The neutrino should have no mass: 2-component  $\nu$  theory

★ **Abdus Salam**

received 15/11/1956,  
Nuovo Cim. 5 (1957) 299

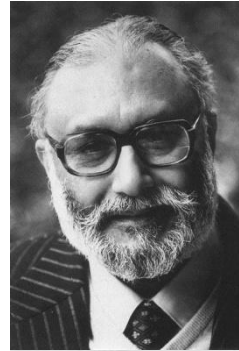

★ **Lev Landau**

received 9/1/1957,  
Nucl. Phys. 3 (1957) 127

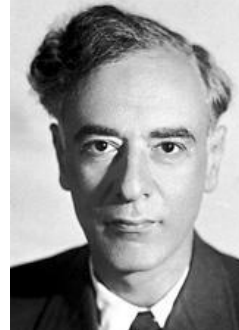

★ **T.D. Lee, C.N. Yang**

received 10/1/1957,  
Phys. Rev. 105 (1957) 1671

**Bruno Pontecorvo challenged the massless  $\nu$  theory in 1957**

**John Ward** wrote to **Salam**:

So many congratulations and fond hopes for at least one-third of a Nobel Prize.

———— **Norman Bombey** in “Abdus Salam: How to Win the Nobel Prize”, Preprint arXiv:1109.1972 (9/2011).



# Nobel Prize

23

A new paper on this experiment published in Phys. Rev. in 1960 reported a cross section **twice** as large as that given in 1956.

Reines (1979): our initial analysis grossly overestimated the detection efficiency with the result that the measured cross section was at first thought to be in good agreement with [the pre-parity violation] prediction.



**Skepticism**  
{over 39 years}

The **Nobel Prize** finally came to Frederick Reines in 1995!

# Pontecorvo's idea

24

## ★ Theory of the Symmetry of Electrons and Positrons

Ettore Majorana

*Nuovo Cim. 14 (1937) 171*

Are massive **neutrinos** and **antineutrinos** identical or different — a fundamental puzzling question in particle physics.



## ★ Mesonium and Anti-mesonium

Bruno Pontecorvo

*Zh. Eksp. Teor. Fiz. 33 (1957) 549*

*Sov. Phys. JETP 6 (1957) 429*

If the two-component neutrino theory turned out to be incorrect and if the conservation law of neutrino charge didn't apply, then **neutrino-antineutrino** transitions would in principle be possible to take place in vacuum.

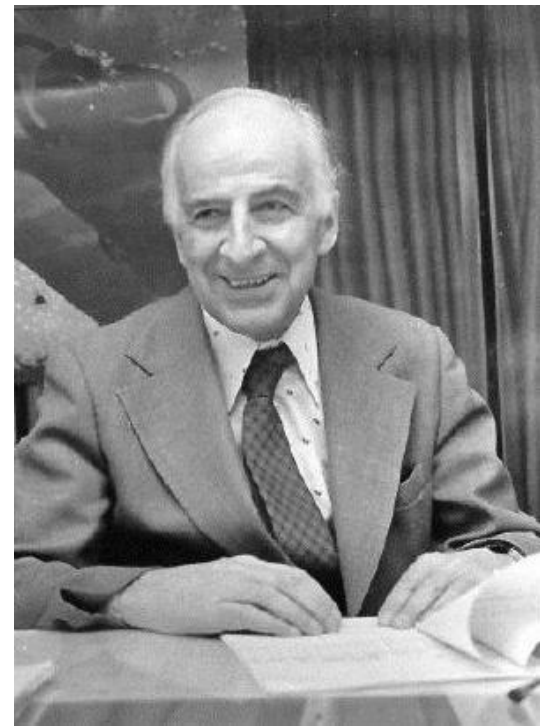



# $0\nu\beta\beta$

The neutrinoless double beta decay can happen if massive neutrinos are the Majorana particles:

Initial state

$$N(n, p)$$

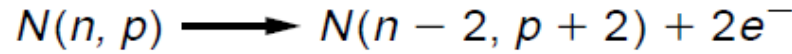

Final state

$$N(n - 2, p + 2)$$

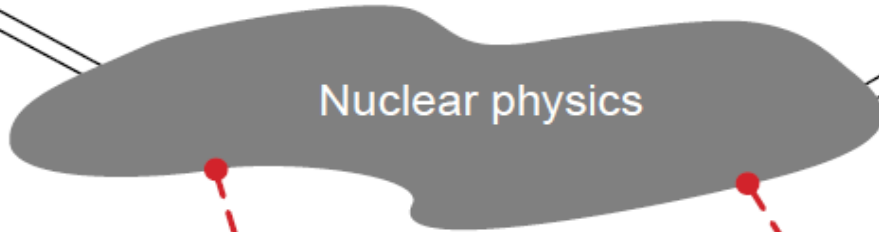

Lepton number violation  $\rightarrow$

CP-conserving process  $\leftarrow$

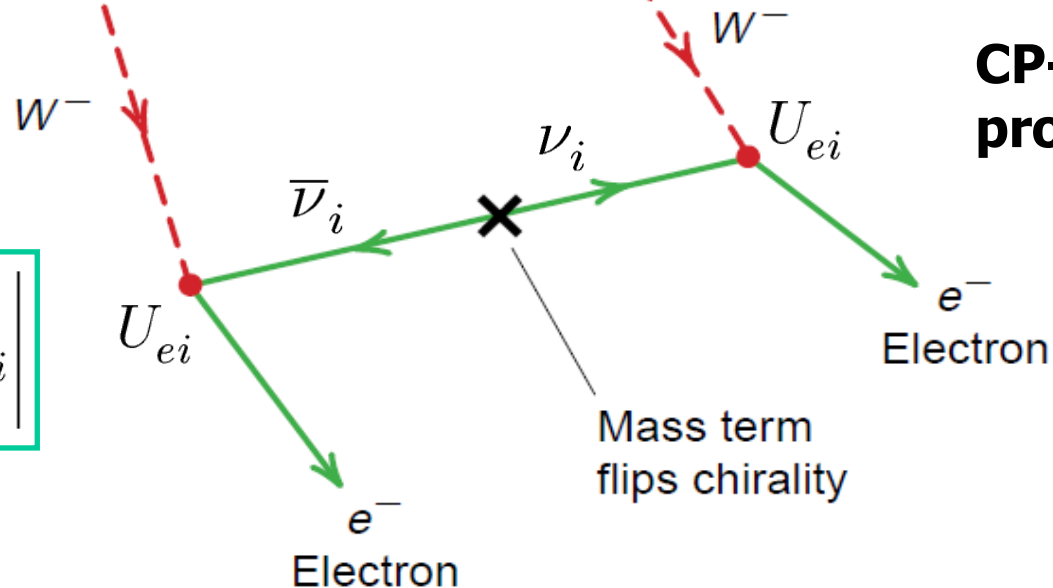

$$|\langle m \rangle_{ee}| = \left| \sum_i m_i U_{ei}^2 \right|$$

# Parity and Helicity

**Parity and Helicity:** if parity were conserved, a spin-1/2 particle would exist in both left- & right-helicity states.

(b) Mirror Reflection of a Right-Helicity Particle

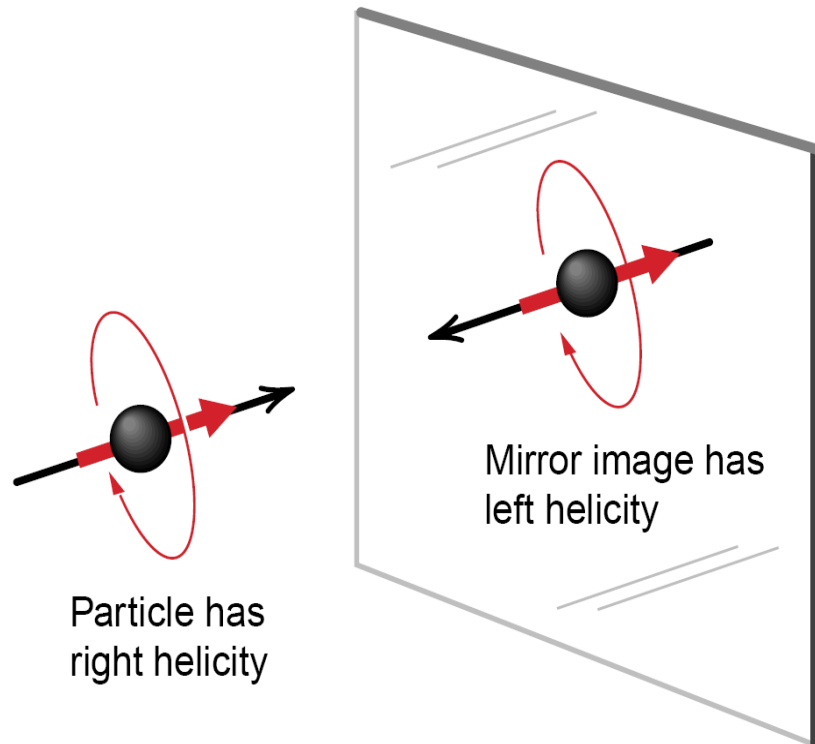

(a) Four States of a Spin-1/2 Particle

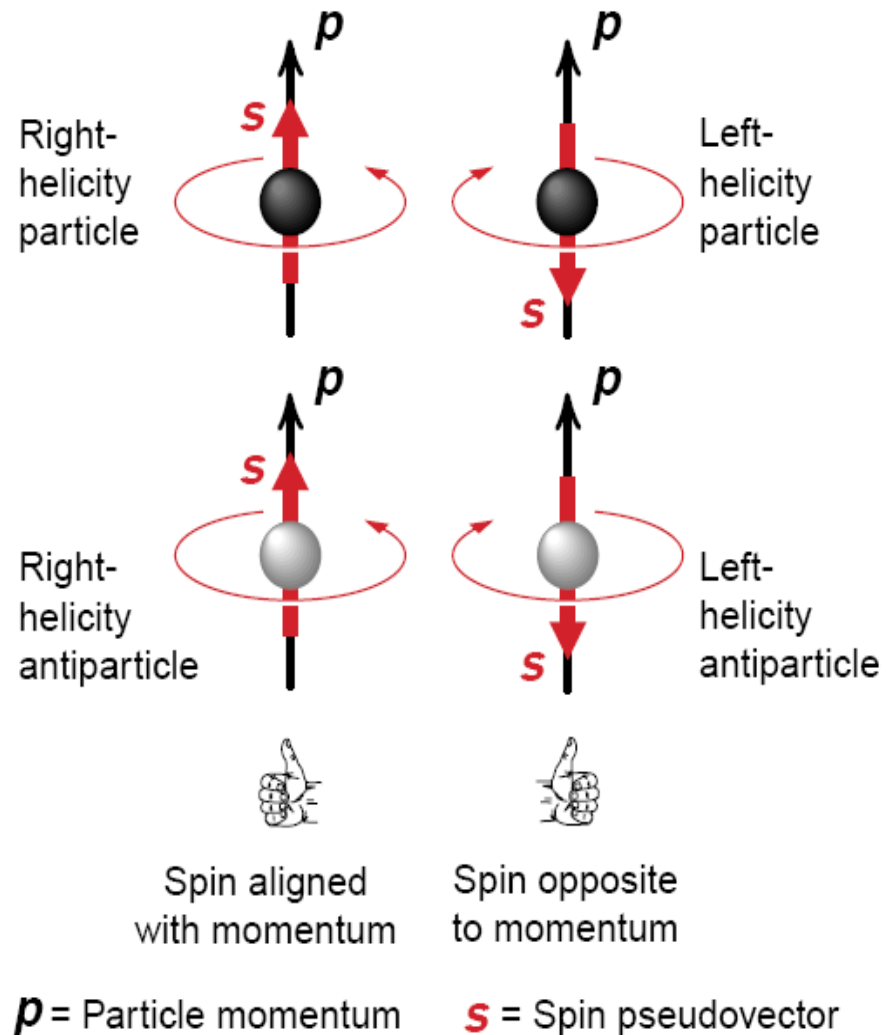

# Wu's Experiment



C.S. Wu aligned the spins of Cobalt-60 nuclei along an external magnetic field and then measured the directions of the electrons emitted by those nuclei. She observed **maximal parity violation!**

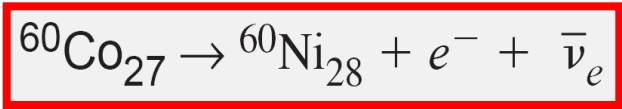

Lee & Yang's two-component neutrino theory explained the data but implied: **neutrinos are left-handed & massless!**

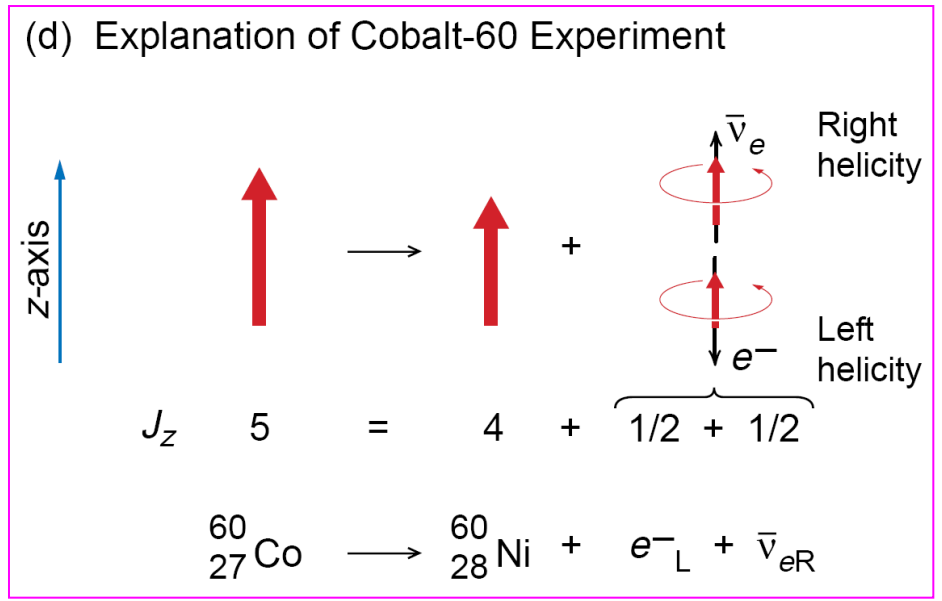
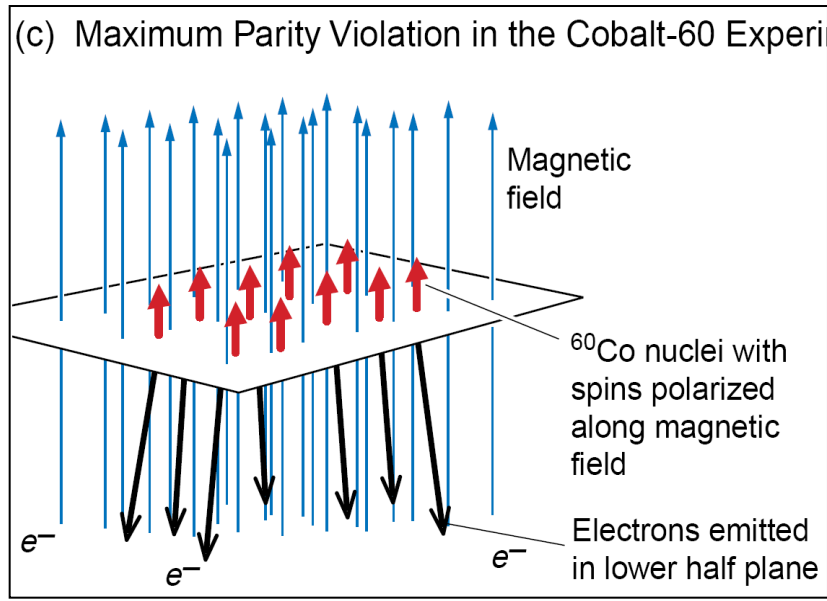

在1957年1月4日的星期五午餐会上，李政道向他的同事们透露了这一令人振奋的实验结果。莱德曼（Leon Lederman）意识到问题的重要性，当晚就打电话给他的合作者加尔文（Richard Garwin），建议利用哥伦比亚大学的回旋加速器所产生的极化 $\mu$ 子做实验，从另一种途径检验弱相互作用中的宇称不守恒。他们连夜行动起来，四天之内就得到了可靠的实验数据，并写出了论文的初稿。李政道得知这一消息后，劝阻莱德曼等人不要马上投稿，否则对吴健雄的团队来说是不公平的，因为后者已经辛苦地工作了好几个月，而且率先得到了实验证据。1月15日，哥伦比亚大学举行了记者招待会，吴健雄和莱德曼两个团队分别报告了他们的重大科学发现：宇称在弱相互作用中的确是不守恒的！他们在记者招待会的当天将各自的论文投到了《物理评论》（Physical Review）。半个月之后，两篇论文并列发表出来；同一年的年底，李政道和杨振宁荣获了诺贝尔物理学奖。



# 论文 比肩 的背后？

# Helicity

29

The **Helicity** of a fermion relates its spin to its direction of motion

$$\lambda = \mathbf{s} \cdot \mathbf{p} / |\mathbf{p}| = \pm 1/2$$

A massive particle's **helicity** isn't relativistically invariant.

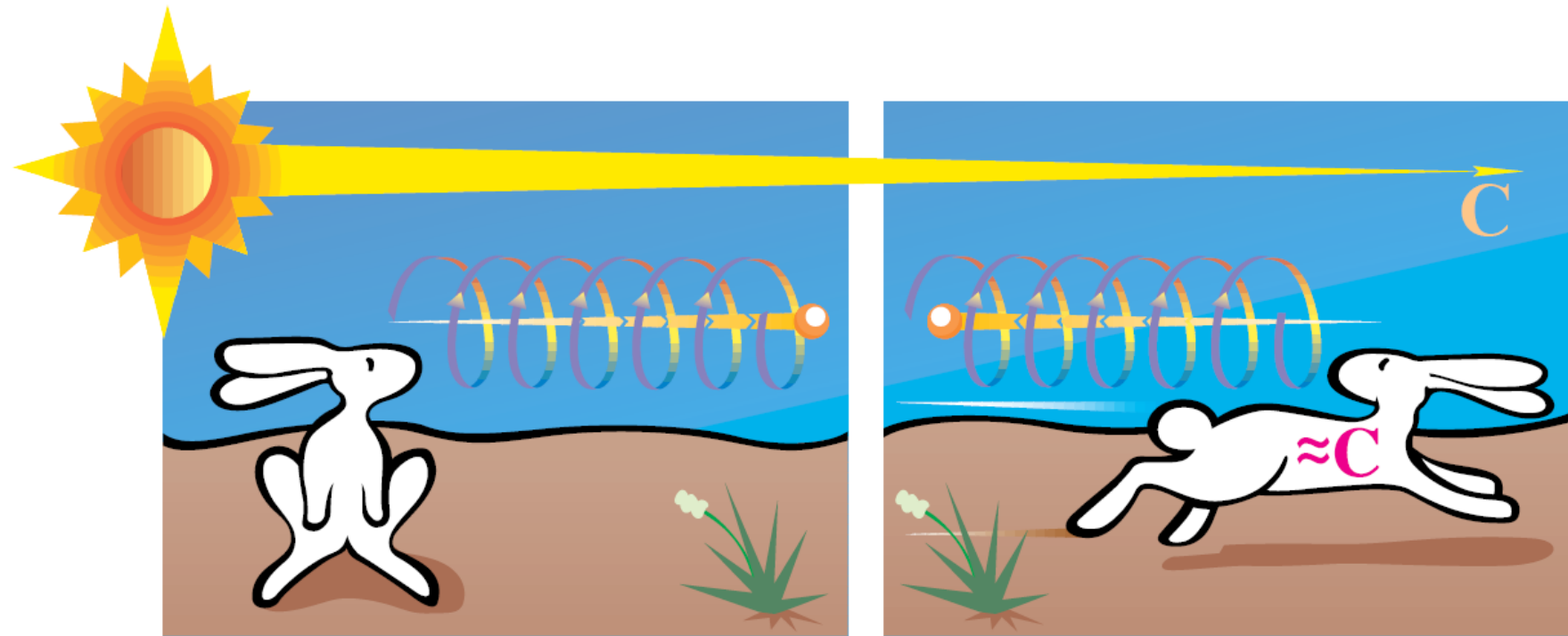

Looks like a left-handed corkscrew.

No—like a right-handed corkscrew!

# Left-handed

A proof of the **negative helicity** of a neutrino was done in 1958.

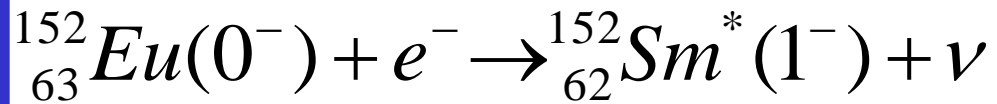

$$\lambda = \mathbf{s} \cdot \mathbf{p} / |\mathbf{p}| = \pm 1/2$$

In this reaction, the  $\text{Sm}^*$  nucleus recoils from the neutrino. It decays into the ground state simply by emitting a  $\gamma$  particle. Then the polarization of this  $\gamma$  particle measures the **neutrino's helicity** in a rather non-trivial way.

$$\lambda = -1/2$$



## Helicity of Neutrinos\*

M. GOLDHABER, L. GRODZINS, AND A. W. SUNYAR

*Brookhaven National Laboratory, Upton, New York*

(Received December 11, 1957)

A COMBINED analysis of circular polarization and resonant scattering of  $\gamma$  rays following orbital electron capture measures the helicity of the neutrino. We have carried out such a measurement with  $\text{Eu}^{152m}$ , which decays by orbital electron capture. If we assume the most plausible spin-parity assignment for this isomer compatible with its decay scheme,<sup>1</sup>  $0^-$ , we find that the neutrino is “left-handed,” i.e.,  $\boldsymbol{\sigma}_\nu \cdot \hat{\mathbf{p}}_\nu = -1$  (negative helicity).

# Handedness

The **Handedness** of a spin-1/2 particle is a relativistically invariant quantity to describe this particle's spin states.

2 independent handedness or **chirality** states: **left** & **right**.

A massless or massive particle can always be decomposed into two independent components: **left-** and **right-handed**.

$$\psi = \psi_L + \psi_R$$

$$\psi_L = \frac{1 + \gamma_5}{2} \psi$$

$$\psi_R = \frac{1 - \gamma_5}{2} \psi$$

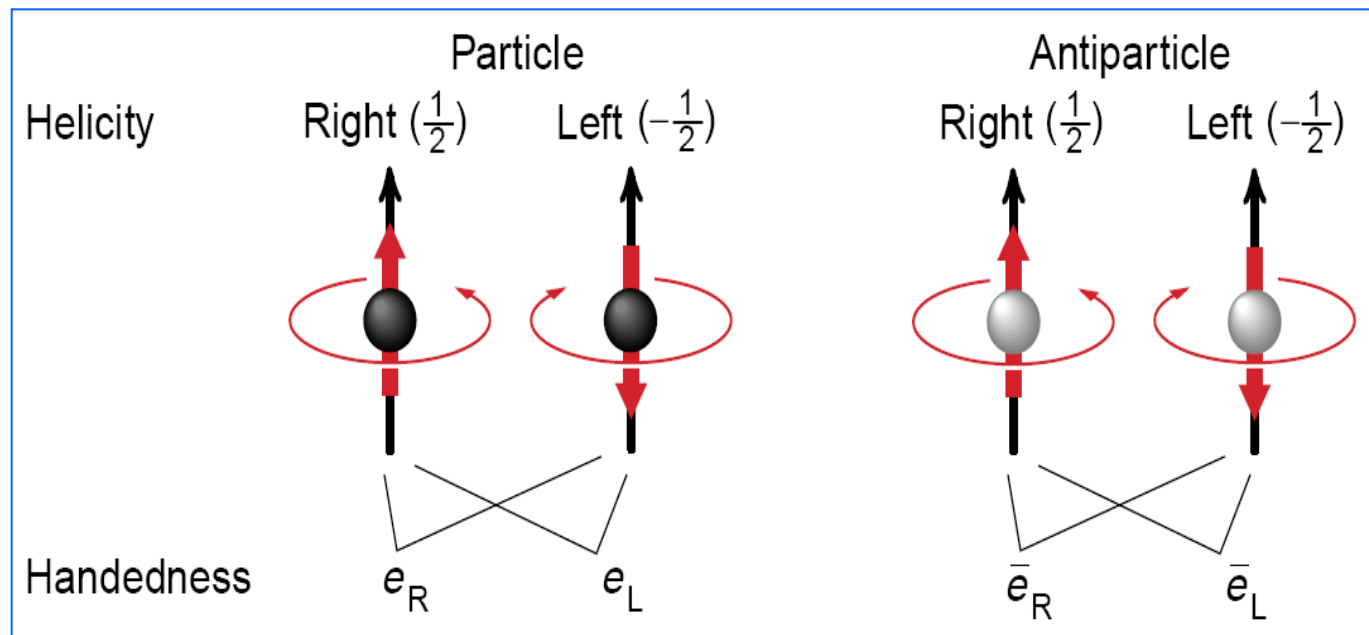

# Weak states

The **Handedness** is an essential quantity for describing the weak force (see the table for the 1st-family in the SM).

For example:

The right-handed electron is a weak isospin singlet: it does not interact with the **W** boson, but it does couple to the photon and to the **Z** boson.

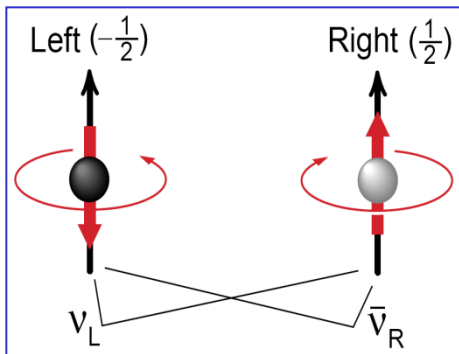

Particle Number $N$	Handedness $N_x$	Particle States	Weak Isotopic Charge $I_3^W$	Weak Hypercharge $Y^W$	Electric Charge $Q$
+1	L	$\begin{pmatrix} e_L \\ \nu_L \end{pmatrix}$	-1/2	-1	-1
+1	L		+1/2	-1	0
-1	R	$\begin{pmatrix} \bar{e}_R \\ \bar{\nu}_R \end{pmatrix}$	+1/2	+1	+1
-1	R		-1/2	+1	0
+1	R	$e_R$	0	-2	-1
-1	L	$\bar{e}_L$	0	+2	+1
+1	R	$\nu_R$			
-1	L	$\bar{\nu}_L$			

**absent in SM**



# Mass terms

The **Handedness** is also a crucial concept for the origin of particle masses. Any interaction giving a spin-1/2 particle a nonzero mass must flip its left- and right-handed states.

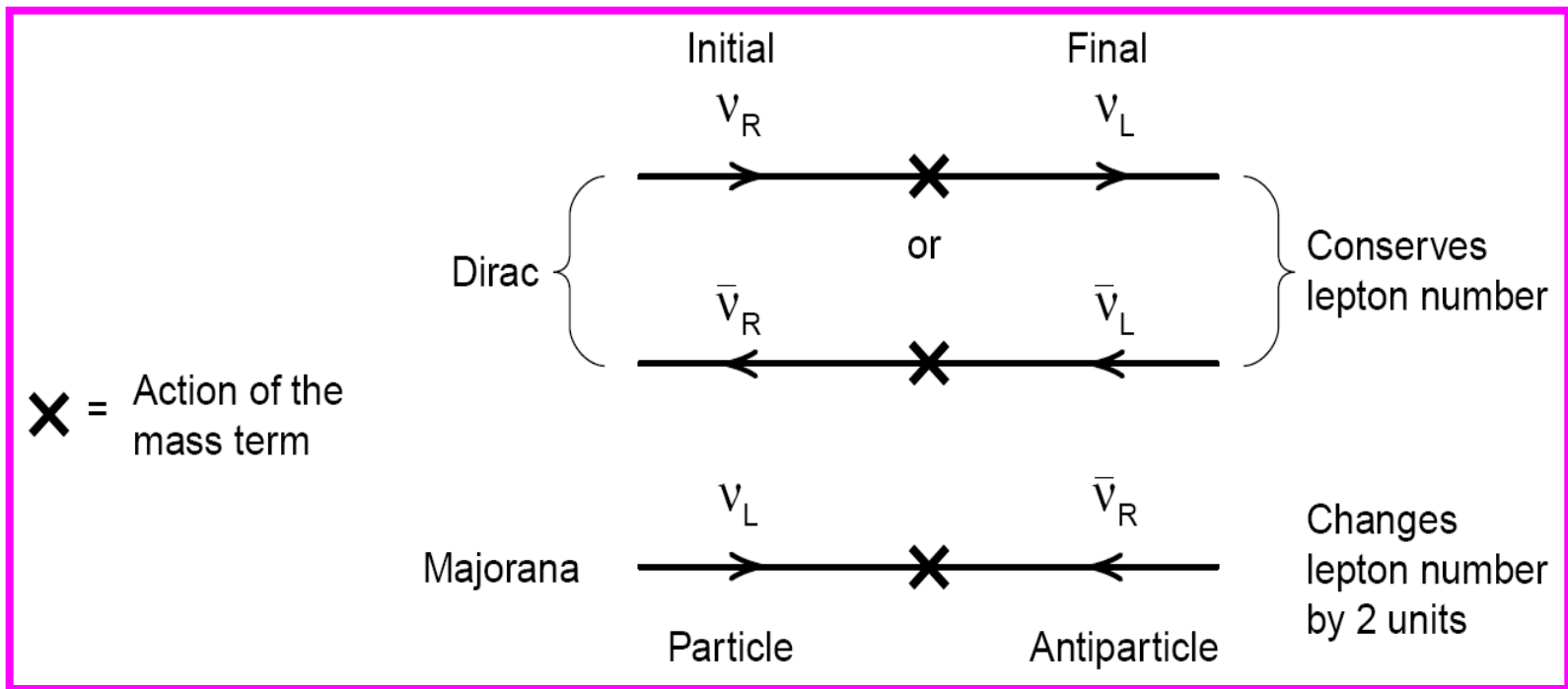

$$|e_L\rangle \propto |e_{-1/2}\rangle + m/E |e_{+1/2}\rangle$$

$$|e_R\rangle \propto |e_{+1/2}\rangle - m/E |e_{-1/2}\rangle$$

**2 handed states** in terms of **2 helicity states**:  
 if  $m = 0$ , handedness = helicity; if  $m \ll E$ , it holds approximately (in a relativistic limit).

# Helicity + Handedness

**Exercise:** which decay mode is more likely?

$$\pi^+ \rightarrow e^+ + \nu_e$$

$$\pi^+ \rightarrow \mu^+ + \nu_\mu$$

$$\begin{aligned} |\mu_L^+\rangle &\propto |\mu_{-1/2}^+\rangle + m/E |\mu_{+1/2}^+\rangle \\ |\mu_R^+\rangle &\propto |\mu_{+1/2}^+\rangle - m/E |\mu_{-1/2}^+\rangle \end{aligned}$$

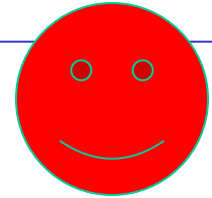

z-axis ↑

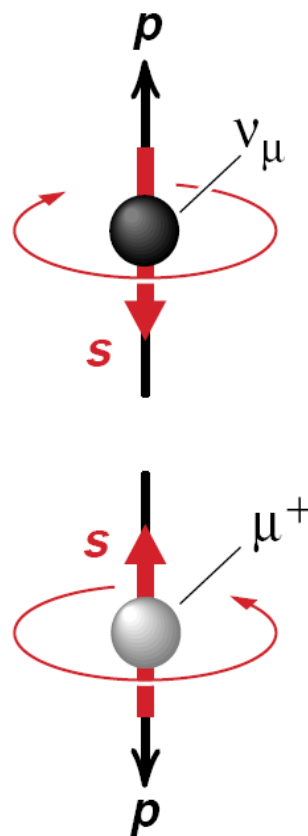
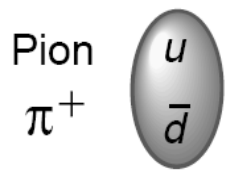

$$J_z = s_z = -\frac{1}{2}$$

The massless, left-handed neutrino is in a state of left helicity.

$$J_z = s_z = \frac{1}{2}$$

The right-handed antimuon must be produced in a state of left helicity.

Angular momentum  $J_z = 0 \longrightarrow J_z = -\frac{1}{2} + \frac{1}{2} = 0$

# Electron and its neutrino 35

The **electron** was discovered in 1897 by **Joseph Thomson**.

The electron's anti-particle, **positron**, was predicted by **Paul Dirac** in 1928, and discovered by **Carl Anderson** in 1932.

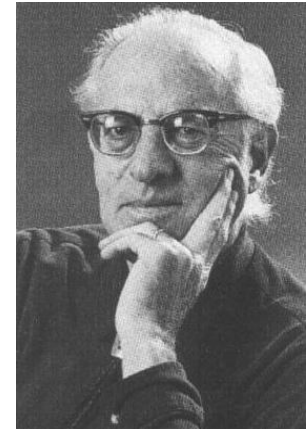
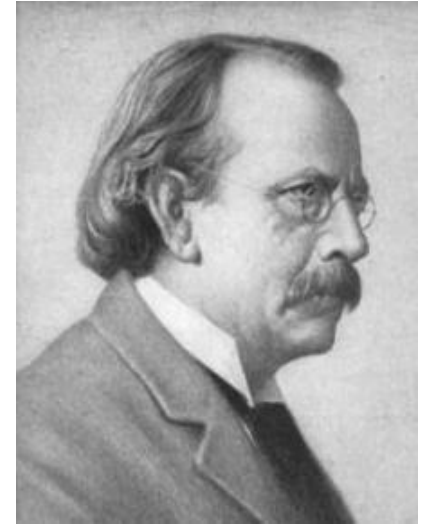

In 1956 **Clyde Cowan** and **Frederick Reines** discovered the positron's partner, **electron antineutrino**.

# Muon

The **muon** particle, a sister of the electron, was discovered in 1936 by **Carl Anderson** and his first student **S. Neddermeyer**; and independently by **J. Street *et al.***

It was not **Hideki Yukawa's** "pion". And it was the first flavor puzzle.

**Isidor Rabi** famously asked:

**Who** ordered that?



Isidor Isaac Rabi

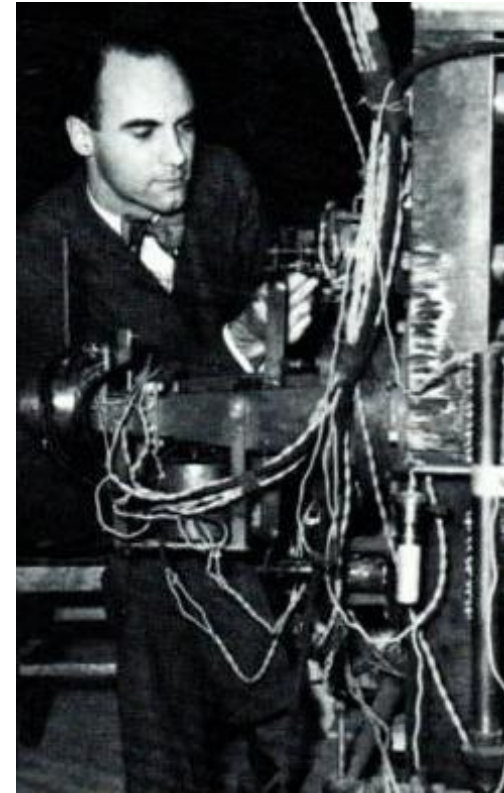

**FAMILY**

# Muon neutrino

37

The **muon neutrino** was discovered by **Leon Lederman**, **Melvin Schwartz** and **Jack Steinberger** in 1962.

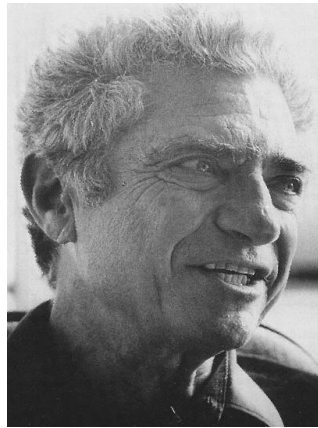

**Lee and Yang**

**Bruno Pontecorvo**

Neutrino conversion proposed by **Z. Maki**, **M. Nakagawa** and **S. Sakata** in 1962.

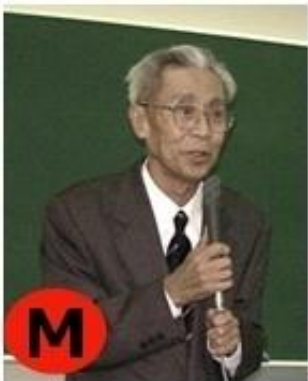

# Tau and its neutrino

38

The **tau** particle was discovered by **Martin Perl** in 1975 via:

$$e^+ + e^- \rightarrow e^\pm + \mu^\mp + \text{undetected particles}$$

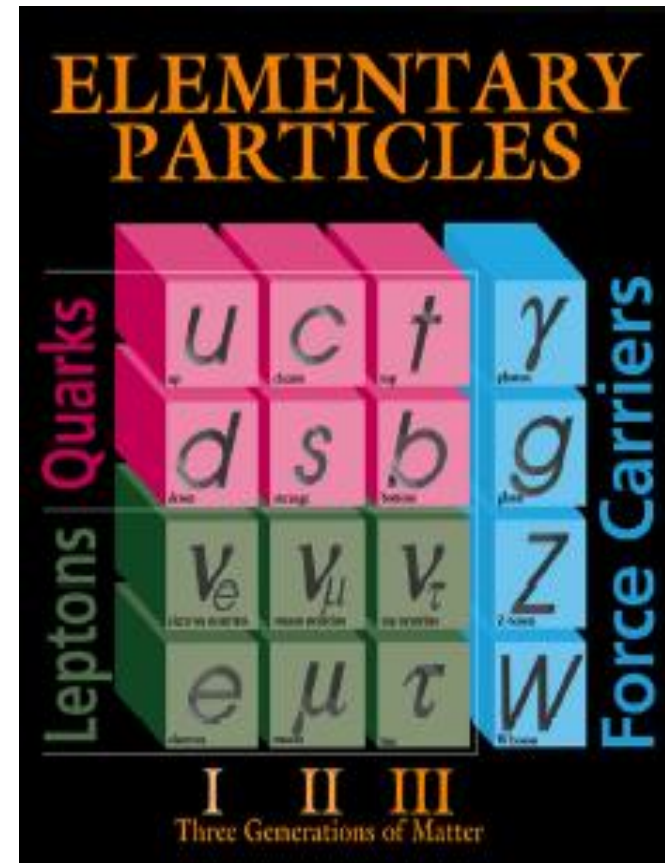
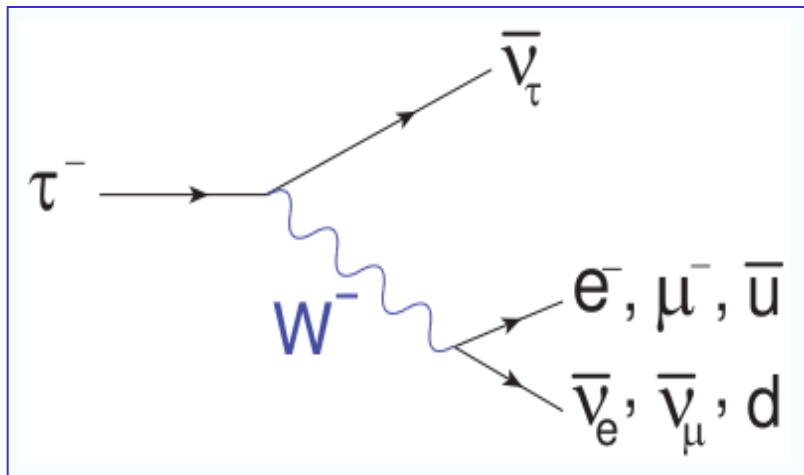

In 2000, the **tau neutrino** was finally discovered at the Fermilab.

The lepton family is complete!

# Leptonic Nobel Prizes

39

$e$	J.J. Thomson <b>1897</b> 😊	J.J. Thomson <b>1906 (NP)</b>
$\nu_e$	C.L. Cowan et al. <b>1956</b>	F.J. Reines <b>1995 (NP)</b>
$\mu$	J.C. Street et al. C.D. Anderson <b>1936</b> 😊	<b>1975 – 1936 = 1936 – 1897 = 39</b>
$\nu_\mu$	G. Danby et al. <b>1962</b>	M. Schwartz, L.M. Lederman, J. Steinberger <b>1988 (NP)</b>
$\tau$	M.L. Perl et al. <b>1975</b> 😊	M.L. Perl <b>1995 (NP)</b>
$\nu_\tau$	K. Kodama et al. <b>2000</b>	

**Antimatter: Positron.**

**Predicted by P.A.M. Dirac in 1928.**

**Discovered by C.D. Anderson in 1932; Nobel Prize in 1936.**

# Sarma-Xing Theorem

40

In 1995 it was an Indian theorist who first discovered the **39-year gap** of charged leptons.

## 2) NOBEL LEPTONS.

By [K.V.L. Sarma \(Tata Inst.\)](#), TIFR-TH-95-56, Dec 1995. 13pp.  
Submitted to Curr. Sci.

e-Print Archive: [hep-ph/9512420](#)

$$1975 + 39 = 2014$$

A summary of the discoveries made in the world of leptons is given in Table 1. We see that the third generation has started getting Nobel prizes. It is amusing that the charged-leptons crop up with a 39-year gap and may be the 4th one would show up in the year 2114. For the present, the available experimental information implies that there are no charged leptons which are heavier than tau and lighter than 45 GeV.

**My contribution:** corrected **2114** to **2014**, so the discovery would be possible **100** years earlier (last year)!



# Lepton (flavor) number

41

	$e^-$	$\nu_e$	$e^+$	$\bar{\nu}_e$	$\mu^-$	$\nu_\mu$	$\mu^+$	$\bar{\nu}_\mu$	$\tau^-$	$\nu_\tau$	$\tau^+$	$\bar{\nu}_\tau$
$L$	+1	+1	-1	-1	+1	+1	-1	-1	+1	+1	-1	-1
$L_e$	+1	+1	-1	-1	0	0	0	0	0	0	0	0
$L_\mu$	0	0	0	0	+1	+1	-1	-1	0	0	0	0
$L_\tau$	0	0	0	0	0	0	0	0	+1	+1	-1	-1

**In the SM:** (a) all neutrinos are massless; (b) the left-handed neutrino and the right-handed anti-neutrino are distinct particles which cannot transmute into each other.

**Law One:** the total lepton number is conserved. But it will be violated if neutrinos have finite masses and are the Majorana particles.

**Law Two:** the individual lepton flavor number is also conserved. But it has been proved to be violated in the neutrino sector.

# Examples

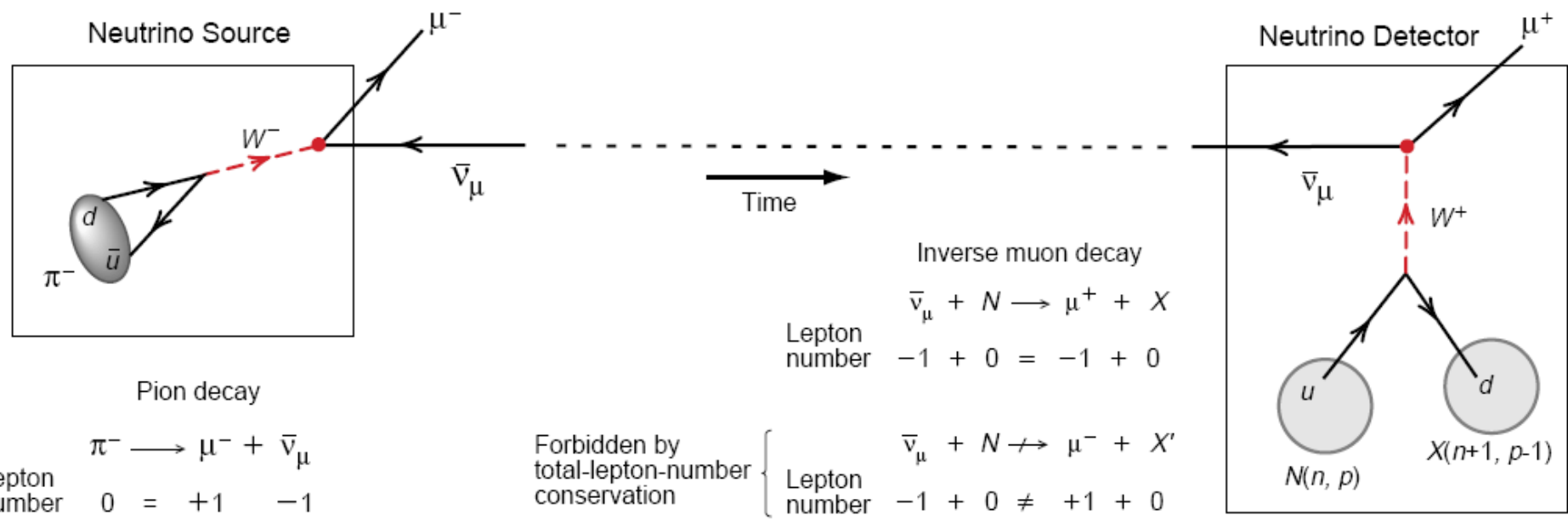

A  
L  
L  
O  
W  
E  
D

- $\mu^+ \rightarrow e^+ + \gamma$
- $\mu^+ \rightarrow e^+ + e^- + e^+$
- $\mu^- + N(n, p) \rightarrow e^- + N(n, p)$
- $\mu^- + N(n, p) \rightarrow e^+ + N(n + 2, p - 2)$
- $\mu^+ \rightarrow e^+ + \bar{\nu}_e + \nu_\mu$

FORBIDDEN

**Exercise: why they are forbidden?**

# Appendix: B and L

43

**Question:** Why ordinary particle interactions, restricted by **local gauge invariance** + **renormalizability** in the SM, conserve the baryon number  $B$ , the total lepton number  $L$  and lepton flavor numbers  $L_e, L_\mu, L_\tau$  (i.e., global symmetries of the SM)?

**E. Witten** (Neutrino 2000): “Using the fields of the SM, it is impossible **at the classical level** to violate the baryon and lepton number symmetries by renormalizable interactions.”

**G. 't Hooft** (1976): **Non-perturbative quantum effects** can break most of the SM global symmetries, preserving only  $B - L$ .

Renormalizable interactions have dimensionless couplings, but unrenormalizable interactions may be suppressed by an inverse power of  $M$  with  $M$  being the scale where the SM breaks down.

$$L_{\text{effective}} = L_{\text{SM}} + \sum_n \frac{1}{M^n} O^{4+n}$$