Status and progress of TPC detector module and prototype

Huirong Qi

Institute of High Energy Physics, CAS

3rd, November, 2017, Annual Joint Meeting, IHEP

Outline

- Physics requirements
- Status of TPC module R&D
- Status of TPC prototype R&D
- Summary

Physics requirements

TPC requirements for collider concept

TPC could be as one tracker detector option for CEPC, 1M ZH events in 10yrs $E_{\text{cm}} \approx 250$ GeV, luminosity $\sim 2 \times 10^{34} \text{ cm}^{-2}\text{s}^{-1}$, can also run at the Z-pole

The voxel occupancy takes its maximal value between 2×10^{-5} to 2×10^{-7} , which is safety for the Z pole operation. Of course, it is well for Higgs run too.

<https://doi.org/10.1088/1748-0221/12/07/P07005>

TPC detector concept:

- ❑ Motivated by the H tagging and Z
- ❑ Main tracker detector with TPC
- ❑ ~ 3 Tesla magnetic field
- ❑ $\sim 100 \mu\text{m}$ position resolution in $r\phi$
- ❑ Systematics precision ($< 20 \mu\text{m}$ internal)
- ❑ Large number of 3D points (~ 220)
- ❑ Distortion by IBF issues
- ❑ dE/dx resolution: $< 5\%$
- ❑ Tracker efficiency: $> 97\%$ for $p_T > 1\text{GeV}$

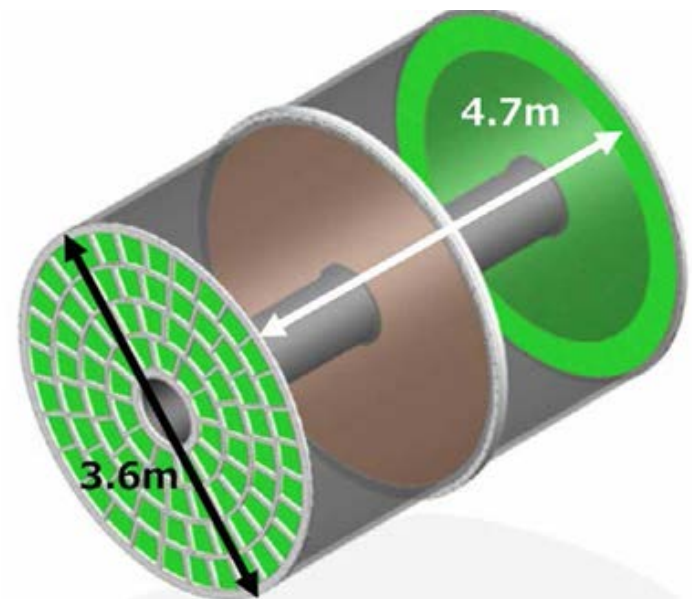

TPC detector concept

Technical challenges for TPC

Ion Back Flow and Distortion :

- ❑ $\sim 100 \mu\text{m}$ position resolution in $r\phi$
- ❑ Distortions by the primary ions at CEPC are negligible
- ❑ More than 10000 discs co-exist and distorted the path of the seed electrons
- ❑ The ions have to be cleared during the $\sim \mu\text{s}$ period continuously
- ❑ Continuous device for the ions
- ❑ Long working time

Calibration and alignment:

- ❑ Systematics precision ($< 20 \mu\text{m}$ internal)
- ❑ Geometry and mechanic of chamber
- ❑ Modules and readout pads
- ❑ Track distortions due to space charge effects of positive ions

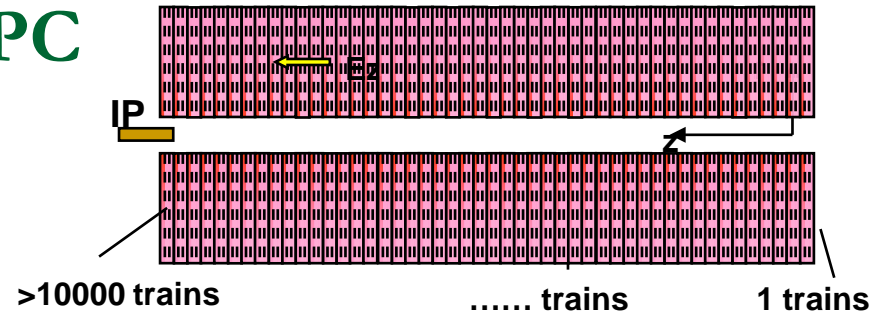

Amplification ions @CEPC

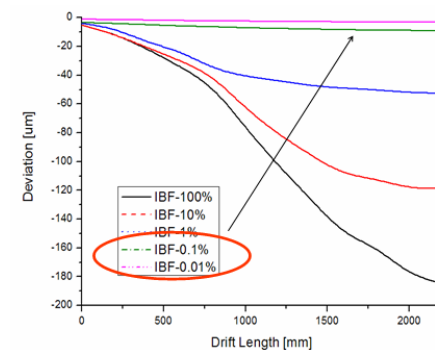
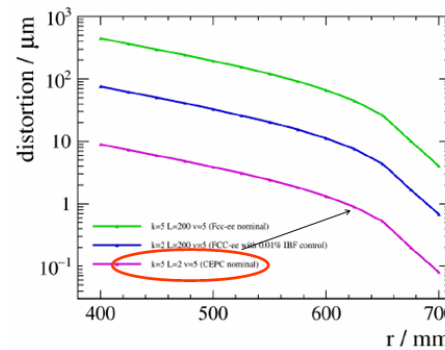

Evaluation of track distortions

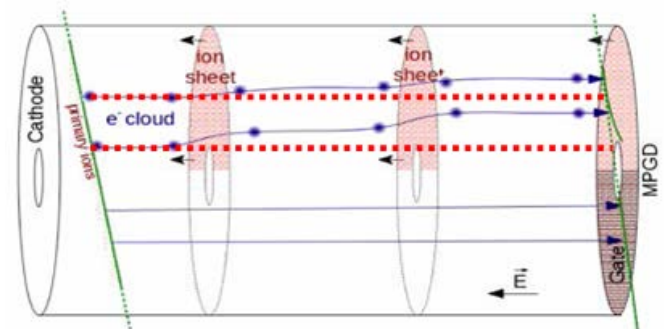

Ions backflow in drift volume for distortion

Options of technical solution

Continuous IBF module:

- ❑ **Gating device may be used for Higgs run**
- ❑ **Open and close time of gating device for ions: $\sim \mu\text{s}$ -ms**
- ❑ **No Gating device option for Z-pole run**
- ❑ **Continuous Ion Back Flow due to the continuous beam structure**
- ❑ **Low discharge and spark possibility**

Laser calibration system:

- ❑ **Laser calibration system for Z-pole run**
- ❑ **The ionization in the gas volume along the laser path occurs via two photon absorption by organic impurities**
- ❑ **Calibrated drift velocity, gain uniformity, ions back in chamber**
- ❑ **Calibration of the distortion**
- ❑ **Nd:YAG laser device@266nm**

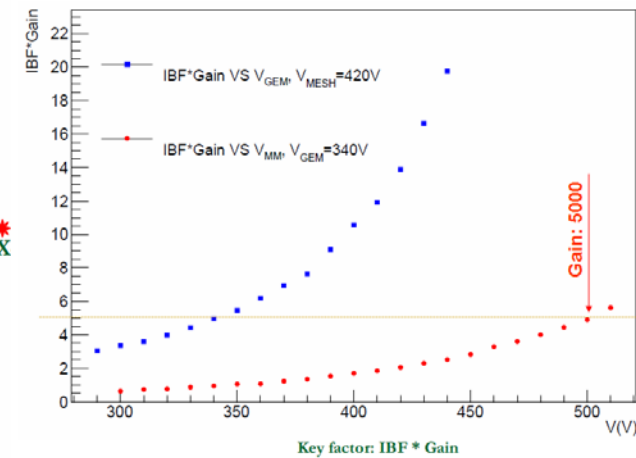
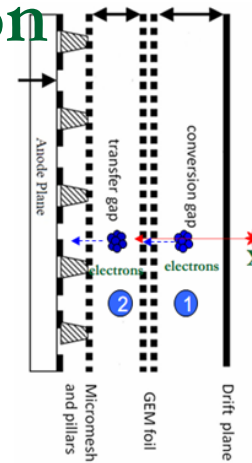

Continuous IBF prototype and IBF \times Gain

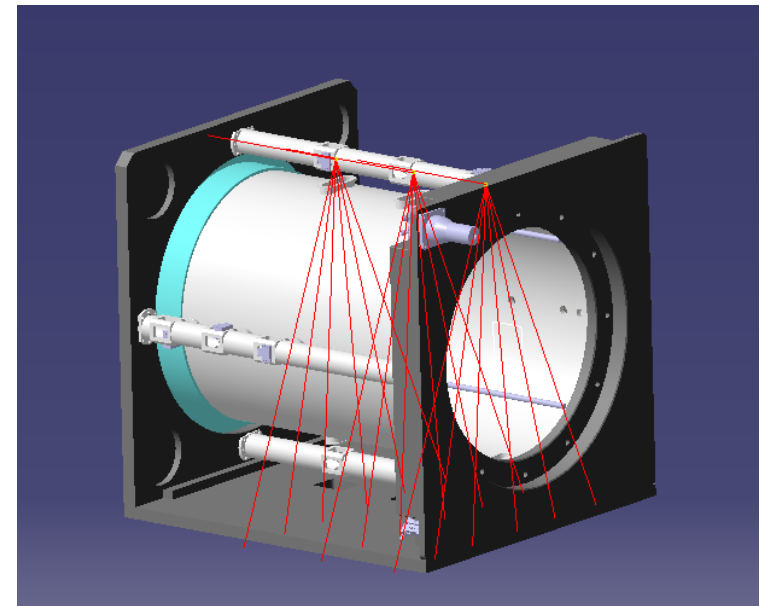

TPC prototype integrated with laser system

Status of TPC module R&D

High rate at Z pole

ArXiv: 1704.04401

- **Voxel occupancy**
 - The number of voxels /signal **Manqi's talk**
 - 9 thousand Z to qq events
 - 60 million hits are generated in sample
 - 4000-6000 hits/(Z to qq) in TPC volume
 - Average hit density: 6 hits/mm²
 - Peak value of hit density: 6 times
 - Voxel size: 1mm × 6mm × 2mm
 - 1.33×10^{14} number of voxels/s @DAQ/40MHz
 - Average voxel occupancy: 1.33×10^{-8}
 - Voxel occupancy at TPC inner most layer: $\sim 2 \times 10^{-7}$
 - Voxel occupancy at TPC inner inner most layer : $\sim 2 \times 10^{-5}$ @FCCee benchmark luminosity

The voxel occupancy takes its maximal value between 2×10^{-5} to 2×10^{-7} , which is safety for the Z pole operation.

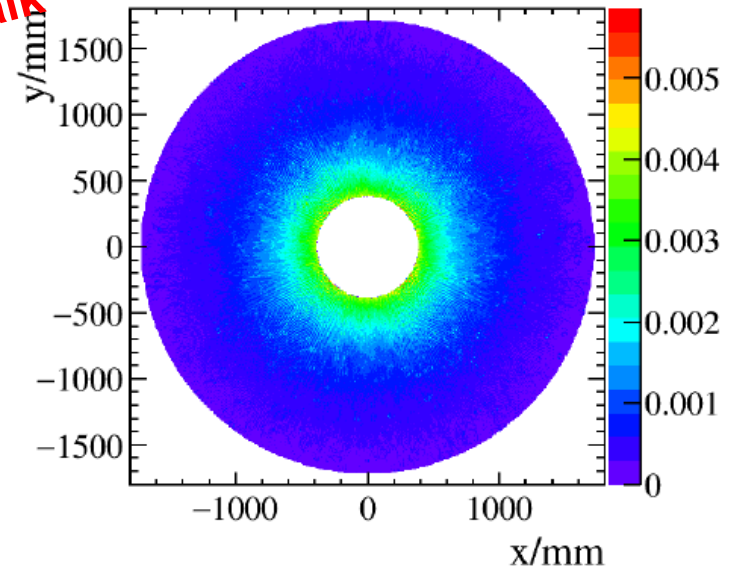

Hit map on X-Y plan for Z to qq events

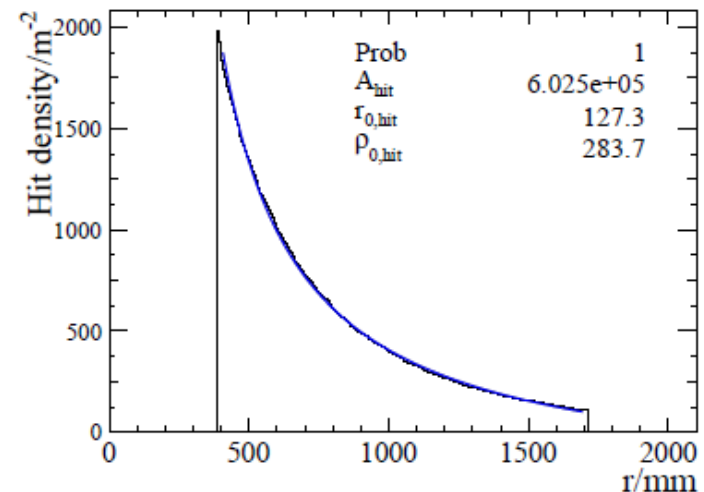

Hit density as a function of radius

Requirements of Ion Back Flow

Manqi, Mingrui, Huirong

- Electron:
 - Drift velocity $\sim 6-8\text{cm}/\mu\text{s}@200\text{V}/\text{cm}$
 - Mobility $\mu \sim 30-40000 \text{ cm}^2/(\text{V}\cdot\text{s})$
- Ion:
 - Mobility $\mu \sim 2 \text{ cm}^2/(\text{V}\cdot\text{s})$
 in a “classical mixture” (Ar/Iso)

$$S_N = \sqrt{\left(\frac{\partial f}{\partial x_1}\right)^2 S_{x_1}^2 + \left(\frac{\partial f}{\partial x_2}\right)^2 S_{x_2}^2 + \left(\frac{\partial f}{\partial x_3}\right)^2 S_{x_3}^2}$$

Standard error propagation function

Key parameters:

$N_{\text{eff}}=30/$ Gain=5000 /T2K gas

Z pole run@ 10^{34}

$r=400\text{mm}$ / $k=\text{IBF}\cdot\text{Gain}=5$

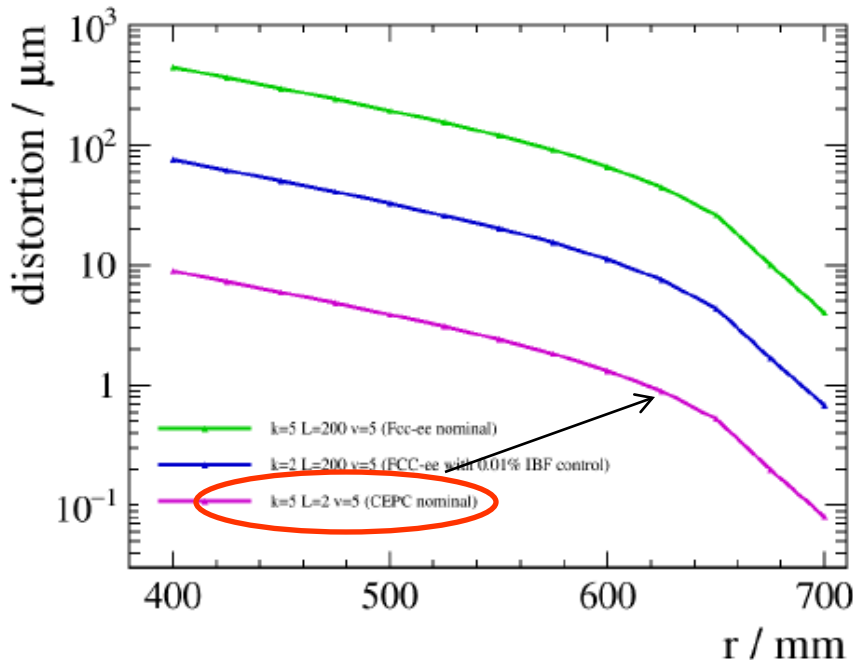

Distortion of as a function of electron initial r position

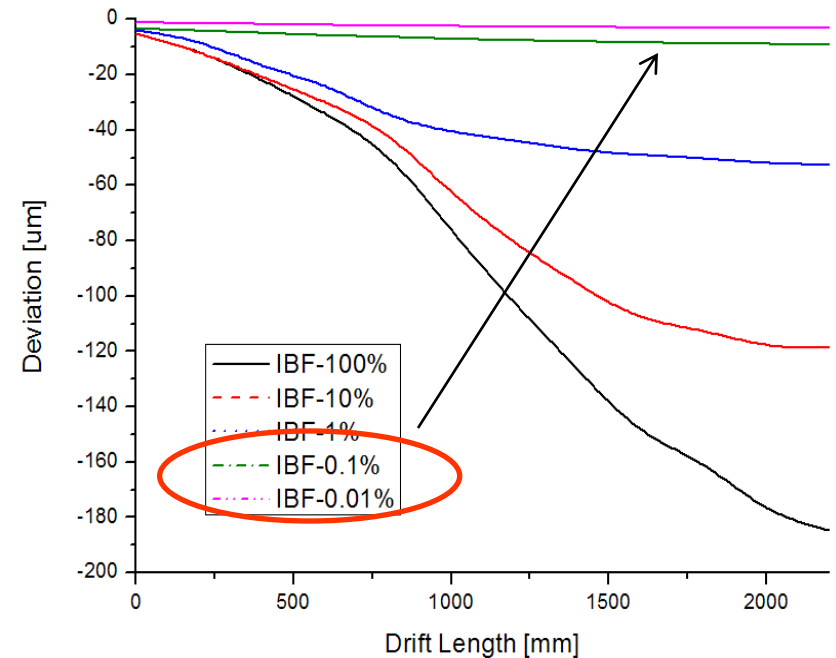

Evaluation of track distortions due to space charge effects of positive ions

IBF simulation

Yulian, Haiyun, Huirong

- Garfield++/ANSYS to simulate the ions back to drift
 - 420LPI/ 590LPI/ 720LPI/1000LPI
 - E_a is electric field of amplifier of Micromegas
 - Standard GEM foil (70-50-70)
 - Standard Bulk-Micromegas (420LPI)
 - **GEM optimization: wider hole GEM/KEK**
 - **MM optimization: 590LPI mesh/Saclay**

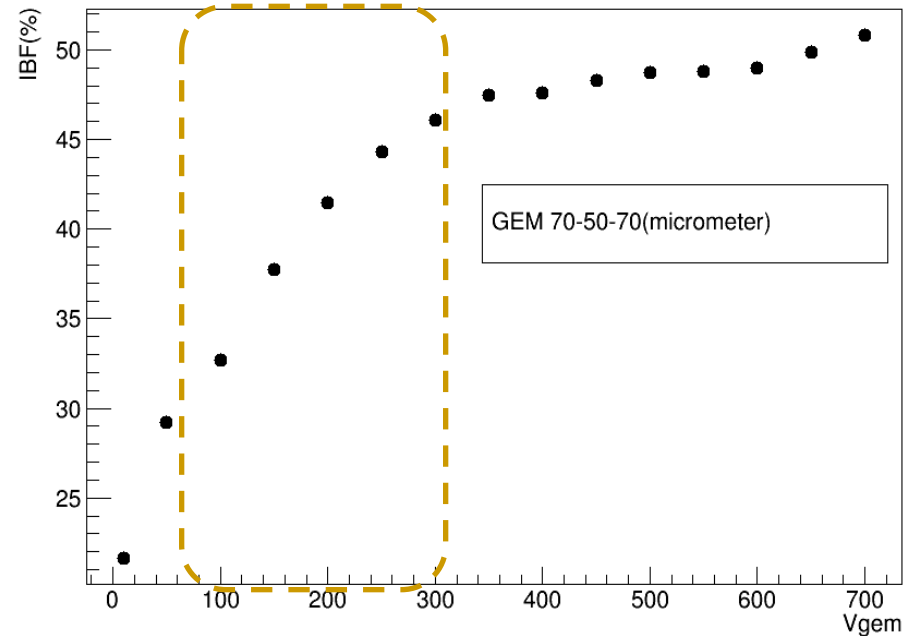
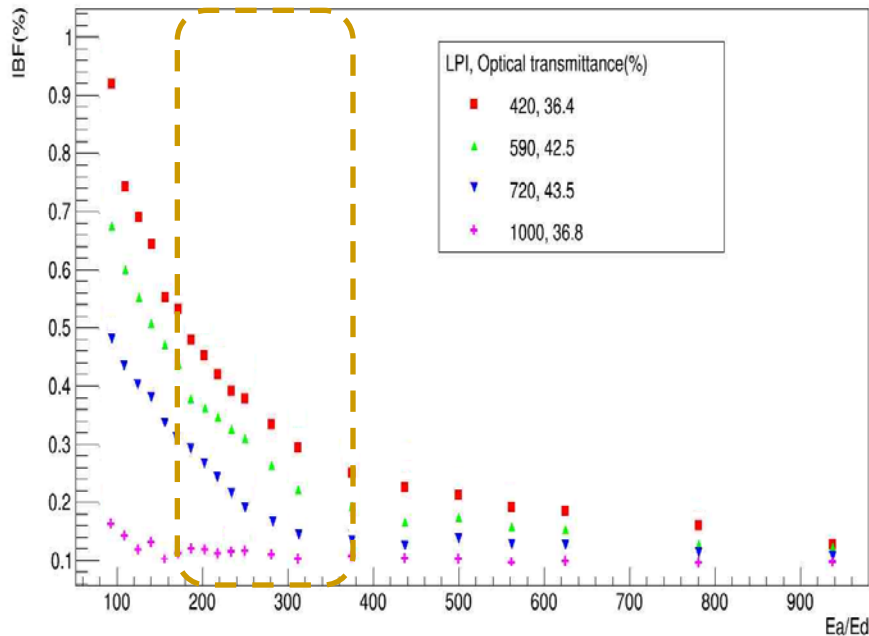
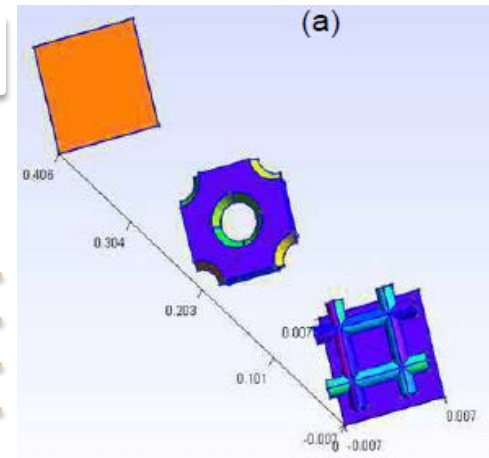
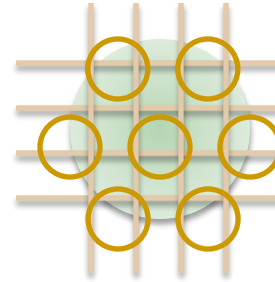

Electric field of amplifier VS Electric field of Drift and VGEM

Test of the new module

- Test with GEM-MM module
 - New assembled module
 - Active area: 100mm×100mm
 - X-tube ray and ^{55}Fe source
 - Bulk-Micromegas from Saclay
 - Standard GEM from CERN
 - Additional UV light device
 - Avalanche gap of MM:128 μm
 - Transfer gap: 2mm
 - Drift length:2mm~200mm
 - Mesh: 400LPI

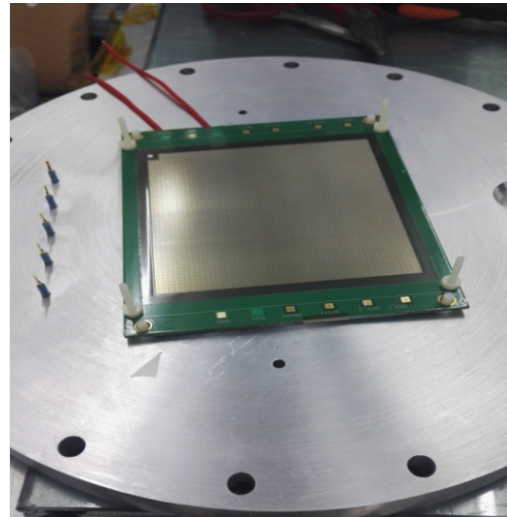
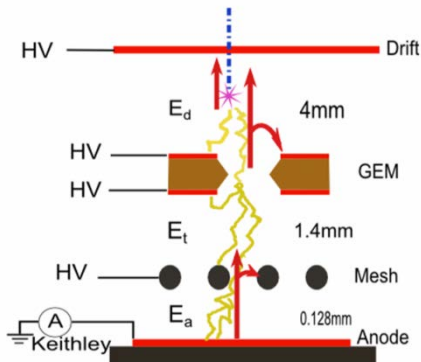

Micromegas(Saclay)

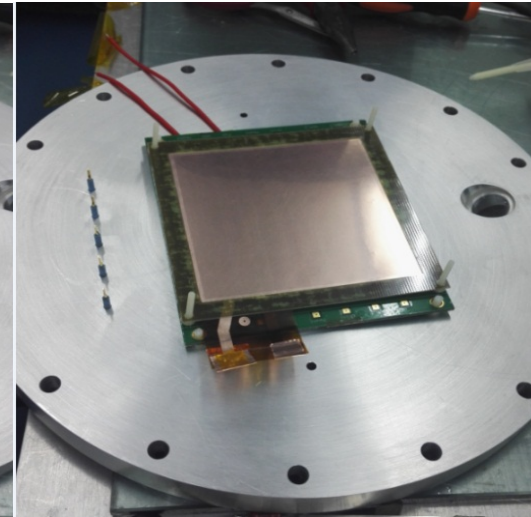

GEM(CERN)

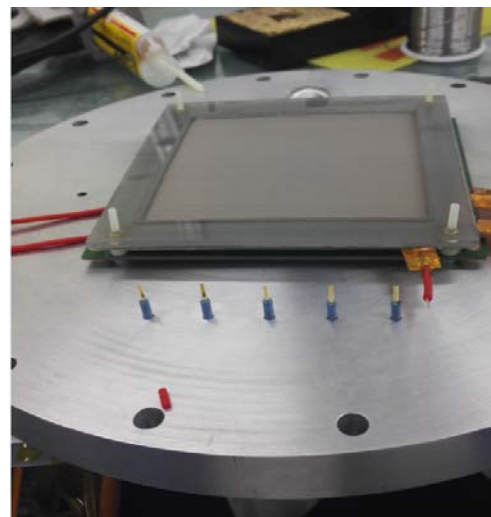

Cathode with mesh

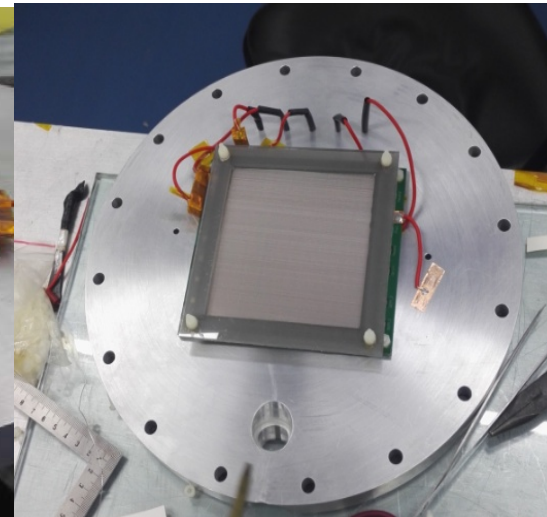

GEM-MM Detector

Measurement of GEM-MM module

- Test with GEM-MM module
 - Keithley Electrometers for Ultra-Low Current Measurements: pA~mA
 - Keithley: 6517B
 - Test of cathode of the module
 - Test of readout anode of the module
 - Labview interface of the low current to make the record file automatically

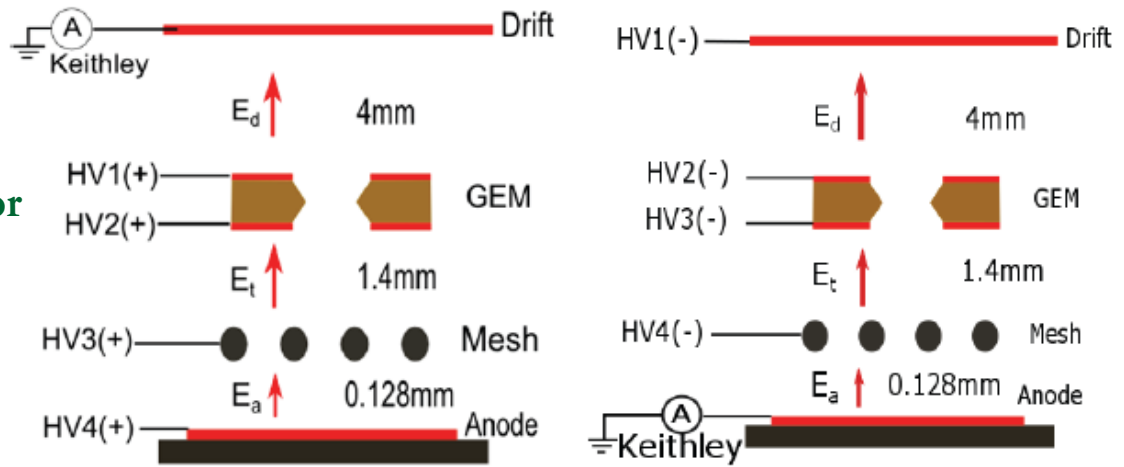

Measurement of the low current

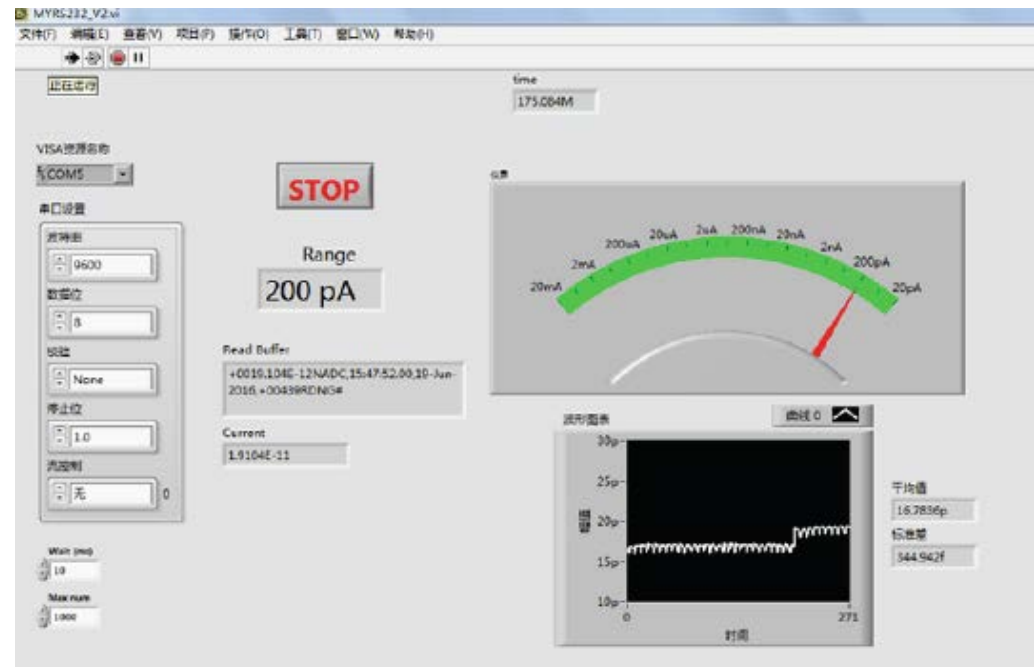

IBF of GEM-MM module

IBF of the GEM-MM

- Electric field: 100V/cm and 500V/cm
- IBF value comparison
- Optimization of $E_t = 100\text{V/cm}$
- $E_d/E_t/E_d=2/1/5$
- $V_{\text{GEM}}=340\text{V}$ and $V_{\text{mesh}}=520\text{V}$
- Total gain: 3000~4000

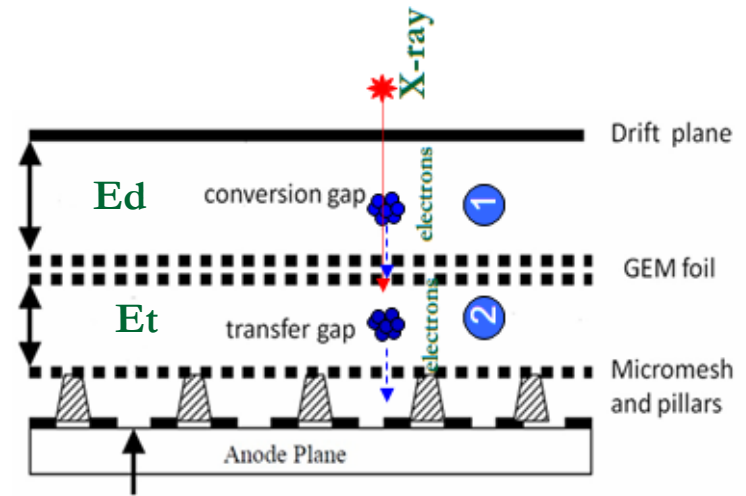

Schematic of the Gain with MM

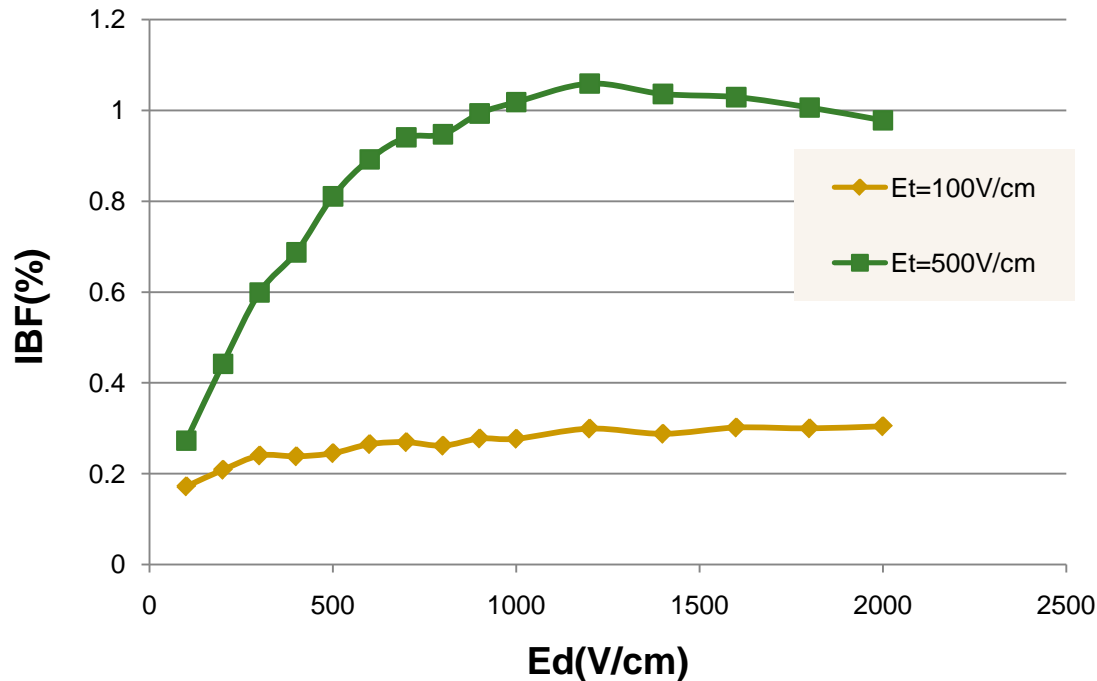

IBF values with the E_d and E_t in the GEM-MM detector

IBF test results

DOI: [10.1088/1674-1137/41/5/056003](https://doi.org/10.1088/1674-1137/41/5/056003)

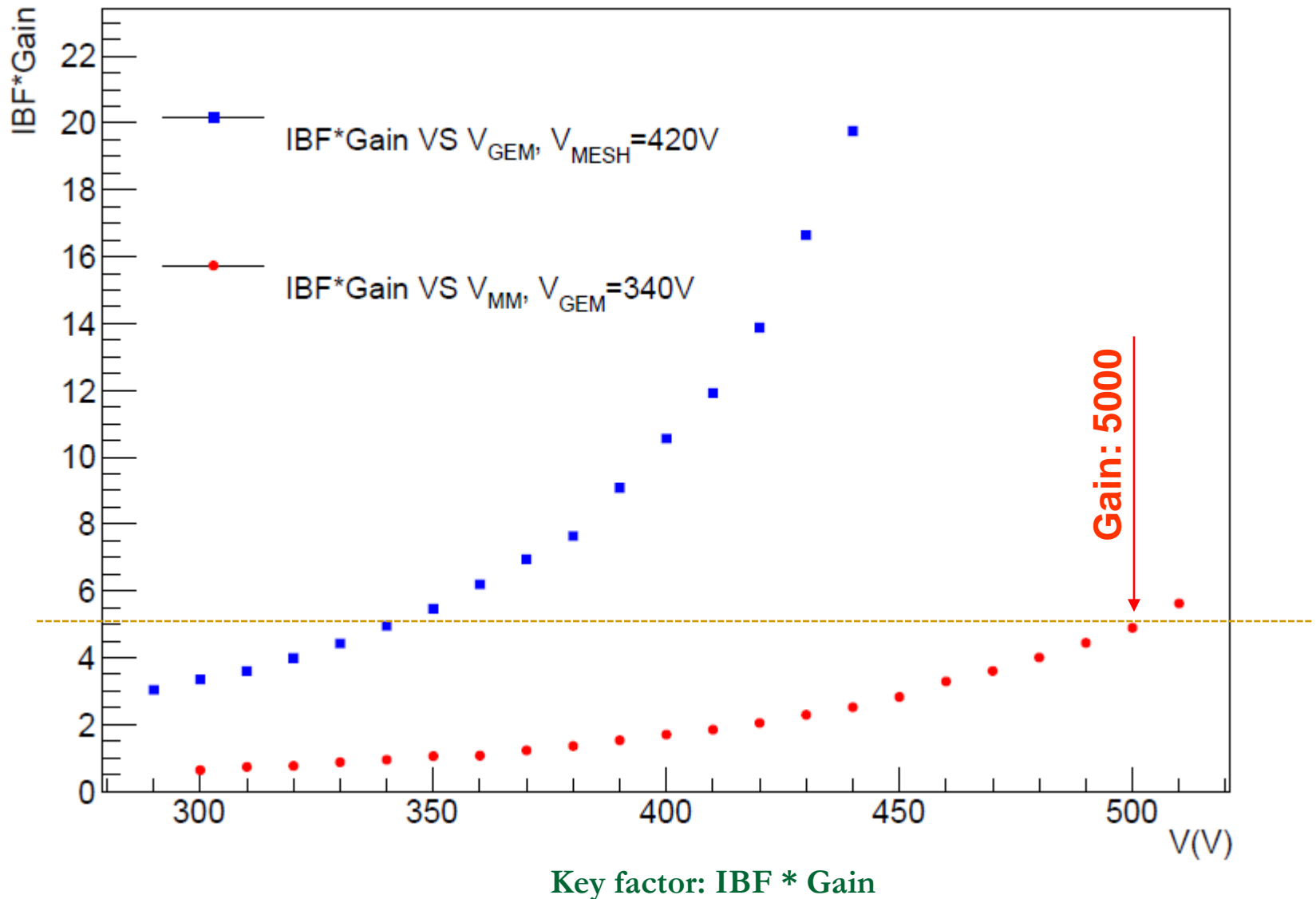

Status of TPC prototype R&D

Parameters of the TPC prototype

- To aim that the small TPC prototype for the estimation of the distortion due to the IBF, and the study of related physics parameters
- To mimic the bunch structure & the ions distortion with UV light and laser split beam
- Main parameters
 - Drift length: 510mm
 - Readout active area: 200mm × 200mm
 - Integrated the laser and UV lamp device
 - Wavelength of laser: 266nm
 - GEMs/Micromegas as the readout
 - Materials: Non-magnetic material (Stainless steel, Aluminum)

Why UV light study

- ❑ IBF measurement methods
 - ❑ ^{55}Fe radioactive source
 - ❑ X tube machine
 - ❑ Synchrotron radiation
 - ❑ **UV light by the photoelectric effect**

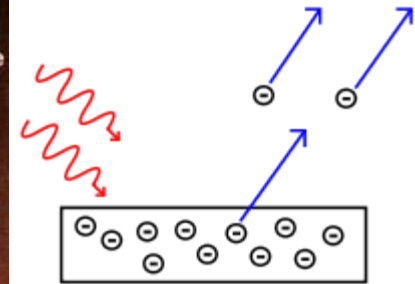

Photoelectric effect

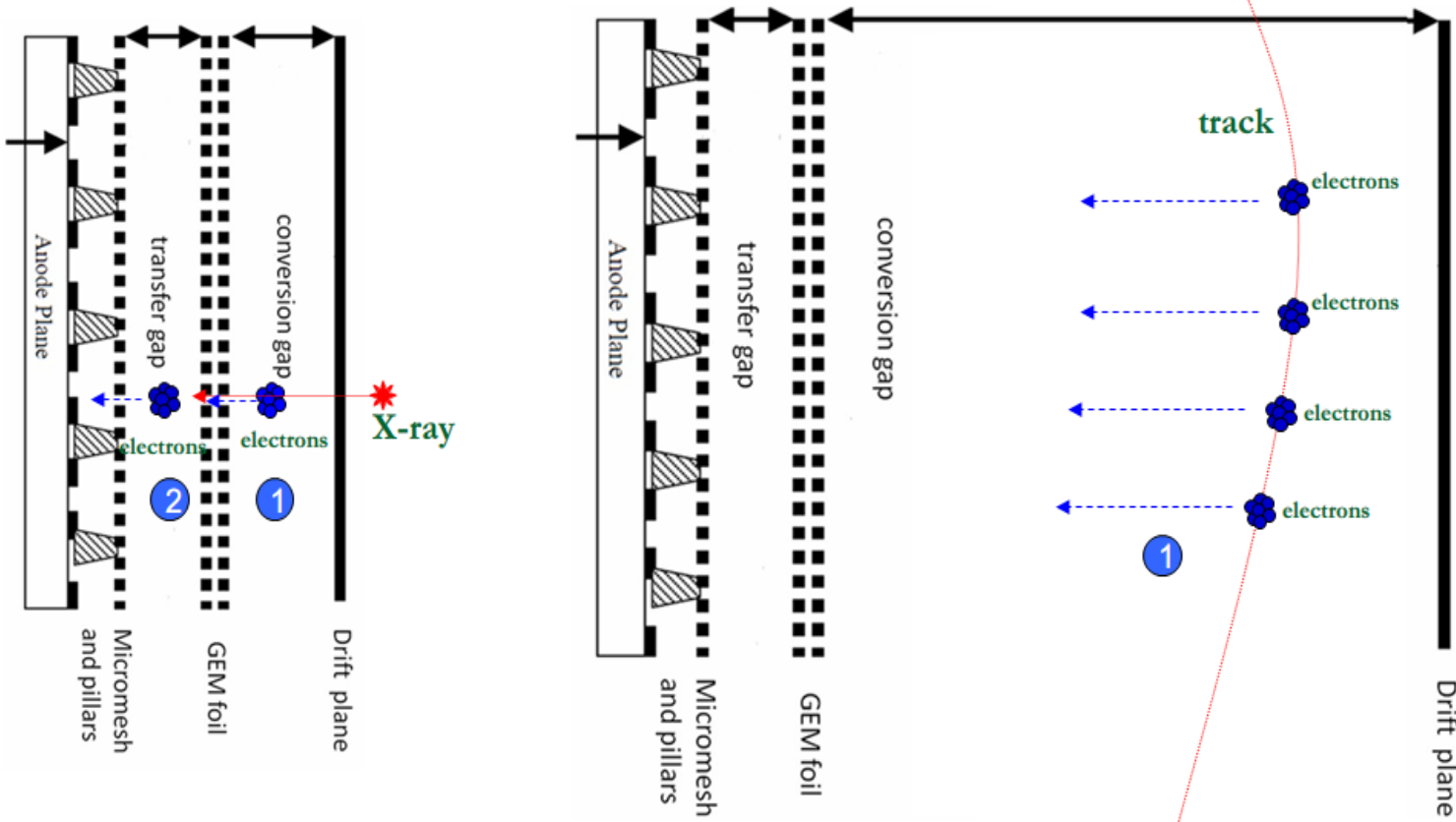

Diagram of the IBF test with the module

UV test of the new module

- UV lamp measurement
 - New designed and assembled UV test chamber
 - Active area: 100mm×100mm
 - Deuterium lamp and aluminum film
 - Principle of photoelectric effect
 - Wave length: 160nm~400nm
 - Fused silica: 99% light trans.@266nm
 - Improve the field cage in drift length



Deuterium lamp
X2D2 lamp

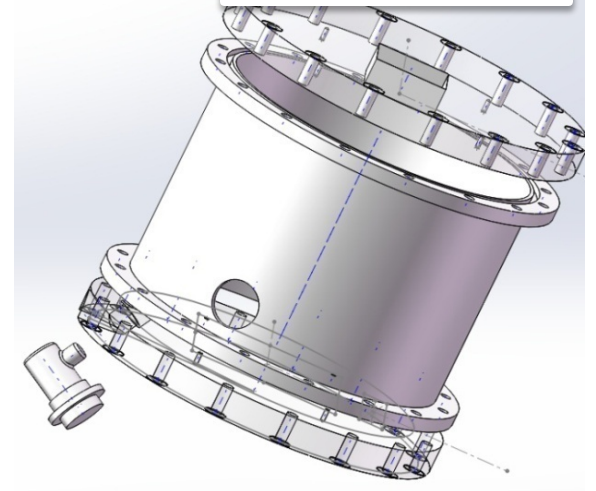

UV test geometry with GEM-MM

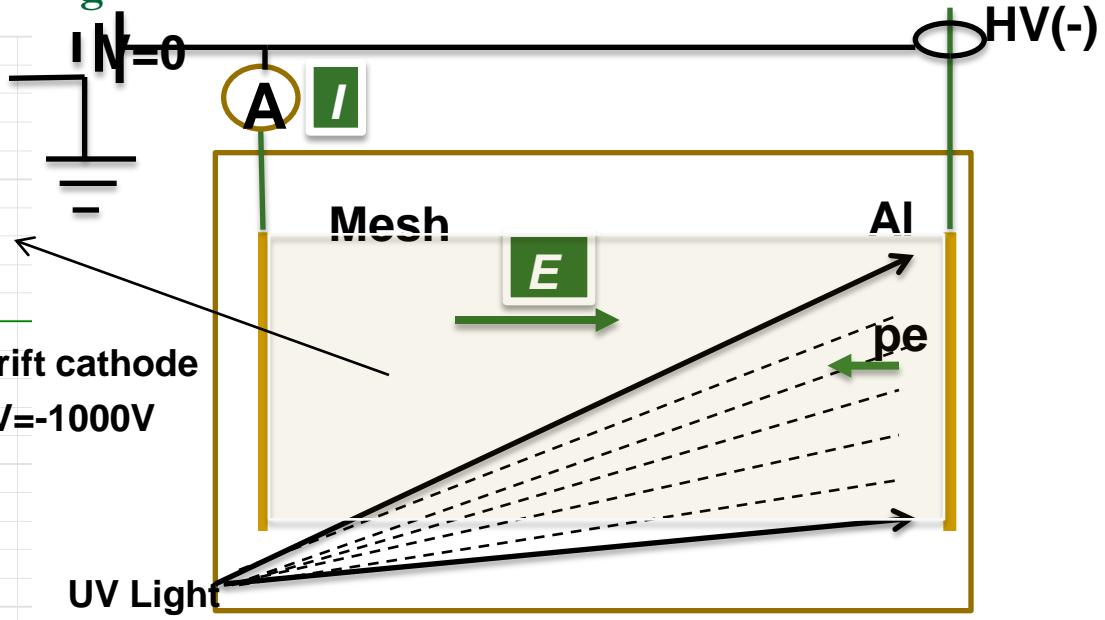
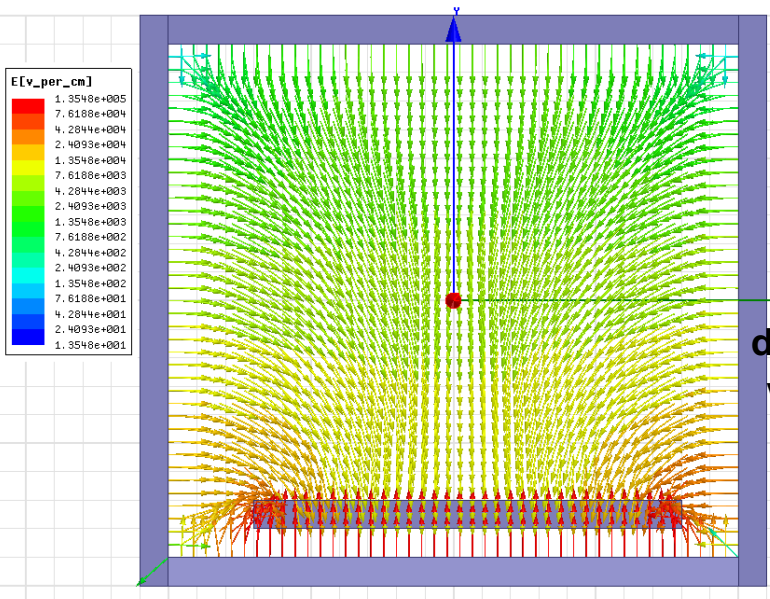
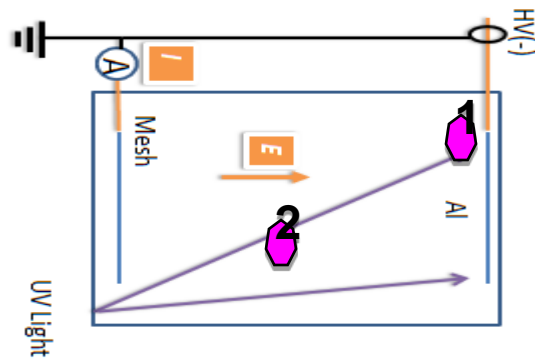

Diagram of the UV test with new module

Electrons produced by UV

- Re-mounted the UV light
 - Two mixture gases
 - High E test
 - Ar gas purity: 99.999%
 - iC4H10 gas purity: 99.99%
 - CO2 gas purity: 99.999%
 - CF4 gas purity: 99.99%
- About 31000 electrons/s.mm²
- Electrons from Al
- Electrons from drift length at 266nm UV light (~MIPs)



UV Shining diagram

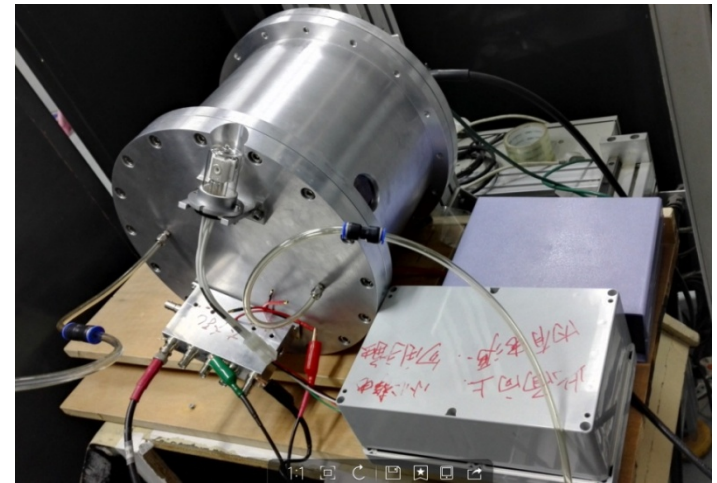
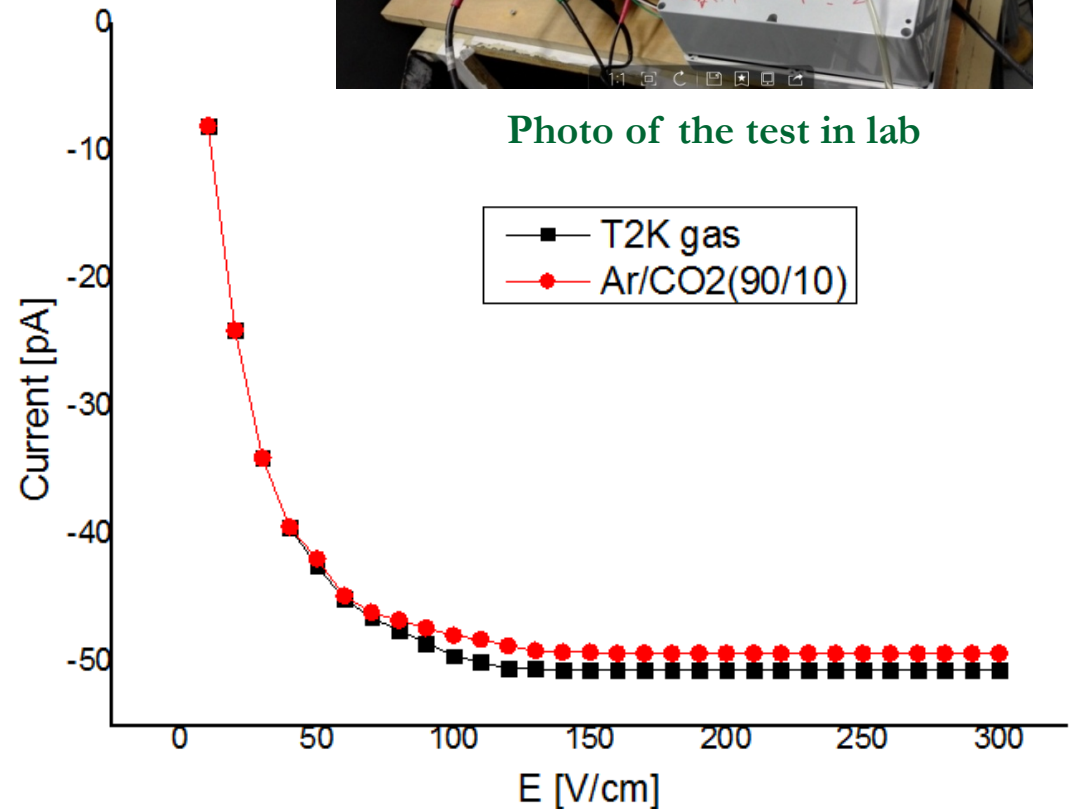

Photo of the test in lab



Current VS Electric field in drift length

Electrons produced by UV

- ❑ To mimic the bunch structure & the ions distortion with UV light and laser split beam
- ❑ In the case of ILD-TPC
 - Bunch-train structure of the ILC
 - Power pulsing mode
- ❑ In the case of CEPC-TPC
 - Bunch-train structure of the CEPC

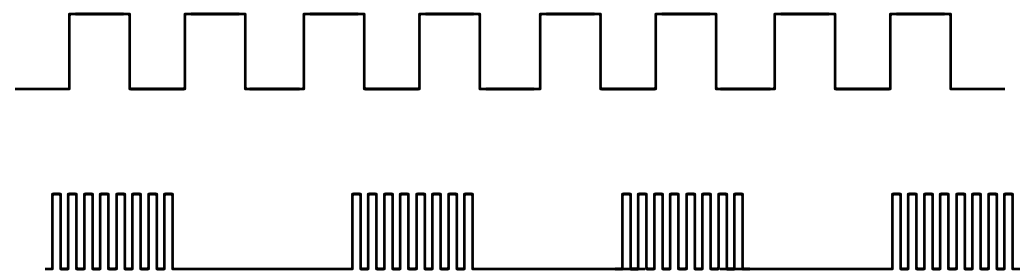
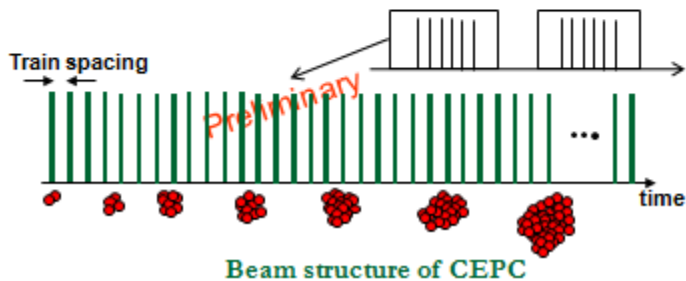
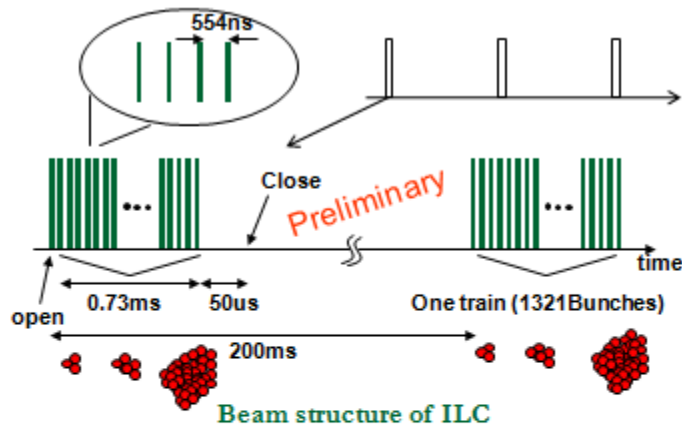
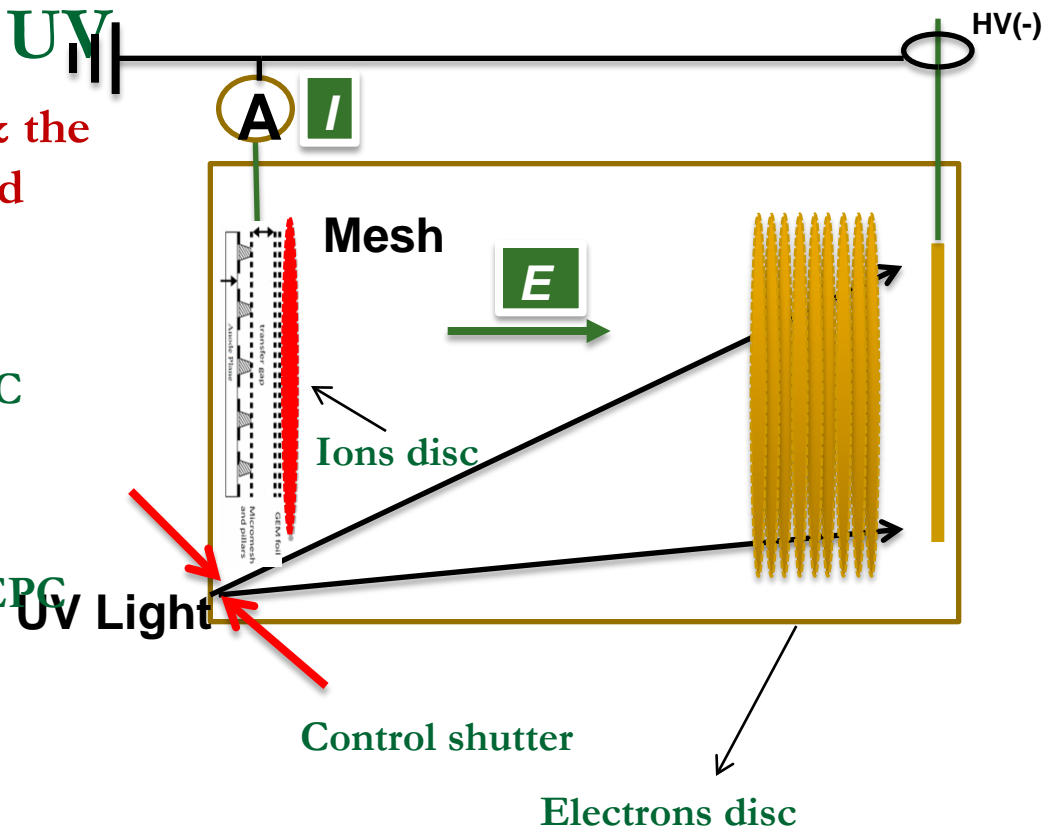

Shutter time similar to ILC and CEPC beam structure

Signal of the laser with $\Phi 1\text{mm}$ @266nm

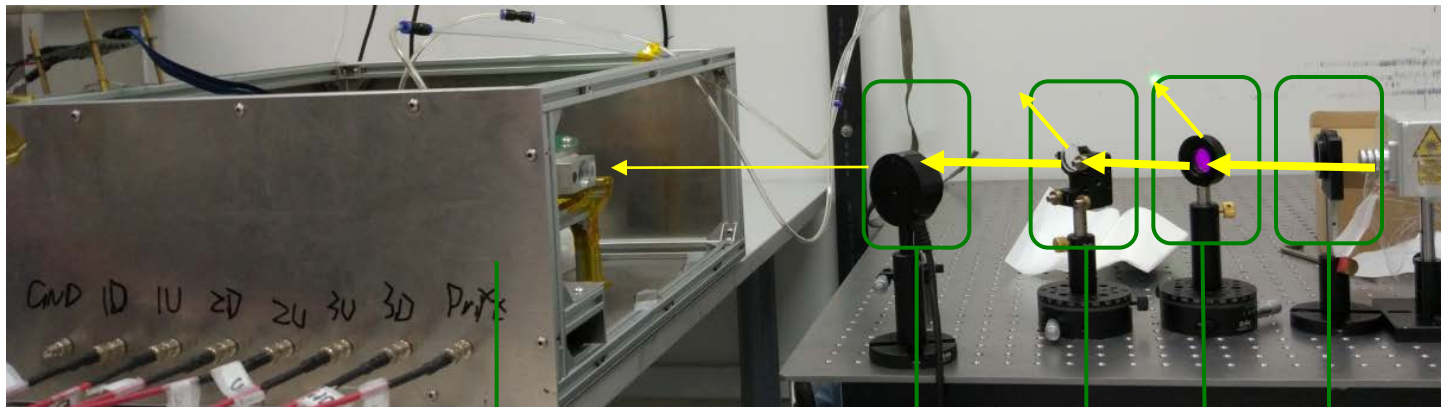

Triple GEMs detector

Hole collimator $\Phi 1\text{mm}$

Trans/refle. =1:99

Transmission mirror

Transmission mirror

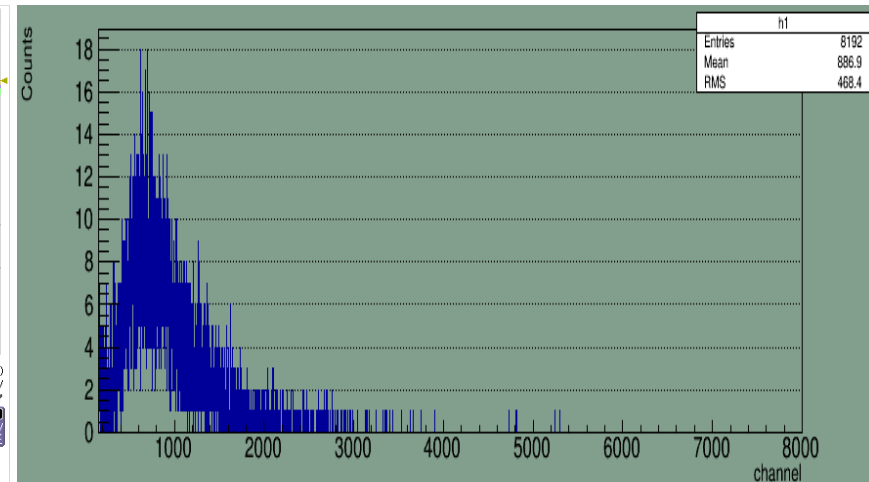
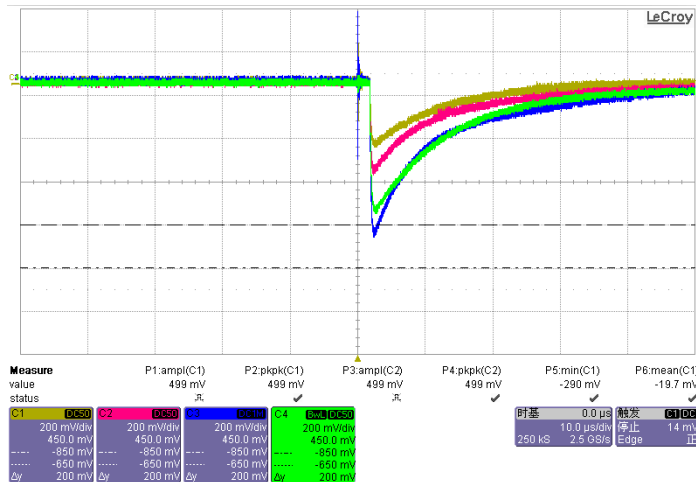

Signal of the laser with $\Phi 1\text{mm}$ @Charge sensitive AMP/12mV/fC

Collimator@ $\Phi 1 \sim \Phi 12\text{mm}$

- ❑ Laser beam with expander mirror: $5\text{mm} \times 3$
- ❑ Primary laser power: $170\mu\text{J}$
- ❑ Gain: ~ 3000

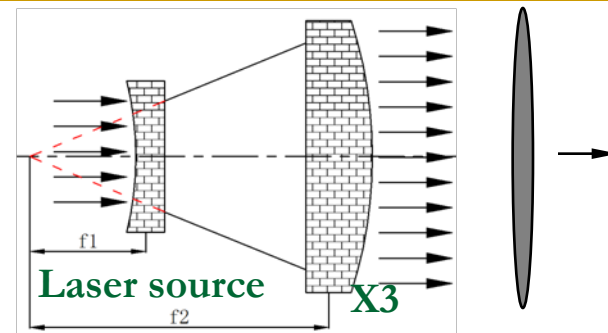

直径/mm	12	9.5	7.5	5	4	2.5	1.5	1
面积/mm ²	113.1	70.882	44.179	19.635	12.566	4.9087	1.7671	0.785
道数	6648	5990	5717	4856	4177	1853	779	267
幅度/mV	1411.5	1270.6	1212.2	1027.8	882.47	384.9	154.96	45.34

入射光斑激光信号随面积变化关系

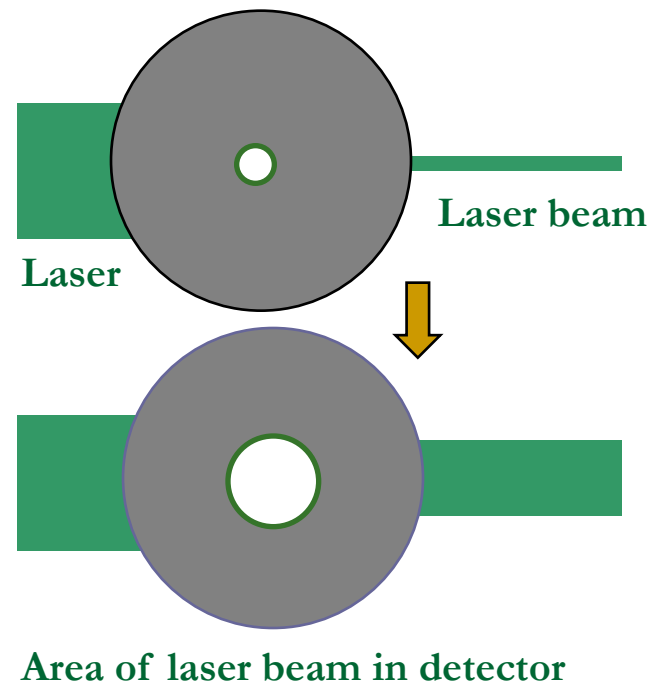
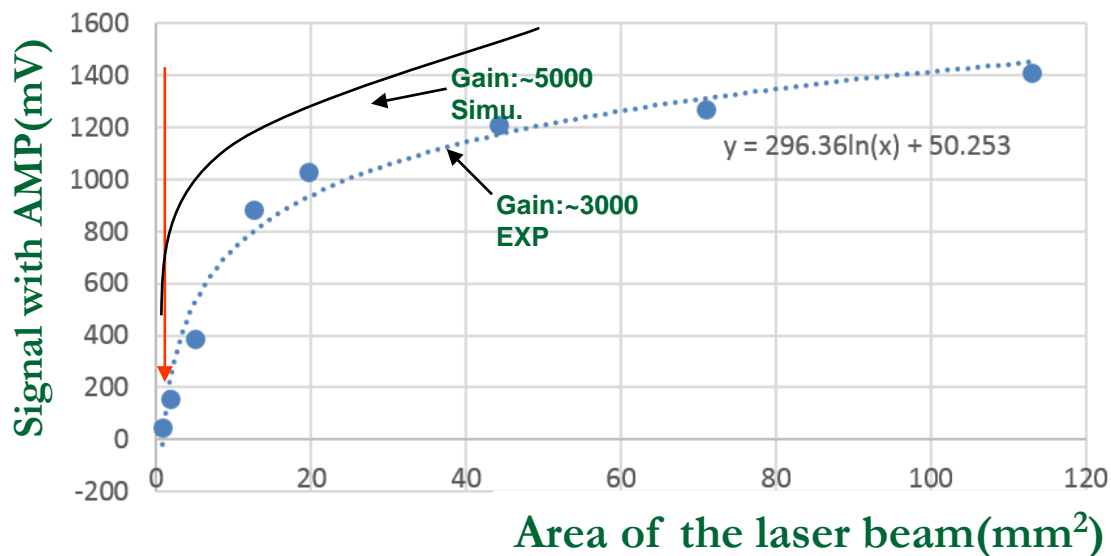

Divide and reflection mirrors

- ❑ Laser wave for the divide and reflection mirrors: 266nm
- ❑ Size: $\sim 0.8\text{mm} \times 0.8\text{mm}$
- ❑ Number of the divide trackers: 6 **Optimization**
- ❑ Stainless steel support integrated the laser mirrors
- ❑ Reflection efficiency: $>99\% @ 266\text{nm}$
- ❑ Reflection position accuracy $1/30$ degree

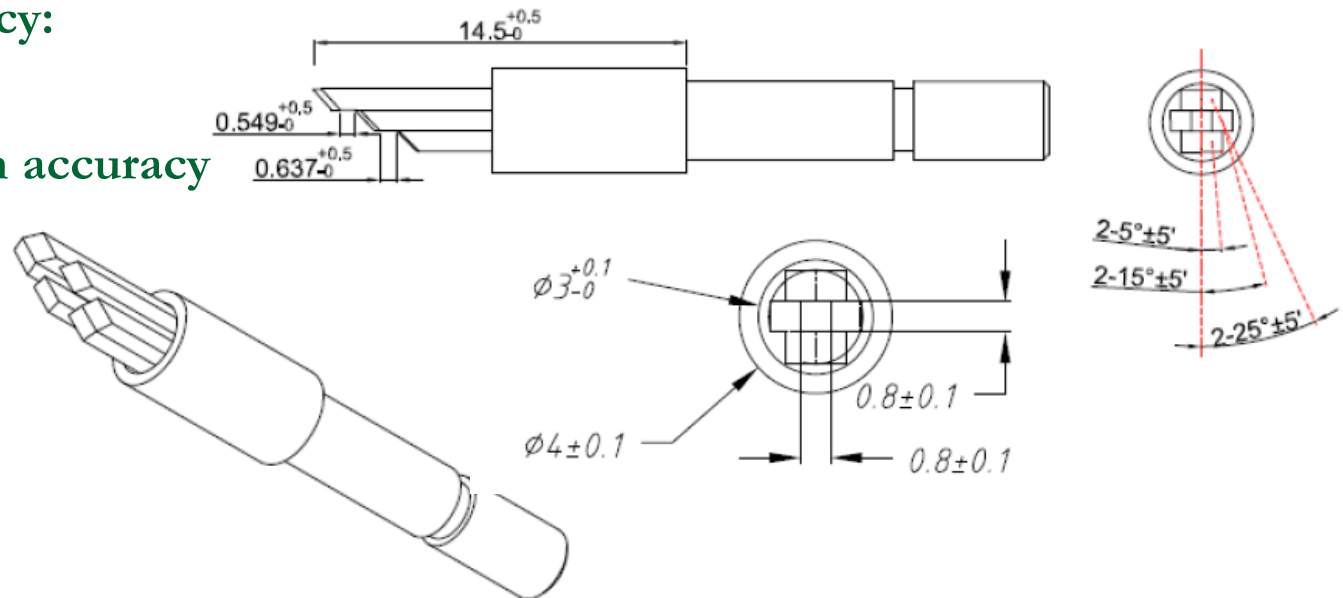
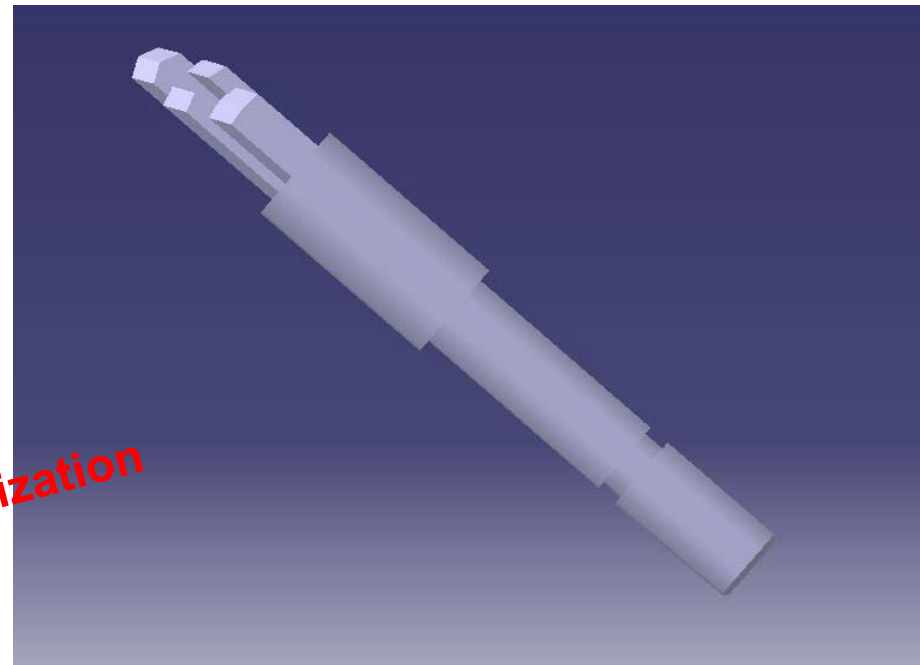

Mirrors test with 266nm

Test:

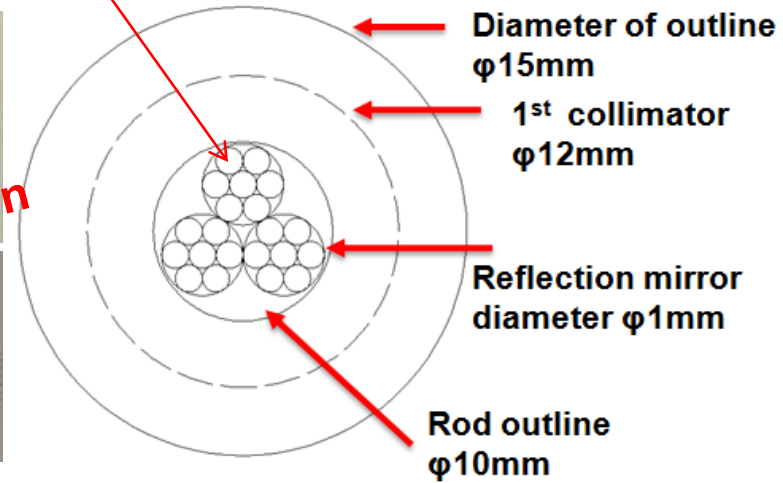
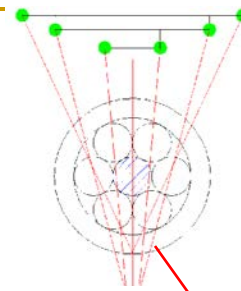
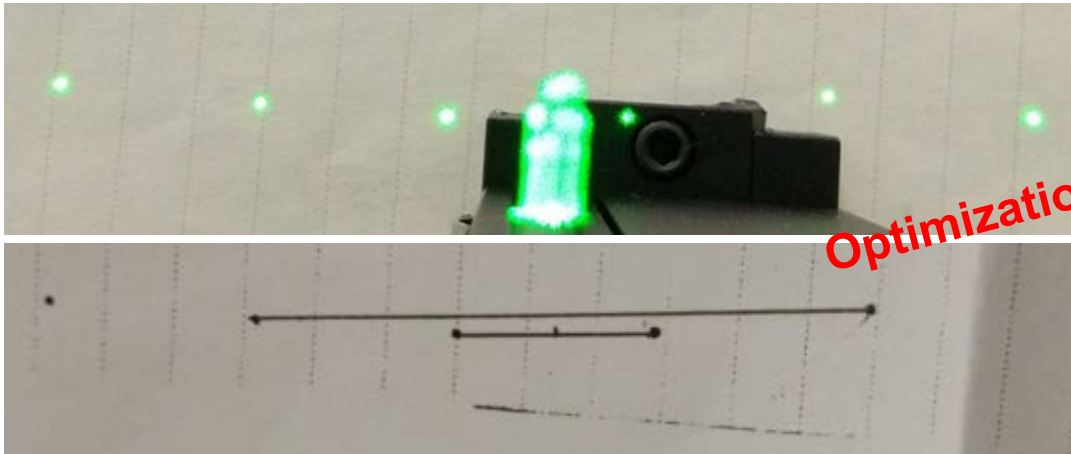

Report of the mirrors:

夹角公差
Reflection mirror

5°角	<5'	合格
15°角	<5'	合格
25°角	<5'	合格

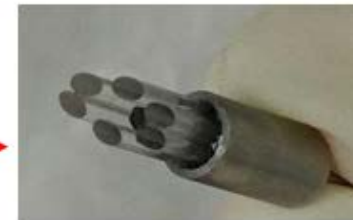
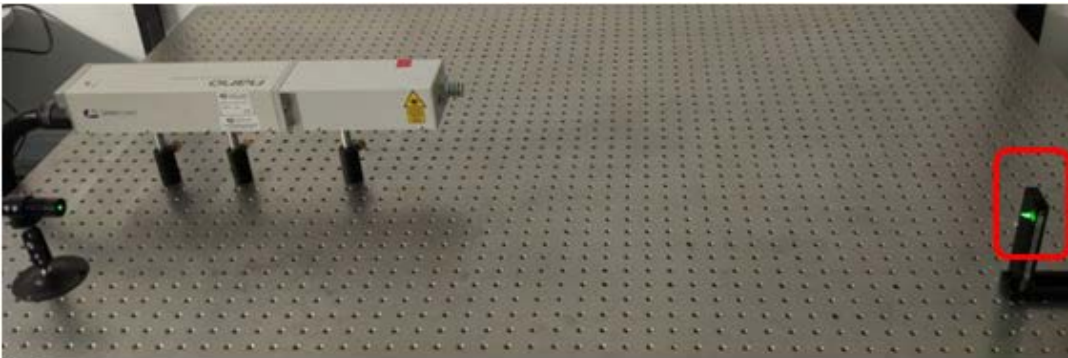

1号	<5'	合格
2号	<5'	合格
3号	<1°	需优化
4号	<10'	需优化
5号	<5'	合格
6号	<5'	合格

Design of the prototype with laser and UV

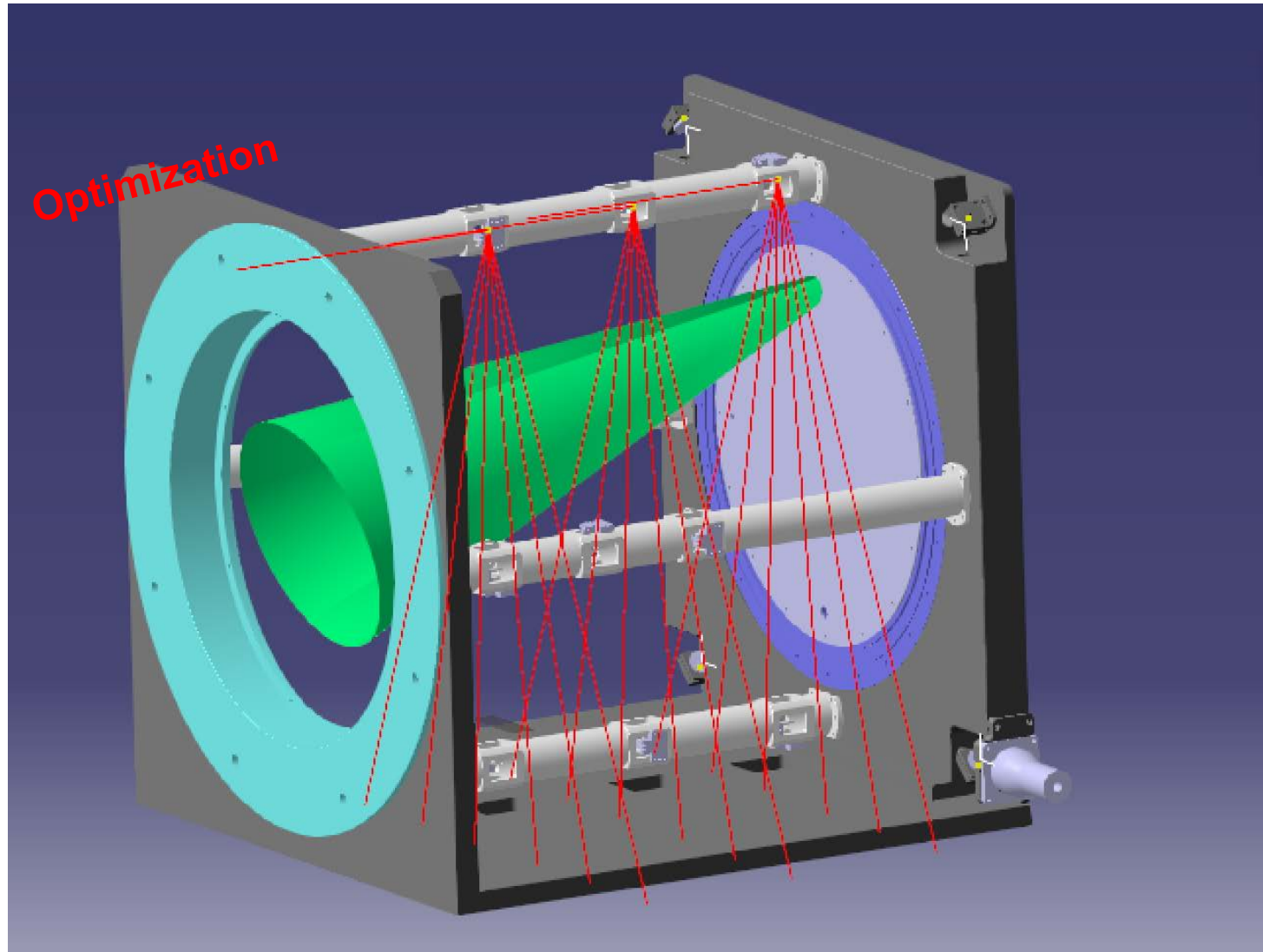

The laser and UV lamp structure without the TPC barrel

Laser map in drift length

- ❑ Laser wave: 266nm
- ❑ Size: $\sim 1\text{mm} \times 1\text{mm}$
- ❑ Transmission and reflection mirrors
- ❑ Aluminum board integrated the laser device and supports

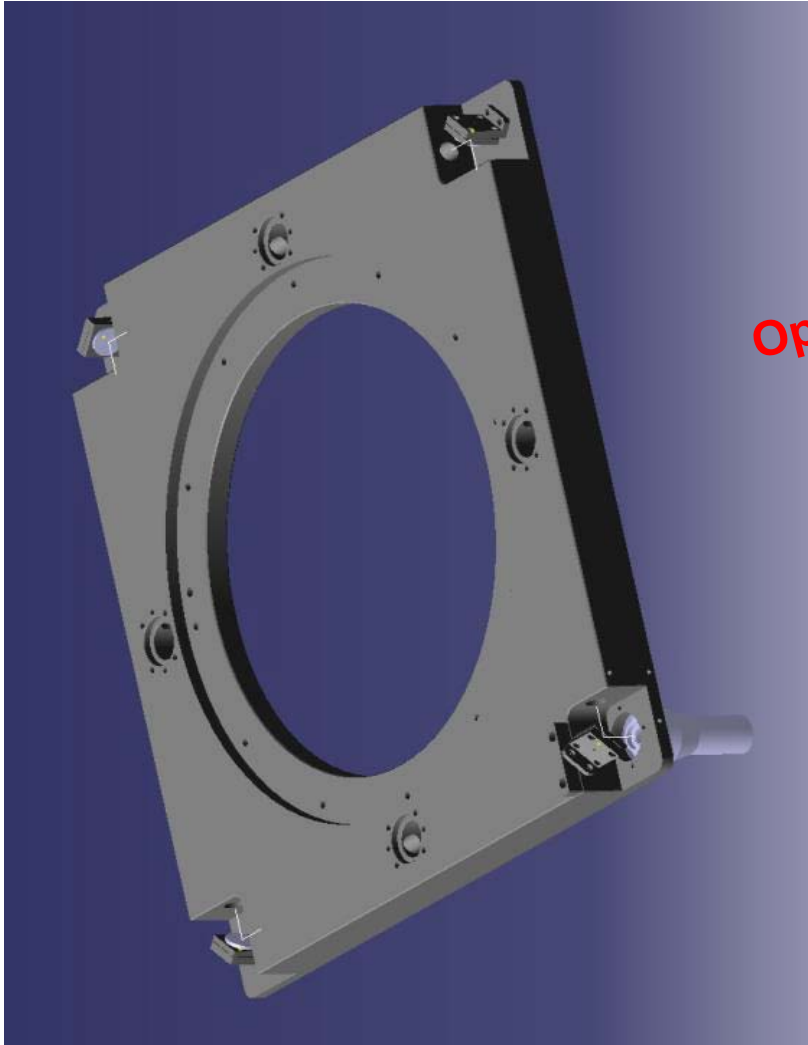

Aluminum board integrated the laser system

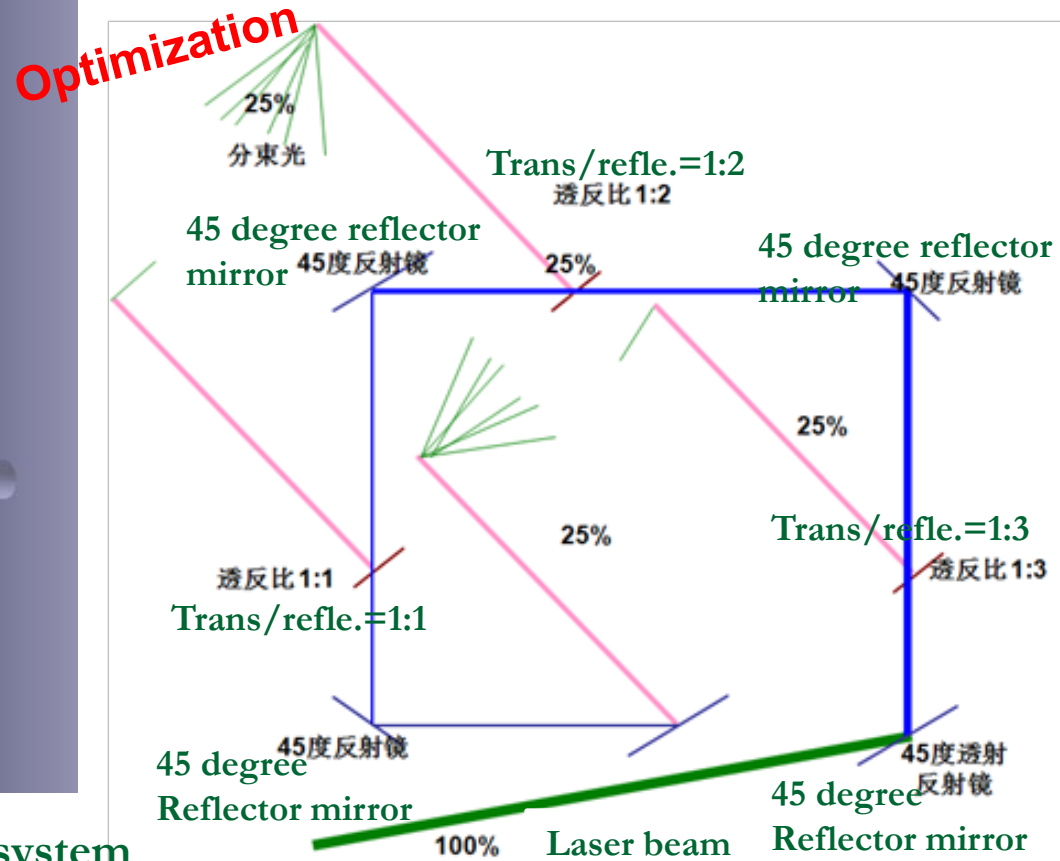

TPC barrel

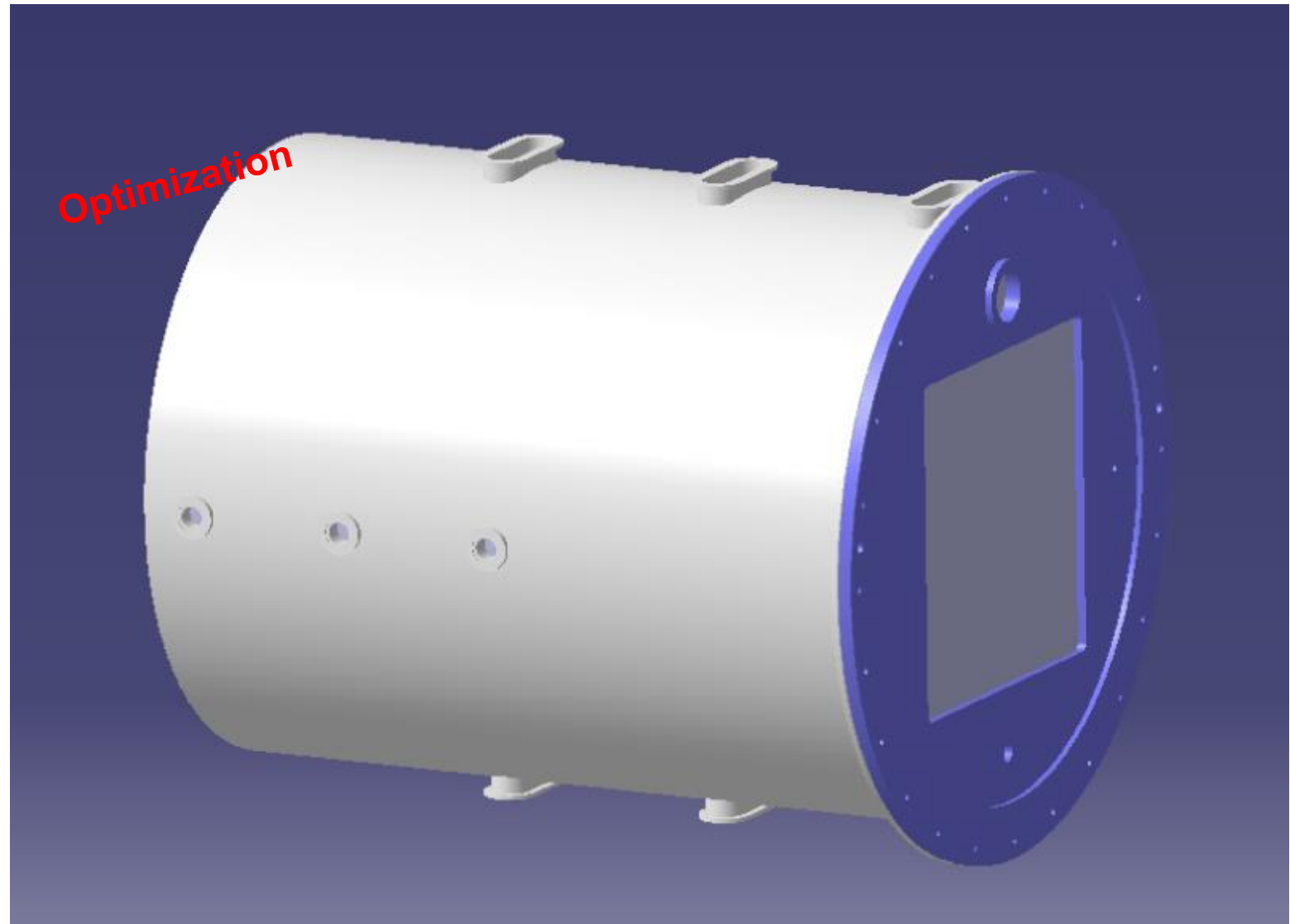

The TPC barrel with the 266nm laser windows

Rod for the mirrors

Optimization

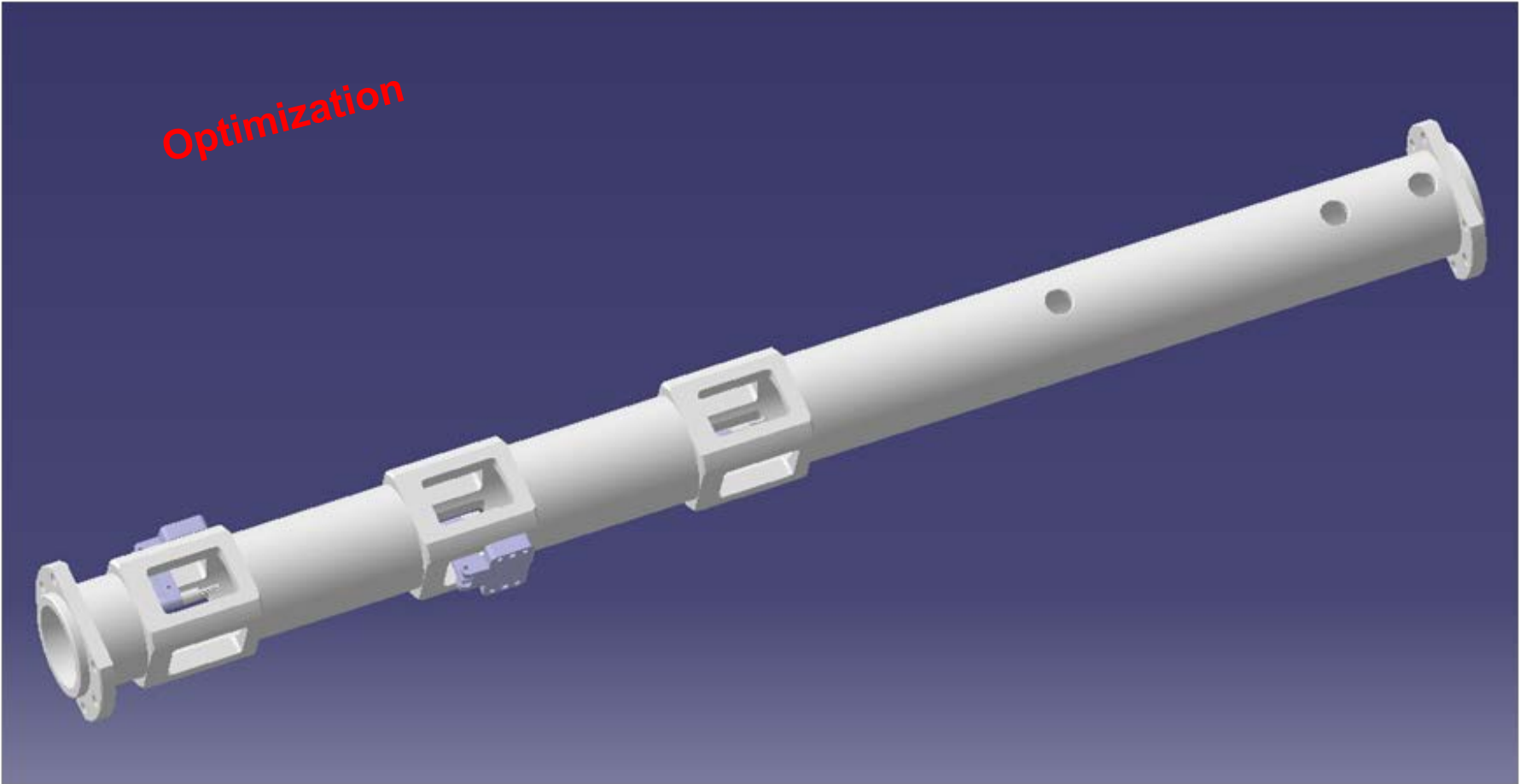

Design of the prototype with laser (Final version)

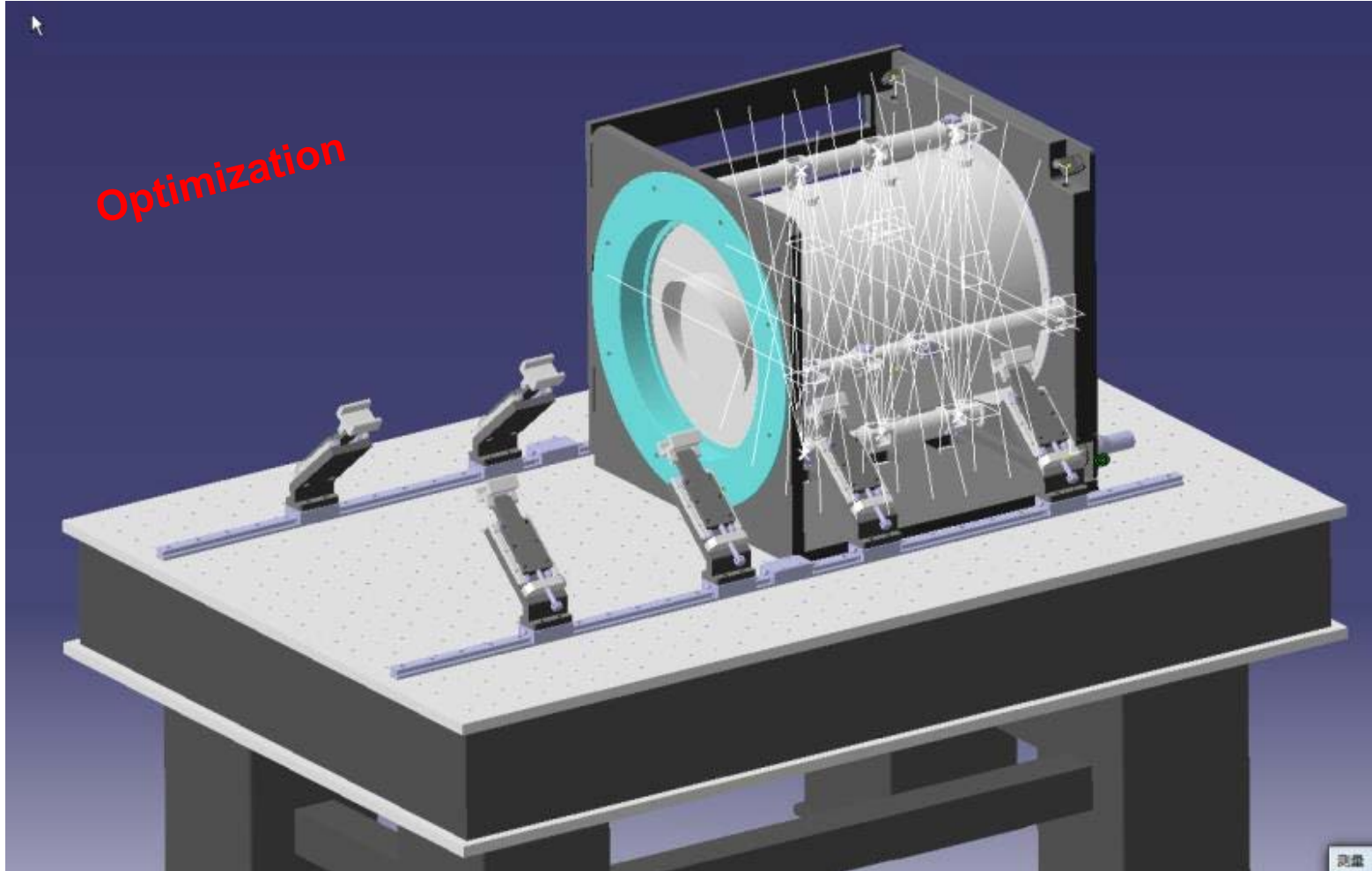

- ❑ Support platform: 1200mm×1500mm (all size as the actual geometry)
- ❑ TPC barrel mount and re-mount with the Auxiliary brackets
- ❑ Design is done and hardware would be assembled the end of this year. - 29 -

Summary

- **Physics requirements for the TPC modules**
 - Continuous Ion Back Flow due to the continuous beam structure
 - Gating device could **NOT** be used due to the limit time
 - Ion back flow is the most critical issue for the TPC module at circular colliders

- **Some activities for the module and prototype**
 - IBF simulation of the detector have been started and further simulated.
 - Some preliminary IBF results of the continuous Ion Backflow suppression detector modules has been analyzed.
 - The design of the prototype integrated with UV and 266nm laser has been done and assembled.

- **R&D work within some collaboration (LC-TPC/CEPC)**

Thanks for your attention!