

希格斯粒子属性的测量

曹庆宏

北京大学物理学院

2018-08-19

The Great Standard Model

(1895 - 2012)

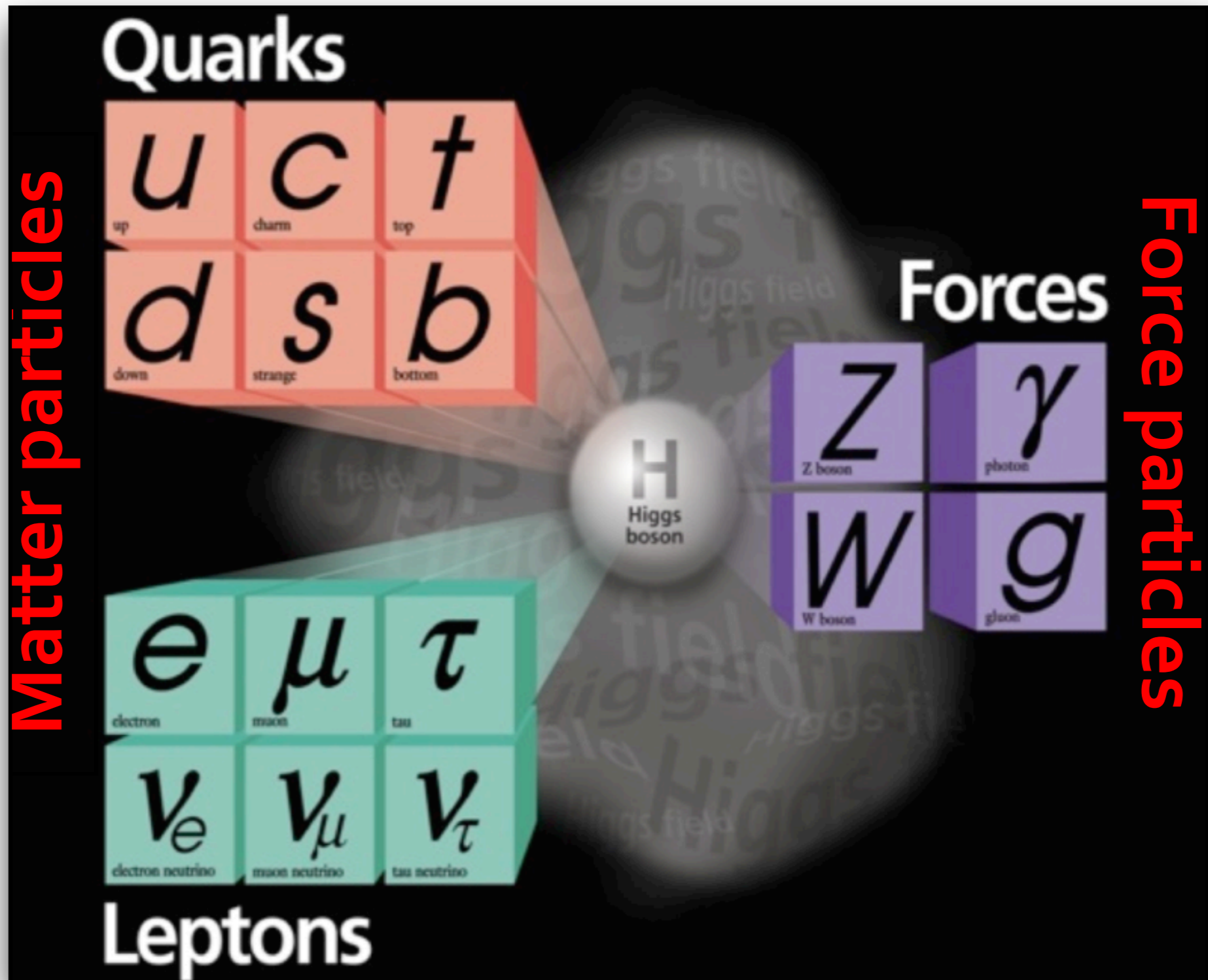

Two outstanding puzzles in SM

Origins of EWSB
(*W/Z Masses*)

and Flavor breaking
(*Fermion Mass*)

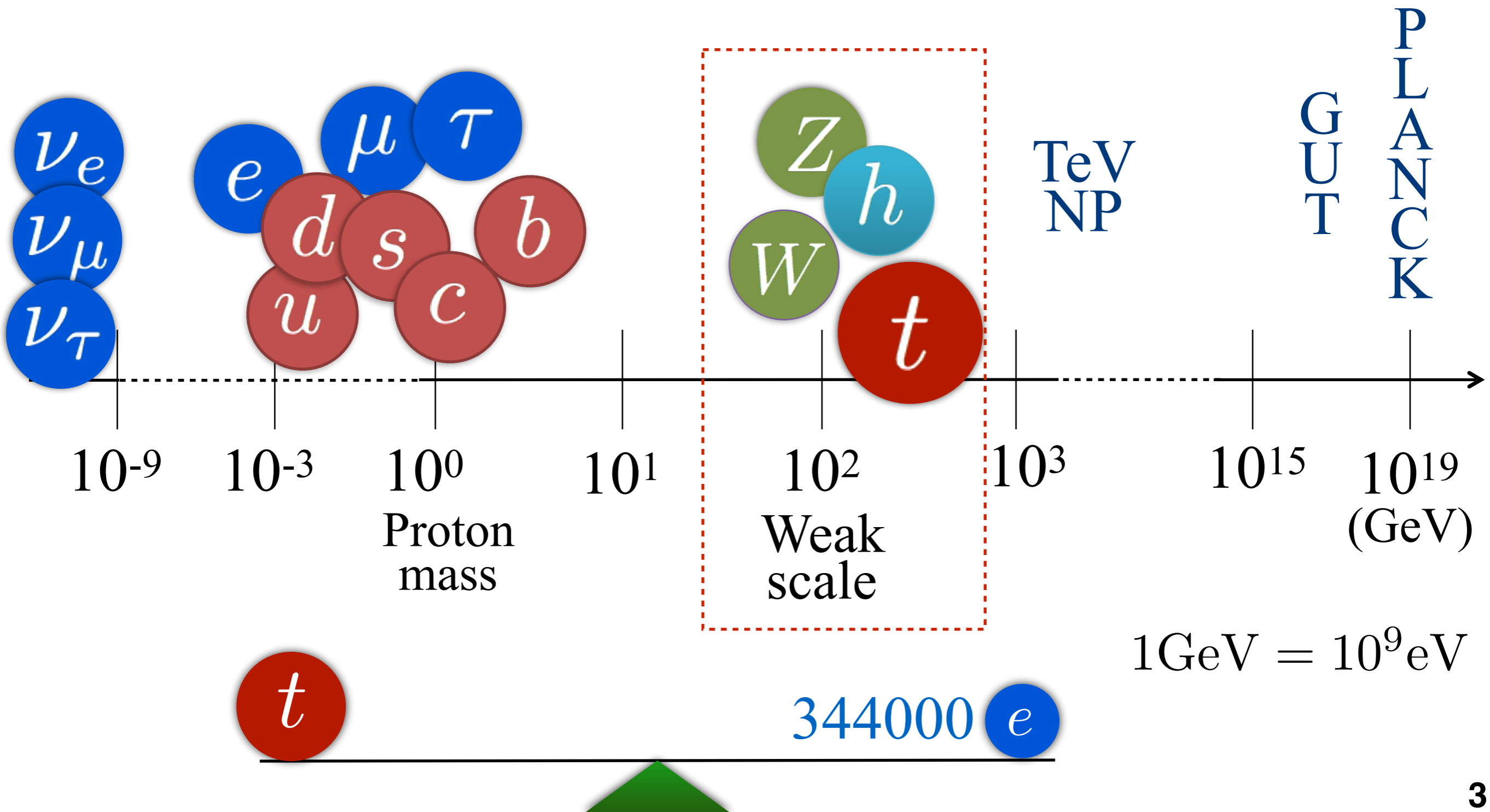

Electroweak Triangle

$$\mathcal{L} = (D_\mu \Phi)^\dagger (D^\mu \Phi) - \mu^2 \Phi^\dagger \Phi + \lambda (\Phi^\dagger \Phi)^2 + y_f \bar{F}_L \Phi f_r + \dots$$

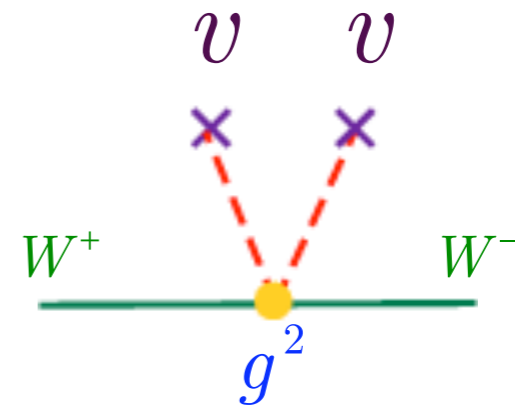
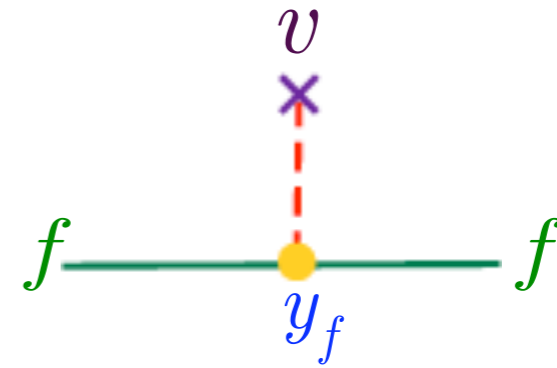
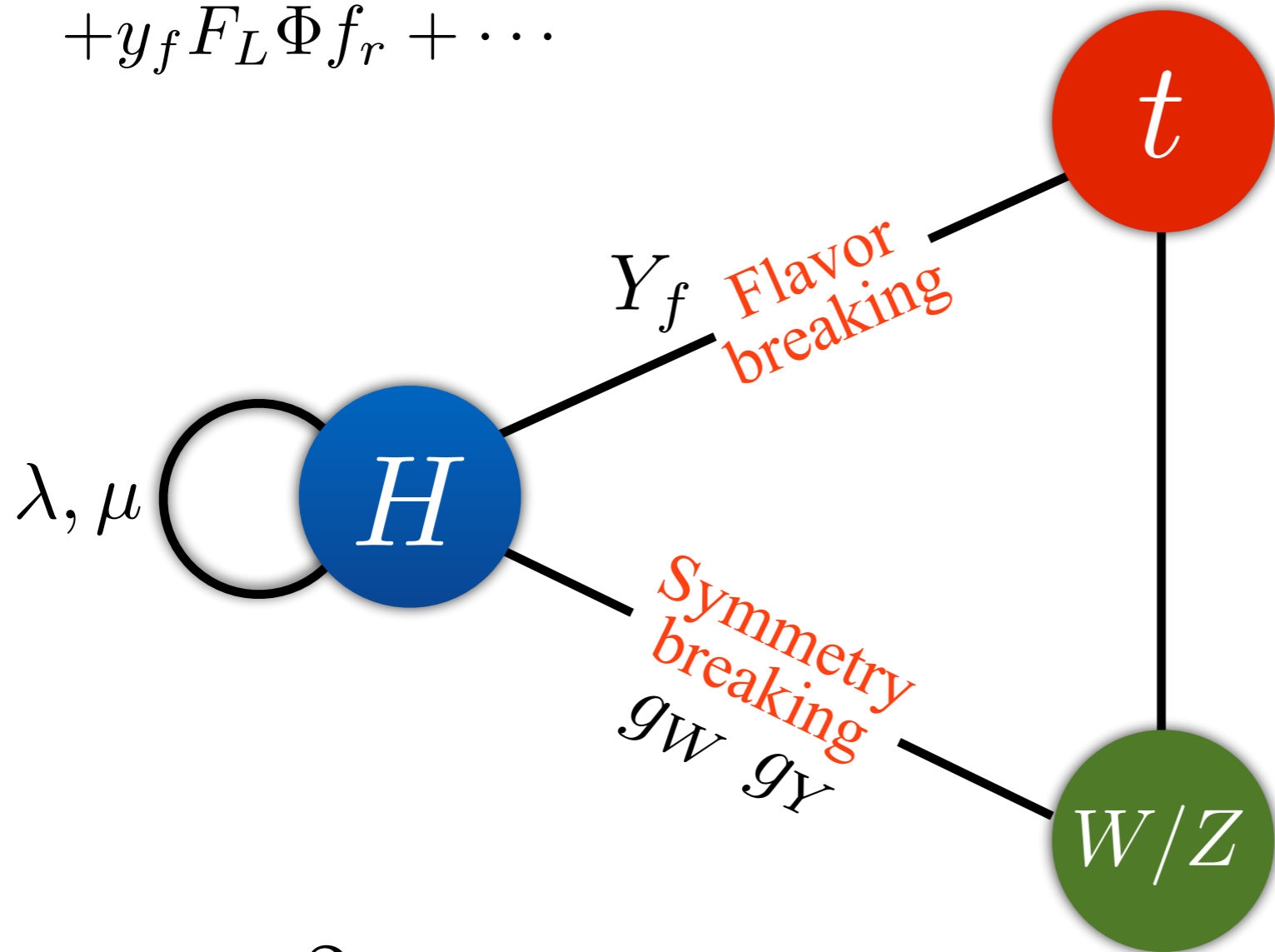

$$m_h^2 = m_t \times m_Z$$

Electroweak Triangle

Spontaneous Electroweak
Symmetry Breaking

Massive W -Boson

Existence of longitudinal
 W -boson W_L

Study interaction of
 $W_L W_L \rightarrow W_L W_L$
in the TeV region

Goldstone
Equivalence
Theorem

W_L can also interact strongly
with top quark as

$$m_t = \frac{v}{\sqrt{2}} = 174 \text{ GeV}$$

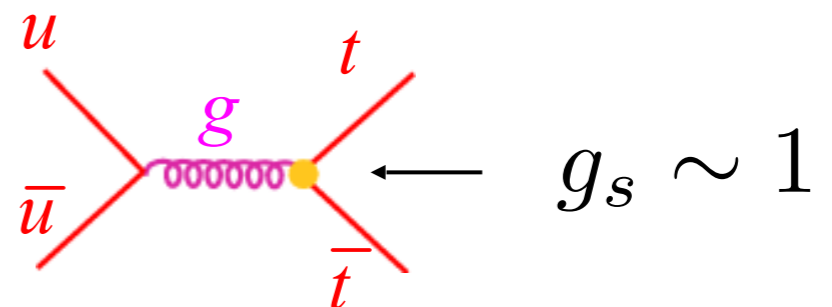
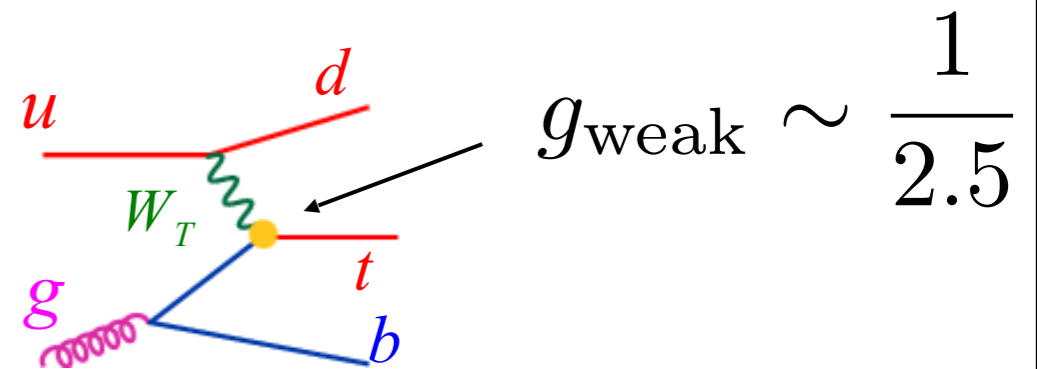
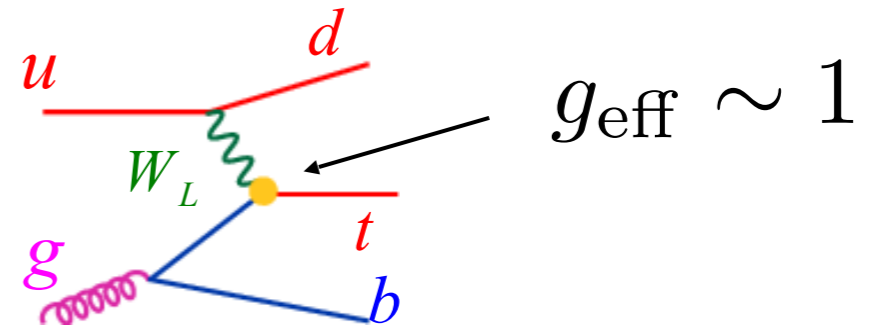

Electroweak Triangle

$$\mathcal{L} = (D_\mu \Phi)^\dagger (D^\mu \Phi) - \mu^2 \Phi^\dagger \Phi + \lambda (\Phi^\dagger \Phi)^2 + y_f \bar{F}_L \Phi f_r + \dots$$

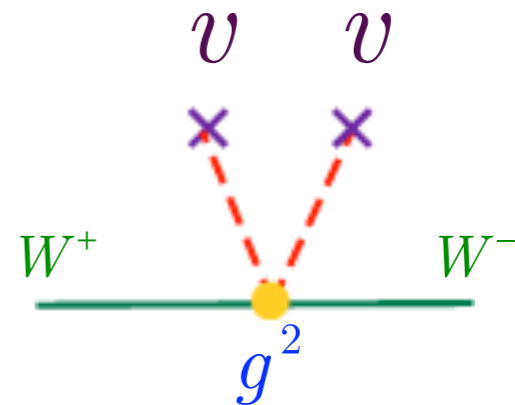
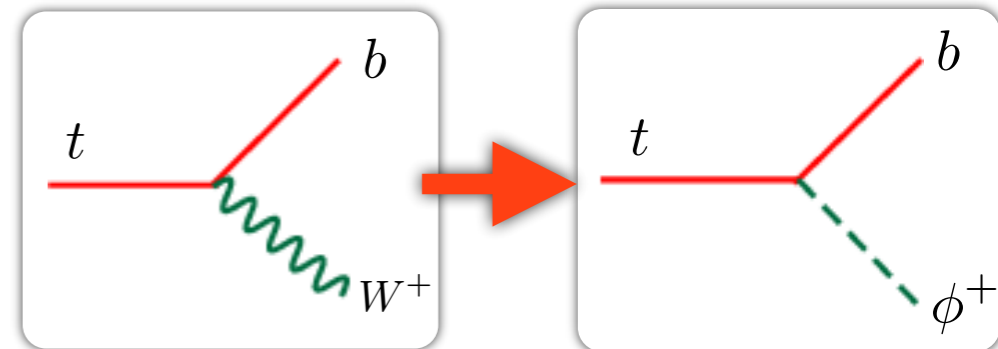
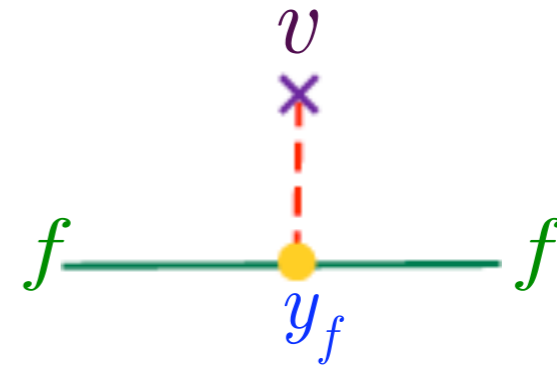
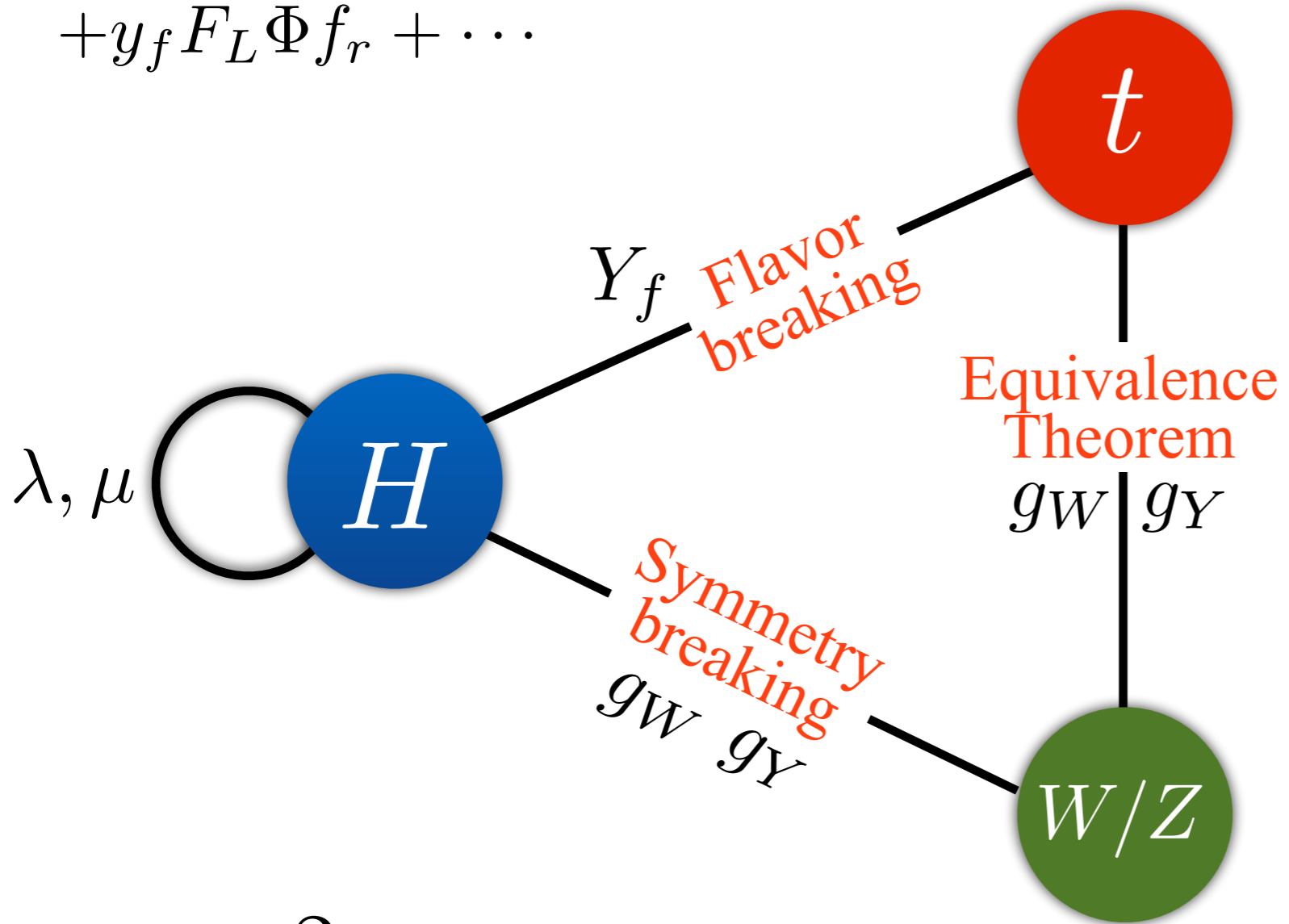

$$m_h^2 = m_t \times m_Z$$

What can Higgs Boson tell us?

HVV coupling

Relation between
 M_W and M_Z
(custodial Symmetry)

Relation between
HVV and HHVV
couplings

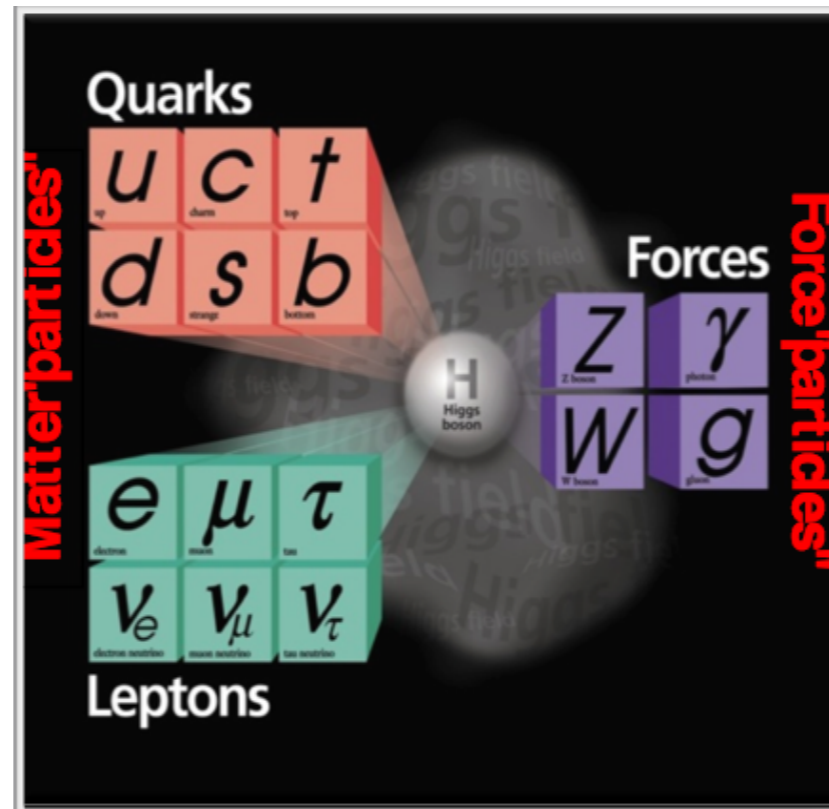

HFF coupling

Magnitude and CP

Higgs-self couplings
HHH and HHHH

The Higgs boson is important not only for **EWSB**,
but also as a **WINDOW to NP** beyond the SM.

1) Higgs-self Interaction

(probing potential at electroweak scale)

$$V(\phi) = -\mu^2\phi^2 + \lambda(\mu)\phi^4 + \frac{\kappa(\mu)}{\Lambda^2}\phi^6 + \dots$$

Coleman-Weinberg Higgs

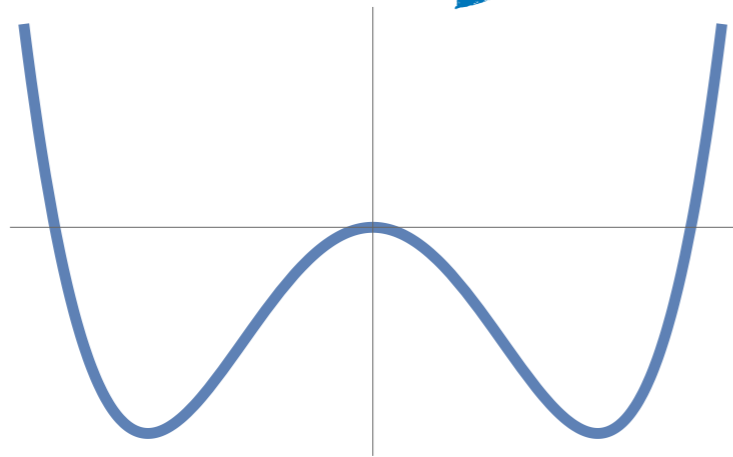

$$V(\phi) = \lambda(\phi^\dagger\phi)^2 + \epsilon(\phi^\dagger\phi)^2 \log \frac{\phi^\dagger\phi}{\mu^2}$$

Pseudo-Goldstone Higgs

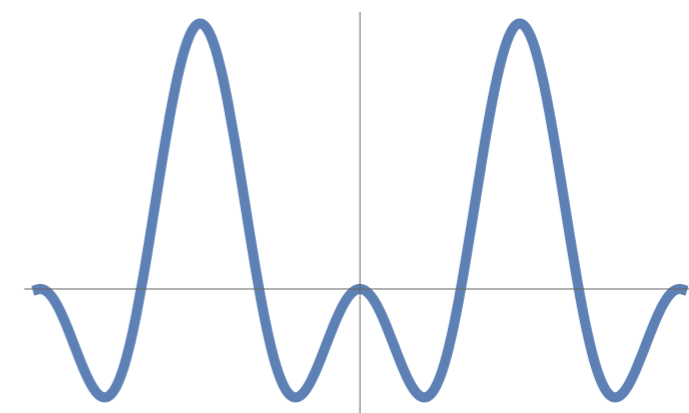

$$V(\phi) = a \sin^2(\phi/f) + b \sin^4(\phi/f)$$

1) Higgs-self Interaction

(probing potential at electroweak scale)

$$V(\phi) = -\mu^2\phi^2 + \lambda(\mu)\phi^4 + \frac{\kappa(\mu)}{\Lambda^2}\phi^6 + \dots$$

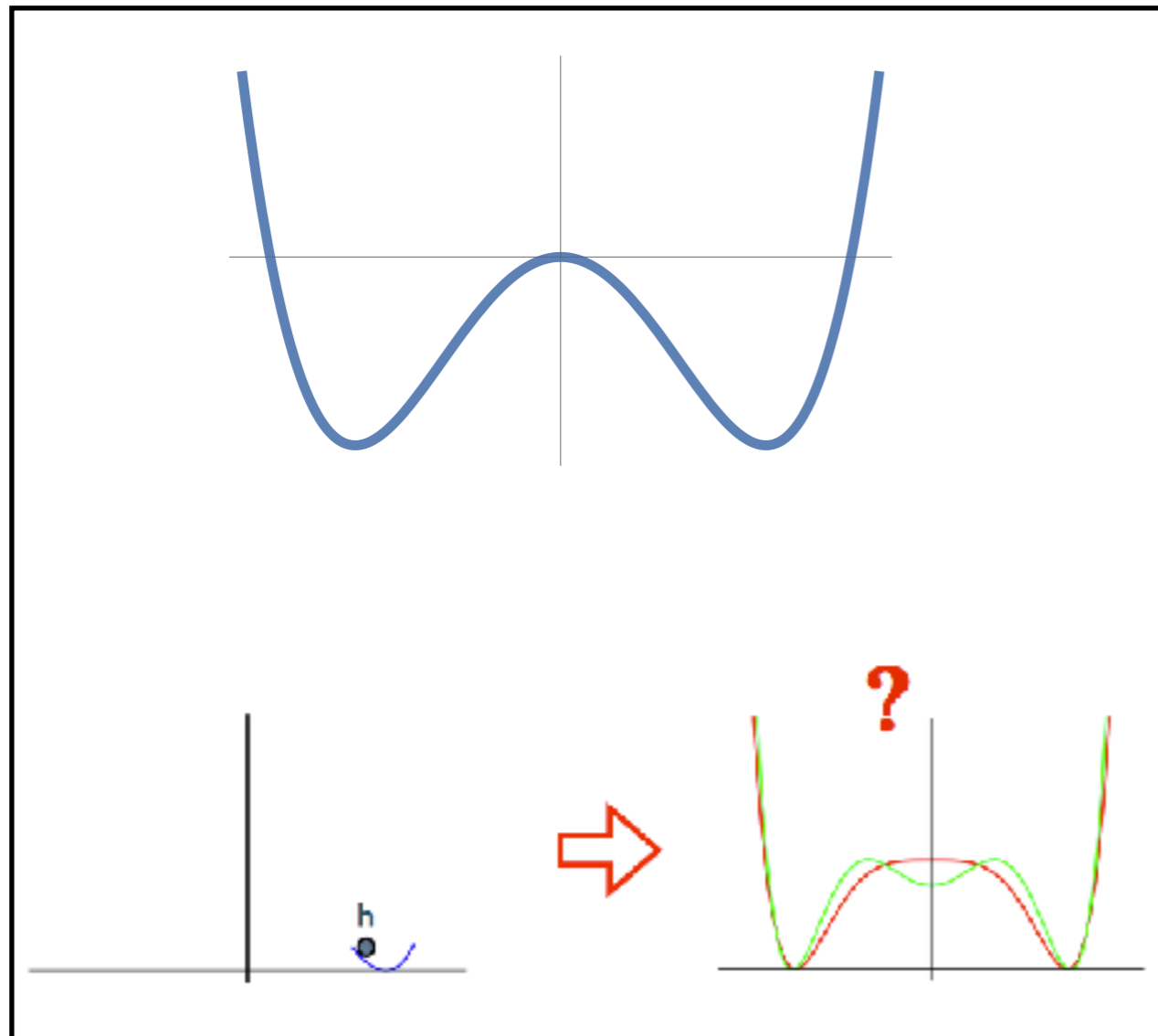

Higgs pair production

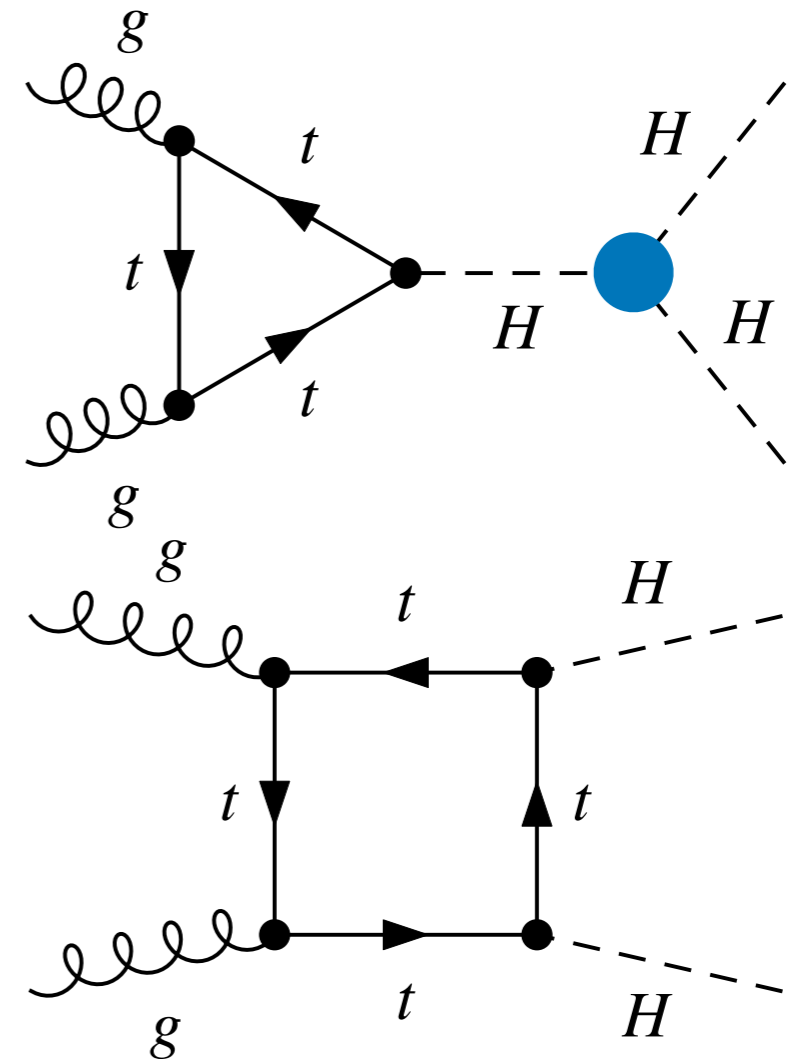

2) HVV versus HHV

SM predicts a definite **ratio** between HVV and HHV couplings

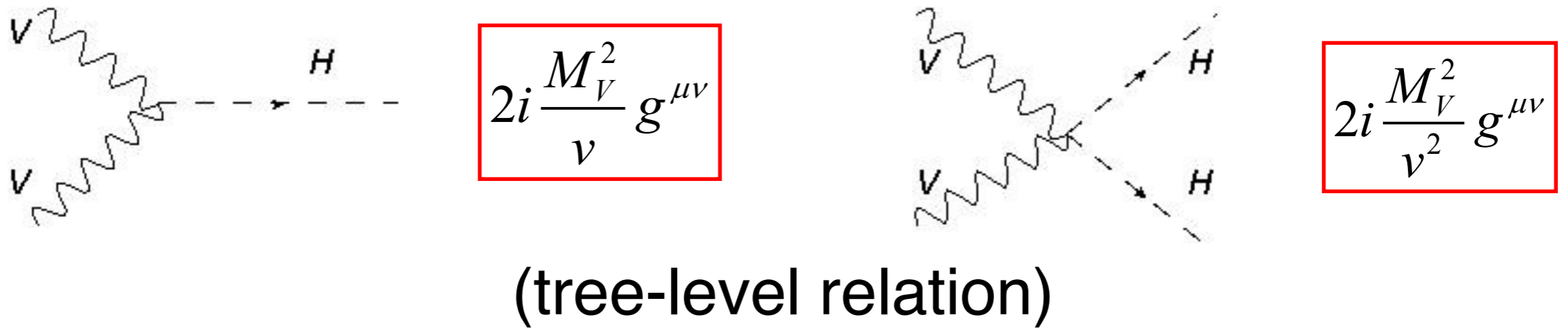

If the ratio is modified by NP, the unitarity of VV->HH is broken

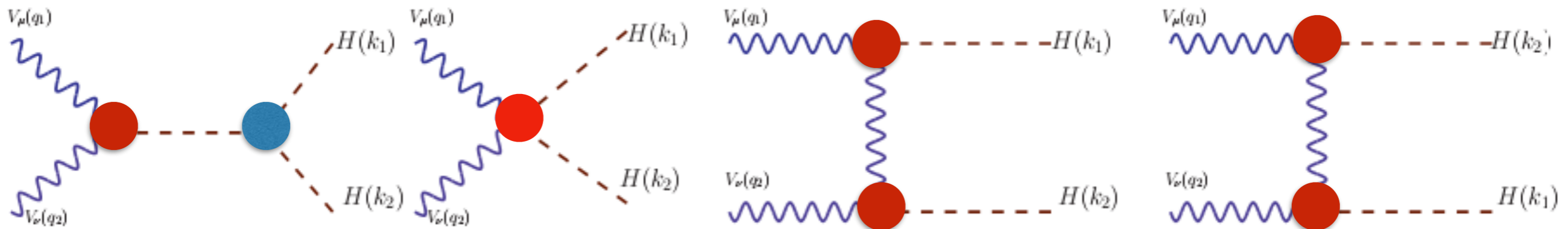

Higgs Boson Pair Production

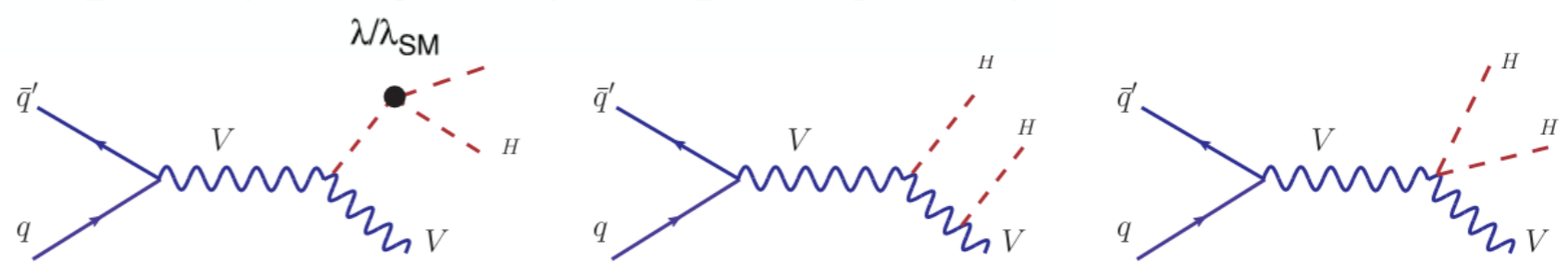
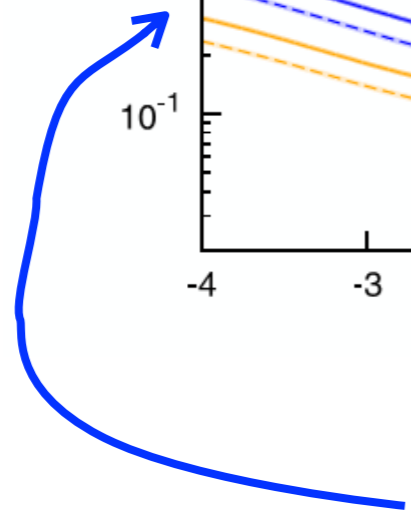
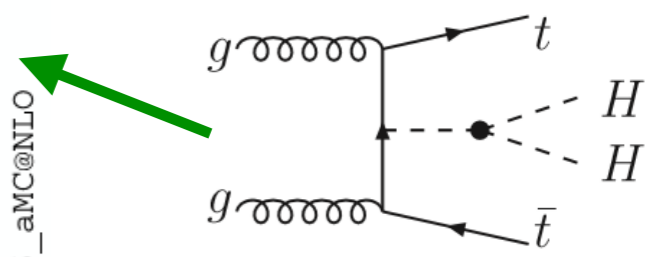
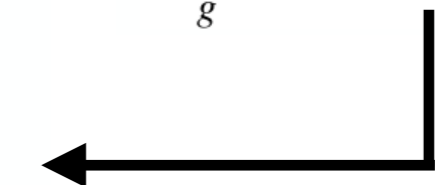
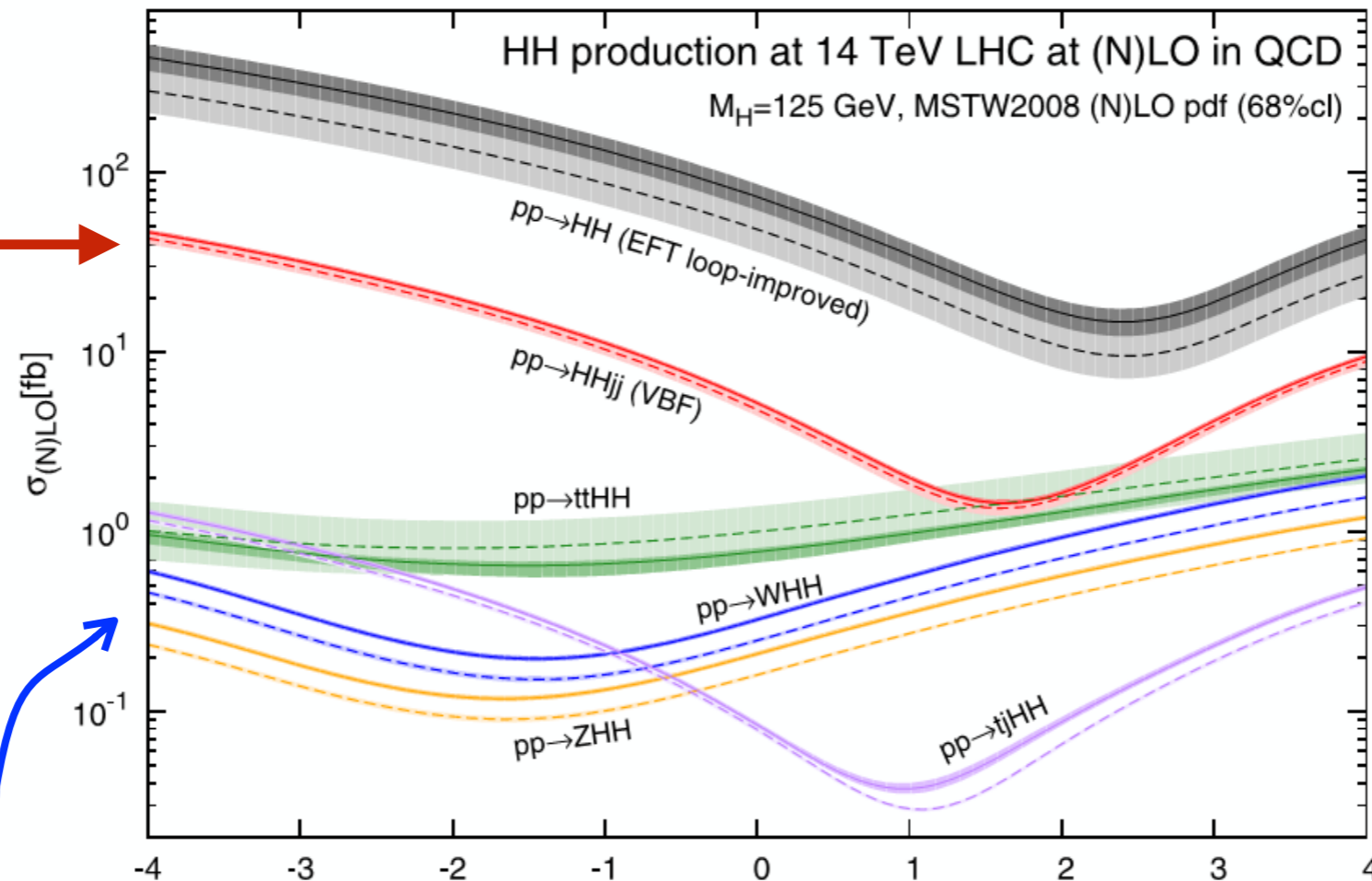
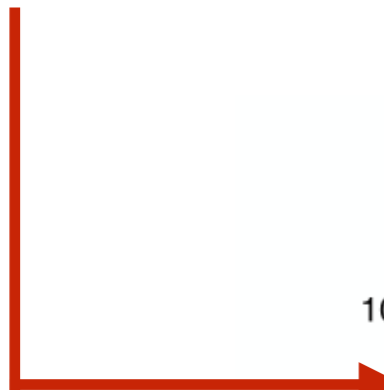
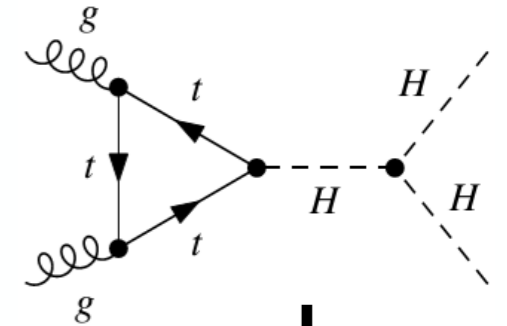
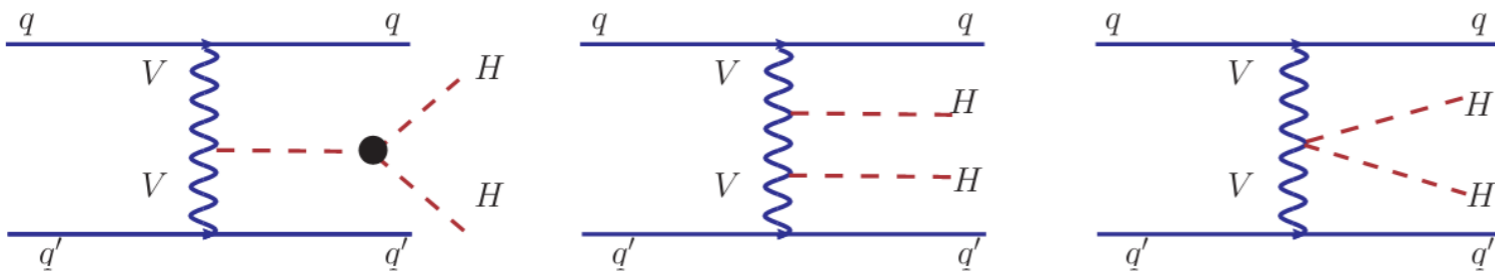

Sensitivity to HHH coupling

$gg \rightarrow HH$: the leading channel

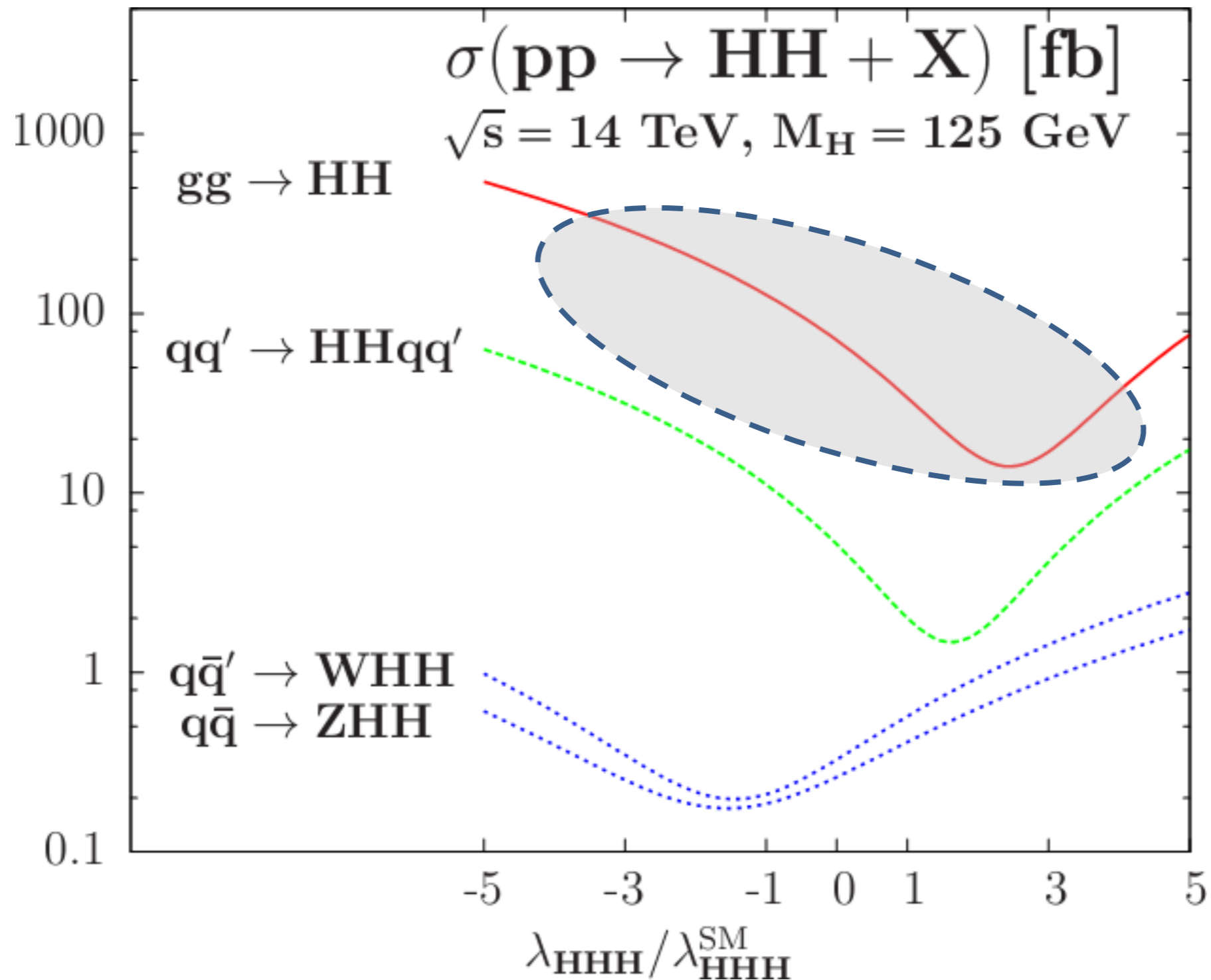

Sensitivity to HHH coupling

gg->HH: the leading channel

Low-energy theorem (Dawson and Haber, 1989)

Strong cancelation

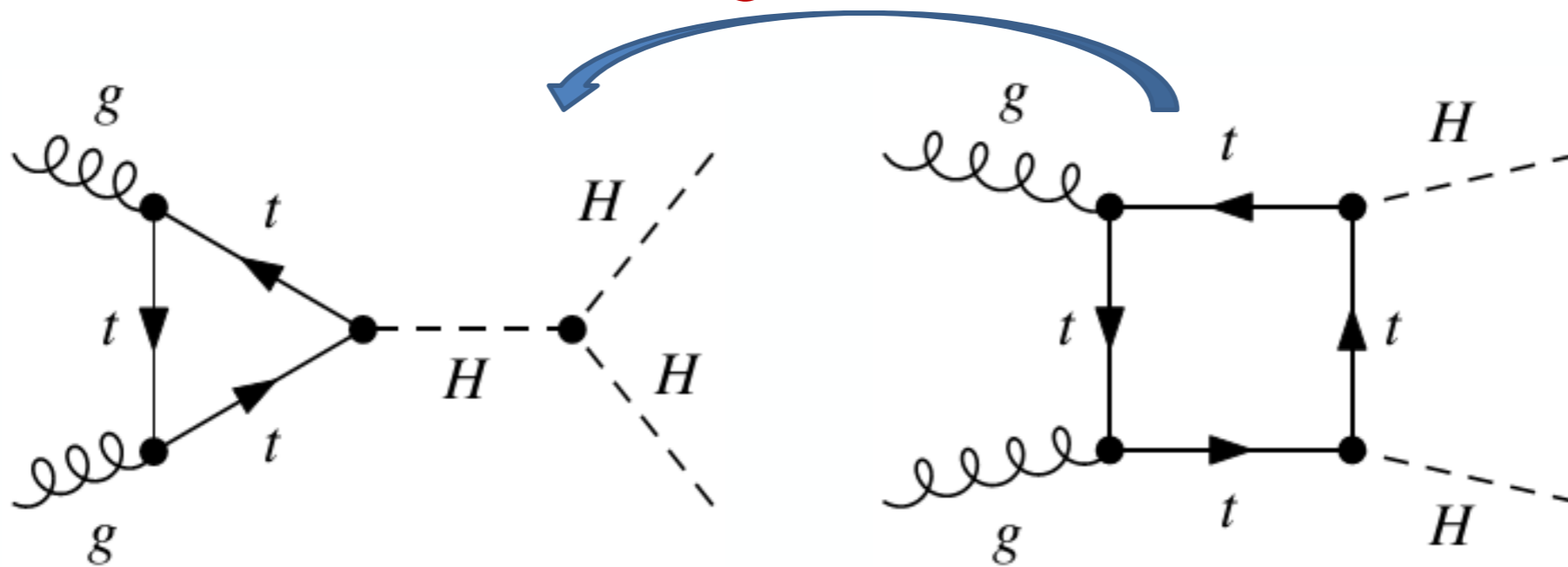

$$-\frac{\alpha_s}{24\pi} G^{a,\mu\nu} G_{\mu\nu}^a \sum_n \frac{y_t^n h^n}{n!} \frac{\partial^n}{\partial m_t^n} \log \left(\frac{\Lambda_{UV}^2}{m_t^2} \right)$$

n=1

$$\frac{\alpha_s}{12\pi v} G^{a,\mu\nu} G_{\mu\nu}^a h$$

n=2

$$-\frac{\alpha_s}{24\pi v^2} G^{a,\mu\nu} G_{\mu\nu}^a h^2$$

Sensitivity to HHH coupling

$gg \rightarrow HH$: the leading channel

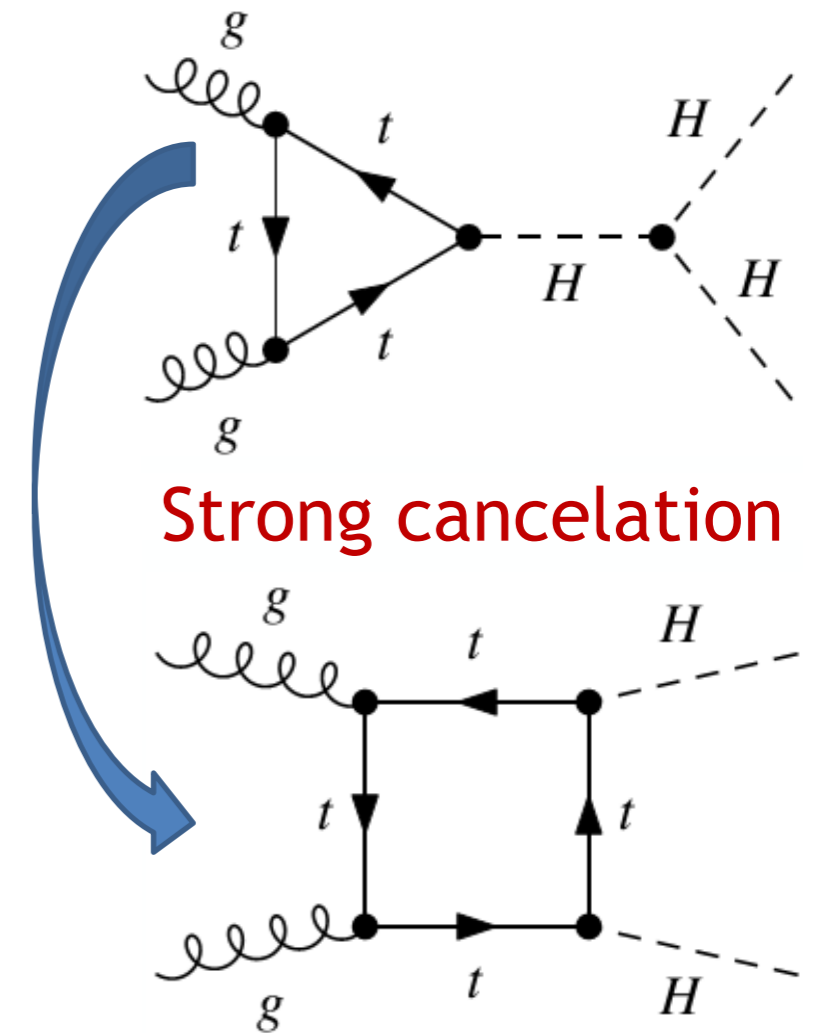
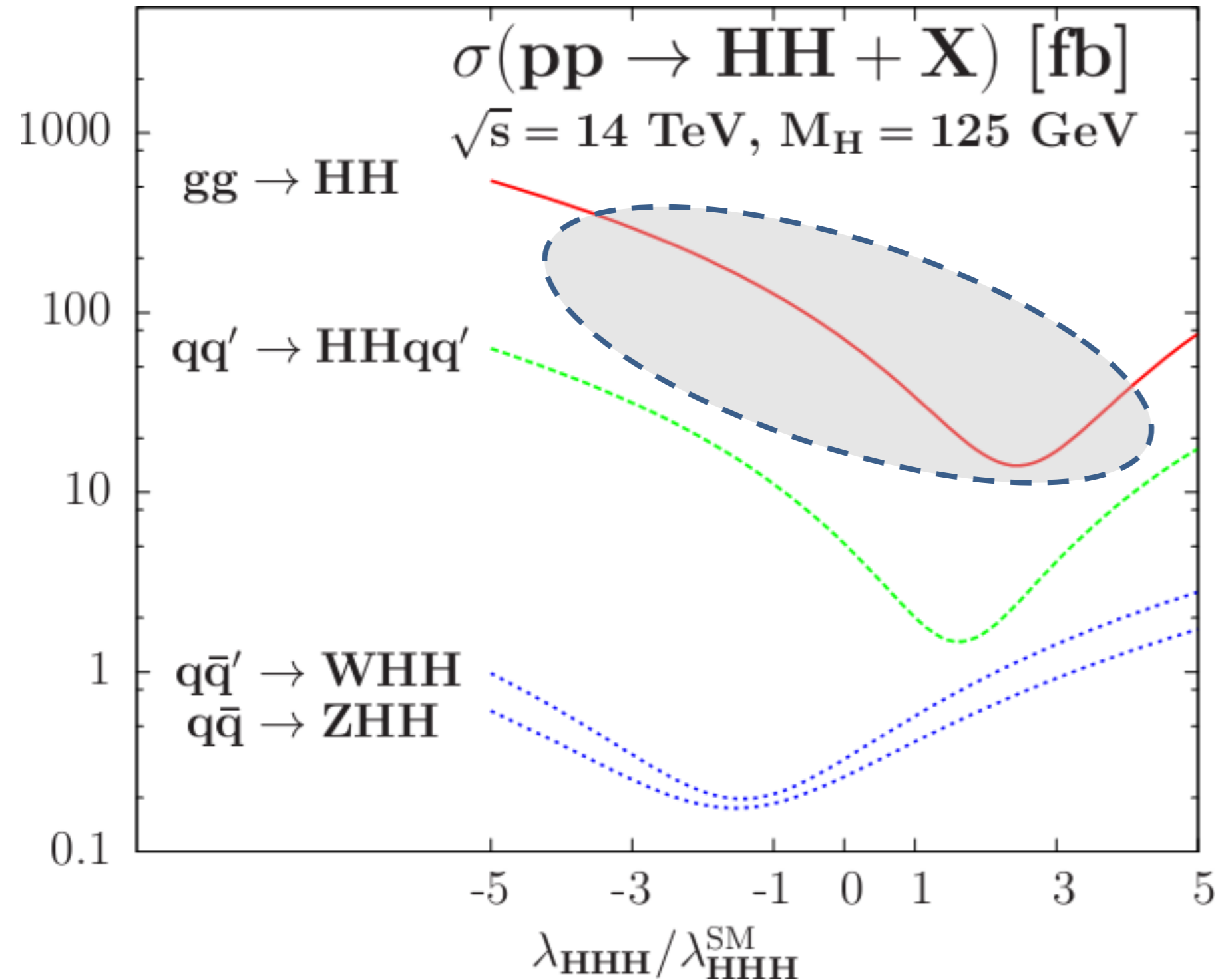

**Low Energy
Theorem**

gg->HH: the leading channel

Unfortunately, it is not a easy job at the LHC or even at the SppC.

HH production

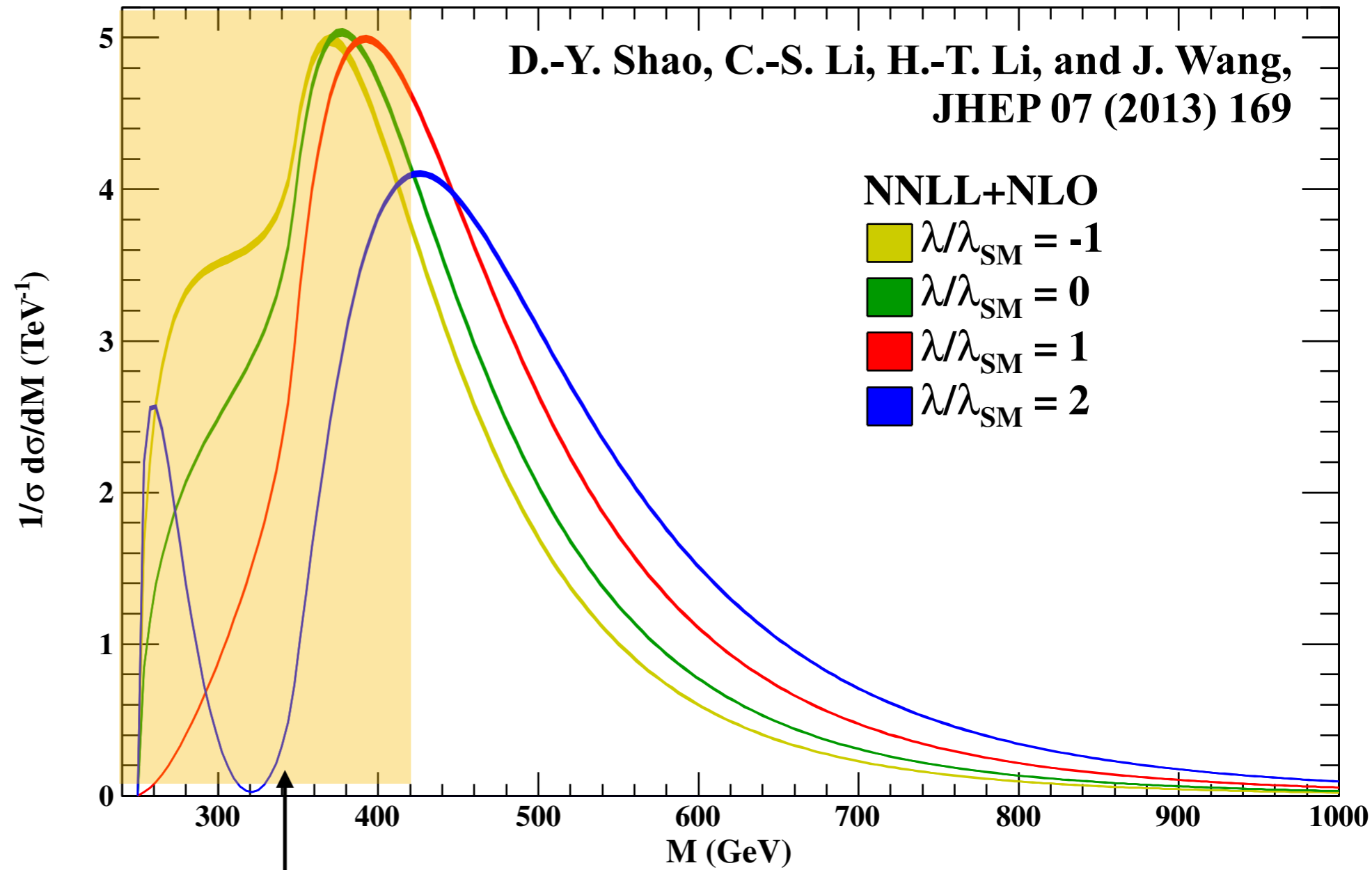
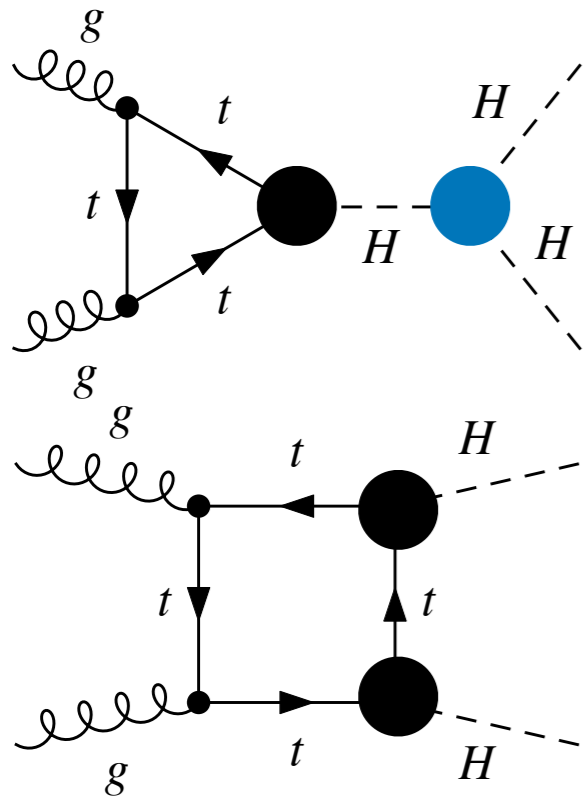

Not accessible at detector!

Too many things involved in $gg \rightarrow HH \rightarrow b\bar{b}\gamma\gamma$

$$\mathcal{L}_{\text{eff}} = -\frac{m_t}{v}\bar{t}(c_t + i\tilde{c}_t\gamma_5)th - \frac{m_t}{2v^2}\bar{t}(c_{2t} + i\tilde{c}_{2t}\gamma_5)th^2 + \frac{\alpha_s h}{12\pi v}(c_g G_{\mu\nu}^A G^{A,\mu\nu} + \tilde{c}_g G_{\mu\nu}^A \tilde{G}^{A,\mu\nu})$$

$$+ \frac{\alpha_s h^2}{24\pi v^2}(c_{2g} G_{\mu\nu}^A G^{A,\mu\nu} + \tilde{c}_{2g} G_{\mu\nu}^A \tilde{G}^{A,\mu\nu}) - c_{3h} \frac{m_h^2}{2v} h^3,$$

**QHC, Li, Yan, Zhang, Zhang,
Phys.Rev. D96 (2017) no.9, 095031**

$$\begin{aligned} \mu_{hh} = & A_1 c_{3h}^2 c_g^2 + A_2 c_{3h}^2 c_g c_t + A_3 c_{3h}^2 c_t^2 + A_4 c_{3h} c_g c_{2g} + A_5 c_{3h} c_g c_t^2 + A_6 c_{3h} c_{2g} c_t + A_7 c_{3h} c_g \tilde{c}_t^2 \\ & + A_8 c_{3h} c_t^3 + A_9 c_{3h} c_t \tilde{c}_t^2 + A_{10} c_{2g}^2 + A_{11} c_{2g} c_t^2 + A_{12} c_g \tilde{c}_t^2 + A_{13} c_t^4 + A_{14} c_t^2 \tilde{c}_t^2 + A_{15} \tilde{c}_t^4 \\ & + A_{16} c_{3h}^2 \tilde{c}_g^2 + A_{17} c_{3h}^2 \tilde{c}_g \tilde{c}_t + A_{18} c_{3h}^2 \tilde{c}_t^2 + A_{19} c_{3h} \tilde{c}_g \tilde{c}_{2g} + A_{20} c_{3h} \tilde{c}_g c_t \tilde{c}_t + A_{21} c_{3h} \tilde{c}_{2g} \tilde{c}_t \\ & + A_{22} \tilde{c}_{2g}^2 + A_{23} \tilde{c}_{2g} c_t \tilde{c}_t + A_{24} c_{2t}^2 + A_{25} c_{2t} c_{3h} c_g + A_{26} c_{2t} c_{3h} c_t + A_{27} c_{2t} c_{2g} + A_{28} c_{2t} c_t^2 \\ & + A_{29} c_{2t} \tilde{c}_t^2 + A_{30} c_t \tilde{c}_t \tilde{c}_{2t} + A_{31} c_{3h} \tilde{c}_t \tilde{c}_{2t} + A_{32} c_{3h} \tilde{c}_g \tilde{c}_{2t} + A_{33} \tilde{c}_{2t}^2 + A_{34} \tilde{c}_g \tilde{c}_{2t}. \end{aligned}$$

\sqrt{s}	A_1	A_2	A_3	A_4	A_5	A_6	A_7	A_8	A_9	A_{10}	A_{11}	A_{12}
14 TeV	0.138	0.370	0.276	0.640	-0.766	0.821	0.535	-1.35	-6.22	1.37	-1.82	1.58
100 TeV	0.101	0.267	0.208	0.592	-0.569	0.658	0.425	-1.11	-4.79	3.32	-1.30	1.67
\sqrt{s}	A_{13}	A_{14}	A_{15}	A_{16}	A_{17}	A_{18}	A_{19}	A_{20}	A_{21}	A_{22}	A_{23}	A_{24}
14 TeV	2.07	13.9	0.719	0.138	-0.611	0.861	0.640	2.13	-1.24	1.37	4.64	2.55
100 TeV	1.90	11.3	0.680	0.101	-0.428	0.634	0.592	1.53	-0.928	3.32	3.51	2.90
\sqrt{s}	A_{25}	A_{26}	A_{27}	A_{28}	A_{29}	A_{30}	A_{31}	A_{32}	A_{33}	A_{34}		
14 TeV	0.821	1.39	2.44	-4.24	2.30	-18.8	4.04	-1.24	6.19	-3.02		
100 TeV	0.658	1.21	2.06	-4.13	2.16	-16.3	3.28	-0.928	6.10	-2.08		

Sensitivity to HHH coupling:

2) VBF and VHH

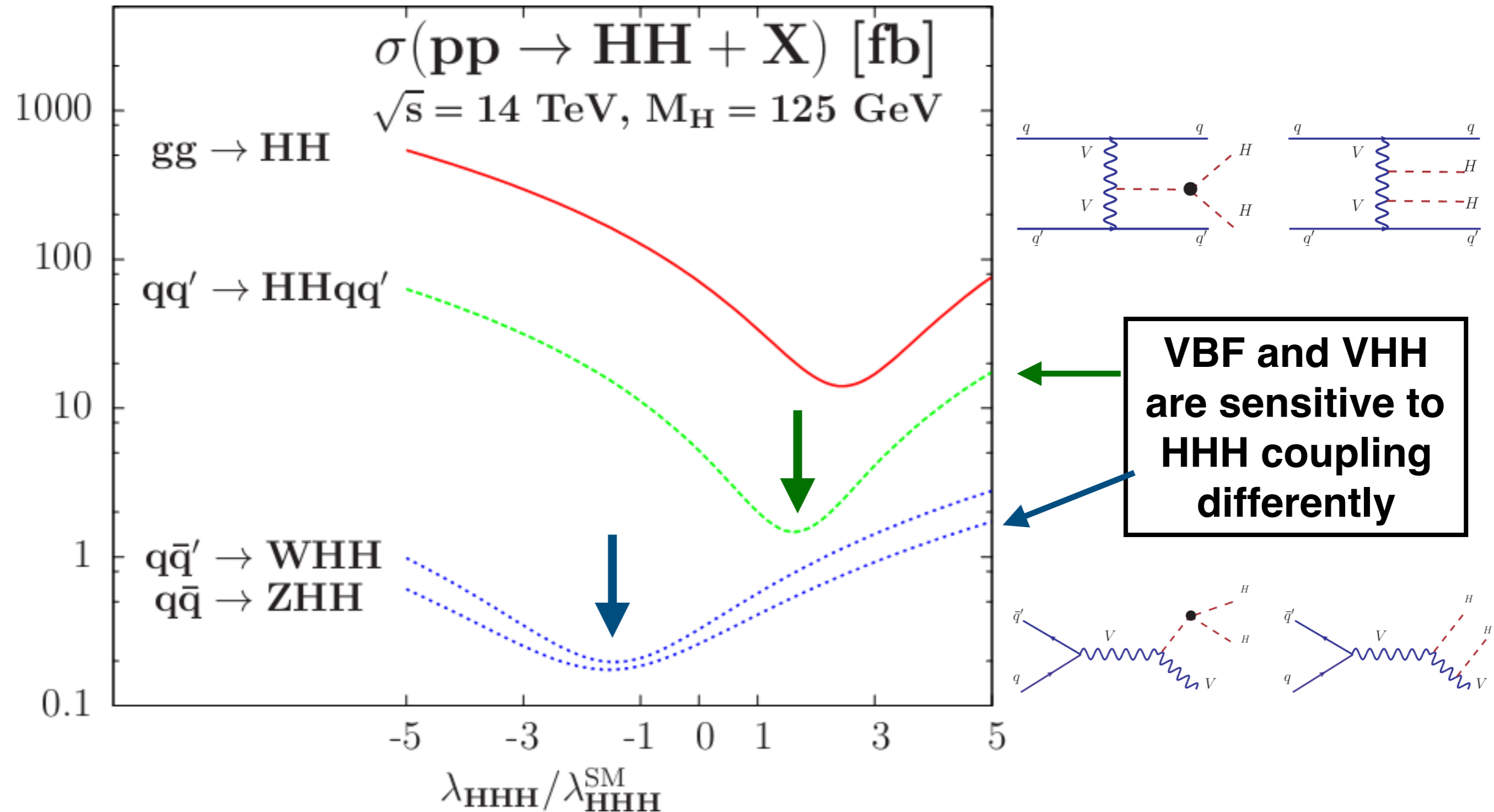

Sensitive to Triple Higgs Coupling Differently

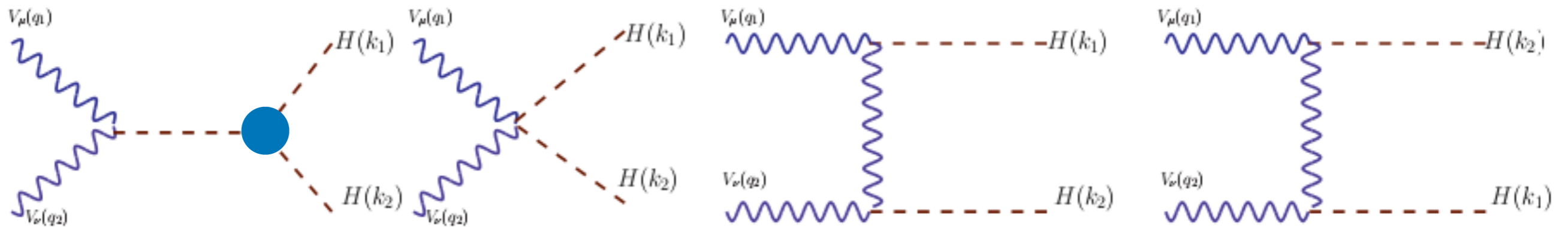

$$M^{\mu\nu} = \left[\frac{m_W^2}{v^2} \frac{6m_H^2}{\hat{s} - m_H^2} \frac{\lambda_{HHH}}{\lambda_{HHH}^{\text{SM}}} + \frac{2m_W^2}{v^2} + \frac{4m_W^4}{v^2} \left(\frac{1}{\hat{t} - m_W^2} + \frac{1}{\hat{u} - m_W^2} \right) \right] g^{\mu\nu} + \dots$$

Near the threshold of Higgs-boson pairs

VBF:

$$\hat{t} = \hat{u} = Q^2 < 0$$

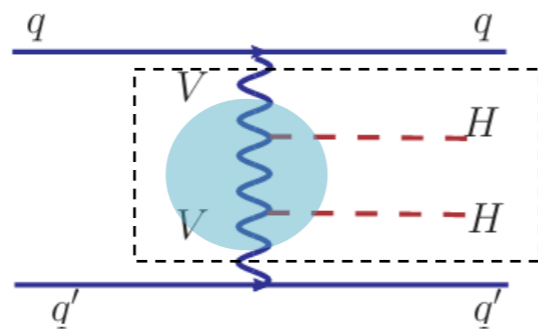

$$M^{\mu\nu} \sim \frac{2m_V^2}{v^2} \left(\frac{\lambda_{HHH}}{\lambda_{HHH}^{\text{SM}}} - 3 \right) g^{\mu\nu} + \dots$$

VHH:

$$\hat{t} = \hat{u} = Q^2 > 0$$

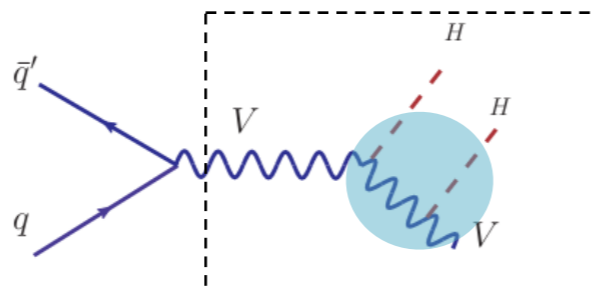

$$M^{\mu\nu} \sim \frac{2m_V^2}{v^2} \left(\frac{\lambda_{HHH}}{\lambda_{HHH}^{\text{SM}}} + 1 \right) g^{\mu\nu} + \dots$$

Sensitivity to HHH Coupling

VBF $M^{\mu\nu} \sim \frac{2m_V^2}{v^2} \left(\frac{\lambda_{HHH}}{\lambda_{HHH}^{\text{SM}}} - 3 \right) g^{\mu\nu} + \dots$

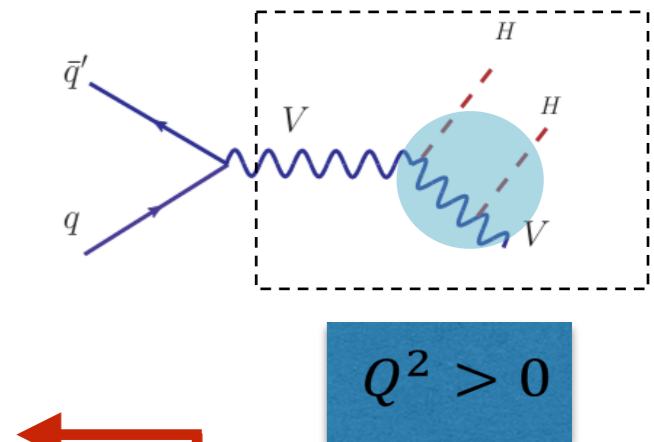
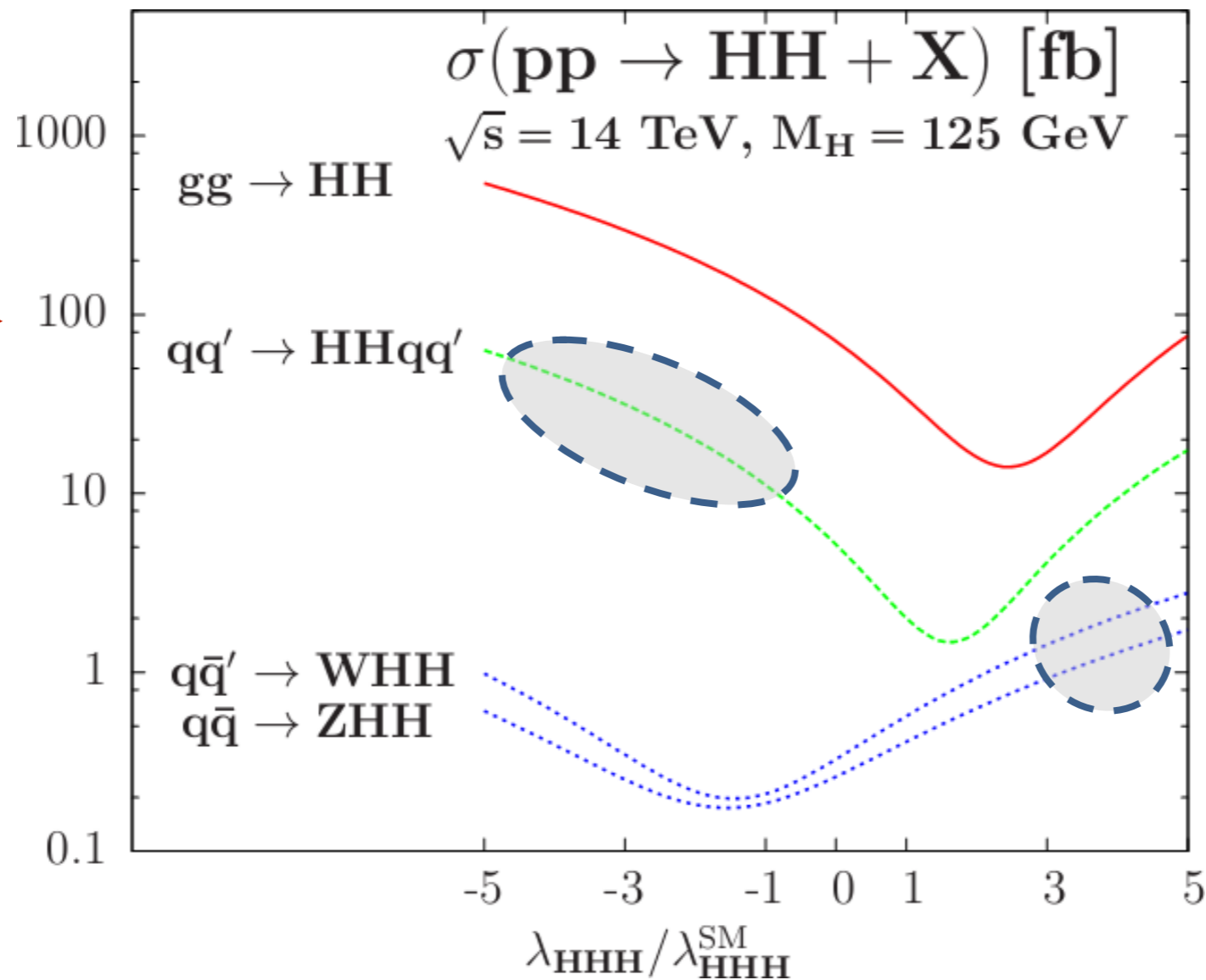
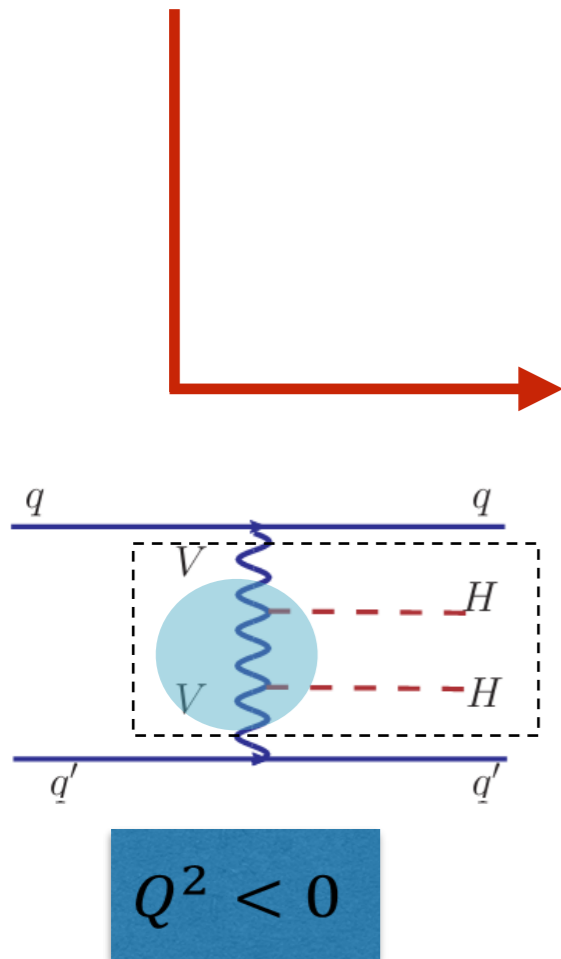

VHH $M^{\mu\nu} \sim \frac{2m_V^2}{v^2} \left(\frac{\lambda_{HHH}}{\lambda_{HHH}^{\text{SM}}} + 1 \right) g^{\mu\nu} + \dots$

HH and VHH @14 TeV LHC

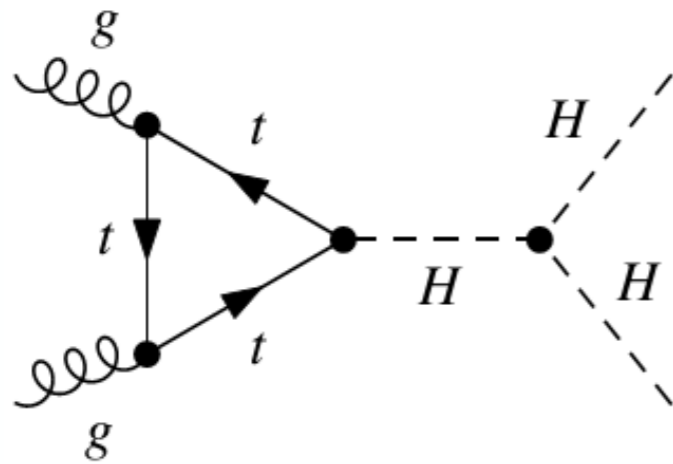

Cross section: 34 fb

VS

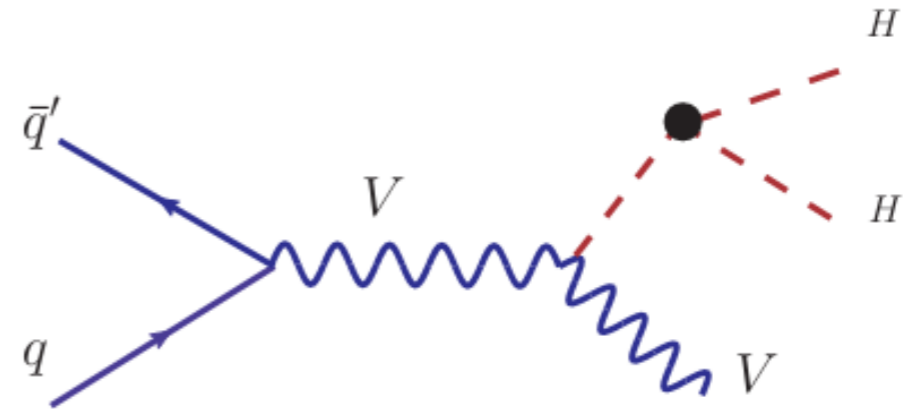

Cross section: 0.57 fb

>>

Final states: $bb\gamma\gamma$

$$Br(bb\gamma\gamma) = 1.3 \times 10^{-3}$$

Final states: $bbbb$

$$Br(bbbb\nu) = 0.073$$

$$\sigma \times Br(bb\gamma\gamma) = 0.044 \text{ fb}$$

\approx

$$\sigma \times Br(bbbb\nu) = 0.042 \text{ fb}$$

Huge backgrounds:

$b\bar{b}\gamma\gamma, c\bar{c}\gamma\gamma, b\bar{b}\gamma j, jj\gamma\gamma,$
 $b\bar{b}jj, t\bar{t}, t\bar{t}\gamma, ZH, t\bar{t}H$

Main backgrounds:

$Zbbbb, Wbbbb, t\bar{t}, t\bar{t}j,$
 $t\bar{t}H, t\bar{t}z, t\bar{t}bb$

VBF and WHH @14 TeV LHC

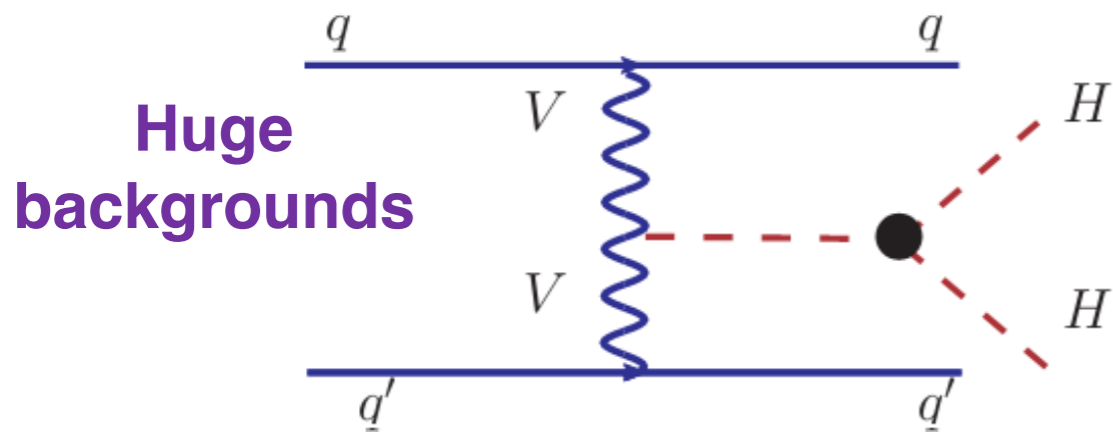

VS

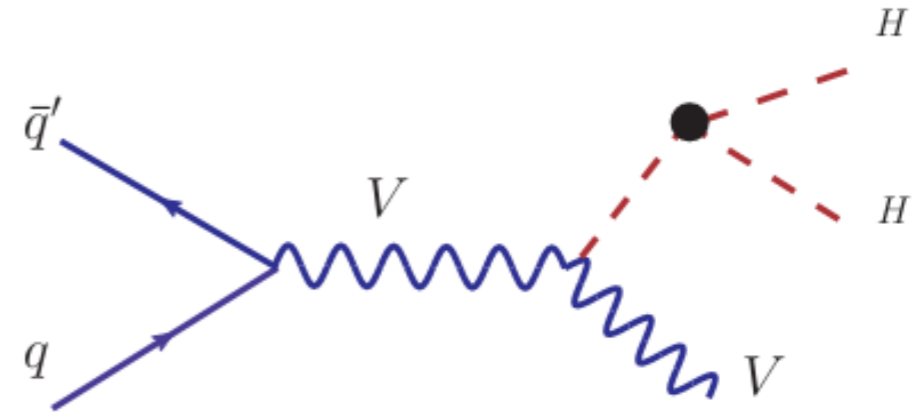

Cross section: 2.01 fb

>>

Cross section: 0.57 fb

Final states: $bb\tau\tau$

$$Br(bb\tau\tau) = 0.036$$

Final states: $bbbb$

$$Br(bbbb\nu) = 0.073$$

$$\sigma \times Br(bb\tau\tau) = 0.073 \text{ fb}$$

$$\sigma \times Br(bbbb\nu) = 0.042 \text{ fb}$$

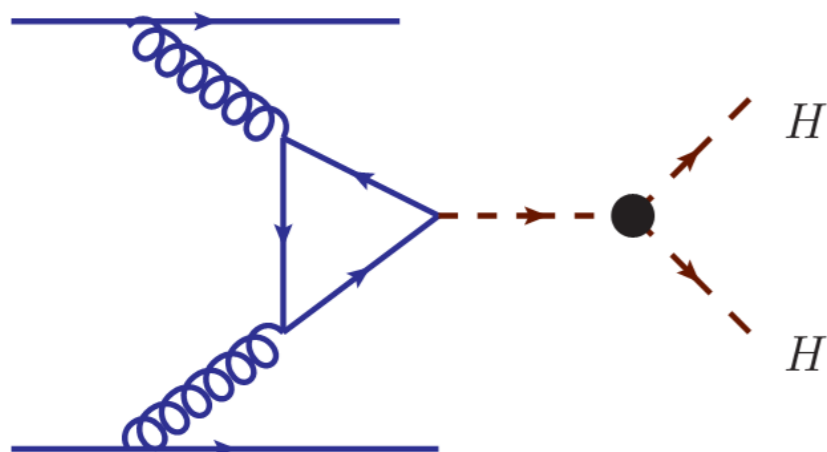

>

Isolated weak boson fusion?

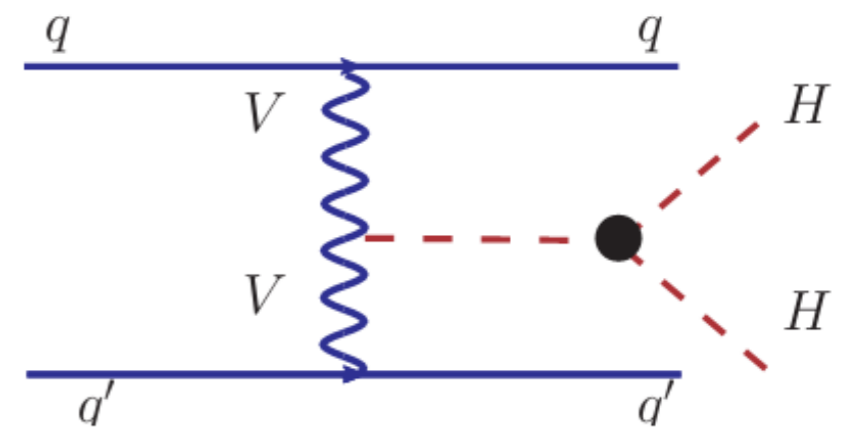

WHH and ZHH Productions

TABLE III: The sensitivity to $\lambda_{HHH} = \kappa\lambda_{HHH}^{\text{SM}}$ in several production channels of Higgs boson pairs at the HL-LHC.

	SM ($\kappa = 1$)	5σ discovery potential	2σ exclusion bound
WHH	1.29σ	$\kappa \leq -7.7, \kappa \geq 4.8$	$-5.1 \leq \kappa \leq 2.2$
ZHH	1.32σ	$\kappa \leq -8.1, \kappa \geq 4.8$	$-5.4 \leq \kappa \leq 2.2$
GF($b\bar{b}\gamma\gamma$) [42]	1.19σ	$\kappa \leq -4.5, \kappa \geq 8.1$	$-0.2 \leq \kappa \leq 4.9$
GF($b\bar{b}\gamma\gamma$) [43]	1.65σ	$\kappa \leq -2.6, \kappa \geq 6.3$	$0.5 \leq \kappa \leq 4.1$
VBF [20]	0.59σ	$\kappa \leq -1.7, \kappa \geq 5.0$	$-0.4 \leq \kappa \leq 3.5$
$t\bar{t}HH$ [21, 22]	1.38σ	$\kappa \leq -11.4, \kappa \geq 6.9$	$-7.2 \leq \kappa \leq 2.5$

The discovery potential of triple Higgs coupling in VHH production is **comparable** to other channels.

Nordstrom and Papaefstathiou (arXiv:1807.01571)

include full detector effects and show that measuring HHH coupling via WHH and VHH channels is very challenging.

QHC, Liu, Yan,
Phys.Rev. D95 (2017) no.7, 073006

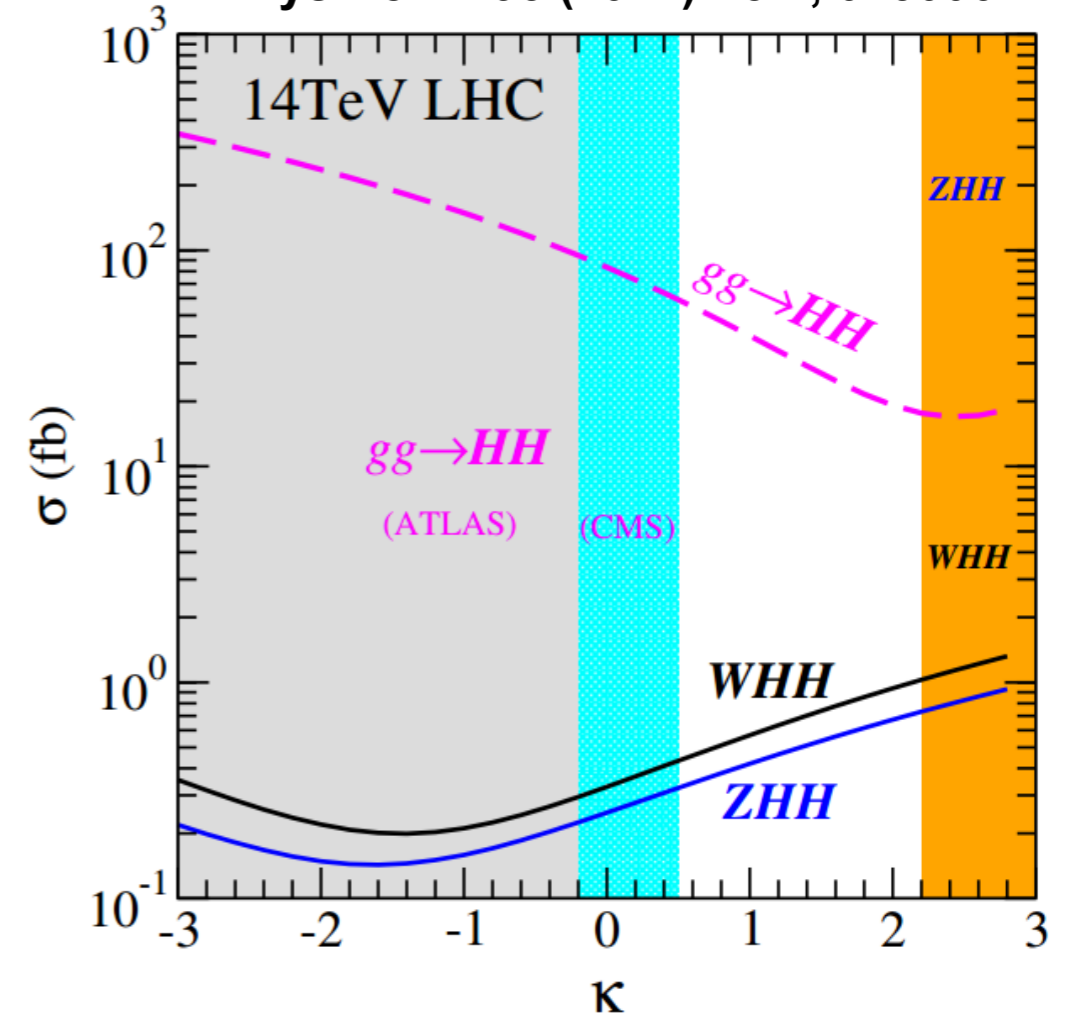

$$0.5 \leq \kappa \leq 2.2$$

Higgs as a pseudo Nambu-Goldstone



The Signature of Pseudo Nambu-Goldstone Higgs Boson in its Decay

Ling-Xiao Xu (徐凌霄)
School of Physics, Peking University

Collaborate with Qing-Hong Cao, Bin Yan, Shou-hua Zhu, to appear

Aug ??, 2018 @ Tianjin

3) Higgs-Fermion Interaction

First observation of Higgs-Top coupling

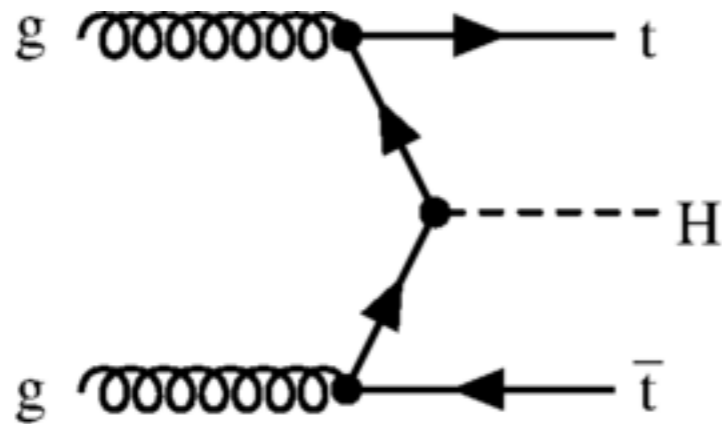

$$\mu_{t\bar{t}H} = 1.26^{+0.31}_{-0.26}$$

CMS: PRL120,231801 (2018)

Observation of ttH Production with the ATLAS Detector

Lianliang MA (马连良)
Shandong University

June 20-24, 2018@Shanghai

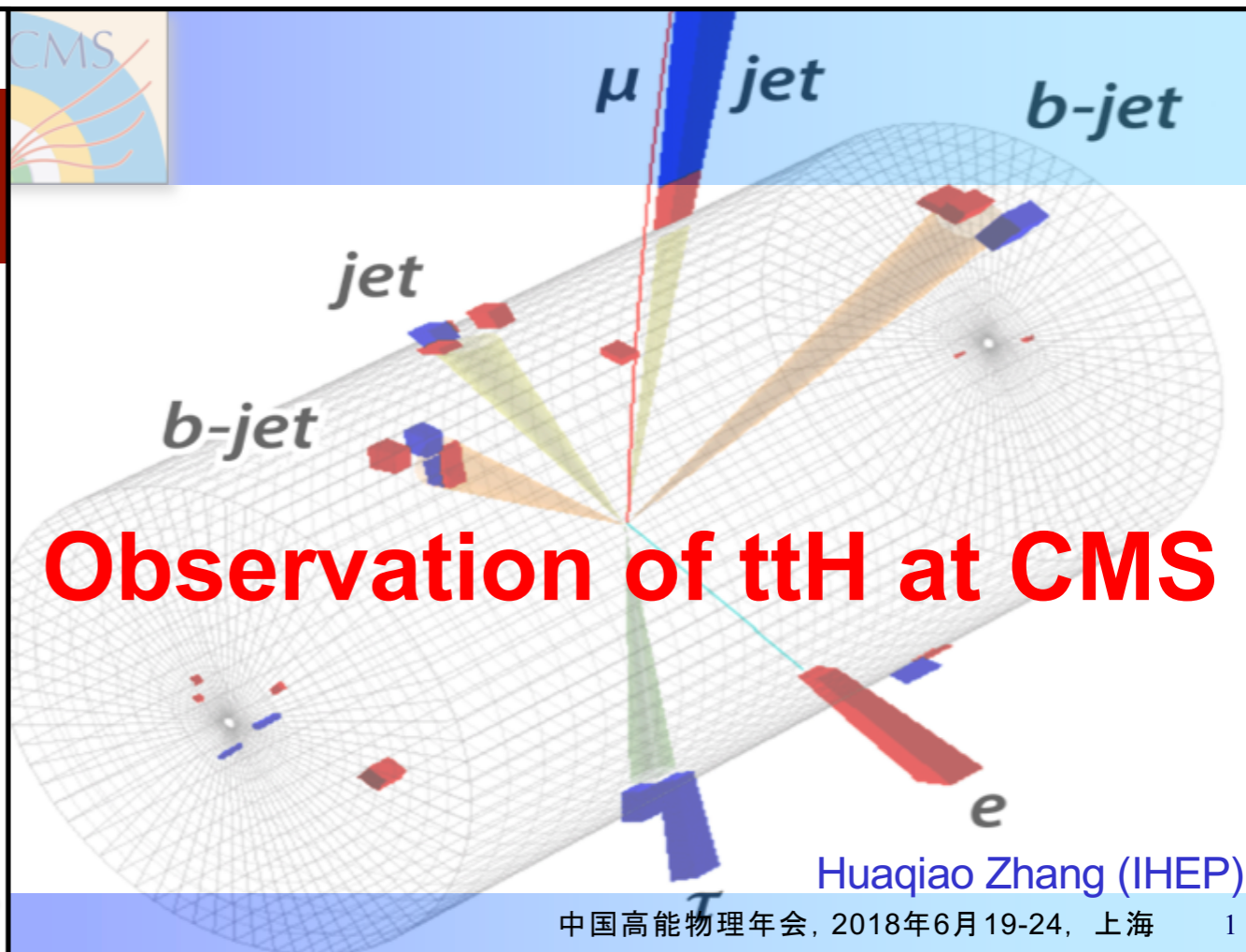

Observation of ttH at CMS

Huaqiao Zhang (IHEP)

Good News: Higgs-Bottom Coupling

July 9th, ICHEP18, Seoul

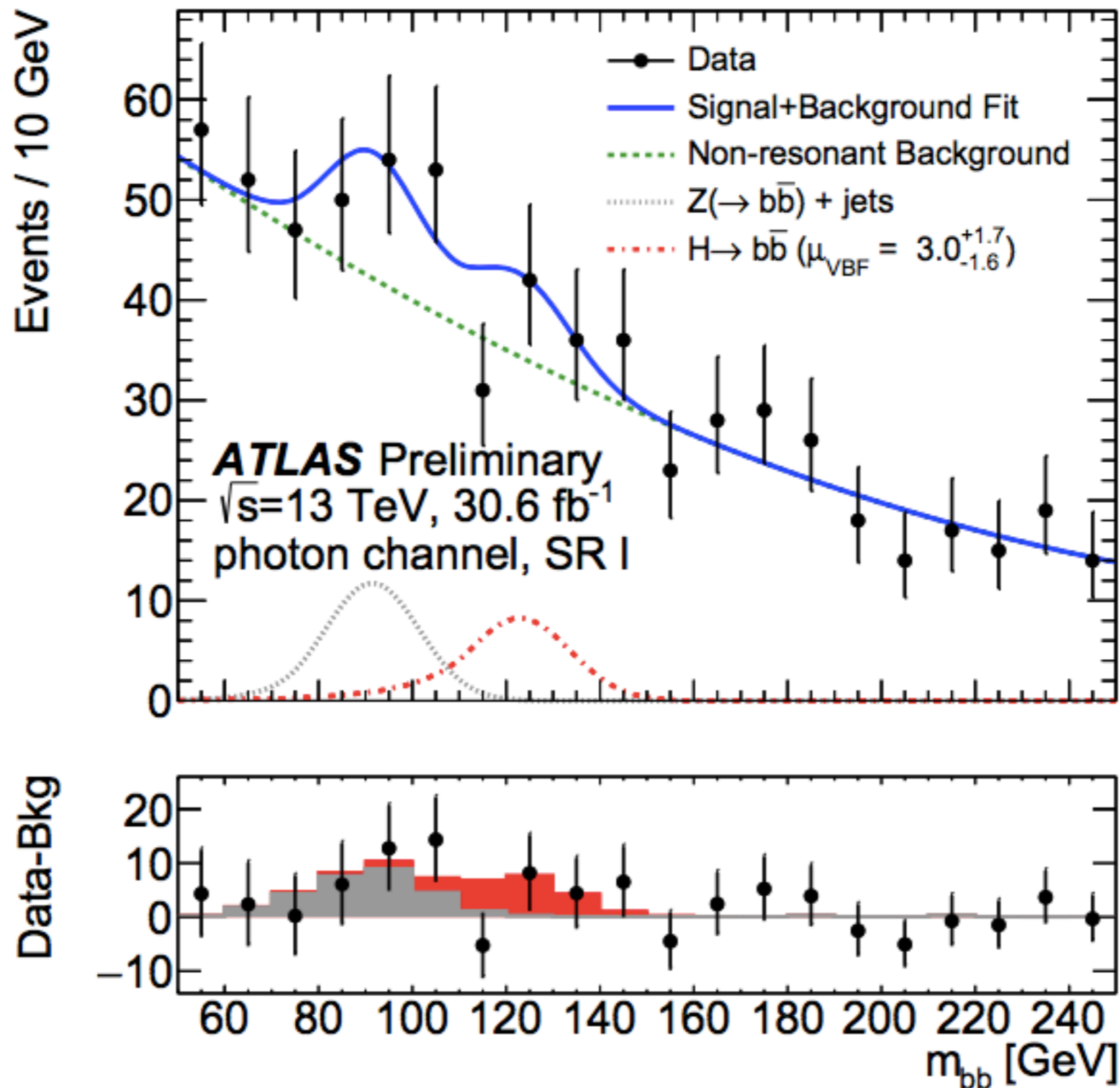

Sizing Up Top Quark's Interaction with Higgs

Four-top production

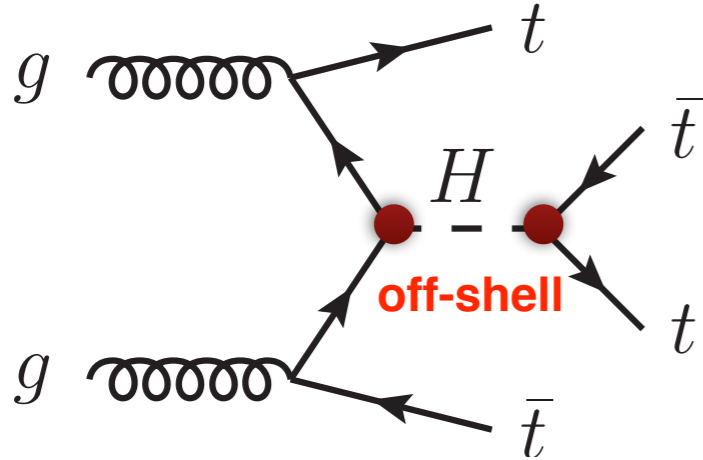

QHC, Chen, Liu
PRD95 (2017) 053004

**No assumption
on Higgs decay**

tth associated production

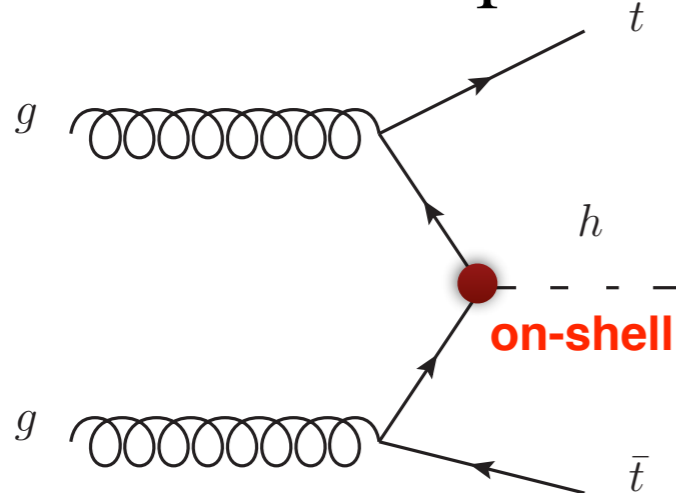

**Depends on
Higgs decay**

CMS [arXiv:1710.10614](https://arxiv.org/abs/1710.10614) 35.9 fb⁻¹ (13 TeV)

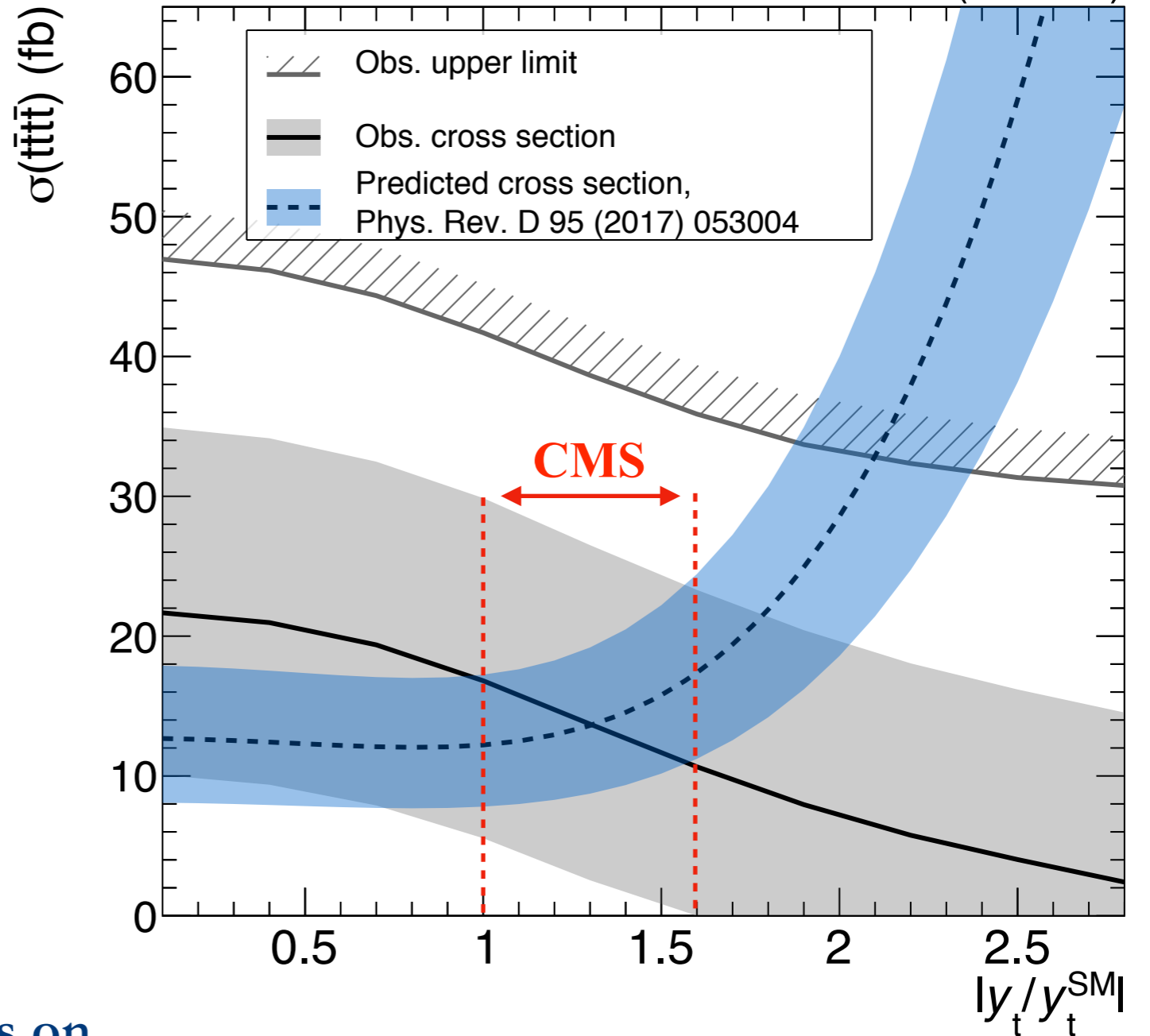

$$y_t / y_t^{\text{SM}} \leq 2.1$$

The CP property of Htt coupling

Goncalves, Kim, Kong
arXiv:1804.05874

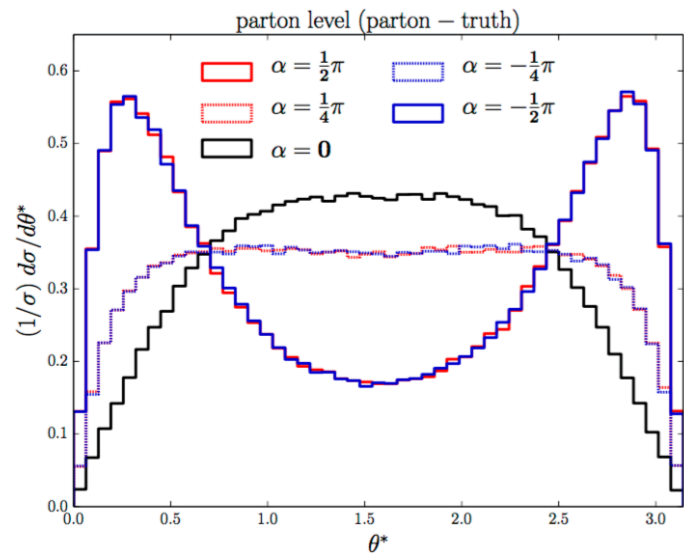

CS-frame

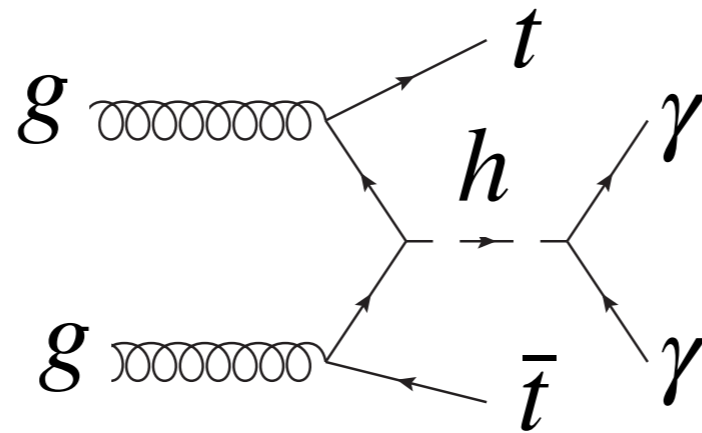

need
top-quark
reconstruction

QHC, Xie, Zhang
in preparation

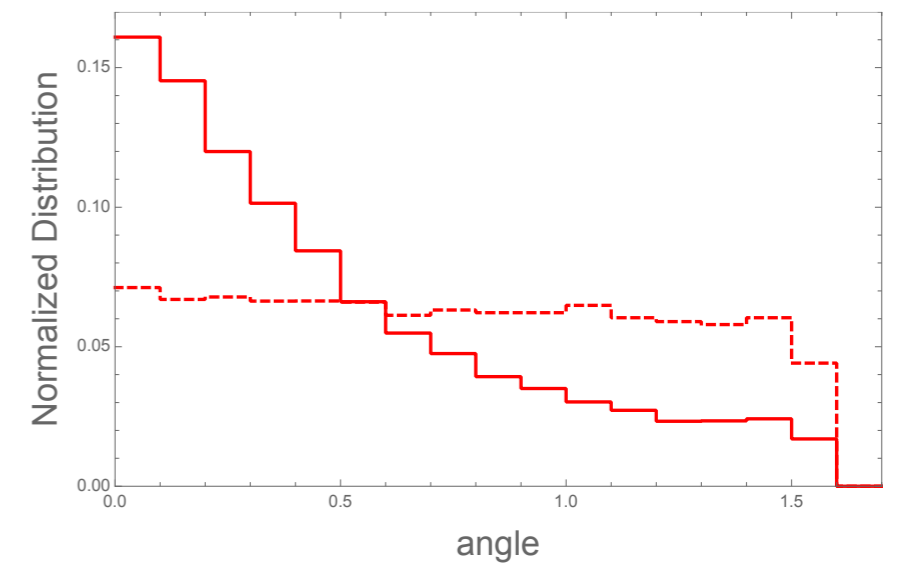

After cuts

Hadron level

After cuts

Hadron level

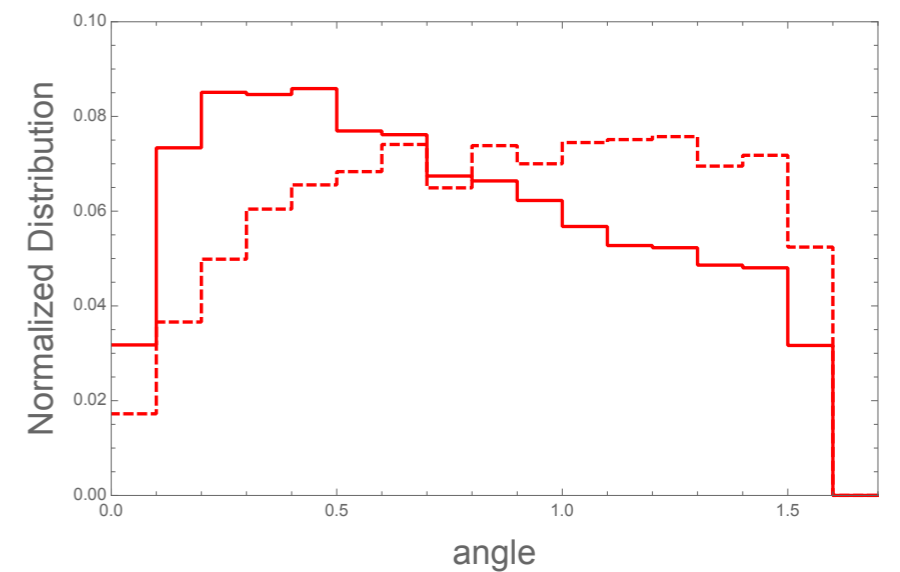
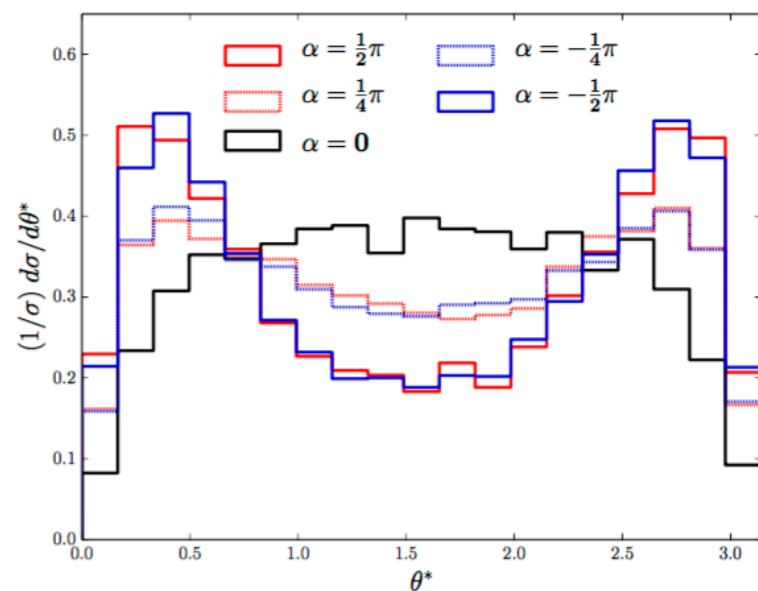

no need to
reconstruct top quark

Interim Summary

$$\mathcal{L} = \left(D_\mu \Phi \right)^\dagger (D^\mu \Phi) - \mu^2 \Phi^\dagger \Phi + \lambda (\Phi^\dagger \Phi)^2 + y_f \bar{F}_L \Phi F_R + \dots$$

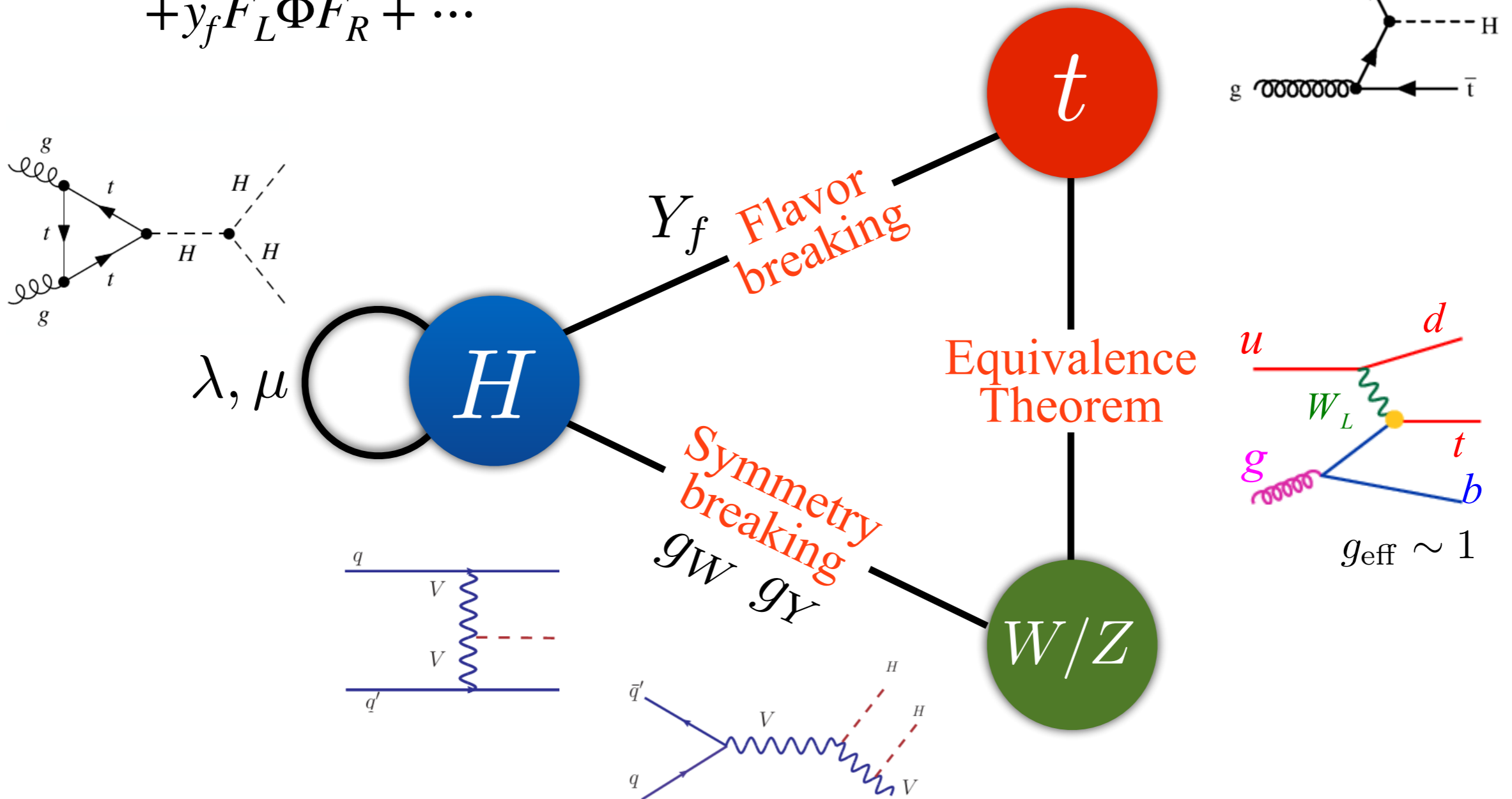

More accurate knowledge of Higgs boson might shed lights on NP.

What if NP knew nothing about Higgs?

Higgs boson discovery — ? — the END of the era of SM

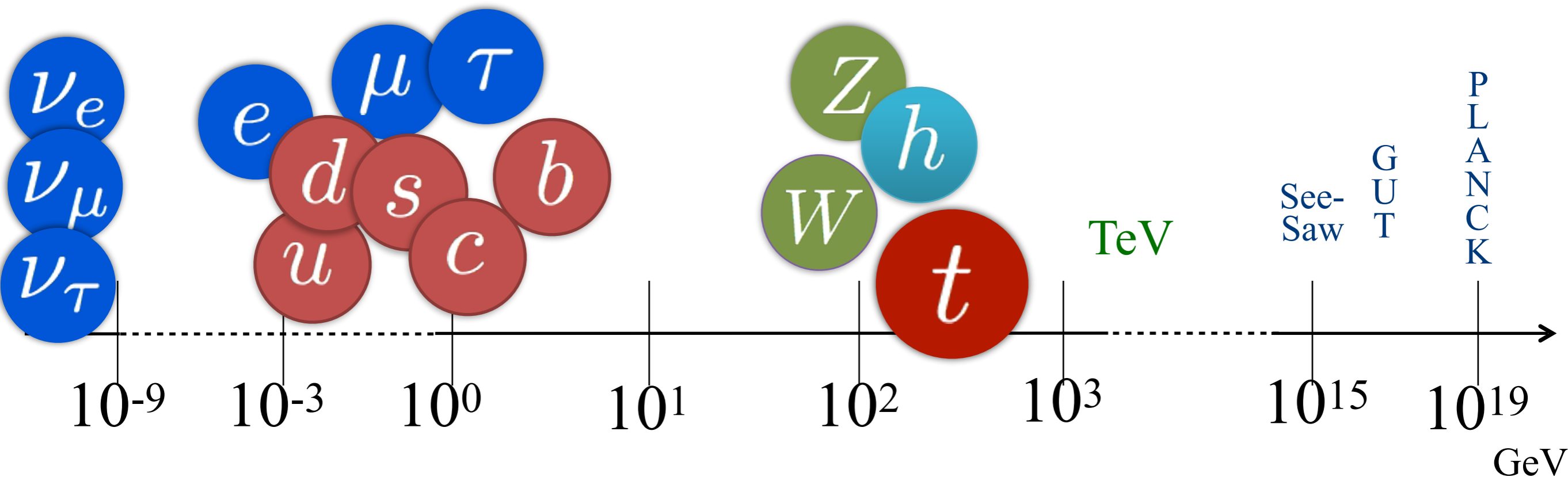

Q1. Why are light quarks so light?

Top quark and W/Z bosons are naturally around the weak scale.

Q2. Heavy NP particles cannot achieve mass mainly from Higgs.

NP scale = New Resonance Mass $\sim 2\text{TeV}$

$$g \times v \sim 8 \times 246 \text{ GeV} = 2 \text{ TeV}$$

The EFT of QED (infinite m_e)

Heisenberg-Euler operator in QED

(Imagine we are living in a world full of photon but not electron)

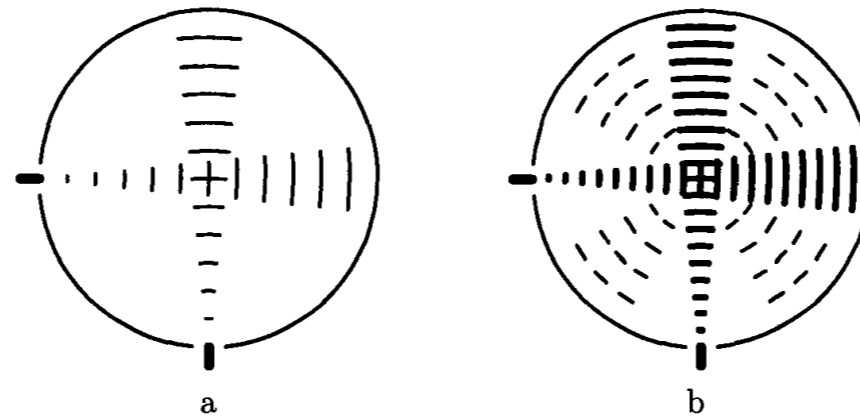

After matching in QED

$$L = -\frac{1}{4}F_{\mu\nu}F^{\mu\nu} + \frac{\alpha^2}{180m^4} \left[-5(F_{\mu\nu}F^{\mu\nu})^2 + 14F_{\mu\nu}F^{\nu\alpha}F_{\alpha\beta}F^{\beta\mu} \right]$$

NP scale m_e

Application ($\omega \ll m$)



$$\rho \propto T^4, \frac{\alpha^2}{m^4} T^8$$

Radiative correction to the Stefan-Boltzmann law

EFT of QED (photon + electron)

$$L = \bar{\psi}(i \not{D} - m)\psi - \frac{1}{4}F_{\mu\nu}F^{\mu\nu} + \frac{c}{M^2}m\bar{\psi}F_{\mu\nu}\sigma^{\mu\nu}\psi + \dots$$

NP scale m_μ

Two ways to probe NP:

1. To raise collider energies to produce real new particles (muon);
2. To measure low-energy quantities (e.g. electron magnetic moment) with high precision

We were lucky 90 years ago when the cosmic rays brought Muon lepton to us.

What about now?



Who ordered that?

LHC: A Precision Machine

in case of no new resonances were found in 10 years

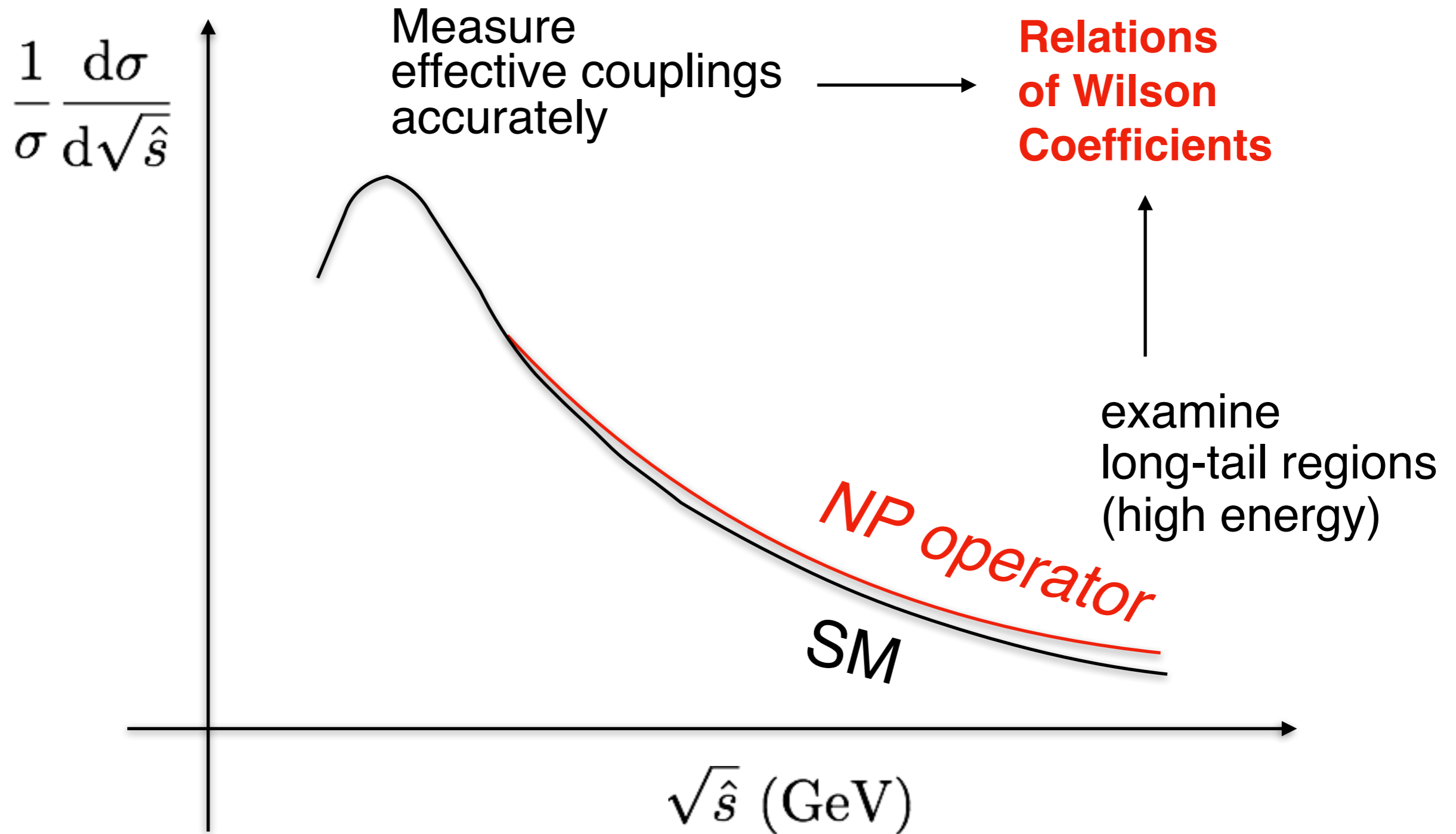

单个图形在高能区都有坏的行为（散射几率随能量增加而破坏几率守恒），但自然界巧妙地运用规范对称性将不同图形之间的坏行为相互抵消掉。

1970 - 2018

from inspires-hep

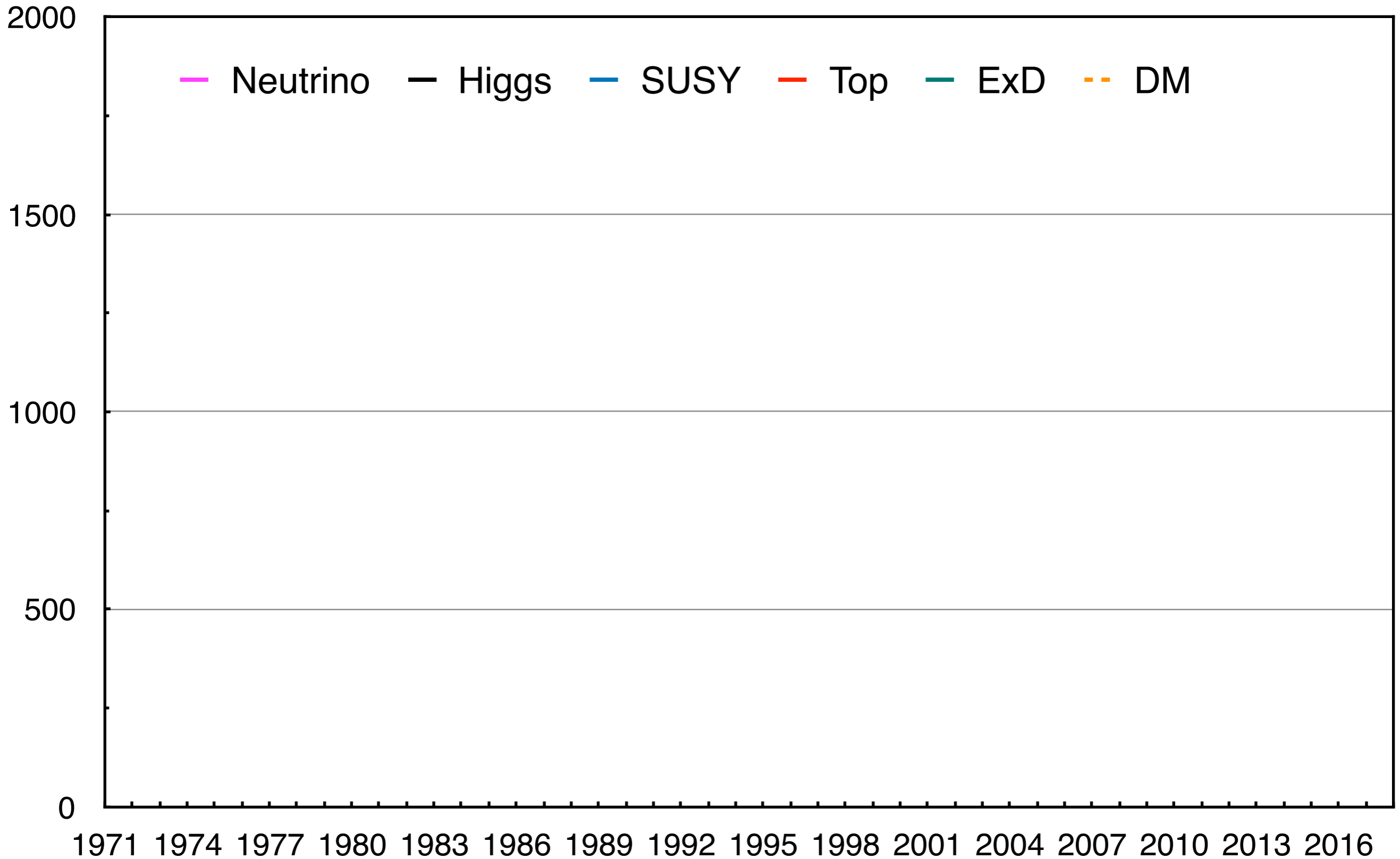

1970 - 2018

from inspires-hep

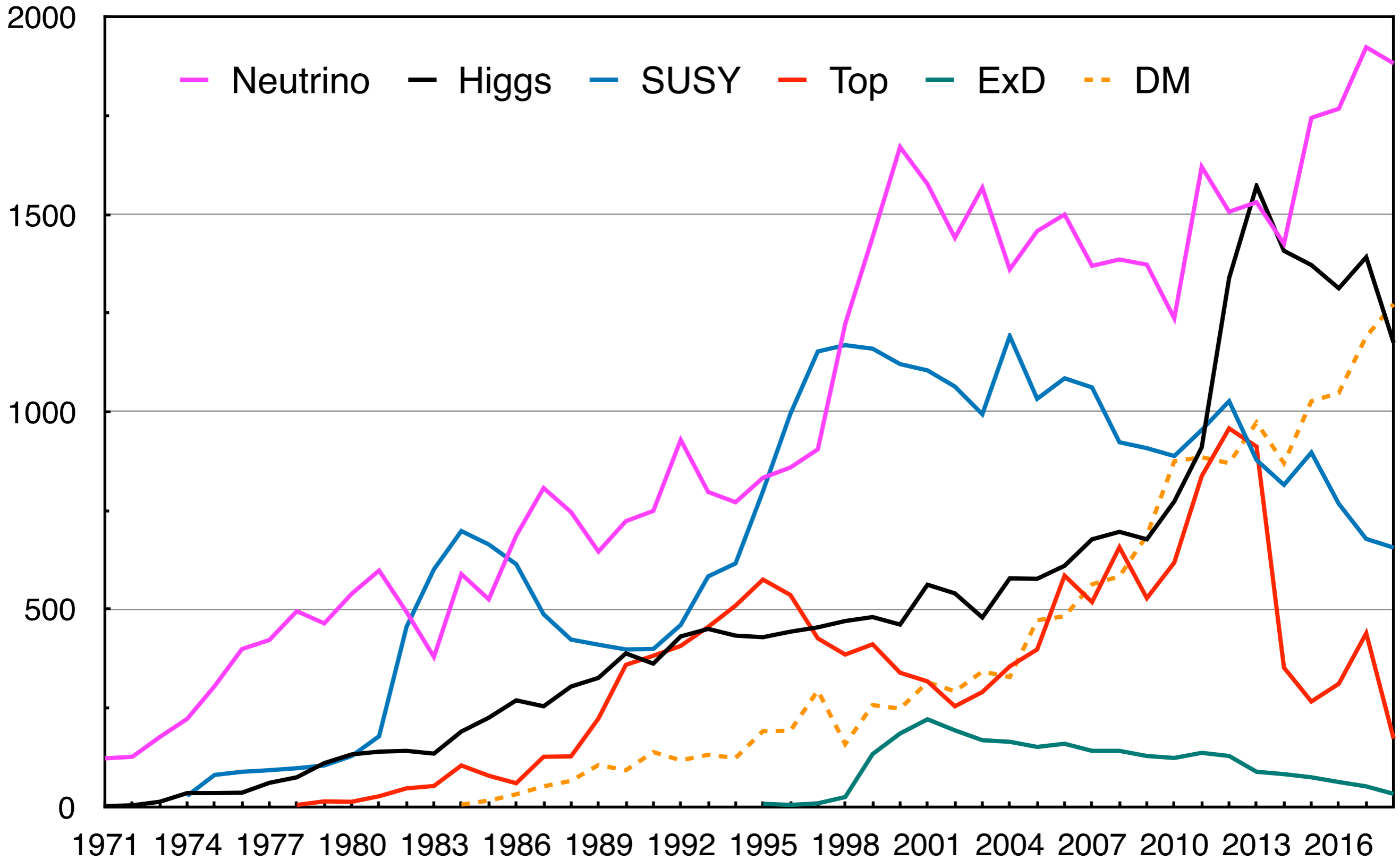

Thank You!