

New Physics Searches LHC and beyond

LianTao Wang
U. Chicago

Summer Institute, 2018 Pan Shan, Tianjin

The Standard Model

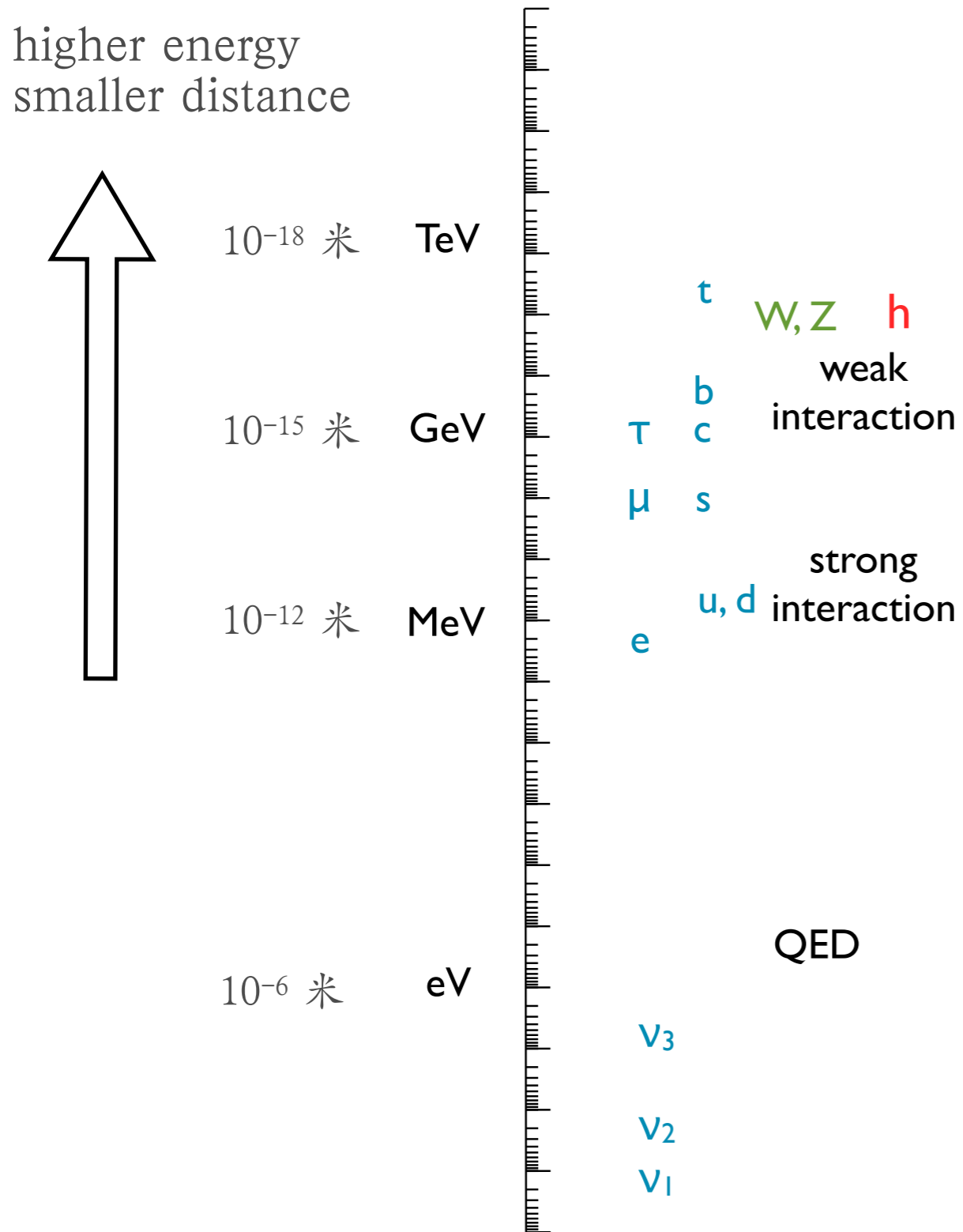

The discovery of the Higgs boson

higher energy
smaller distance

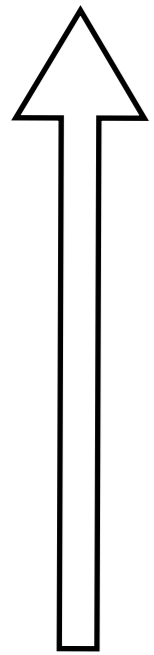

10^{-18} 米 TeV

10^{-15} 米 GeV

10^{-12} 米 MeV

10^{-6} 米 eV



t
 W, Z h
 weak interaction
 τ b c
 μ s
 strong interaction
 e u, d
 QED
 ν_3
 ν_2
 ν_1

2012 年
LHC, CERN



The discovery of the Higgs boson

higher energy
smaller distance

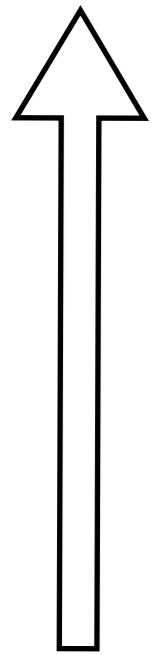

10^{-18} 米 TeV

10^{-15} 米 GeV

10^{-12} 米 MeV

10^{-6} 米 eV



t
w, z h
weak interaction
b c
s
strong interaction
u, d
e

QED

ν_3

ν_2

ν_1

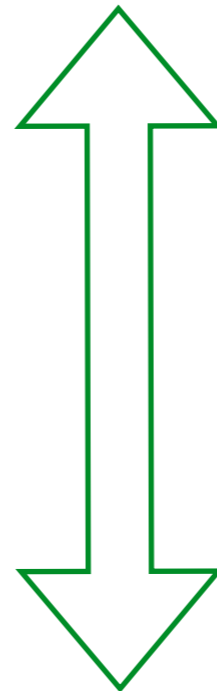

A milestone after
a century of amazing
progress

Beginning of an new era

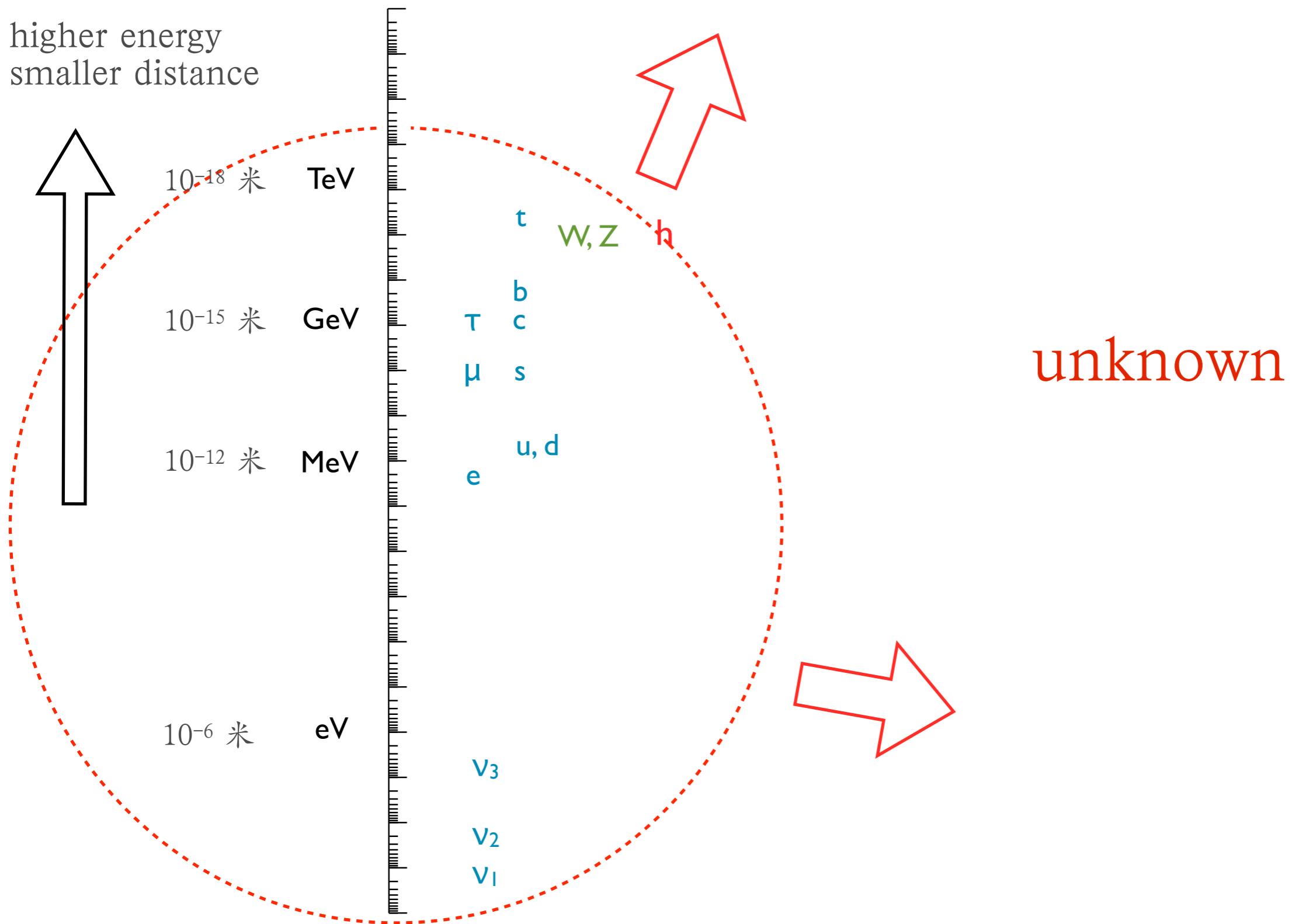

SM: complete yet incomplete

- Complete: could be a consistent theory valid up to the Planck scale.
- Incomplete: many open questions
 - ▶ Origin of electroweak scale
 - ▶ Dark matter
 - ▶ Origin of CP, flavor
 - ▶ ...
- Goal of particle physics: answer these questions.
- Colliders (LHC and beyond) will be crucial.

From gravity to the Higgs we're still waiting for new physics

Annual physics jamboree Rencontres de Moriond has a history of revealing exciting results from colliders, and this year new theories and evidence abound

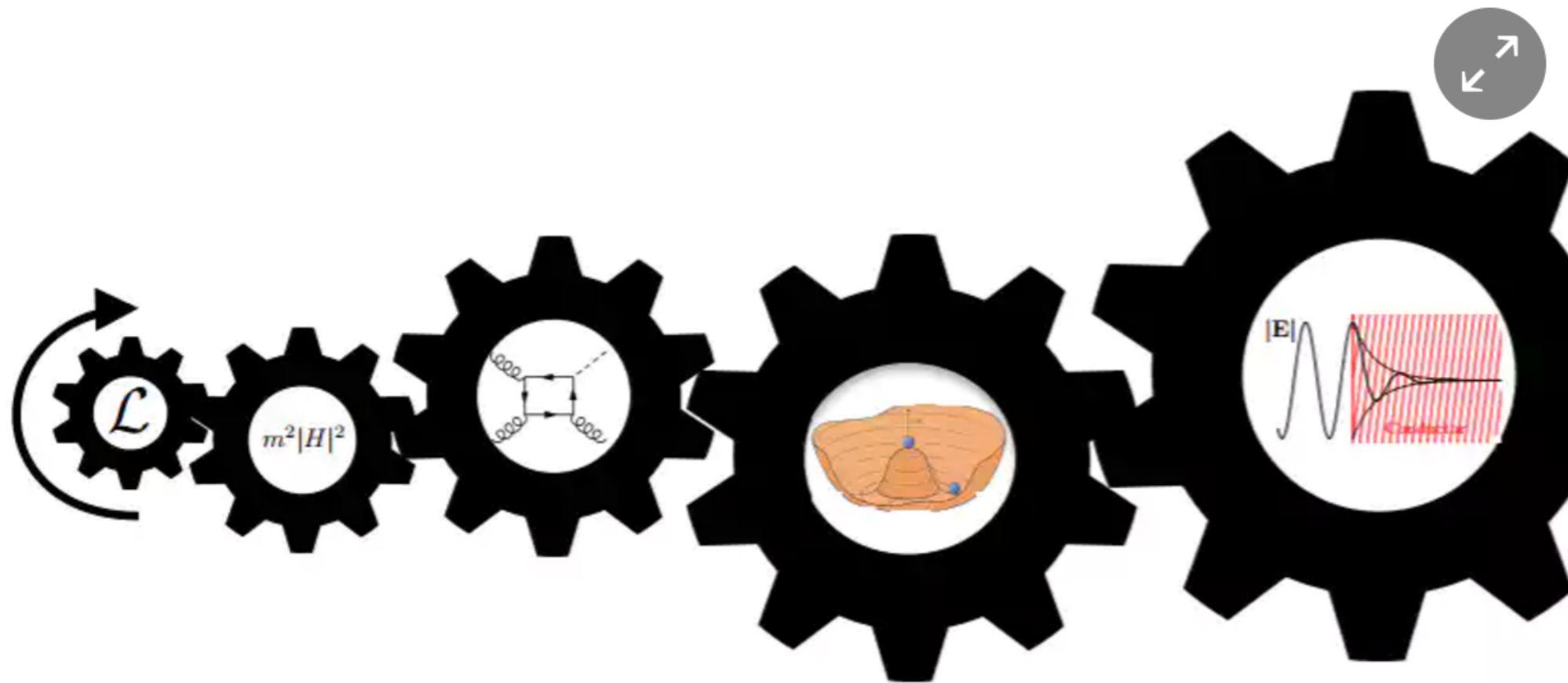

Road ahead at the LHC

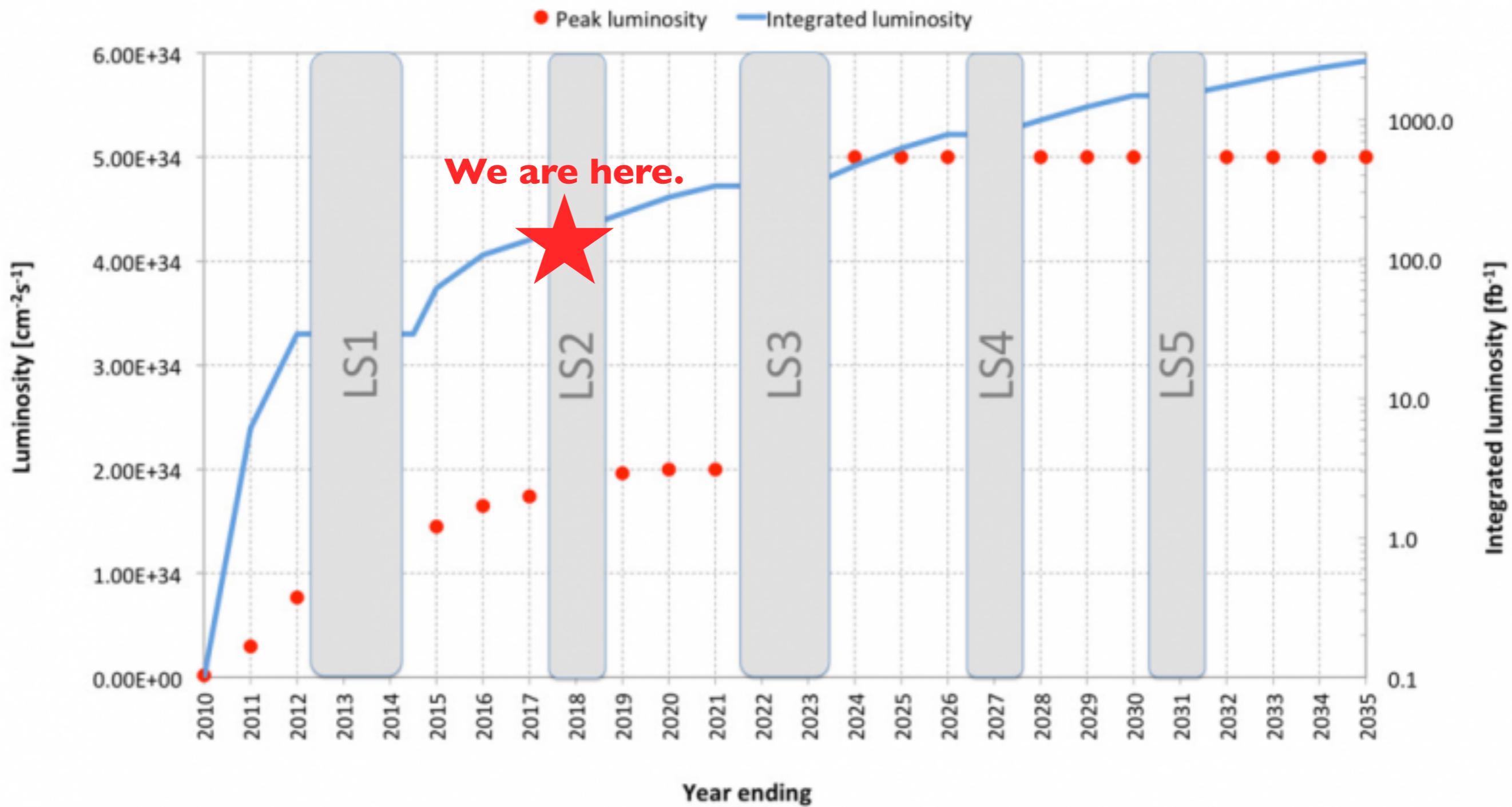

LHC is pushing ahead.

Exp. collaborations are pursuing a broad and comprehensive physics program:
SUSY, composite H, extra Dim, etc.

As data accumulates

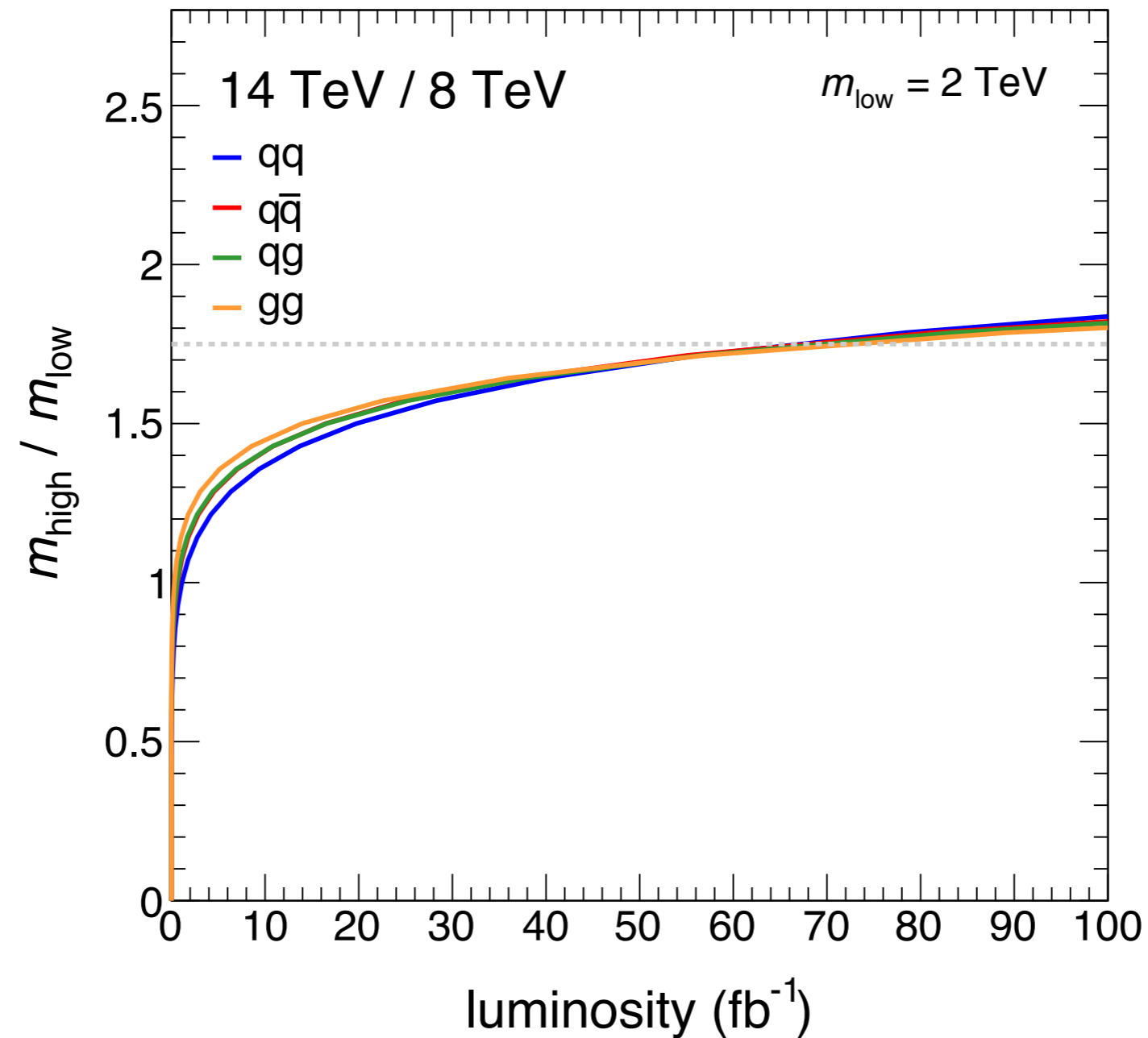

Rapid gain initial 10s-100 fb^{-1} , slow improvements afterwards.

Progress will become slower, harder

New directions?

stronger
coupling



covered by
current searches

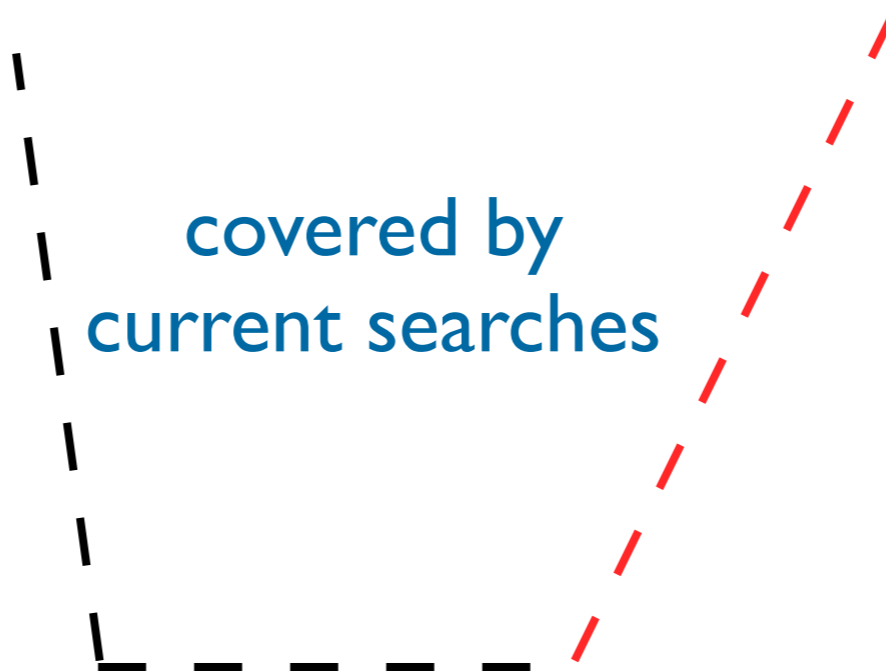

heavier NP
particle

stronger
coupling



covered by
current searches

NP too heavy for LHC
with direct production

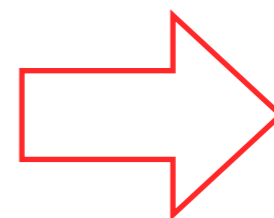

dark sector

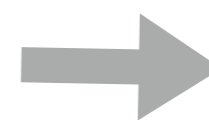
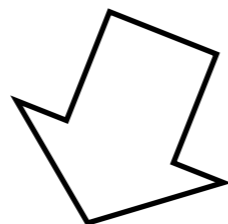

heavier NP
particle

stronger
coupling



covered by
current searches

NP too heavy for LHC
with direct production

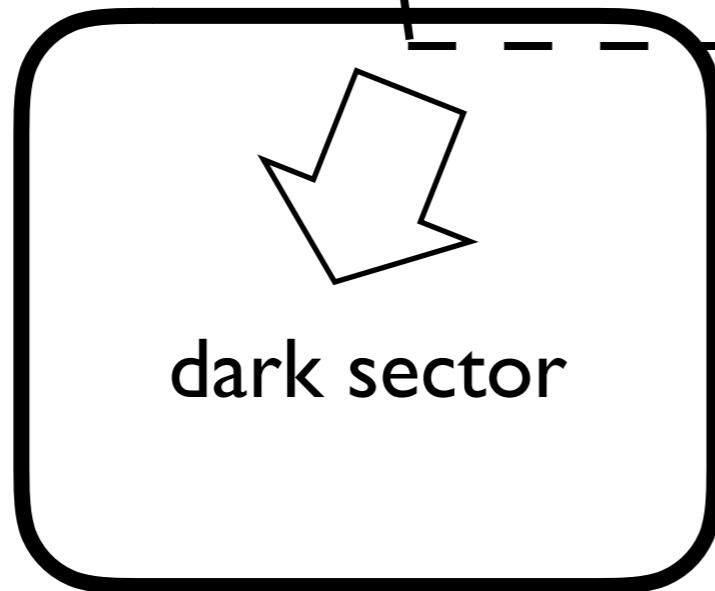
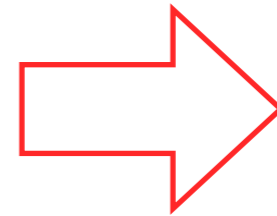

dark sector

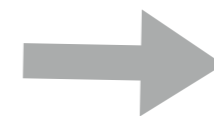

heavier NP
particle

Example: Long Lived particles (LLP)

- Very weakly coupled to the SM.
 - ▶ Connection with dark matter, neutrino, etc.
- Displaced-Long lived, soft, kink, ... Covered by LHC searches already.

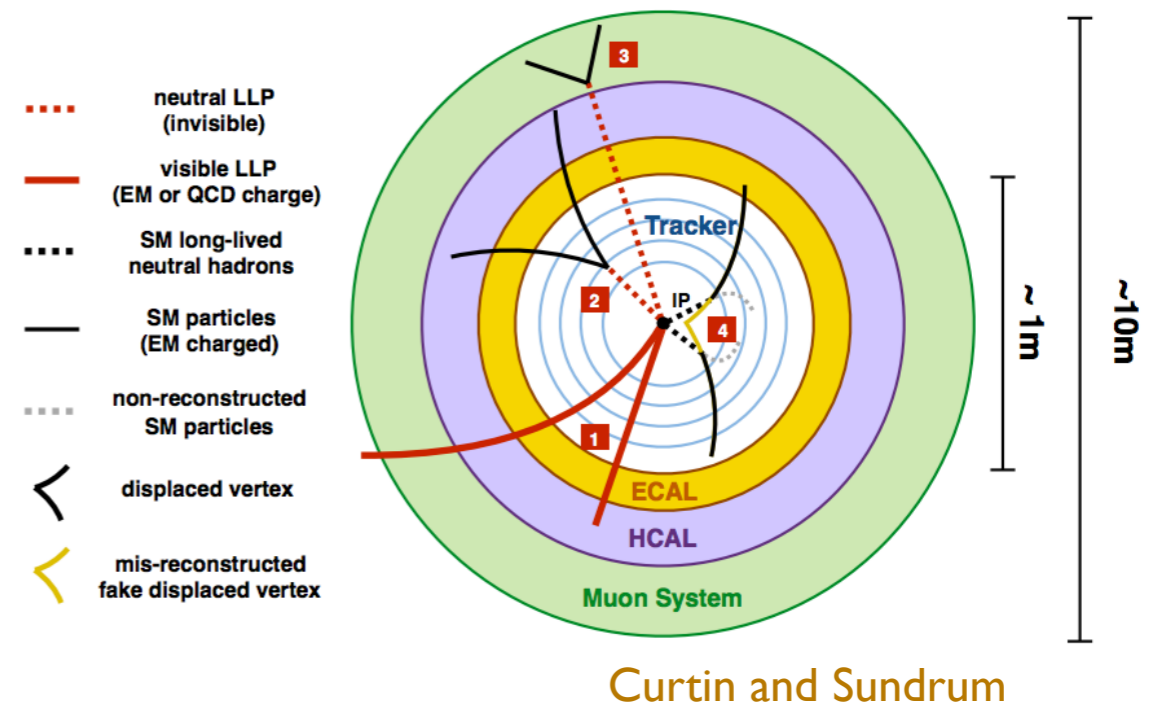

Here, I focus on: decay length \gg 10 meters

tons of models

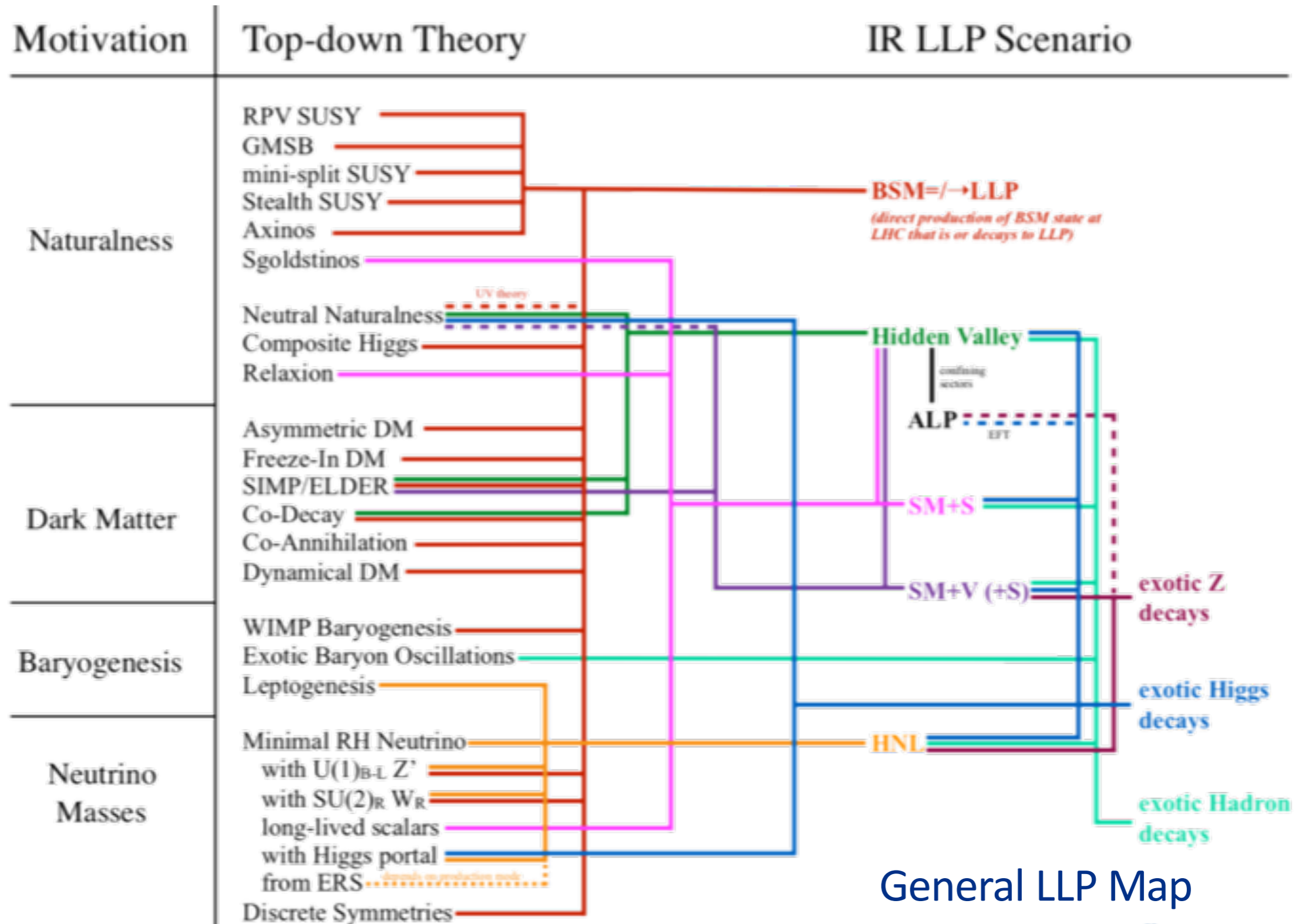

General LLP Map

Far detectors

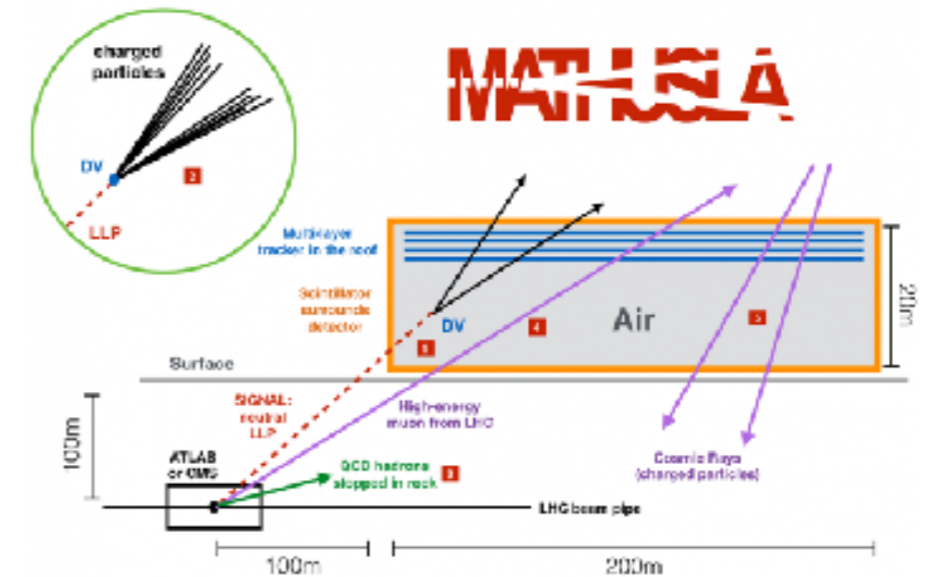
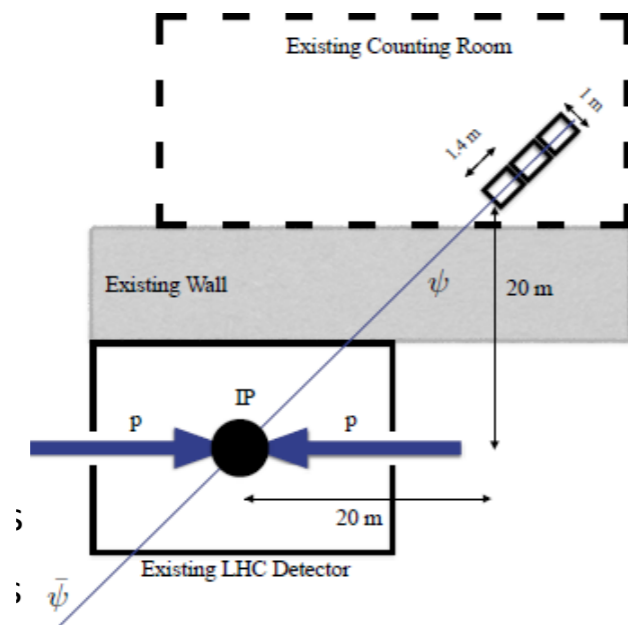

MATHUSLA

new detectors far away from the interaction region

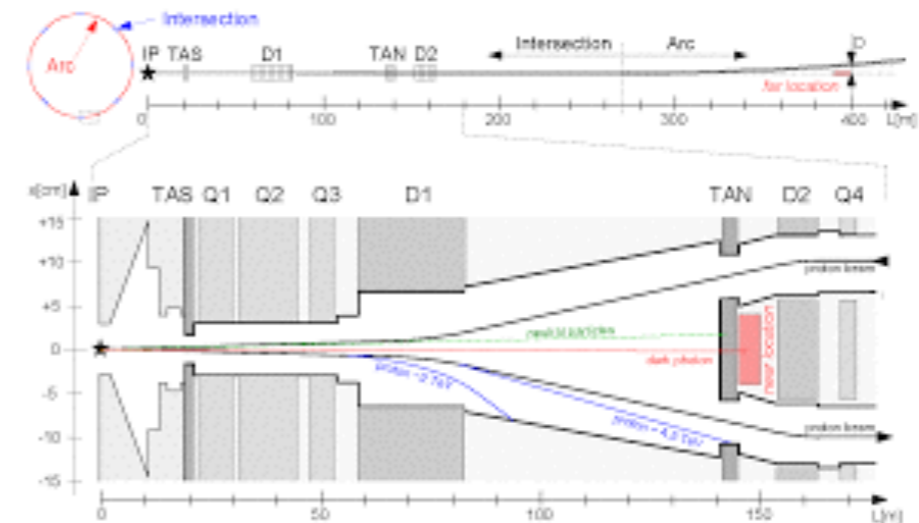
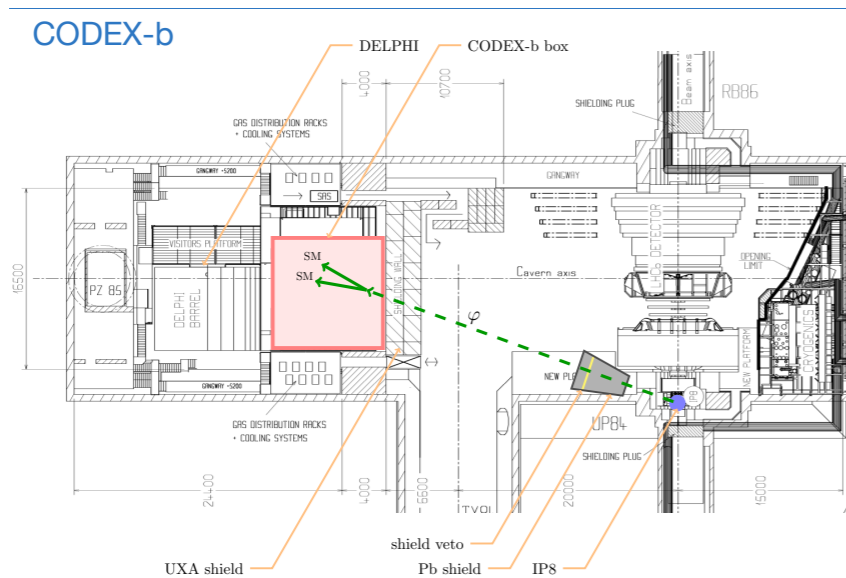

FASER

Could reach $\tau \approx 10^4 - 5 \text{ m}$

Exotic Higgs decays

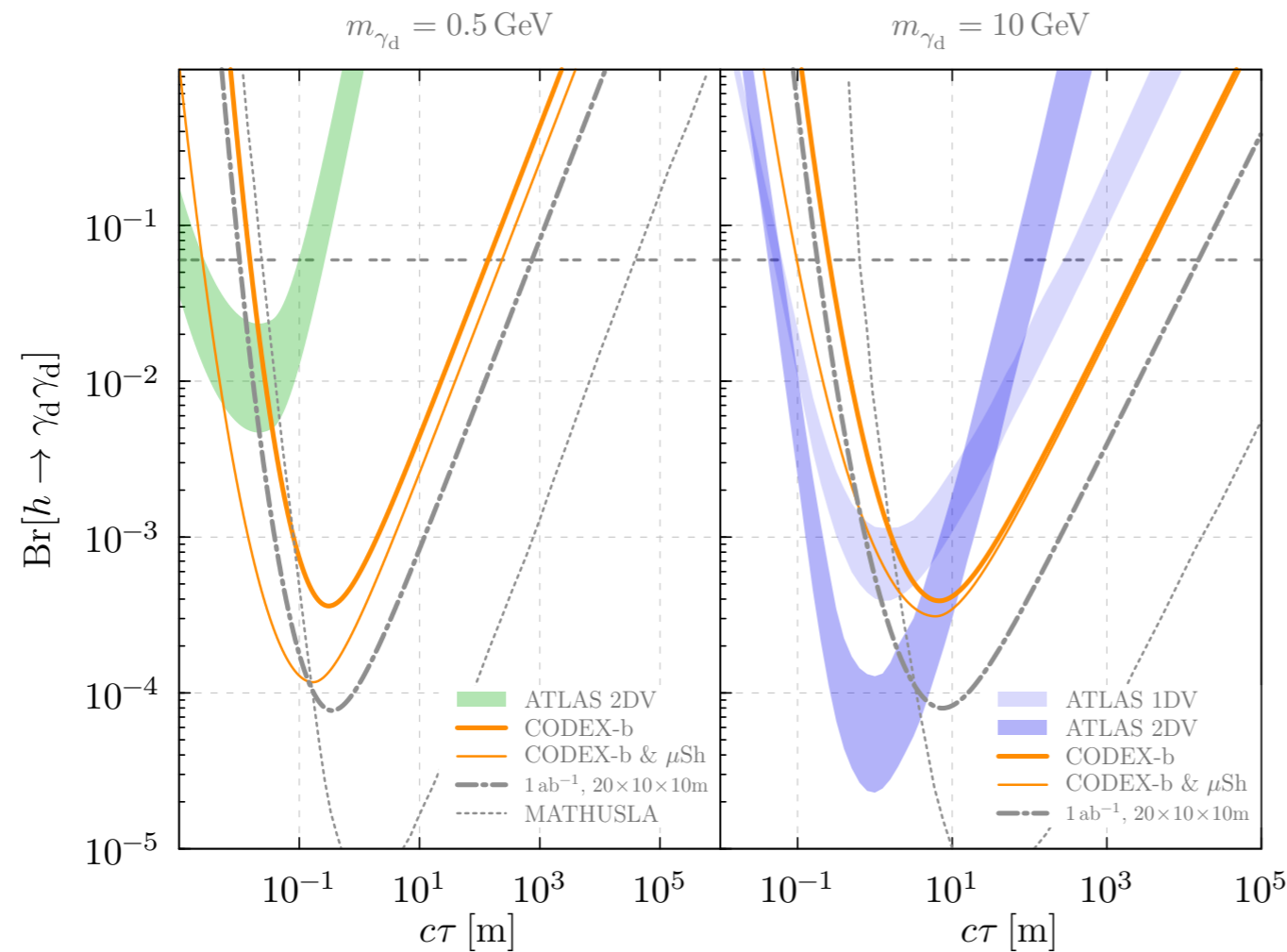
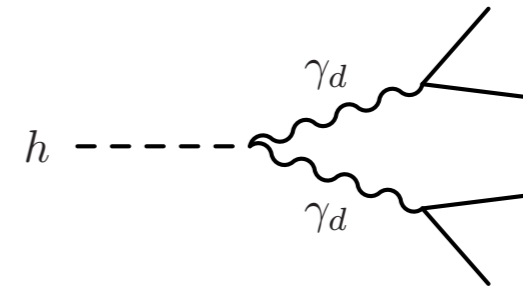

Application:
Neutral Naturalness
(See back-up material)

For low masses, ATLAS/CMS are background limited, CODEX-b & MATHUSLA have an edge

Far detectors

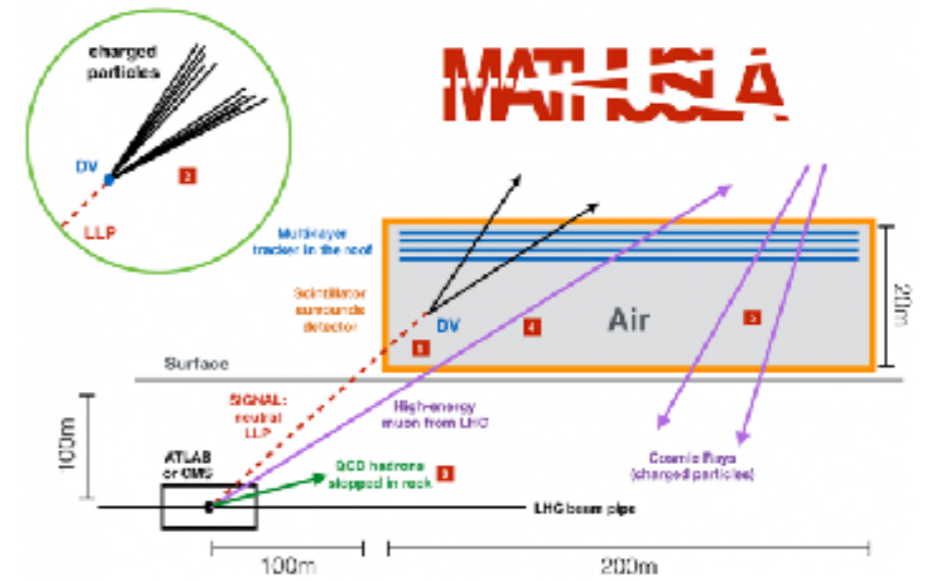
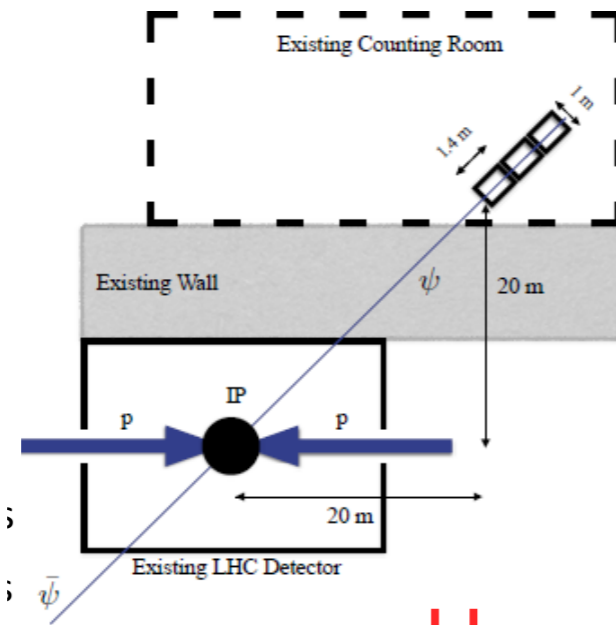

MATHUSLA

Have we fully optimized LLP searches at the interaction points ATLAS, CMS, LHCb?

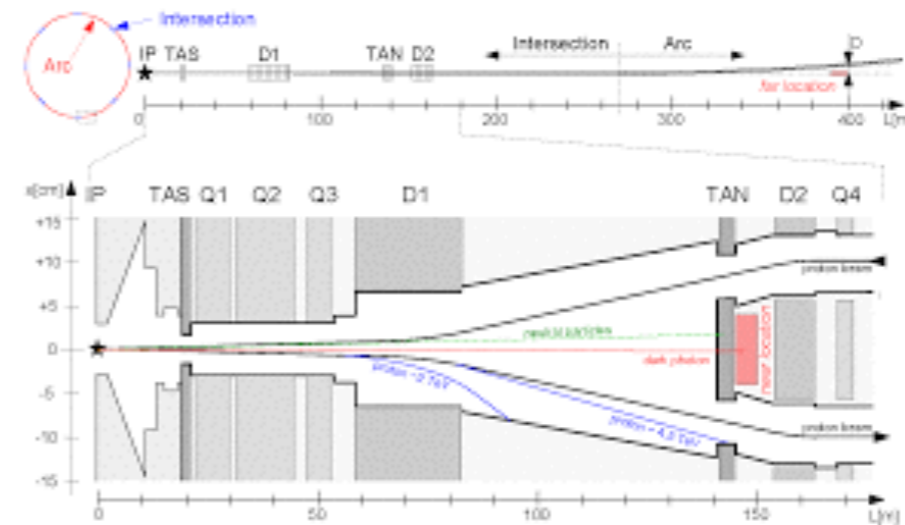
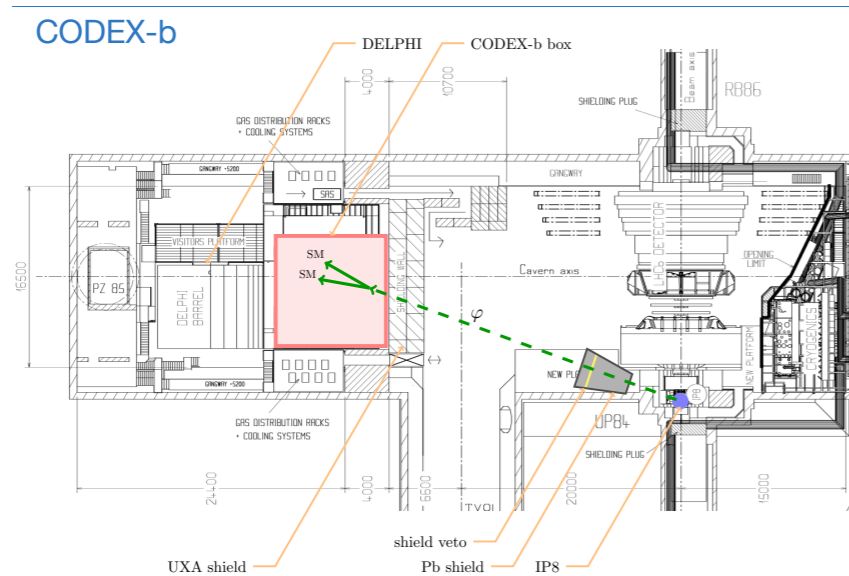

FASER

Optimal place to catch LLP

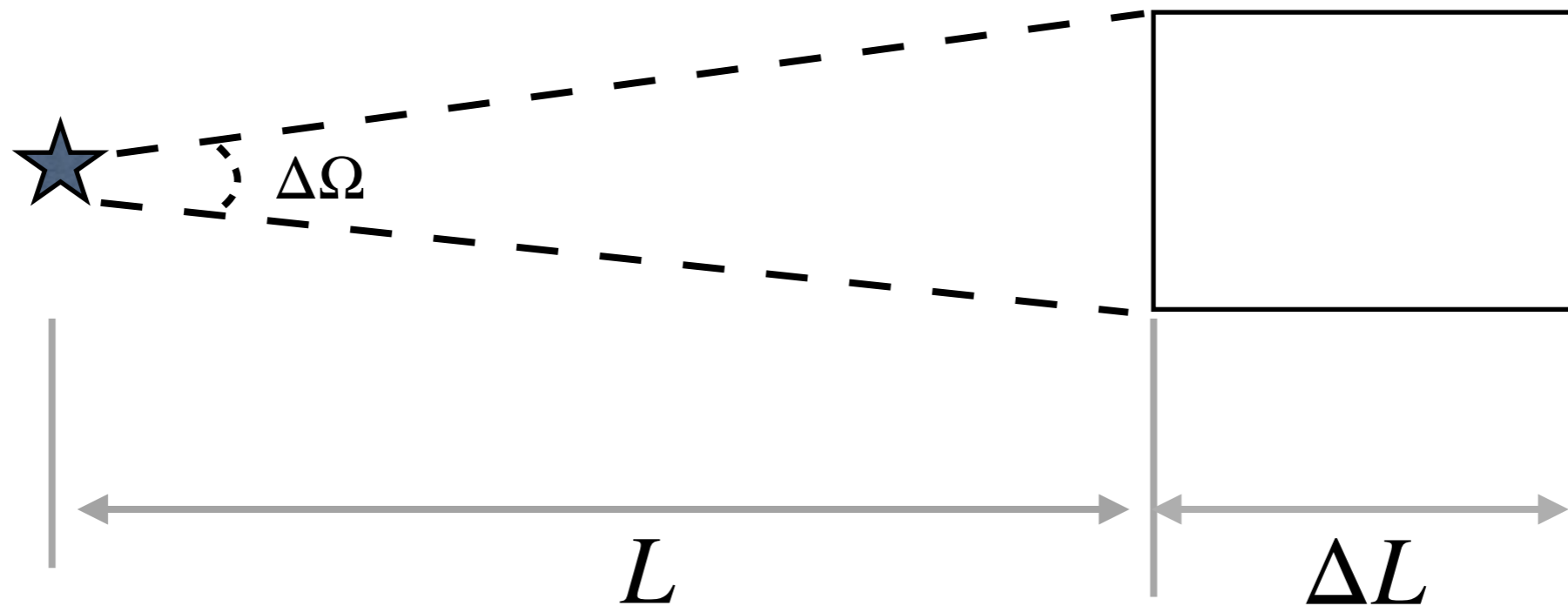

Number of particle decayed within detector volume:

$$\#_{\text{in}} \simeq \#_{\text{produced}} \times \frac{\Delta\Omega}{4\pi} \times \frac{\Delta L}{d} e^{-L/d}$$

$$d = \gamma c \tau \text{ decay length} \quad d \gg \Delta L, L$$

Very long lived: $d \geq 100\text{s meters}$

Optimal place to catch LLP

Number of particle decayed within detector volume:

$$\#_{\text{in}} \simeq \#_{\text{produced}} \times \frac{\Delta\Omega}{4\pi} \times \frac{\Delta L}{d} e^{-L/d} \quad d = \gamma c\tau$$

	ATLAS/CMS (LHCb)	Far detectors
$\Delta\Omega$	$\sim 4\pi$	< 0.1
ΔL	1 – 10 meters	1 – 10 meters
L	1 – 10 meters	10 – 100 meters

Optimal place to catch LLP

$$\#_{\text{in}} \simeq \#_{\text{produced}} \times \frac{\Delta\Omega}{4\pi} \times \frac{\Delta L}{d} e^{-L/d} \quad d = \gamma c \tau$$

	ATLAS/CMS (LHCb)	Far detectors
$\Delta\Omega$	$\sim 4\pi$	< 0.1
ΔL	1 – 10 meters	1 – 10 meters
L	1 – 10 meters	10 – 100 meters

Advantage of far detector?

Far away from interaction point, less background.

We propose to use timing information
Significantly lower background near interaction point.

Time delay

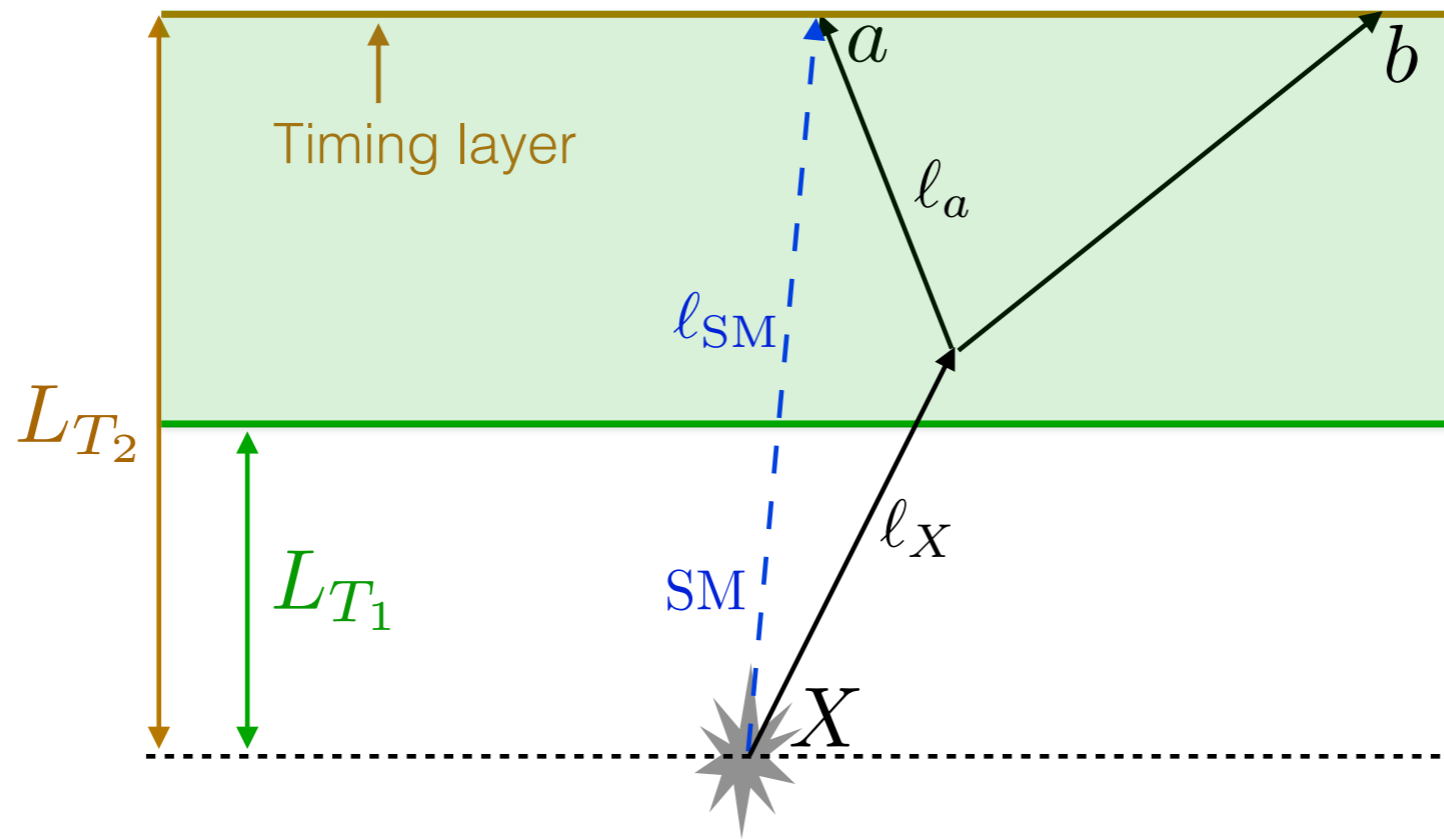

$$\Delta t = \frac{l_X}{\beta_X} + \frac{l_a}{\beta_a} - \frac{l_{SM}}{\beta_{SM}} \quad \beta_a \simeq \beta_{SM} \simeq 1$$

Good for massive LLP produced with small or moderate boost

$$\beta_X < 1$$

Basic topologies

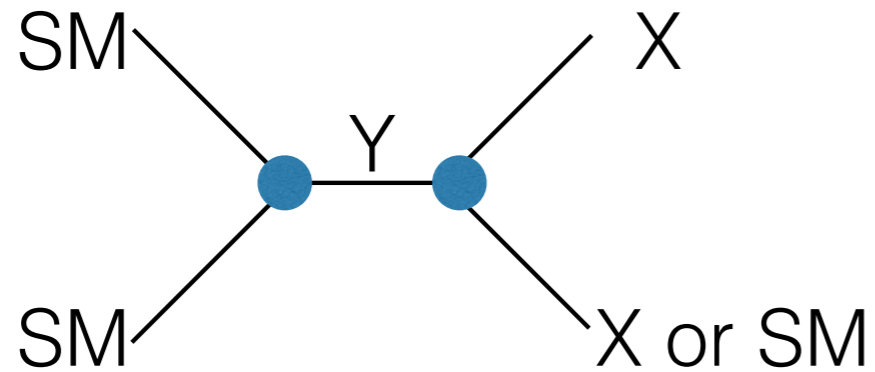

X = LLP

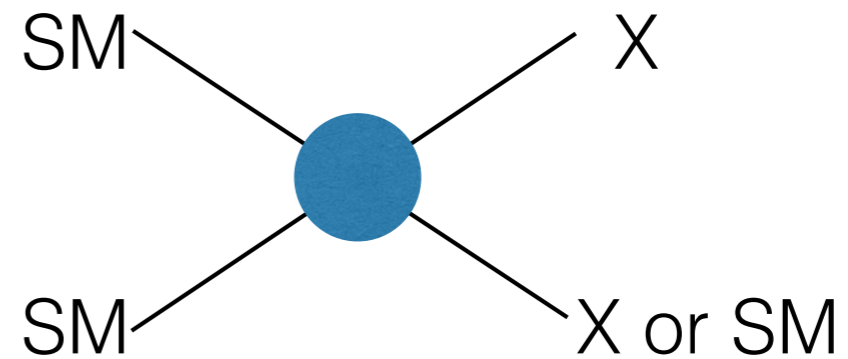

boost:

$$\gamma \simeq \frac{m_Y}{2m_X}$$

challenging for $m_X \ll m_Y$

benchmark: Higgs portal

$Y = \text{Higgs}$

$X \rightarrow \text{SM}$ Long lived

boost:

$$\gamma \sim 1$$

slow moving, sizable Δt

benchmark: SUSY

$X = \text{neutralino}$

$\chi_0 \rightarrow \text{gravitino} + \dots$ Long lived

Sensitivity to Higgs portal

Jia Liu, Zhen Liu, LTW

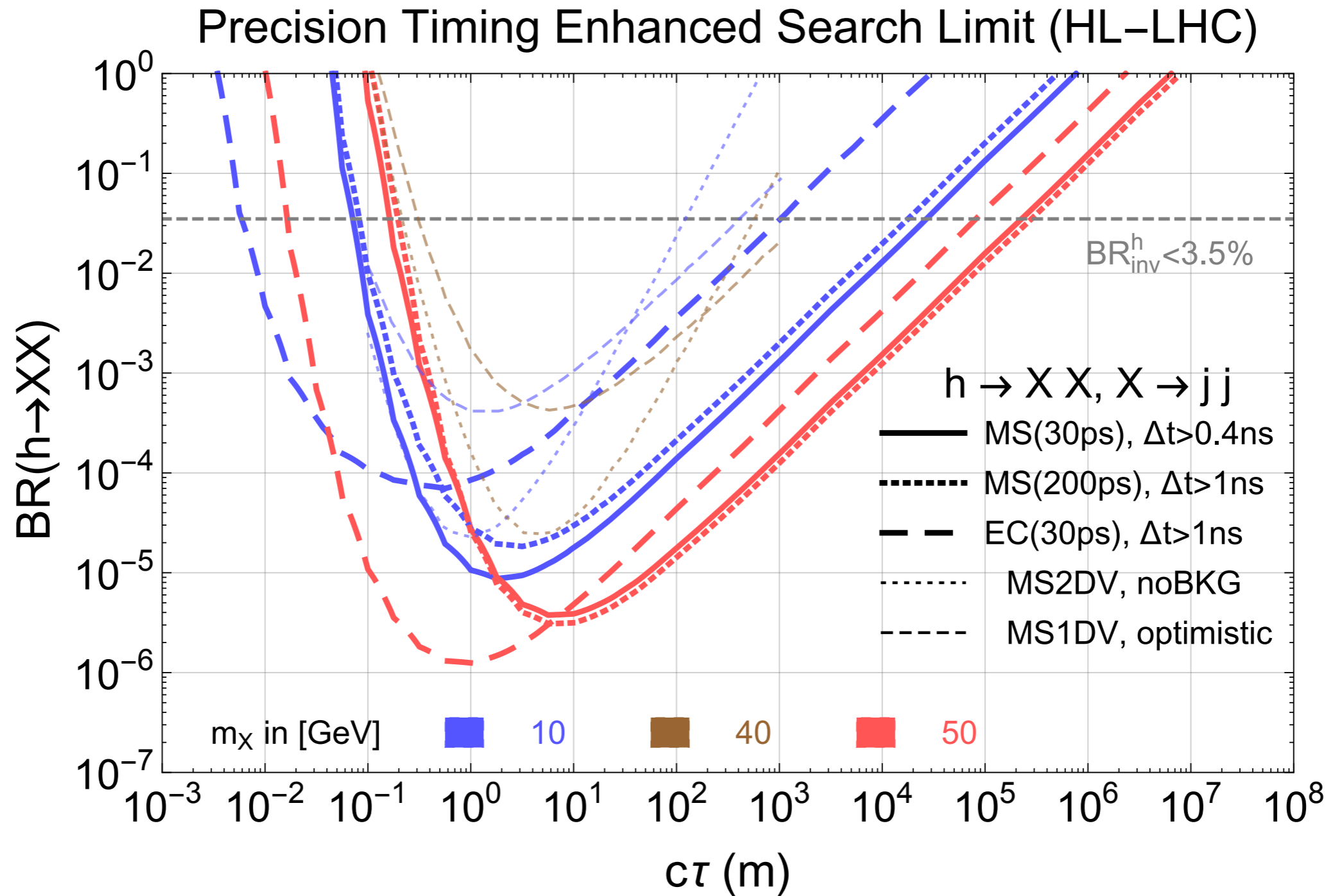

For example, for $BR(h \rightarrow XX) \sim 10^{-3}$
EC(MS) reach can be $c\tau \sim 10^3(10^4)$ meters

Sensitivity to SUSY

Jia Liu, Zhen Liu, LTW

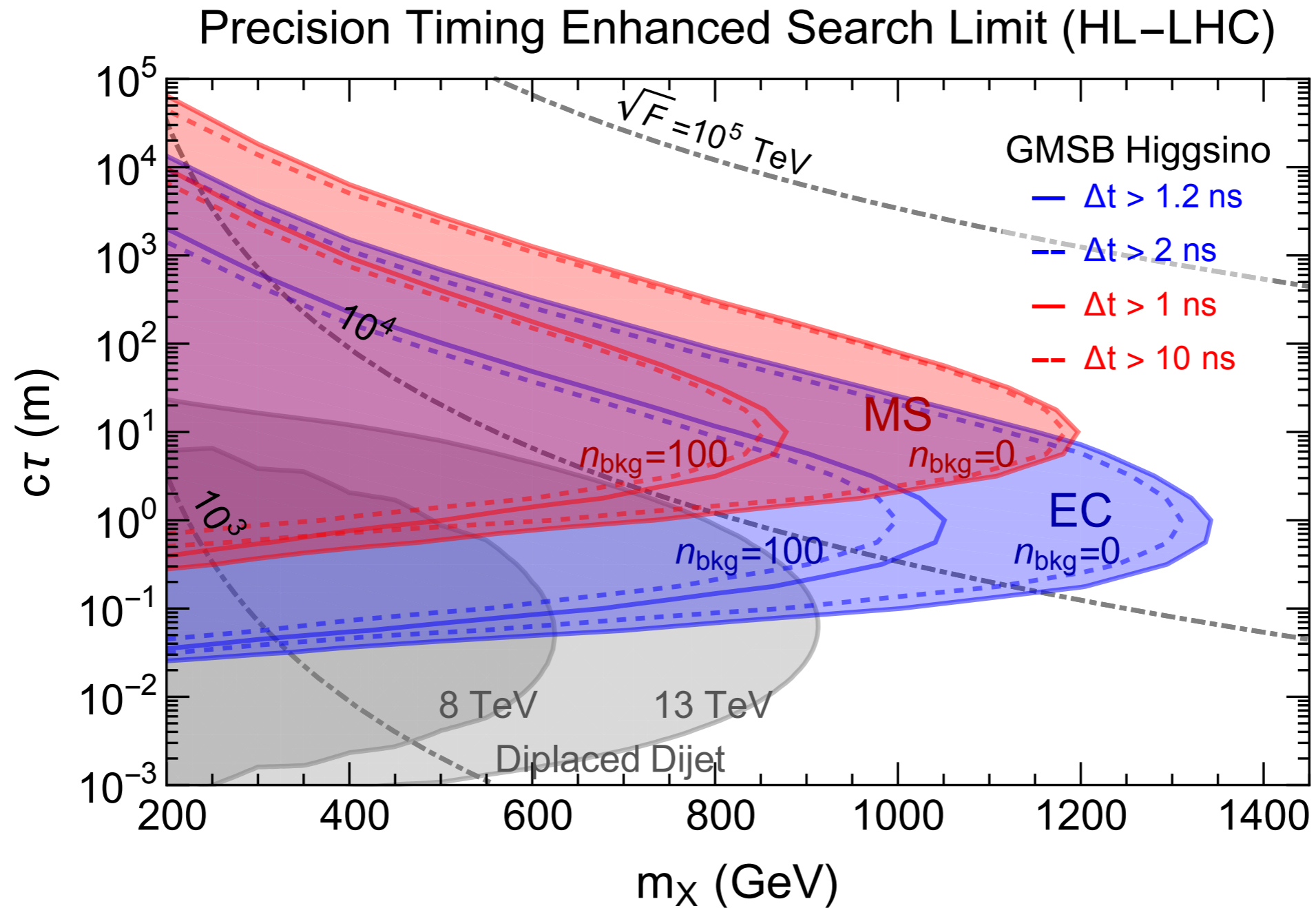

Slower moving LLP, timing cuts can be further relaxed.

stronger
coupling



covered by
current searches

NP too heavy for LHC
with direct production

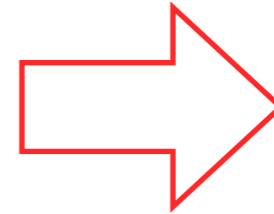

dark sector

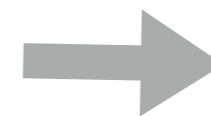

heavier NP
particle

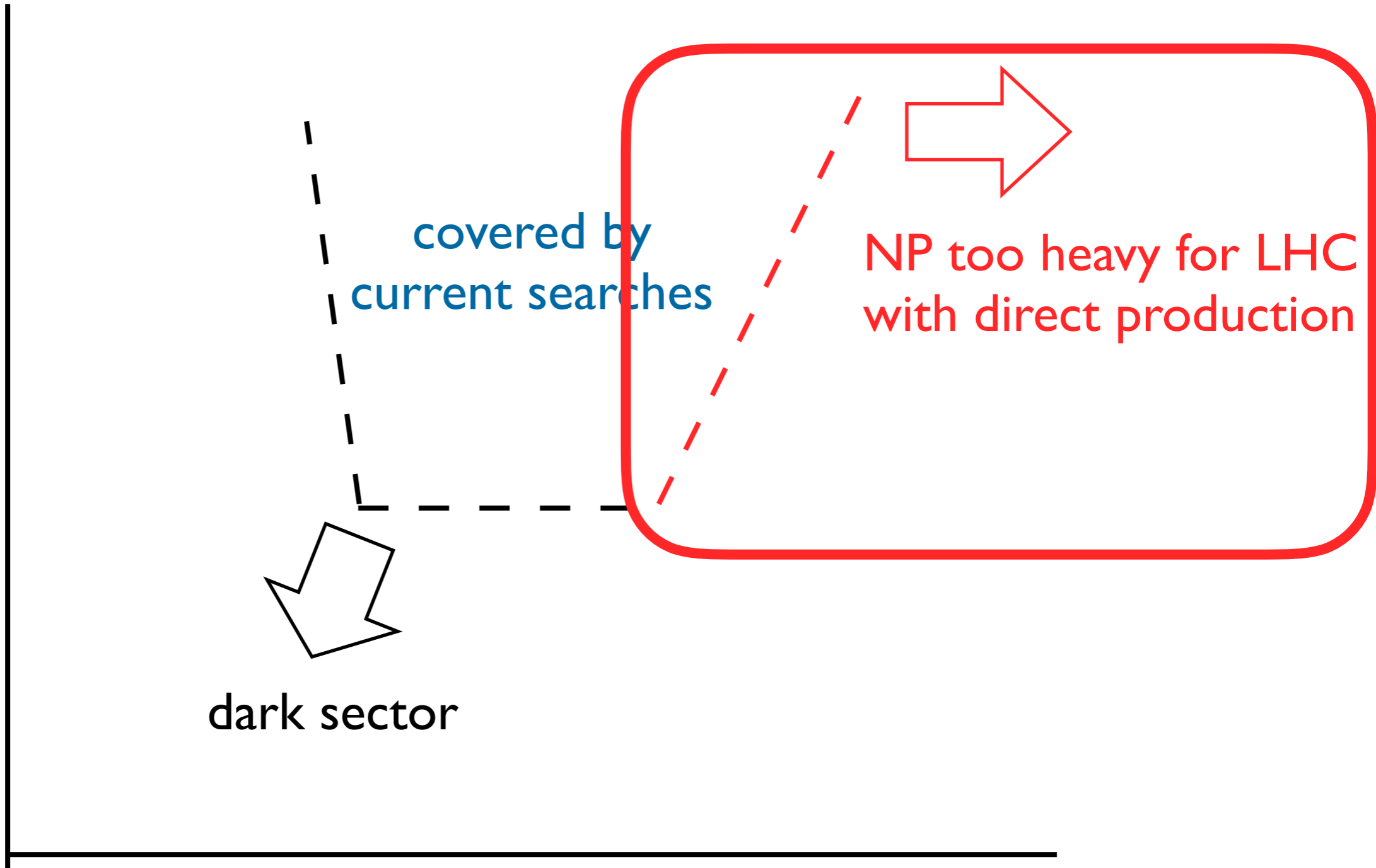

Revealing trace of new physics
with precision measurements

Higgs Standard Model-like

[JHEP 08 (2016) 045]

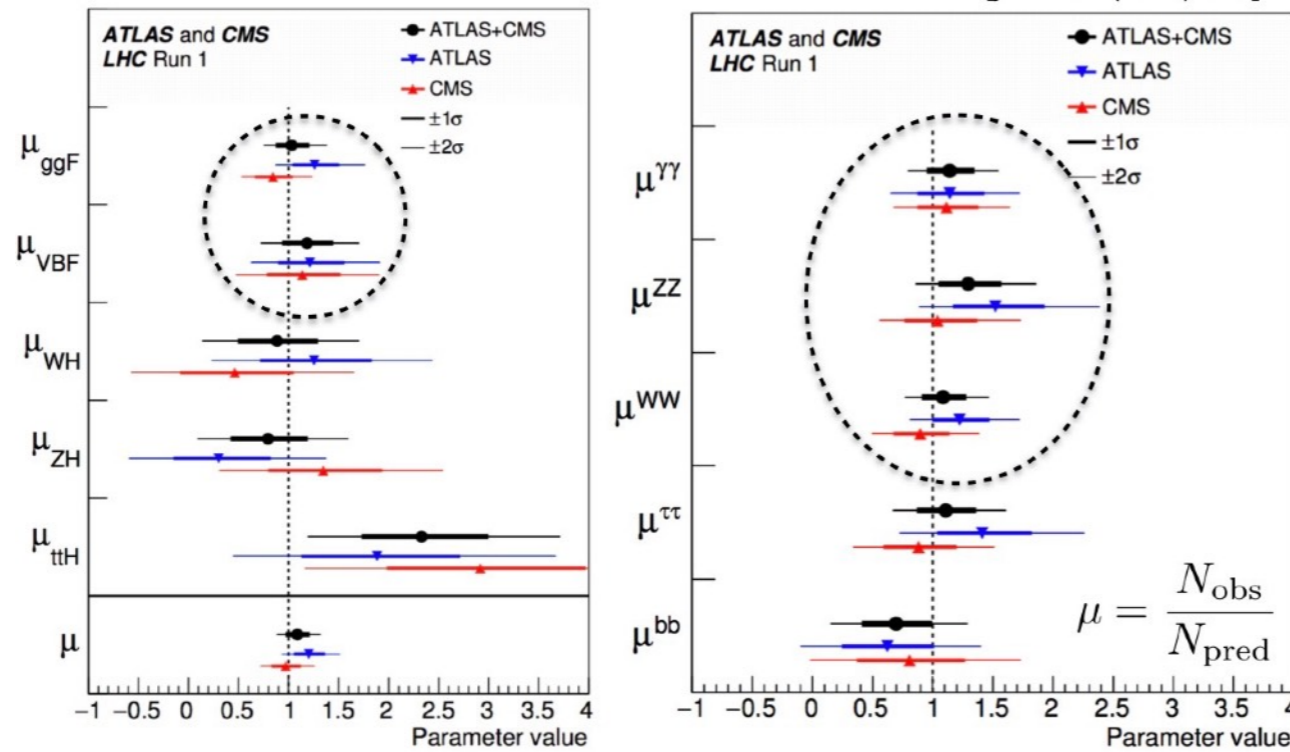

Agree to about
10-20%

ATLAS Preliminary $\sqrt{s}=13$ TeV, 36.1 fb^{-1}
 $H \rightarrow \gamma\gamma$, $m_H = 125.09$ GeV

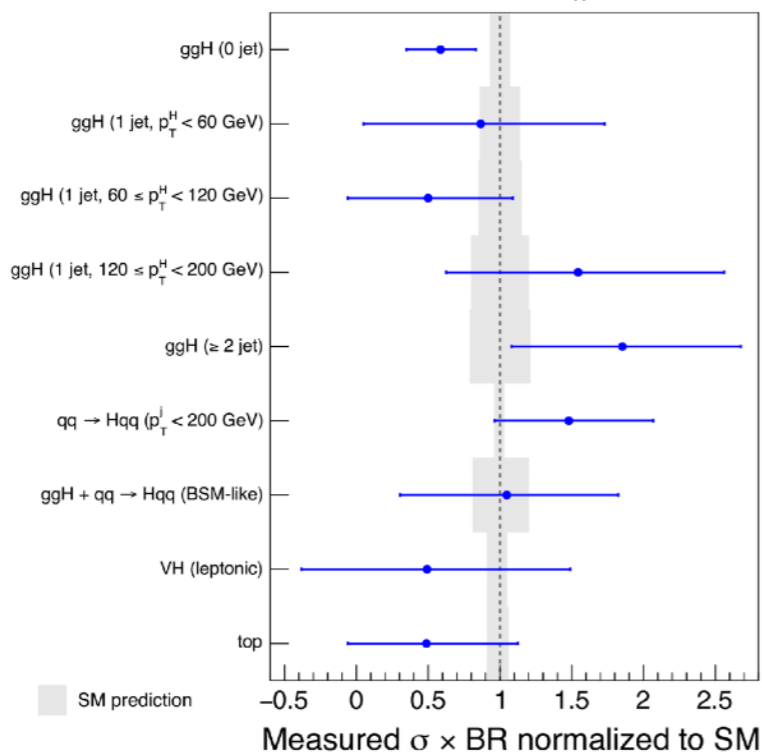

CMS Preliminary 35.9 fb^{-1} (13 TeV)

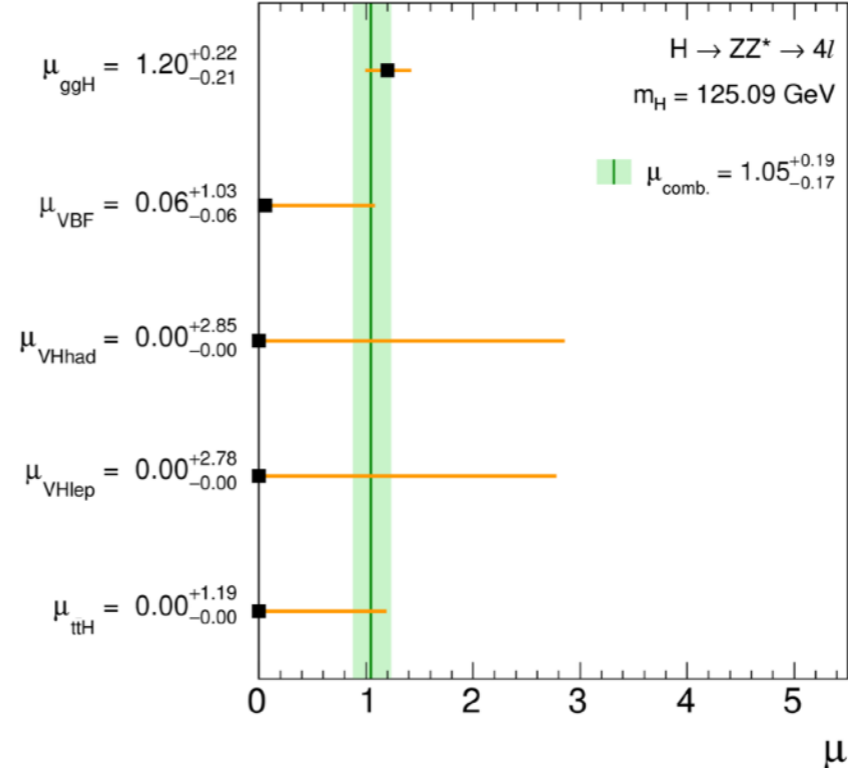

Not entirely surprising

- In general, deviation induced by new physics is of the form

$$\delta \simeq c \frac{v^2}{M_{\text{NP}}^2}$$

M_{NP} : mass of new physics
c: O(1) coefficient

- ▶ Current LHC precision: 10%
⇒ sensitive to $M_{\text{NP}} < 500\text{--}700$ GeV
- ▶ At the same time, direct searches constrain new physics below TeV already.
- ▶ **Unlikely to see O(1) deviation.**

Significant improvement with high lumi

ATLAS Simulation Preliminary

$\sqrt{s} = 14$ TeV: $\int L dt = 300 \text{ fb}^{-1}$; $\int L dt = 3000 \text{ fb}^{-1}$

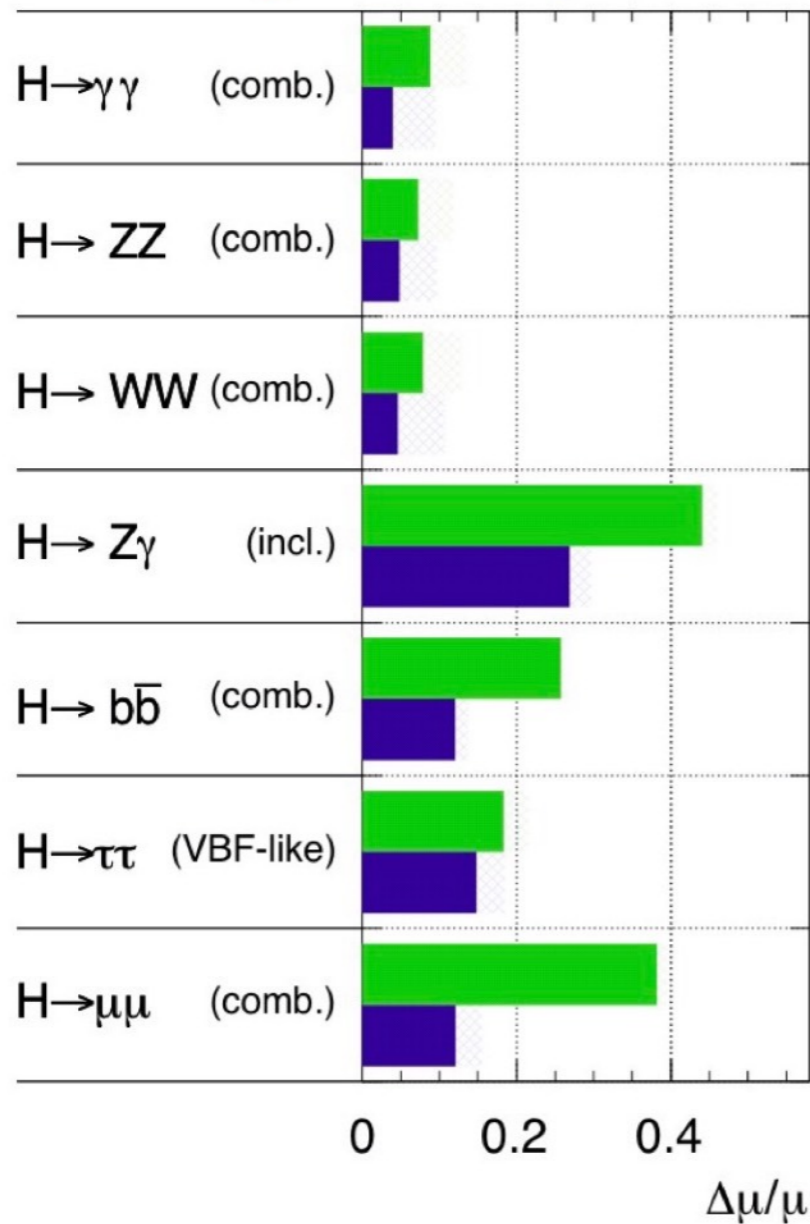

ATLAS Simulation Preliminary

$\sqrt{s} = 14$ TeV: $\int L dt = 300 \text{ fb}^{-1}$; $\int L dt = 3000 \text{ fb}^{-1}$

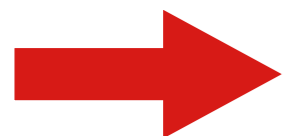
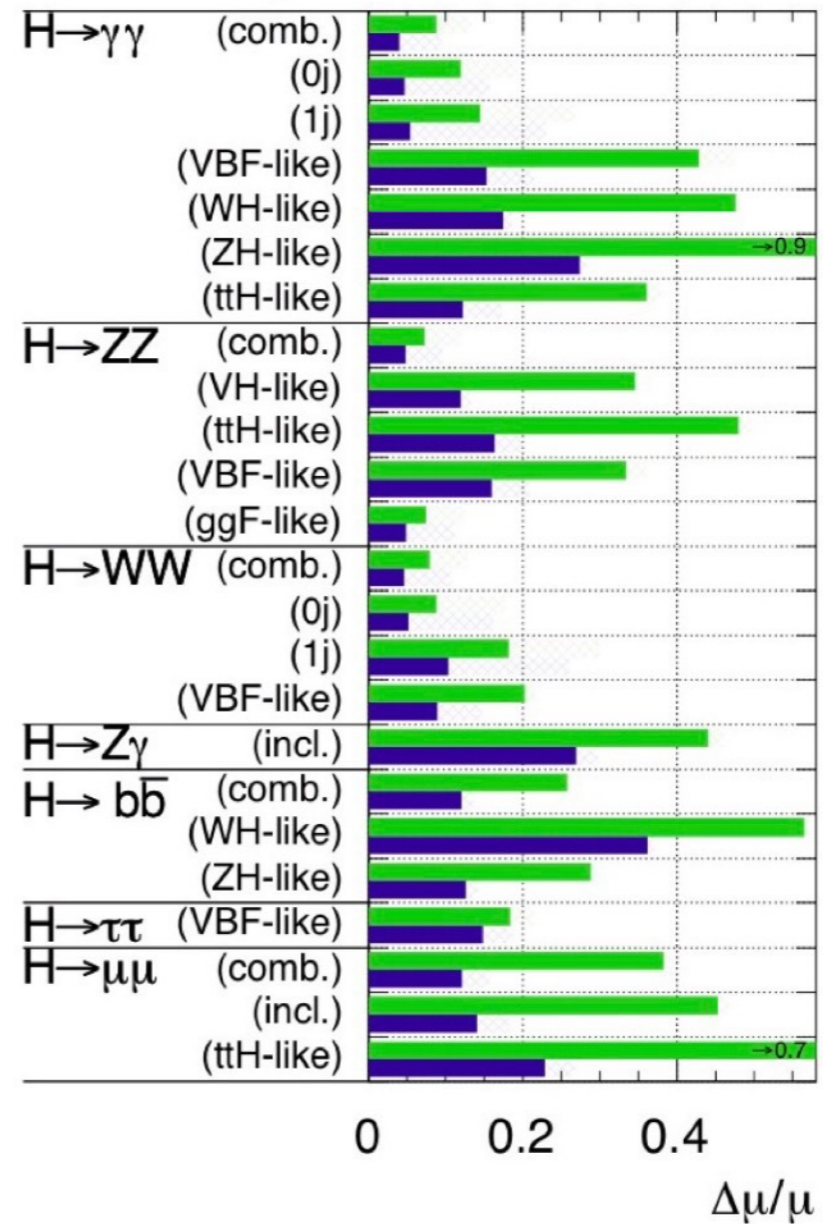

4-5% on Higgs coupling, reach TeV new physics

Precision measurement with distribution

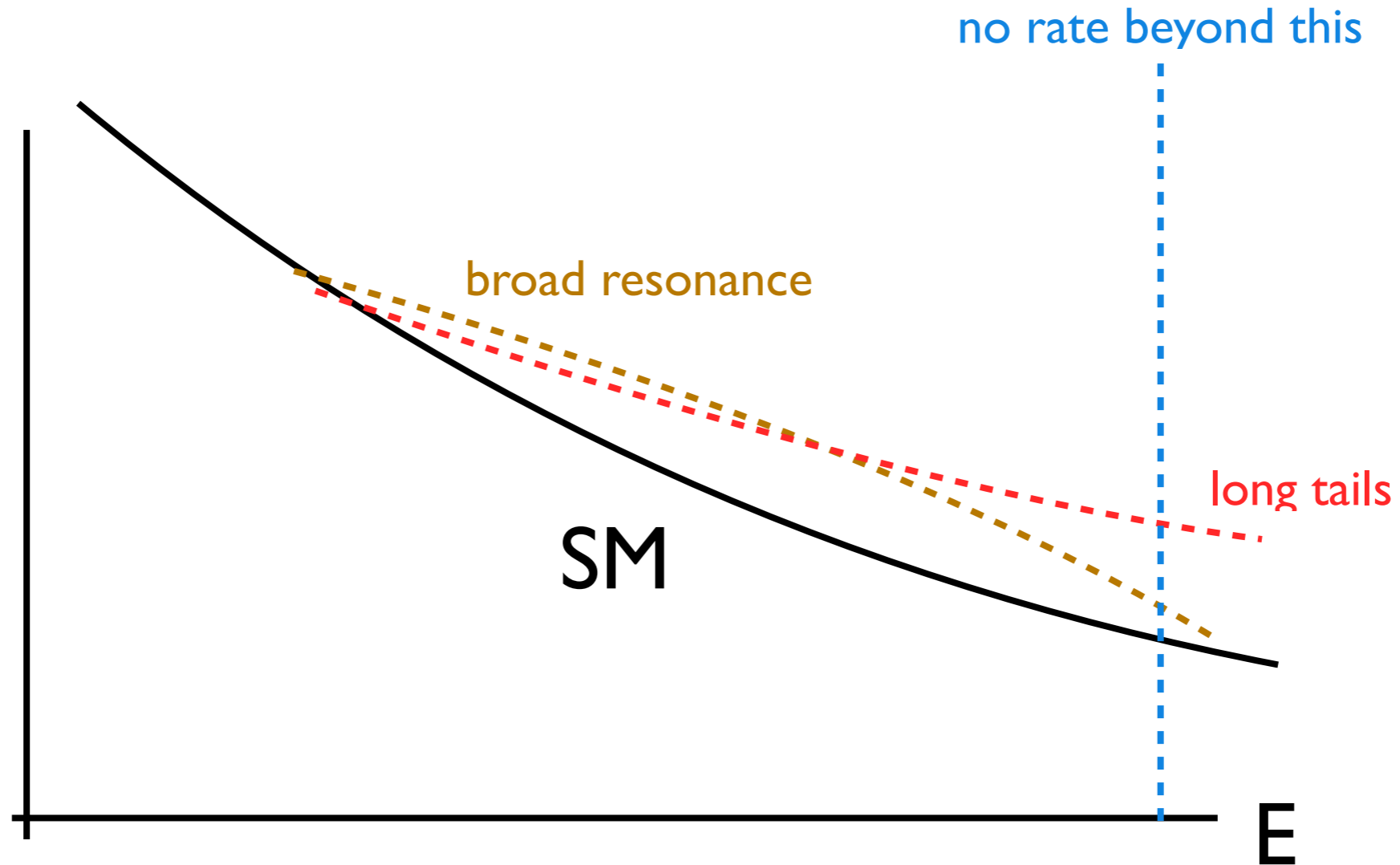

Low S/B, systematic dominated.

Room to improve.

Diboson production at the LHC

$$q\bar{q} \rightarrow VV, \quad V = W, Z, h.$$

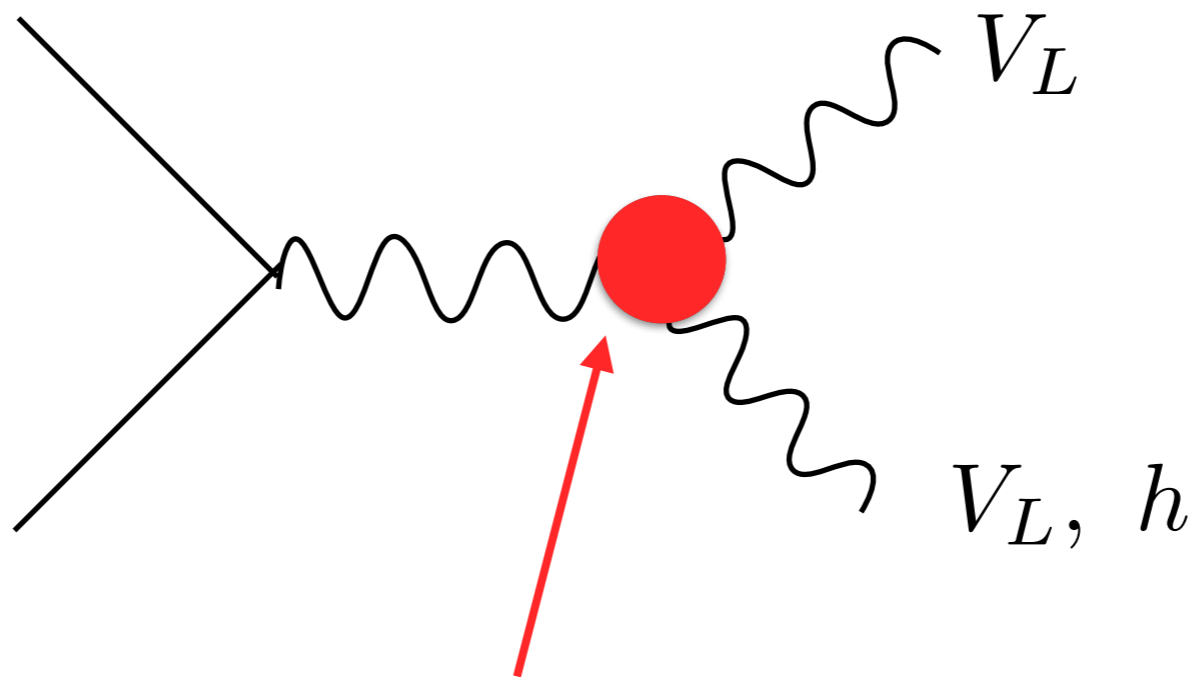

New physics contribution

New physics effect encoded in the non-renormalizable operators:

$$\frac{1}{\Lambda^2} \mathcal{O}$$

Λ : new physics scale

Precision measurement at the LHC possible?

LEP precision tests probe NP about 2 TeV

$$\frac{\delta\sigma}{\sigma_{\text{SM}}} \sim \frac{m_W^2}{\Lambda^2} \sim 2 \times 10^{-3} \quad \rightarrow \quad \Lambda \geq 2 \text{ TeV}$$

At LHC, new physics effect grows with energy

$$\frac{\delta\sigma}{\sigma_{\text{SM}}} \sim \frac{E^2}{\Lambda^2} \sim 0.25 \quad E \sim 1 \text{ TeV}, \quad \Lambda \sim 2 \text{ TeV}$$

LHC needs to make a 20% measurement to beat LEP
LHC has potential.

Operators: d=6

name	structure	coefficient (power counting)
\mathcal{O}_H	$\frac{1}{2} (\partial_\mu H ^2)^2$	c_H/f^2
\mathcal{O}_y	$y \bar{Q}_L H u_R H ^2$	c_y/f^2
\mathcal{O}_W	$ig \left(H^\dagger \sigma^a \overleftrightarrow{D}^\mu H \right) D^\nu W_{\mu\nu}^a$	c_W/m_*^2
\mathcal{O}_B	$ig' (H^\dagger \overleftrightarrow{D}^\mu H) D^\nu B_{\mu\nu}$	c_B/m_*^2
\mathcal{O}_{HW}	$ig (D^\mu H)^\dagger \sigma^a (D^\nu H) W_{\mu\nu}^a$	$c_{HW}/m_*^2 \times (g_*/4\pi)^2$
\mathcal{O}_{HB}	$ig' (D^\mu H)^\dagger (D^\nu H) B_{\mu\nu}$	$c_{HB}/m_*^2 \times (g_*/4\pi)^2$
O_L^q	$ig^2 (H^\dagger \overleftrightarrow{D}_\mu H) \bar{Q}_L \gamma^\mu Q_L$	$c_q/m_*^2 \times \epsilon_q^2$
$O_L^{q,3}$	$ig^2 (H^\dagger \sigma^a \overleftrightarrow{D}_\mu H) \bar{Q}_L \sigma^a \gamma^\mu Q_L$	$c_{q,3}/m_*^2 \times \epsilon_q^2$
O_R^u	$ig^2 (H^\dagger \overleftrightarrow{D}_\mu H) \bar{u}_R \gamma^\mu u_R$	$c_u/m_*^2 \times \epsilon_u^2$
O_R^d	$ig^2 (H^\dagger \overleftrightarrow{D}_\mu H) \bar{d}_R \gamma^\mu d_R$	$c_d/m_*^2 \times \epsilon_d^2$
O_T	$(H^\dagger \overleftrightarrow{D}_\mu H)^2$	c_T/f^2
\mathcal{O}_6	$ H ^6$	λ_3/f^2

Projections

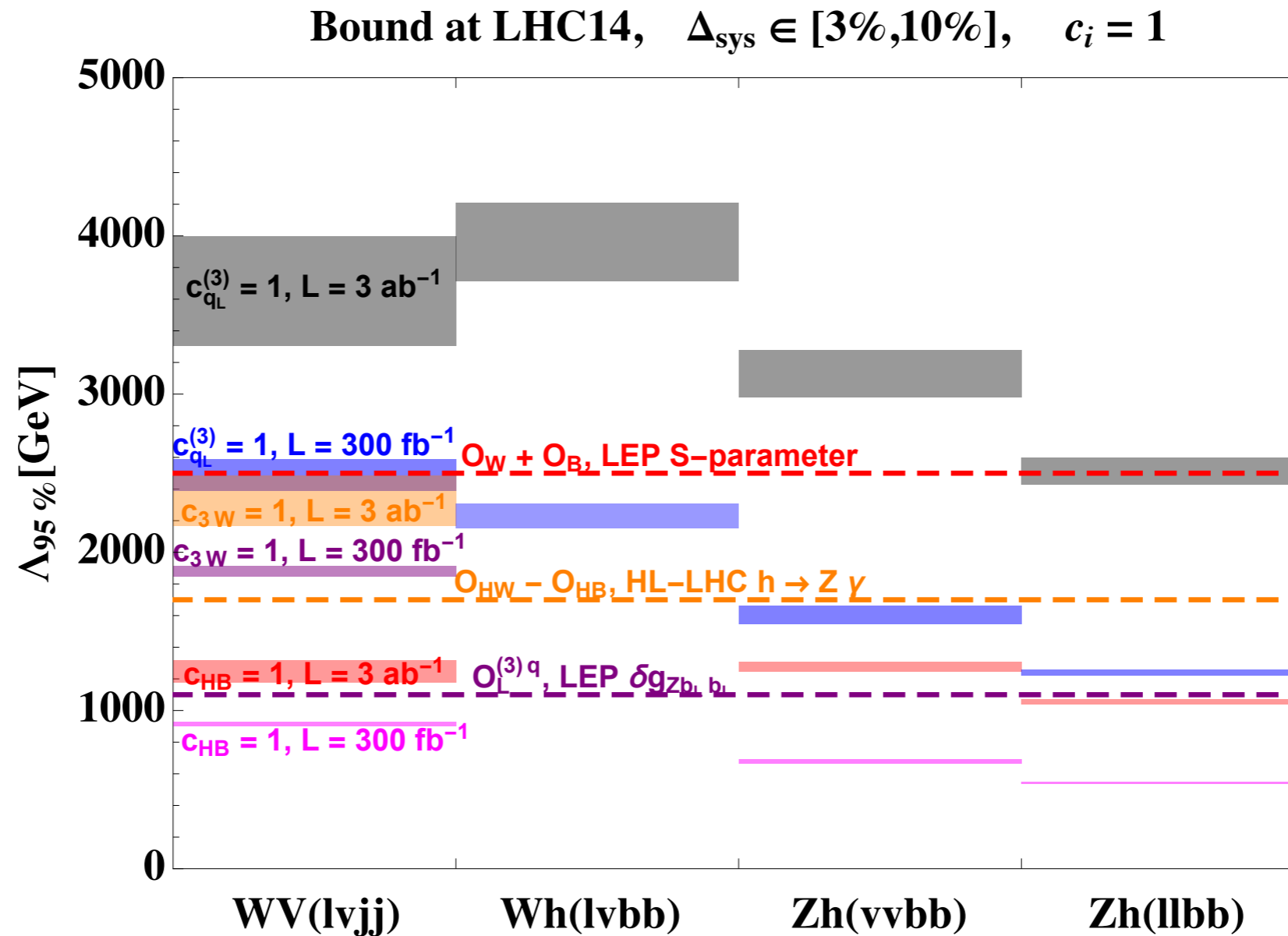

Possible to reach 4 TeV.

D. Liu, LTW

Better than LEP, and many LHC direct searches

See also: Alioli, Farina, Pappadopulo, Ruderman, Franceschini, Panico, Pomarol, Riva, Wulzer, Azatov, Elias-Miro, Regimuaaji, Venturini

Beyond LHC

Future Colliders

ILC in Japan

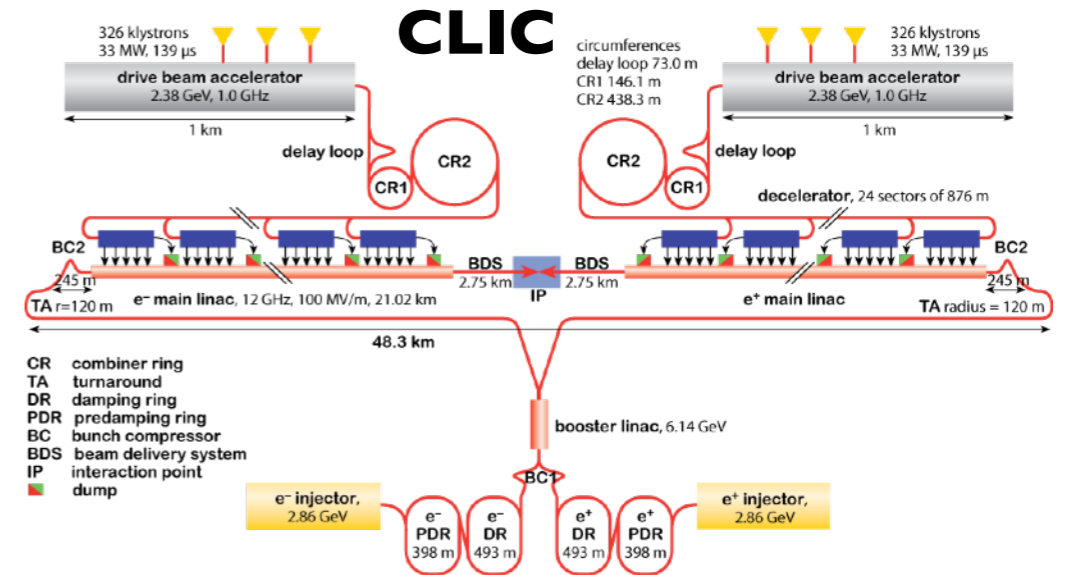
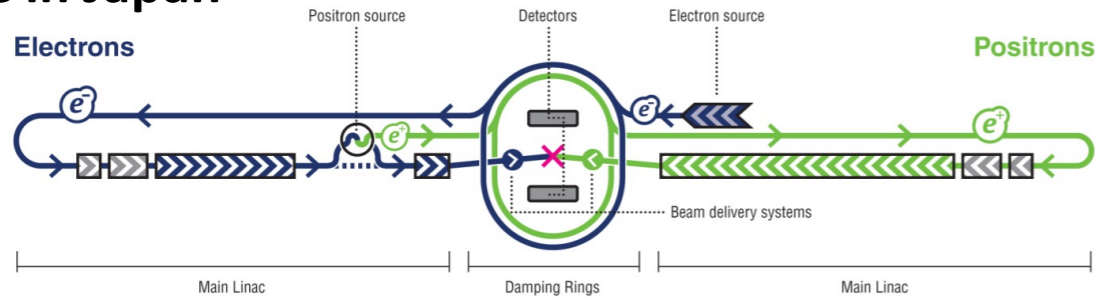

Circular. “Scale up” LEP+LHC

~100 TeV

pp collider

FCC-hh (CERN), SppC(China)

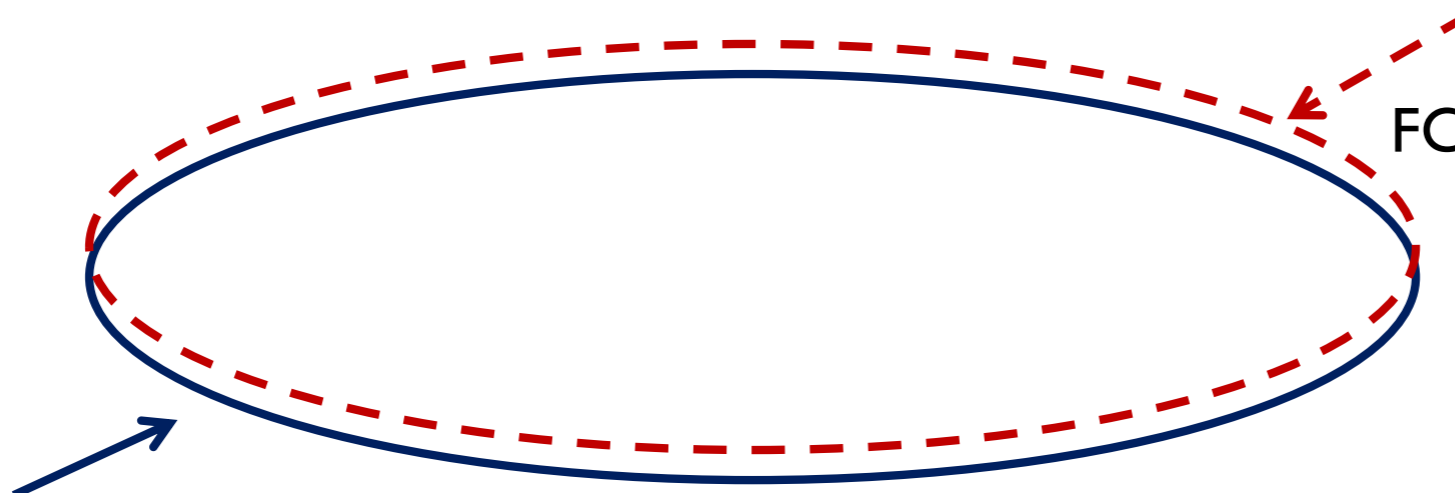

250 GeV **e⁻e⁺ Higgs Factory**

FCC-ee (CERN), CEPC(China)

Lepton colliders and precision measurements

precision reach of the 12-parameter fit in Higgs basis

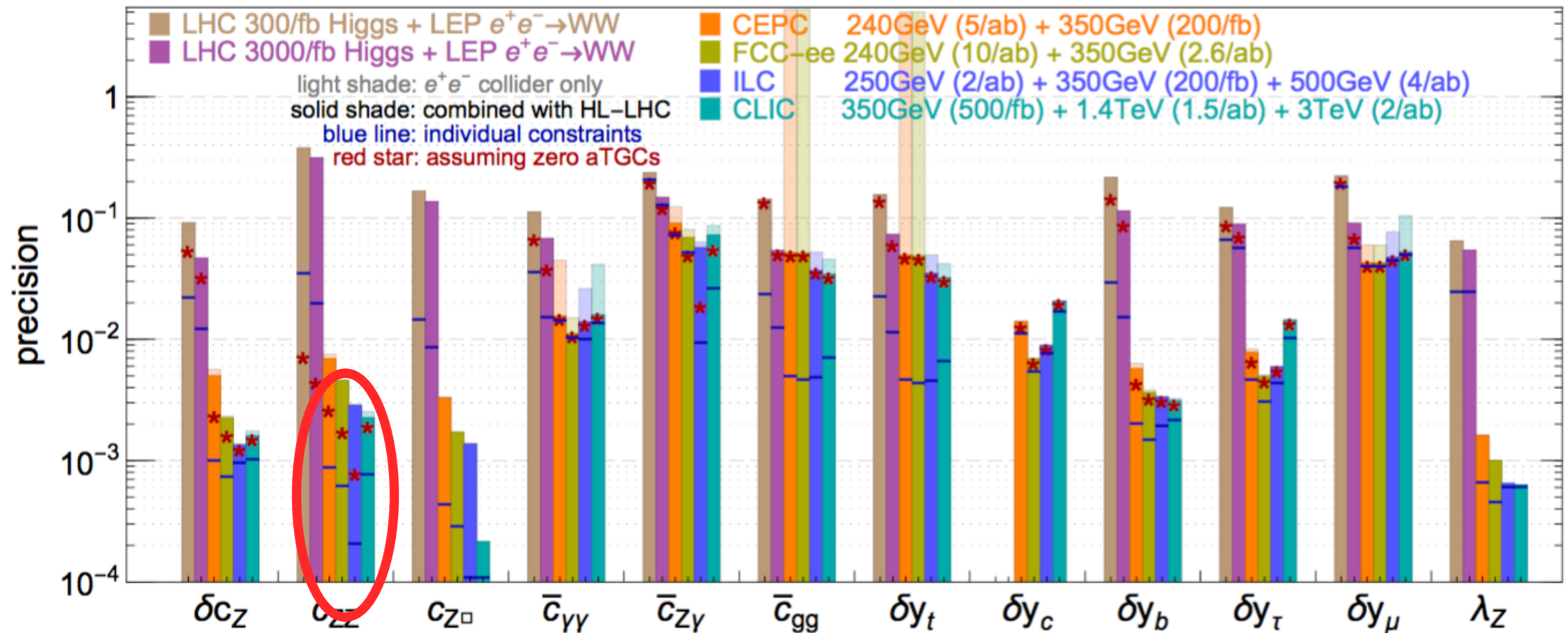

Grojean et al. 1704.02333

Sub percent precision, reach to new physics at multi-TeV scale.
Far beyond the reach of LHC.

Electroweak precision

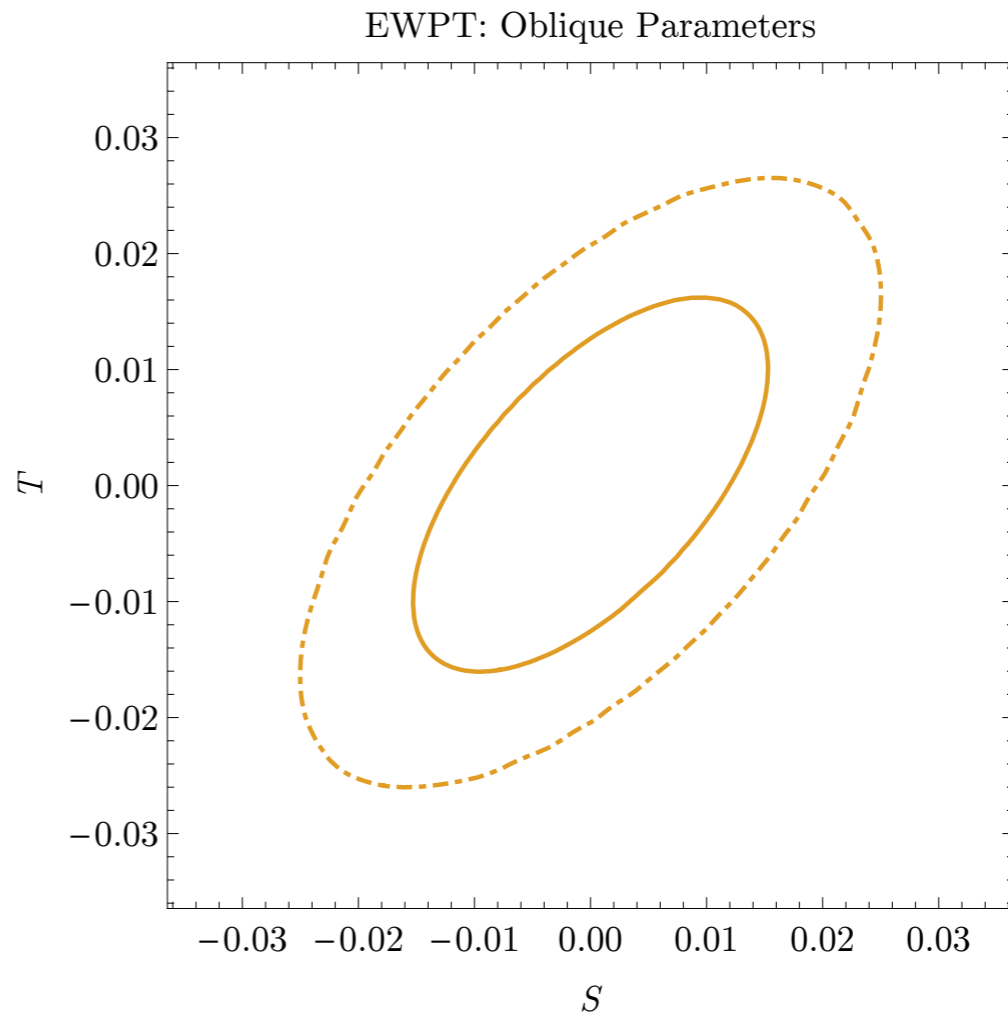
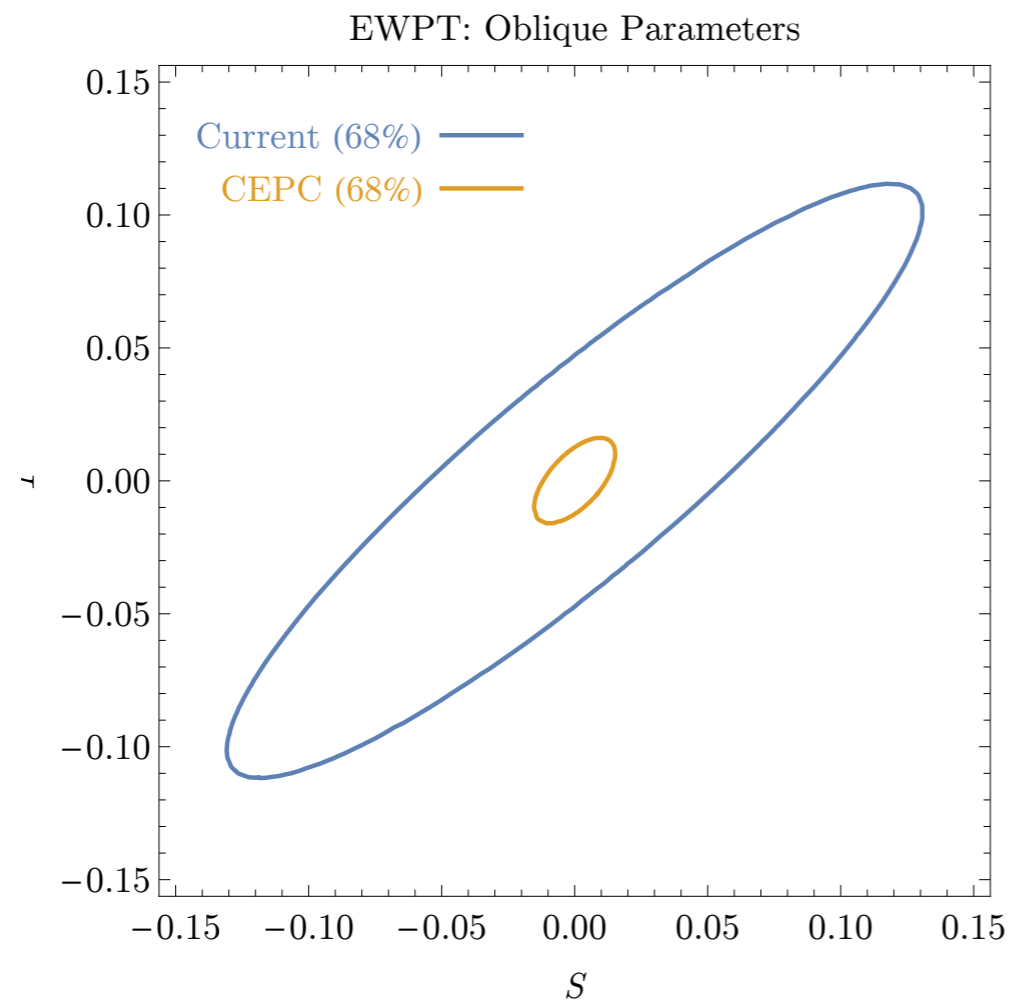

FCC can do even better (by a factor of a few)

100-ish TeV pp collider

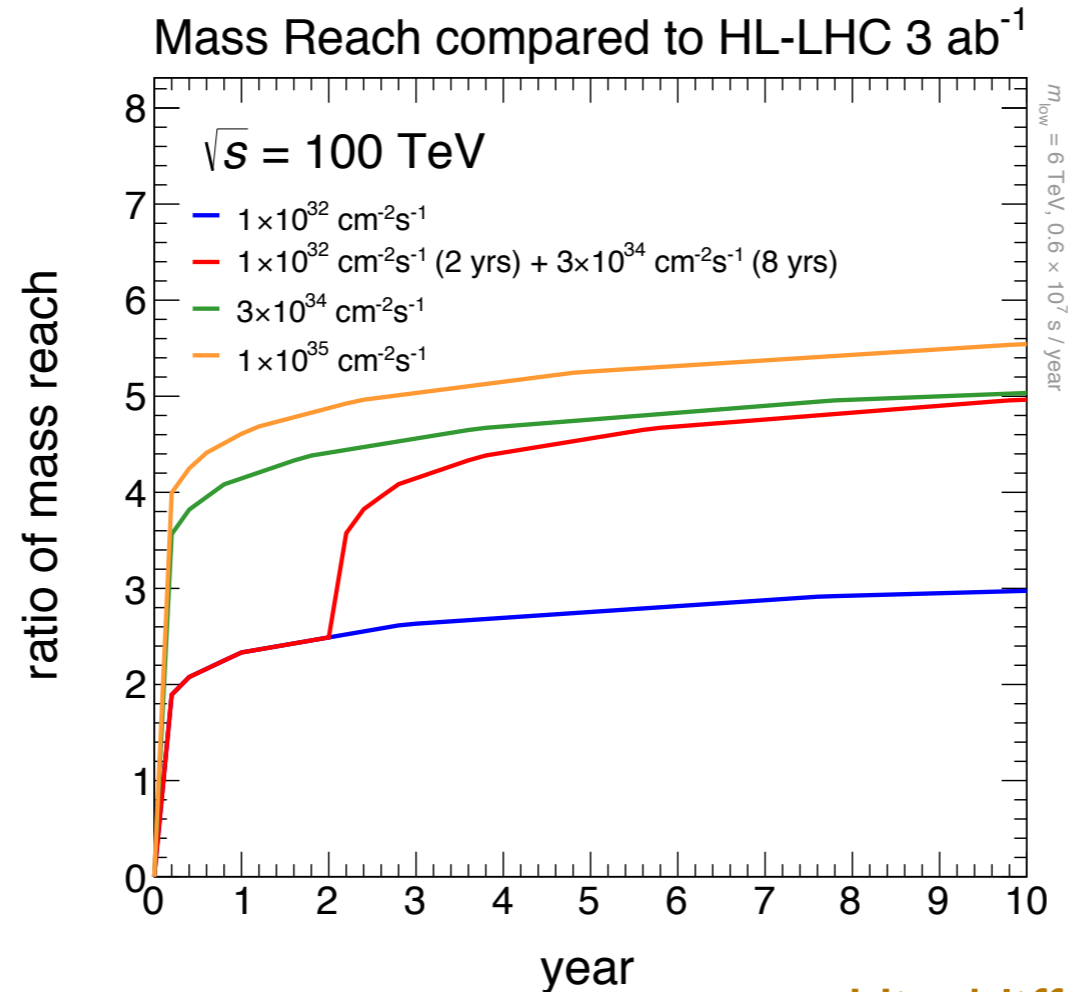

Hinchliffe, Kotwal, Mangano, Quigg, LTW

A factor of at least 5 increase in reach beyond the LHC, with modest luminosity

Electroweak symmetry breaking

“Simple” picture: Mexican hat

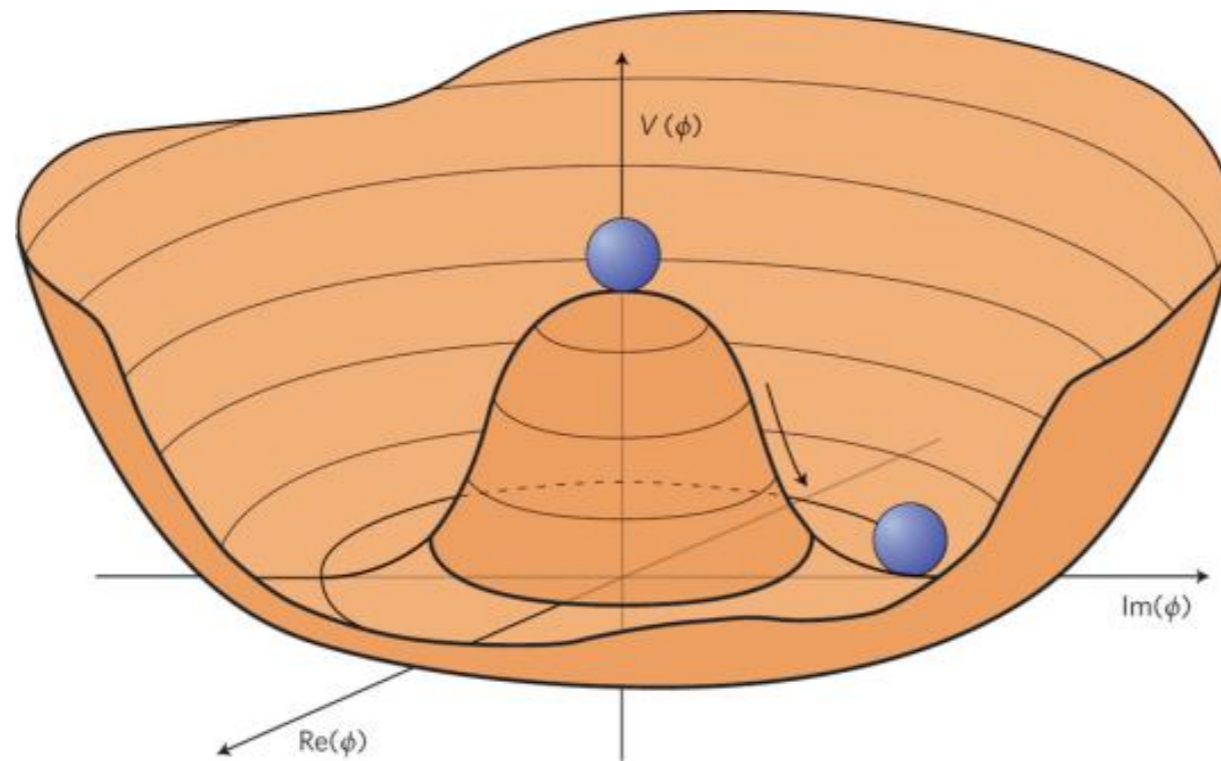

$$V(h) = \frac{1}{2}\mu^2 h^2 + \frac{\lambda}{4}h^4$$

$$\langle h \rangle \equiv v \neq 0 \rightarrow m_W = g_W \frac{v}{2}$$

Similar to, and motivated by Landau-Ginzburg theory of superconductivity.

“Simple” picture: Mexican hat

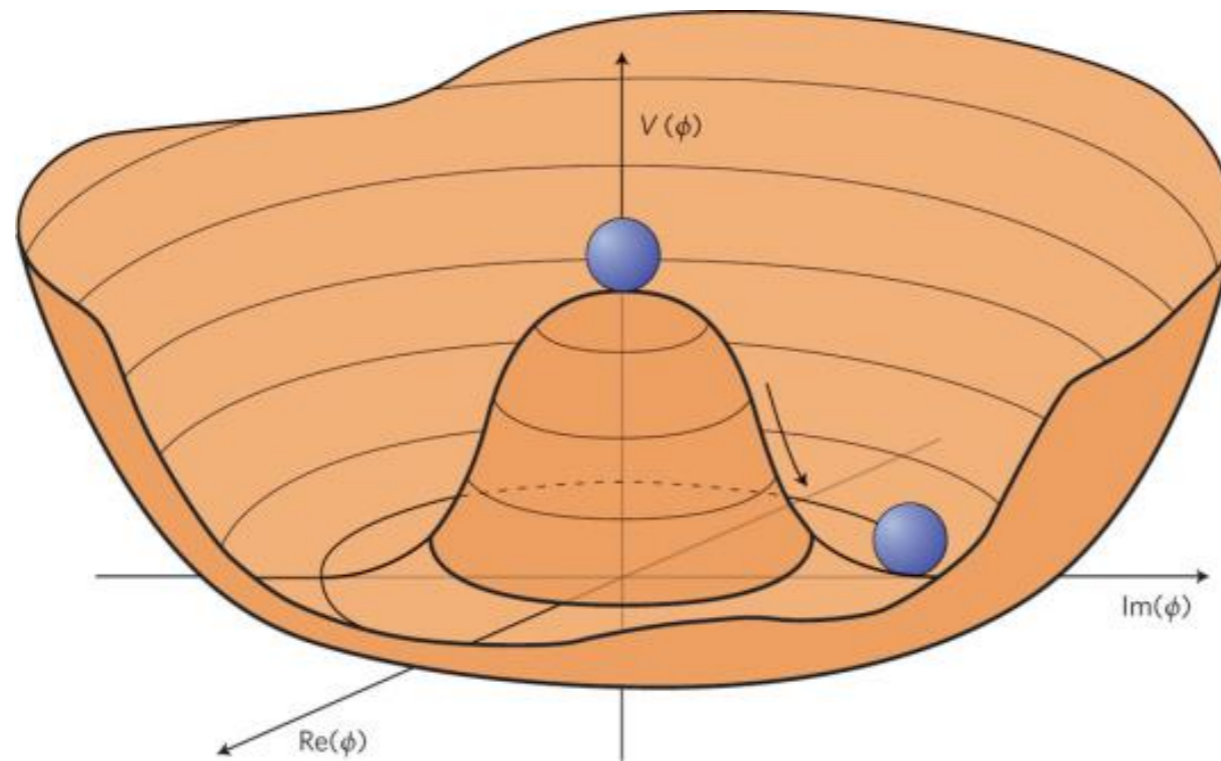

$$V(h) = \frac{1}{2}\mu^2 h^2 + \frac{\lambda}{4} h^4$$
$$\langle h \rangle \equiv v \neq 0 \rightarrow m_W = g_W \frac{v}{2}$$

Similar to, and motivated by
Landau-Ginzburg theory
of superconductivity.

However, this simplicity is deceiving.
Parameters not predicted by theory. Can not be the complete picture.

Mysteries of the electroweak scale.

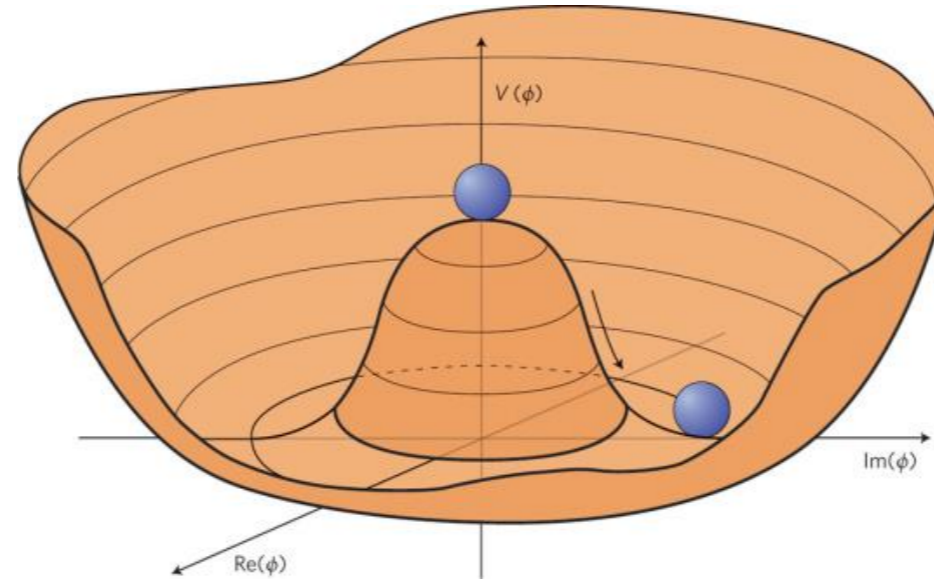

Mysteries of the electroweak scale.

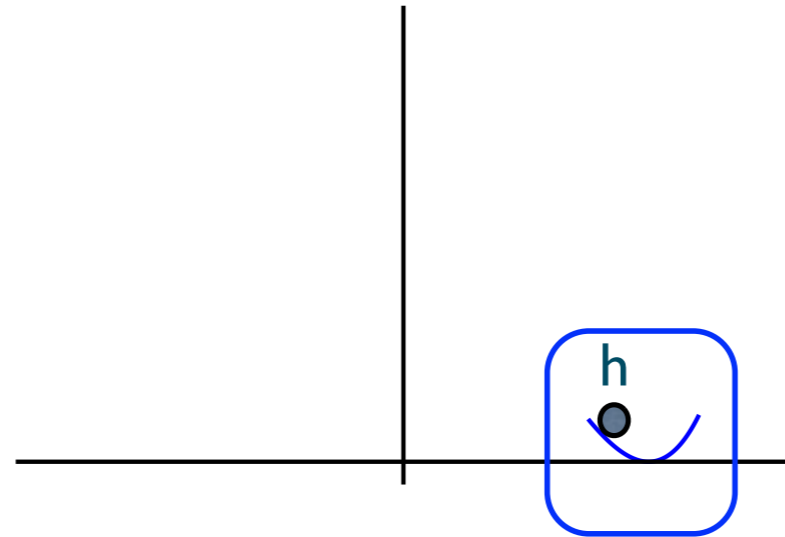

What we know now

Mysteries of the electroweak scale.

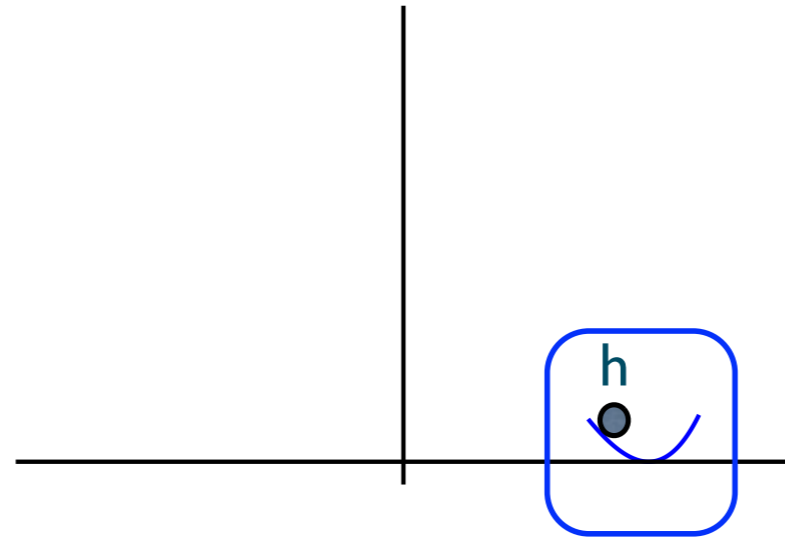

What we know now

- How to predict/calculate Higgs mass? Naturalness
- Full Higgs potential?
 - Order of electroweak phase transition

How to predict Higgs mass?

.....

The energy scale of new physics
responsible for EWSB



Electroweak scale, 100 GeV.

m_h , m_W ...

How to predict Higgs mass?

.....

The energy scale of new physics
responsible for EWSB

What is this energy scale?

$M_{\text{Planck}} = 10^{19} \text{ GeV}, \dots?$

If so, why is so different from 100 GeV?
The so called naturalness problem



Electroweak scale, 100 GeV.

$m_h, m_W \dots$

Naturalness of electroweak symmetry breaking



The energy scale of new physics
responsible for EWSB

TeV new physics.
Naturalness motivated
Many models, ideas.



Electroweak scale, 100 GeV.
 $m_h, m_W \dots$

Naturalness in SUSY

- LHC searches model dependent, many blind spots.

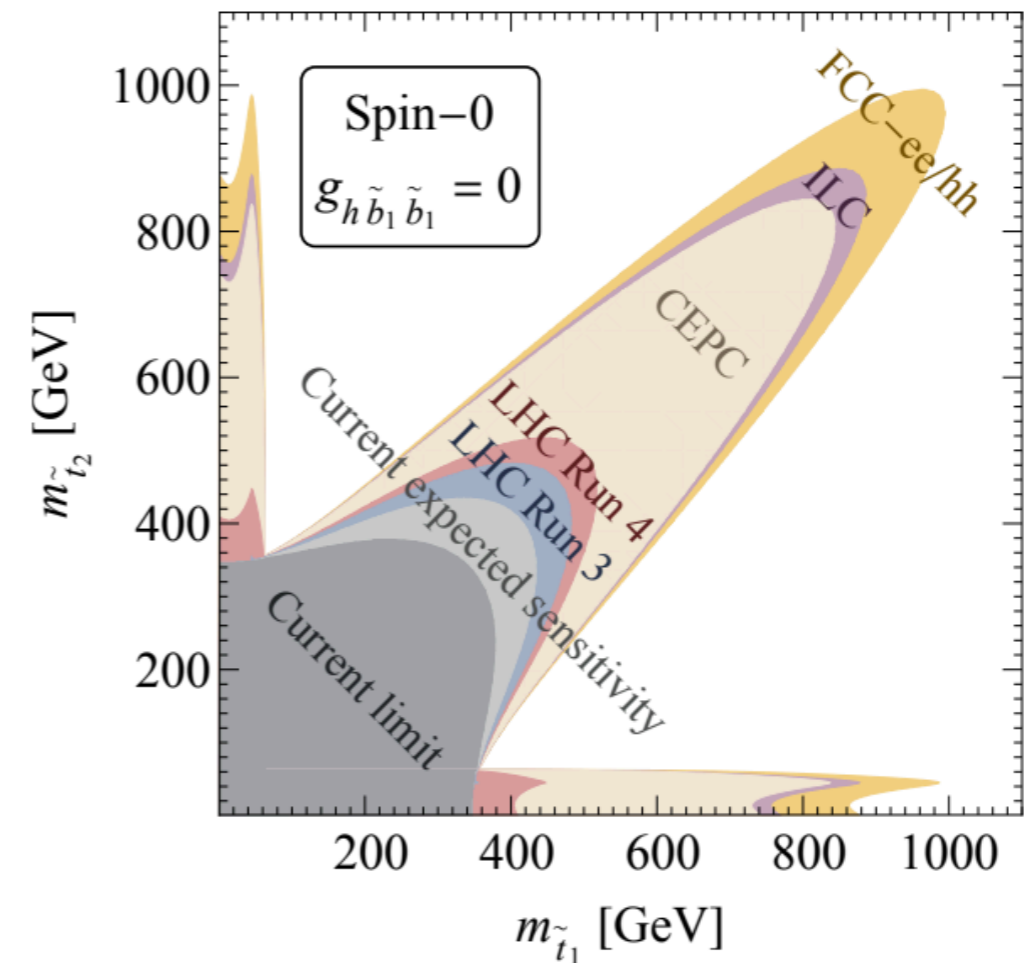
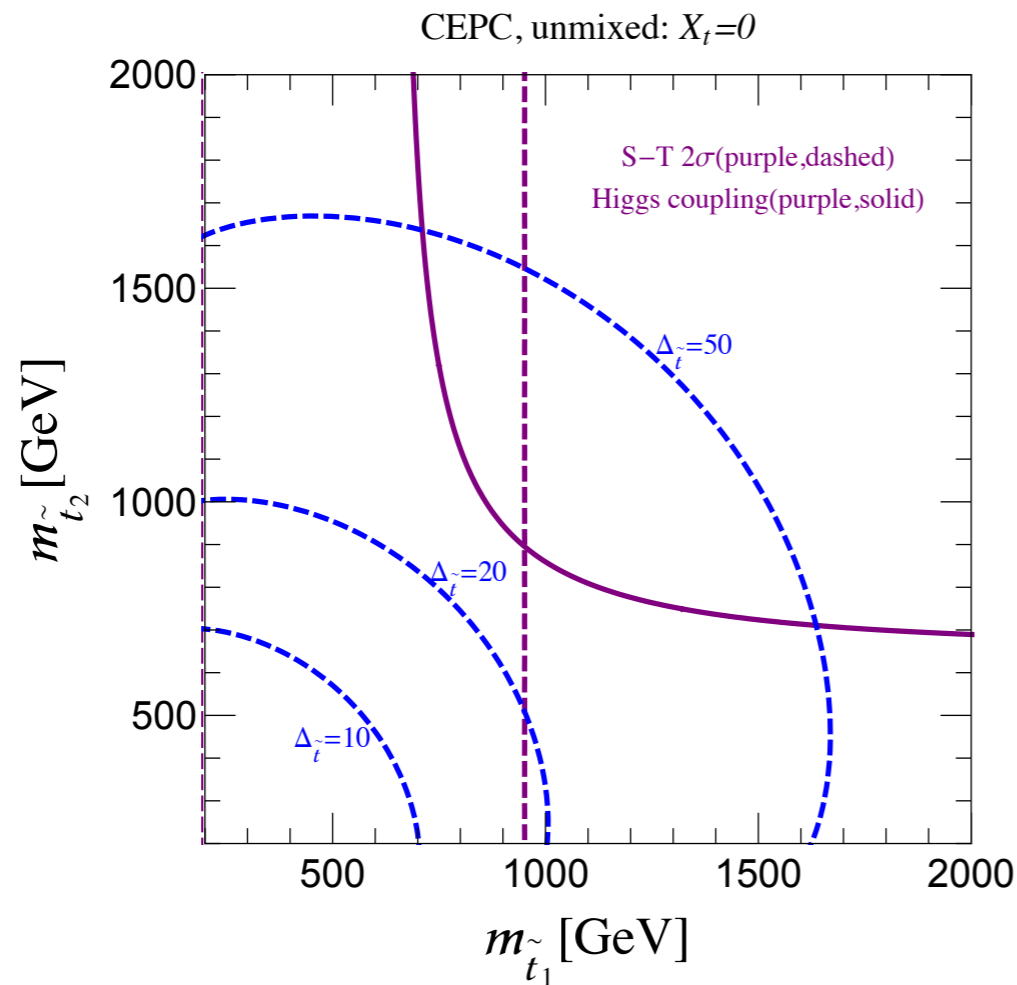

- Testing fine-tuning down to percent level.

Testing naturalness: Supersymmetry

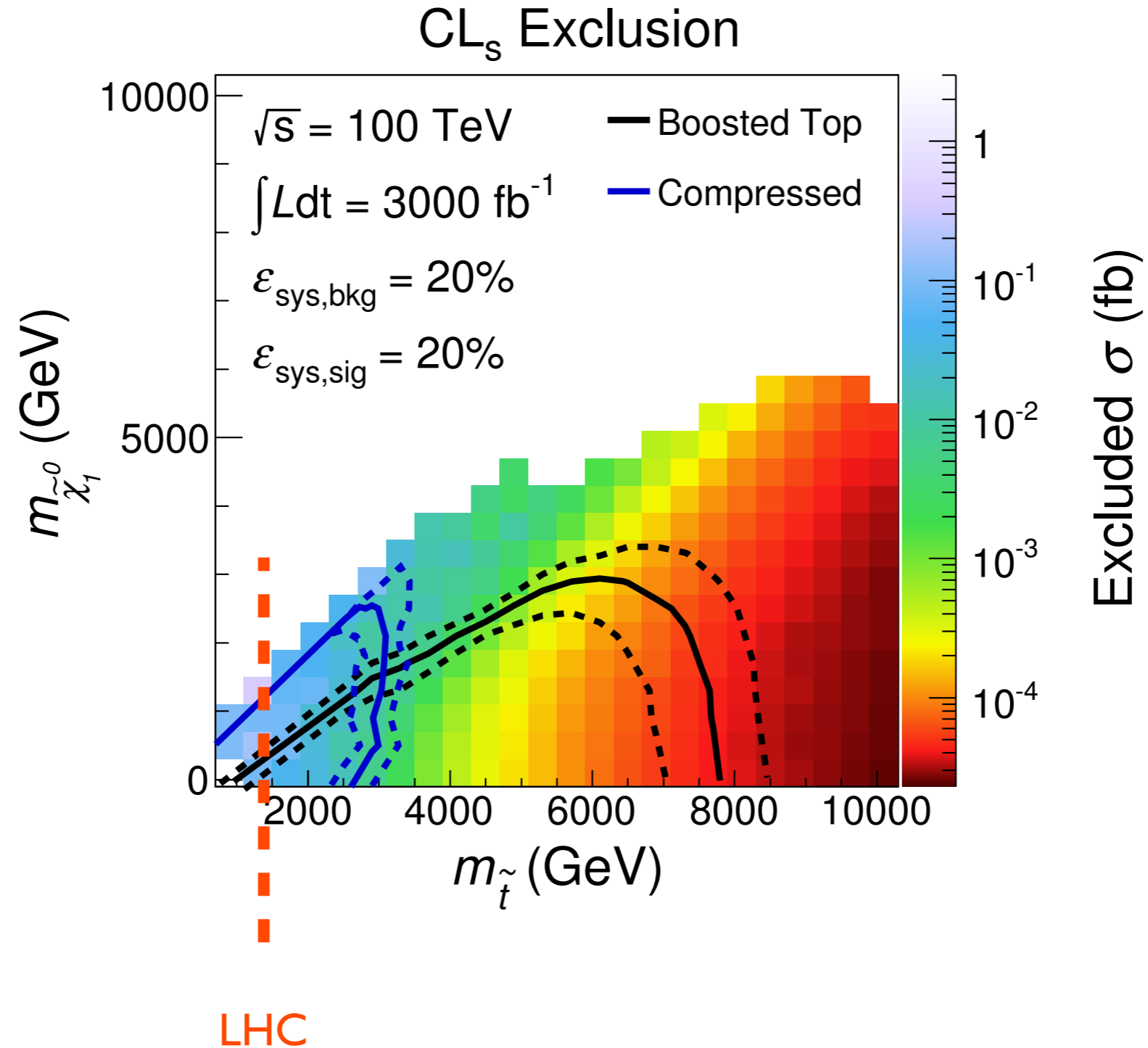

Composite Higgs

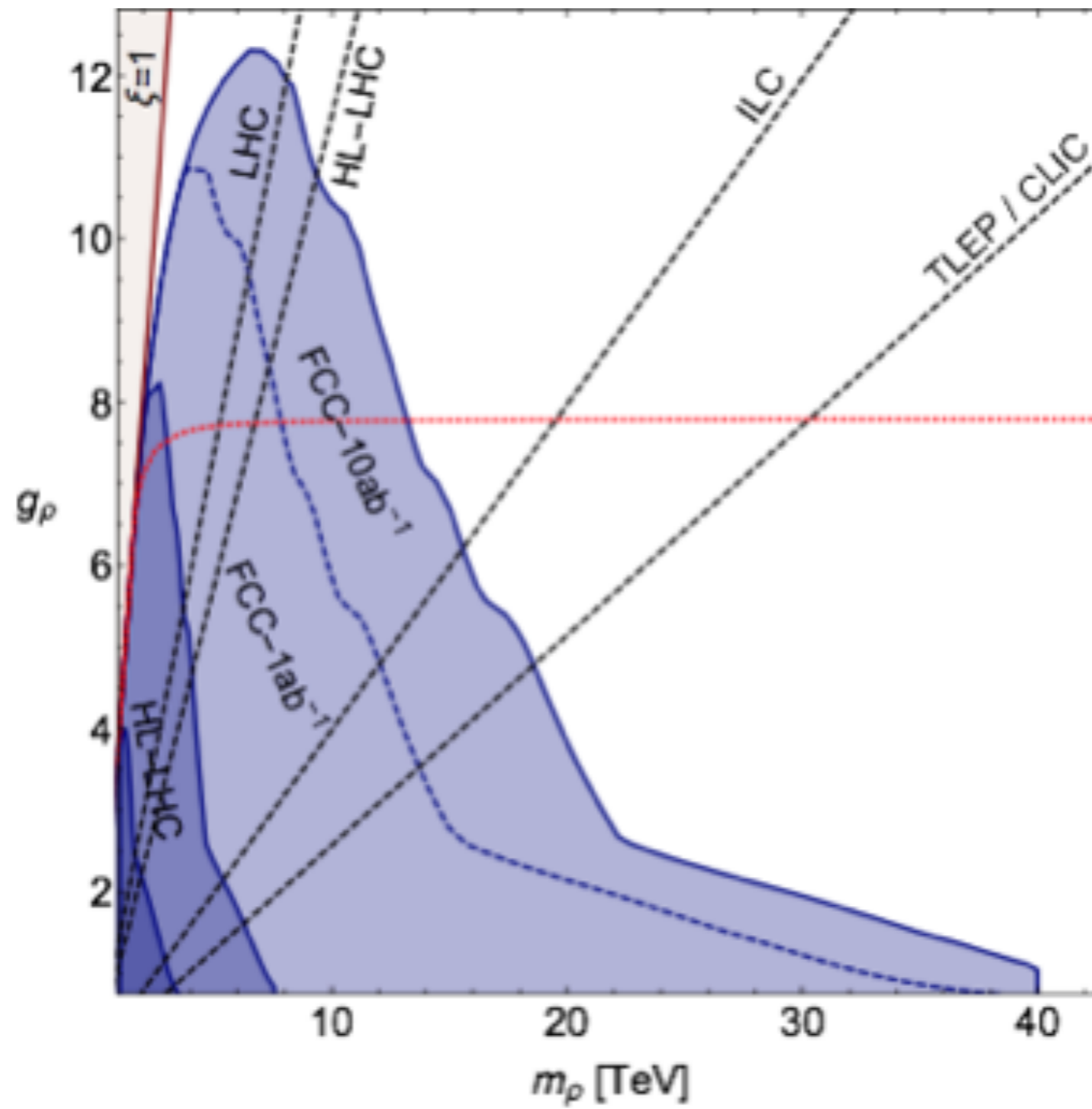

Why is Higgs measurement crucial?

- Naturalness is the most pressing question of EWSB.
 - ▶ How should we predict the Higgs mass?
- We may not have the right idea. No confirmation of any of the proposed models.
- Need experiment!
- Fortunately, with Higgs, we know where to look.
- And, the clue to any possible way to address naturalness problem must show up in Higgs coupling measurement.

Mysteries of the electroweak scale.

Mysteries of the electroweak scale.

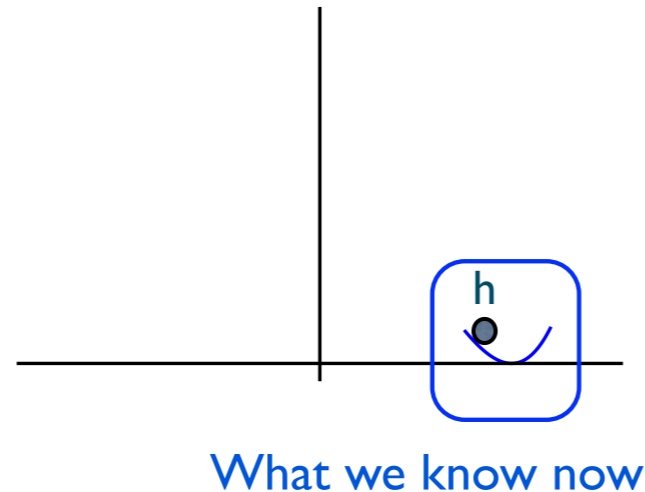

- How to predict/calculate Higgs mass?
- What does the rest of the Higgs potential look like? Nature of electroweak phase transition.
- Is it connected to the matter anti-matter asymmetry?

Mysteries of the electroweak scale.

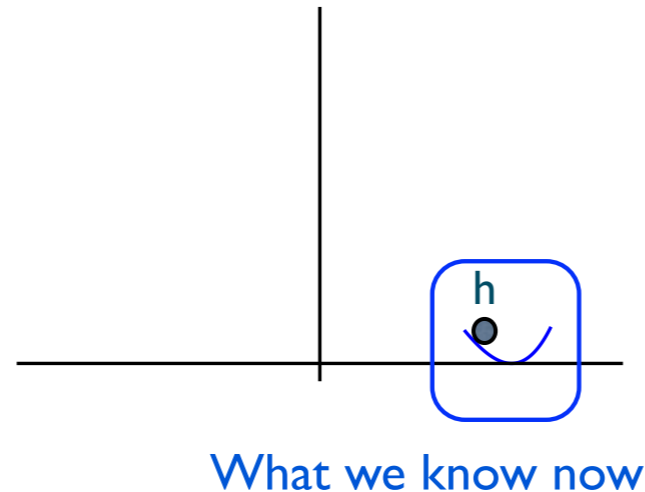

- How to predict/calculate Higgs mass?
- What does the rest of the Higgs potential look like? Nature of electroweak phase transition.
- Is it connected to the matter anti-matter asymmetry?

Nature of EW phase transition

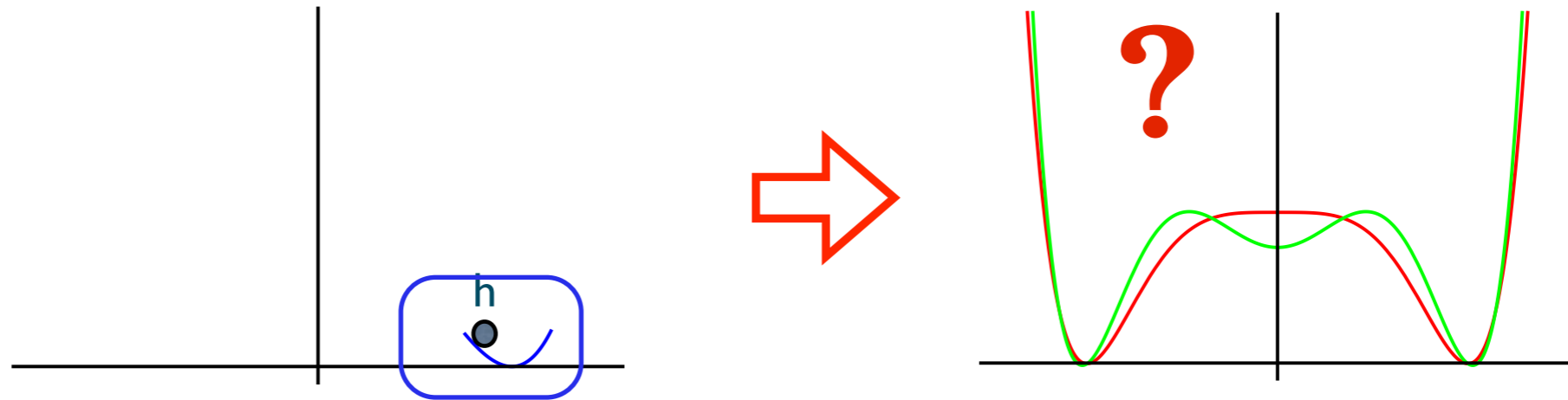

What we know from LHC
LHC upgrades won't go much further

“wiggles” in Higgs potential

Big difference in triple Higgs coupling

Triple Higgs coupling at 100 TeV collider

Precision on the self-coupling

assuming QCD can be measured from sidebands

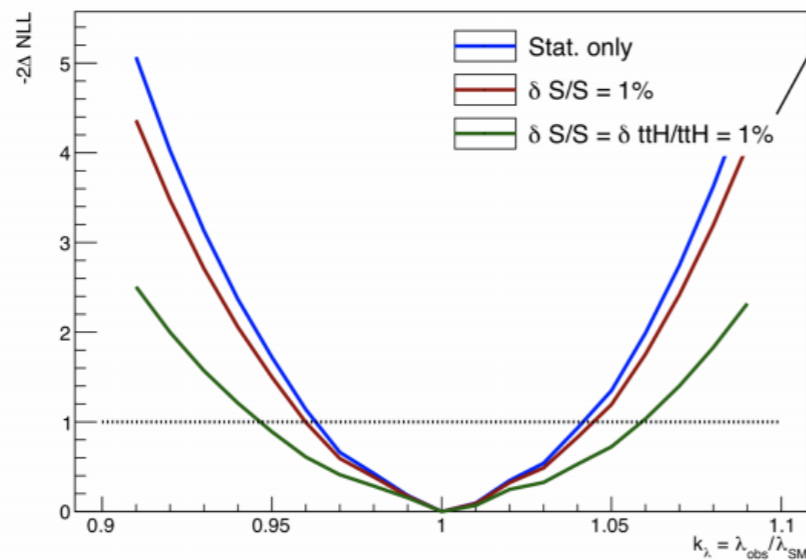

nominal background yields:

$$\begin{aligned} \delta k_\lambda(\text{stat}) &\approx 3.5\% \\ \delta k_\lambda(\text{stat} + \text{syst}) &\approx 6\% \end{aligned}$$

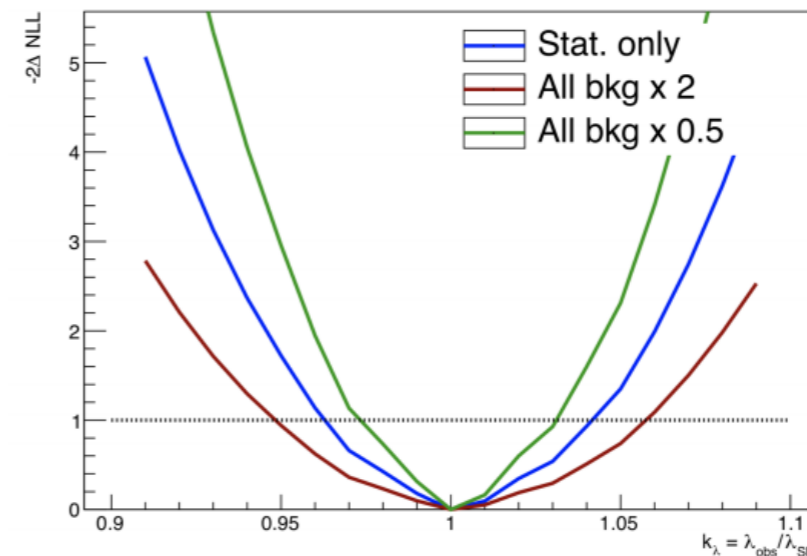

varying (0.5x-2x) background yields:

$$\delta k_\lambda(\text{stat}) \approx 3 - 5\%$$

But, there should be more

$$V(h) = \frac{m^2}{2}h^2 + \lambda h^4 + \frac{1}{\Lambda^2}h^6 + \dots$$

- 1st order EW phase transition means there is new physics close to the weak scale.
- Can be difficult to discover at the LHC.
- Will leave more signature in Higgs coupling.

For example

$$m^2 h^\dagger h + \tilde{\lambda} (h^\dagger h)^2 + m_S^2 S^2 + \tilde{a} S h^\dagger h + \tilde{b} S^3 + \tilde{\kappa} S^2 h^\dagger h + \tilde{h} S^4$$

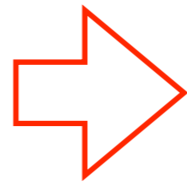
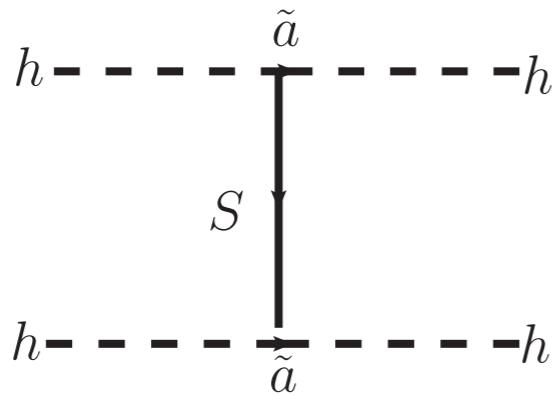

$$\frac{c}{m_S^2} (h^\dagger \partial h)^2$$

shift in h-Z coupling

$$\delta_{Zh} \sim c \frac{v^2}{m_S^2}$$

For example

$$m^2 h^\dagger h + \tilde{\lambda} (h^\dagger h)^2 + m_S^2 S^2 + \tilde{a} S h^\dagger h + \tilde{b} S^3 + \tilde{\kappa} S^2 h^\dagger h + \tilde{h} S^4$$

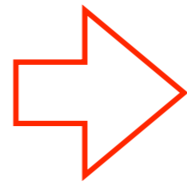
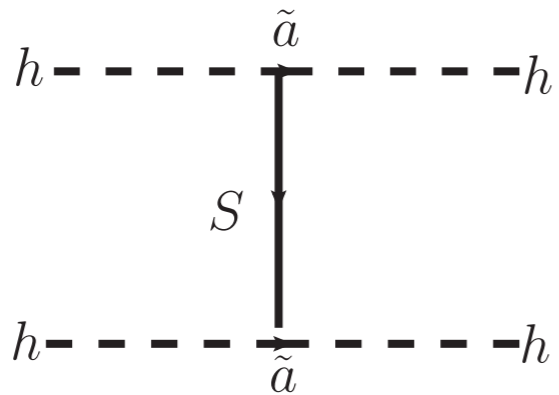

$$\frac{c}{m_S^2} (h^\dagger \partial h)^2$$

shift in h-Z coupling

$$\delta_{Zh} \sim c \frac{v^2}{m_S^2}$$

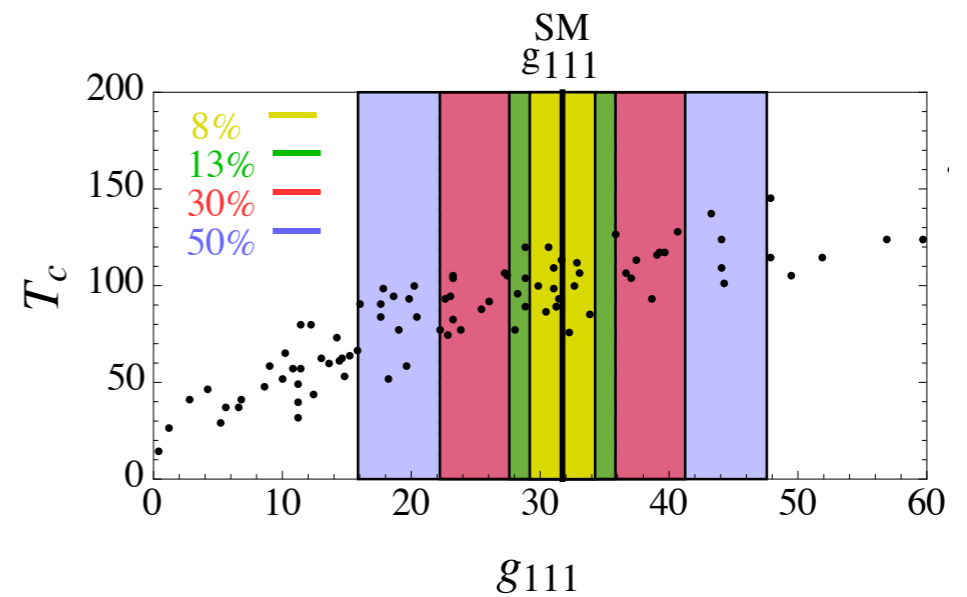
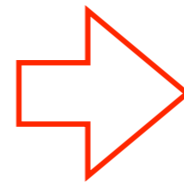
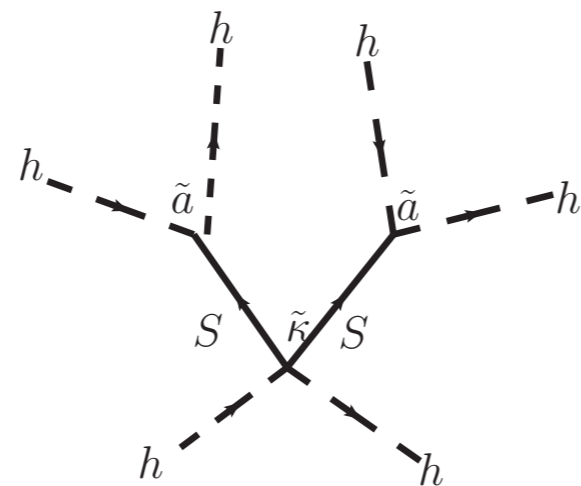
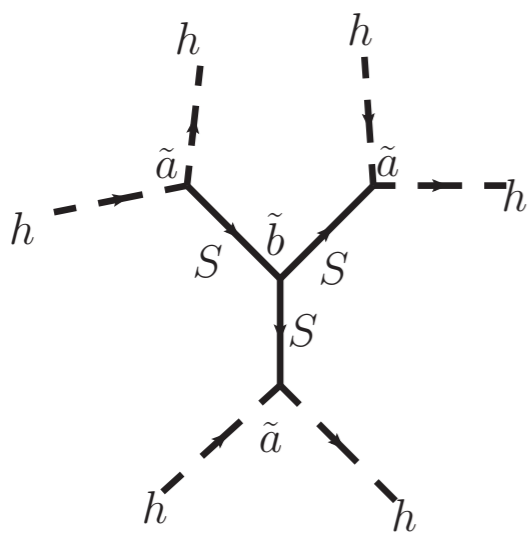

triple Higgs coupling

Probing EWSB at higgs factories

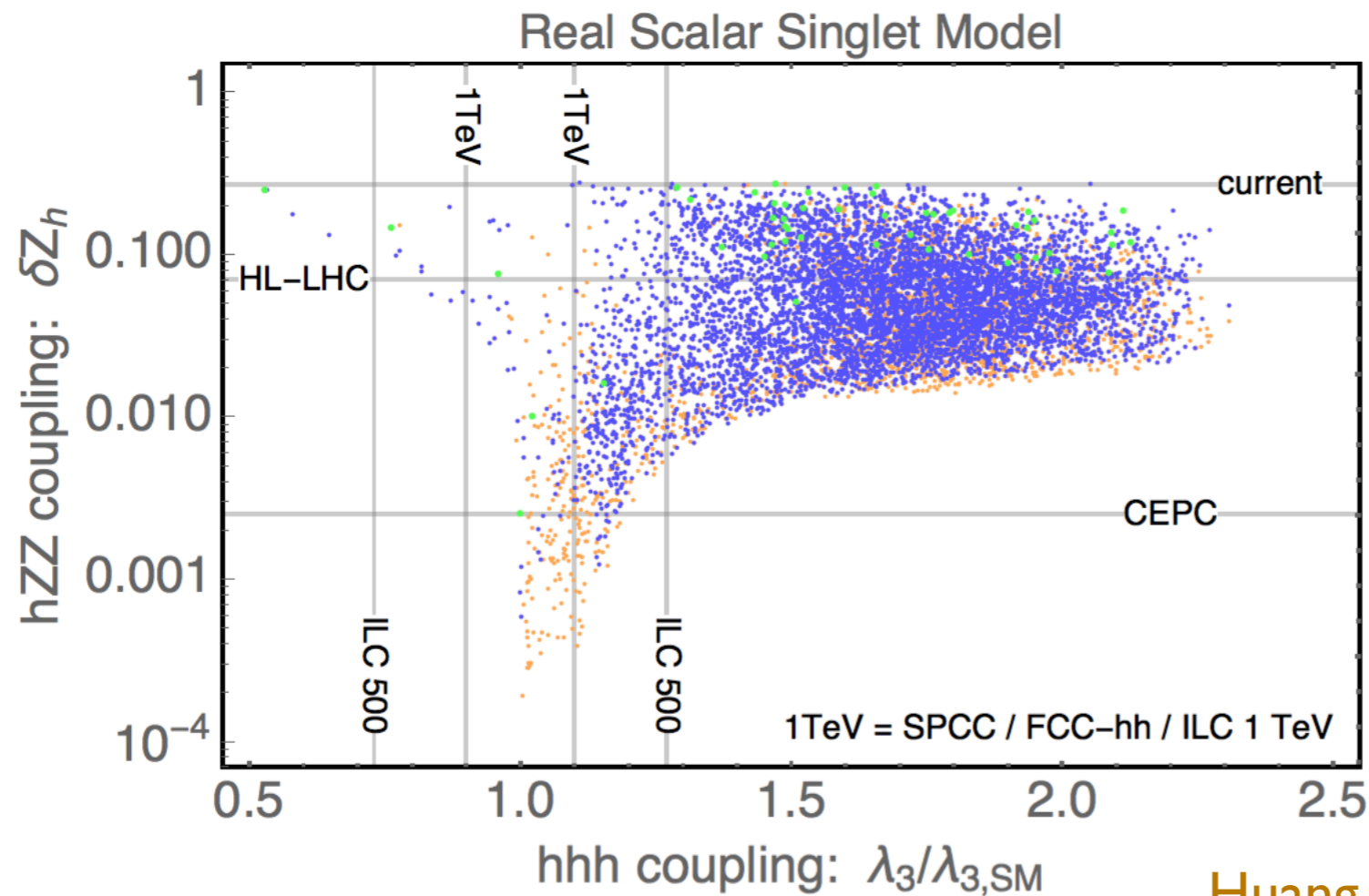

Huang, Long, LTW, 1608.06619

Orange = first order phase transition, $v(T_c)/T_c > 0$
Blue = “strongly” first order phase transition, $v(T_c)/T_c > 1.3$
Green = very strongly 1PT, could detect GWs at eLISA

Good coverage in model space

Nightmare scenario:

Meade et al

Singlet model with a Z_2 $S \rightarrow -S$

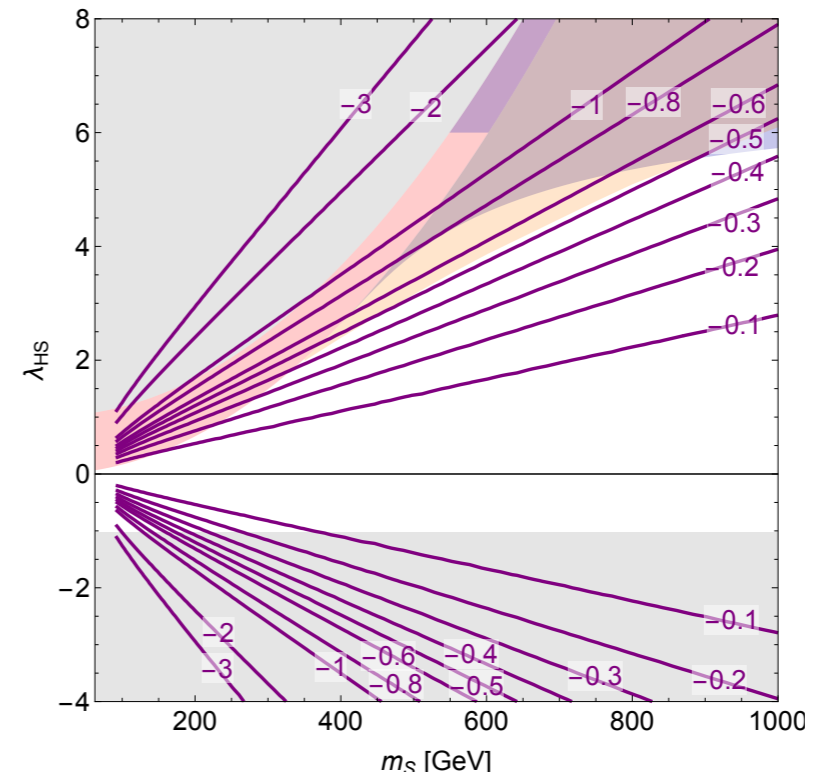
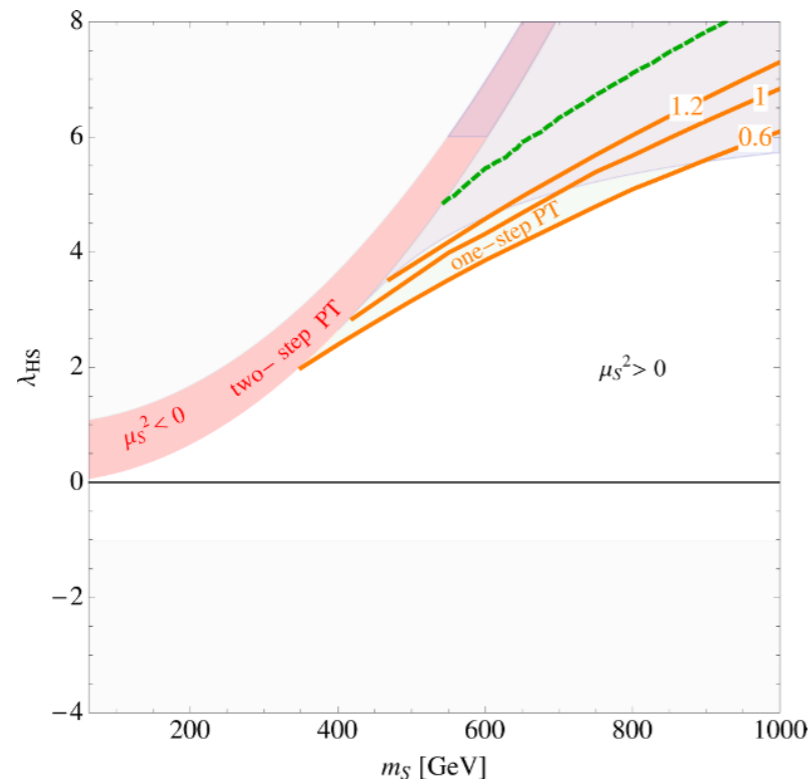

h^6 term generated at 1-loop order

Only marginally visible.

Conclusion

- LHC still has a lot to say.
 - ▶ 15+ years of operation, 95+% of data to come.
 - ▶ Need to think about how to new searches with this data.
- Beyond the LHC, we need future colliders to address the open questions of the Standard Model.

extra

Late comers will be spotted easily:

	L_{T_2}	L_{T_1}	Trigger	ϵ_{trig}	ϵ_{sig}	ϵ_{fake}^j	Ref.
EC	1.17 m	0.2 m	DelayJet	0.5	0.5	10^{-3}	[12]
MS	10.6 m	4.2 m	MS RoI	0.25, 0.5	0.25	5×10^{-9}	[24]

CMS timing module
 ATLAS MS LLP search
 (without timing)

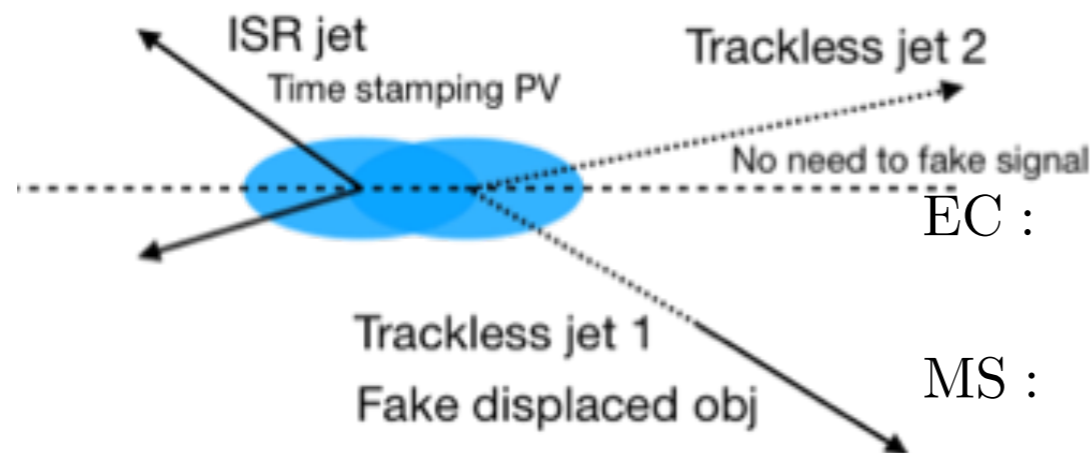

Pile-Up background, time spread
 190 ps (beam property)

$$\text{EC : } N_{\text{bkg}}^{\text{PU}} = \sigma_j \mathcal{L}_{\text{int}} \epsilon_{\text{trig}}^{\text{EC}} \left(\bar{n}_{\text{PU}} \frac{\sigma_j}{\sigma_{\text{inc}}} \epsilon_{\text{fake}}^{j,\text{EC}} f_{\text{nt}}^j \right) \approx 2 \times 10^7,$$

$$\text{MS : } N_{\text{bkg}}^{\text{PU}} = \sigma_j \mathcal{L}_{\text{int}} \epsilon_{\text{trig}}^{\text{MS}} \left(\bar{n}_{\text{PU}} \frac{\sigma_j}{\sigma_{\text{inc}}} \epsilon_{\text{fake}}^{j,\text{MS}} f_{\text{nt}}^j \right) \approx 50, \quad (5)$$

Pile-up BKG: intrinsic resolution

~190 ps

EC (30ps) cut: $\Delta t > 1$ ns

BKG(EC-PU) ~ 1.3

MS (30ps) cut: $\Delta t > 0.4$ ns

BKG(MS-PU) ~ 0.86

The detector time resolution for MS can be downgraded to hundreds of ps

MS (200ps) cut: $\Delta t > 1$ ns

BKG(MS-PU) $\ll 1$

Late comers will be spotted easily:

	L_{T_2}	L_{T_1}	Trigger	ϵ_{trig}	ϵ_{sig}	ϵ_{fake}^j	Ref.
EC	1.17 m	0.2 m	DelayJet	0.5	0.5	10^{-3}	[12]
MS	10.6 m	4.2 m	MS RoI	0.25, 0.5	0.25	5×10^{-9}	[24]

CMS timing module
 ATLAS MS LLP search
 (without timing)

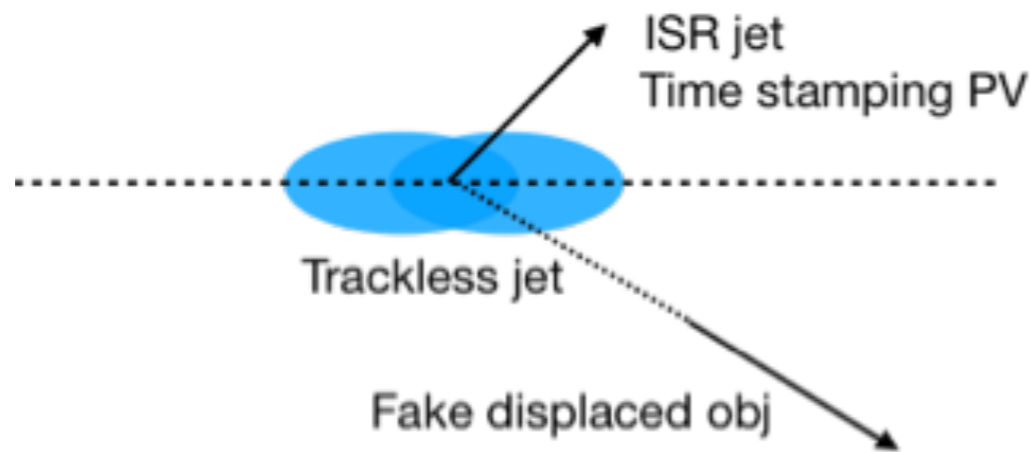

Same-vertex hard scattering
 background, time spread 30 ps
 (precision timing)

$$\text{EC : } N_{\text{bkg}}^{\text{SV}} = \sigma_j \mathcal{L}_{\text{int}} \epsilon_{\text{trig}}^{\text{EC}} \epsilon_{\text{fake}}^{j,\text{EC}} \approx 1 \times 10^{11}$$

$$\text{MS : } N_{\text{bkg}}^{\text{SV}} = \sigma_j \mathcal{L}_{\text{int}} \epsilon_{\text{trig}}^{\text{MS}} \epsilon_{\text{fake}}^{j,\text{MS}} \approx 4 \times 10^5,$$

Hard collision BKG: detector time
 resolution ~ 30 ps
 EC (30ps) cut: $\Delta t > 0.4$ ns
 MS (30ps) cut: $\Delta t > 1$ ns
 BKG(SV) $\ll 1$

The detector time resolution for MS
 can be downgraded to hundreds of ps
 MS (200ps) cut:
 $\Delta t > 1$ ns
 BKG(MS-SV) ~ 0.11

Probing EW phase transition

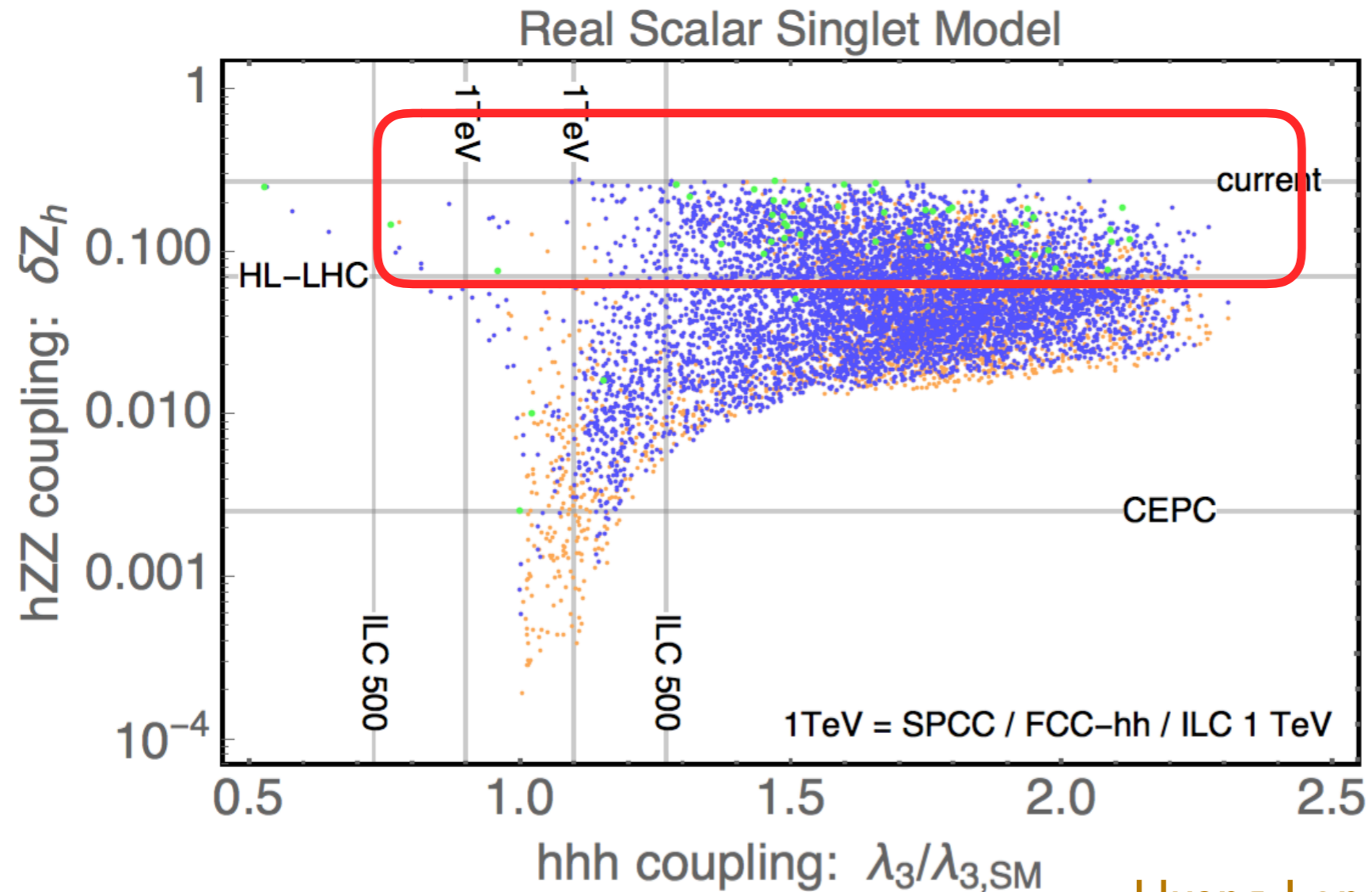

Huang, Long, LTW, 1608.06619

Orange = first order phase transition, $v(T_c)/T_c > 0$
Blue = “strongly” first order phase transition, $v(T_c)/T_c > 1.3$
Green = very strongly 1PT, could detect GWs at eLISA

Search based on EC

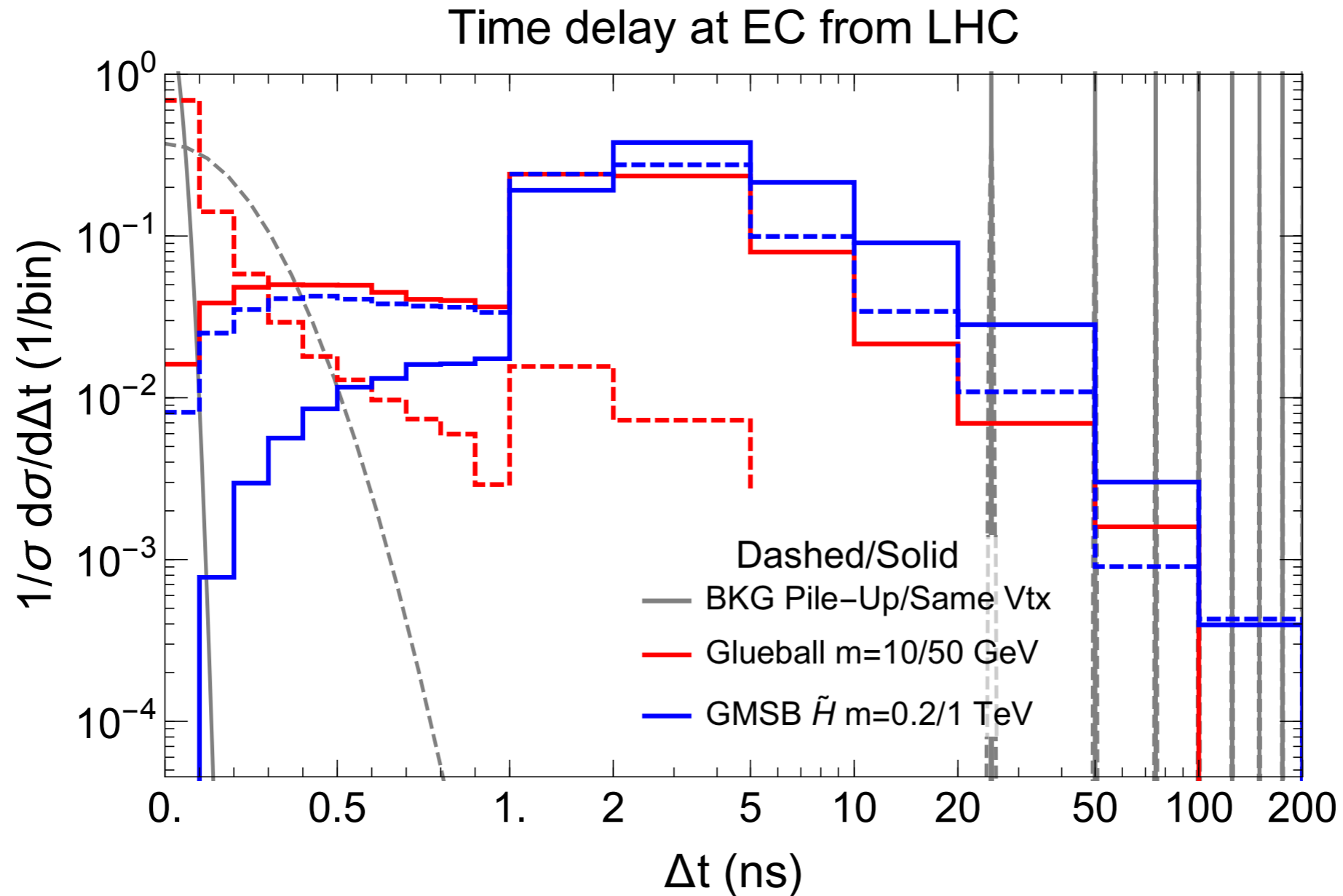

After timing cut: $\Delta t > 0.8$ ns

Back ground dominated by pile up

$\#_{\text{background}} \sim 1$

Search based on MS

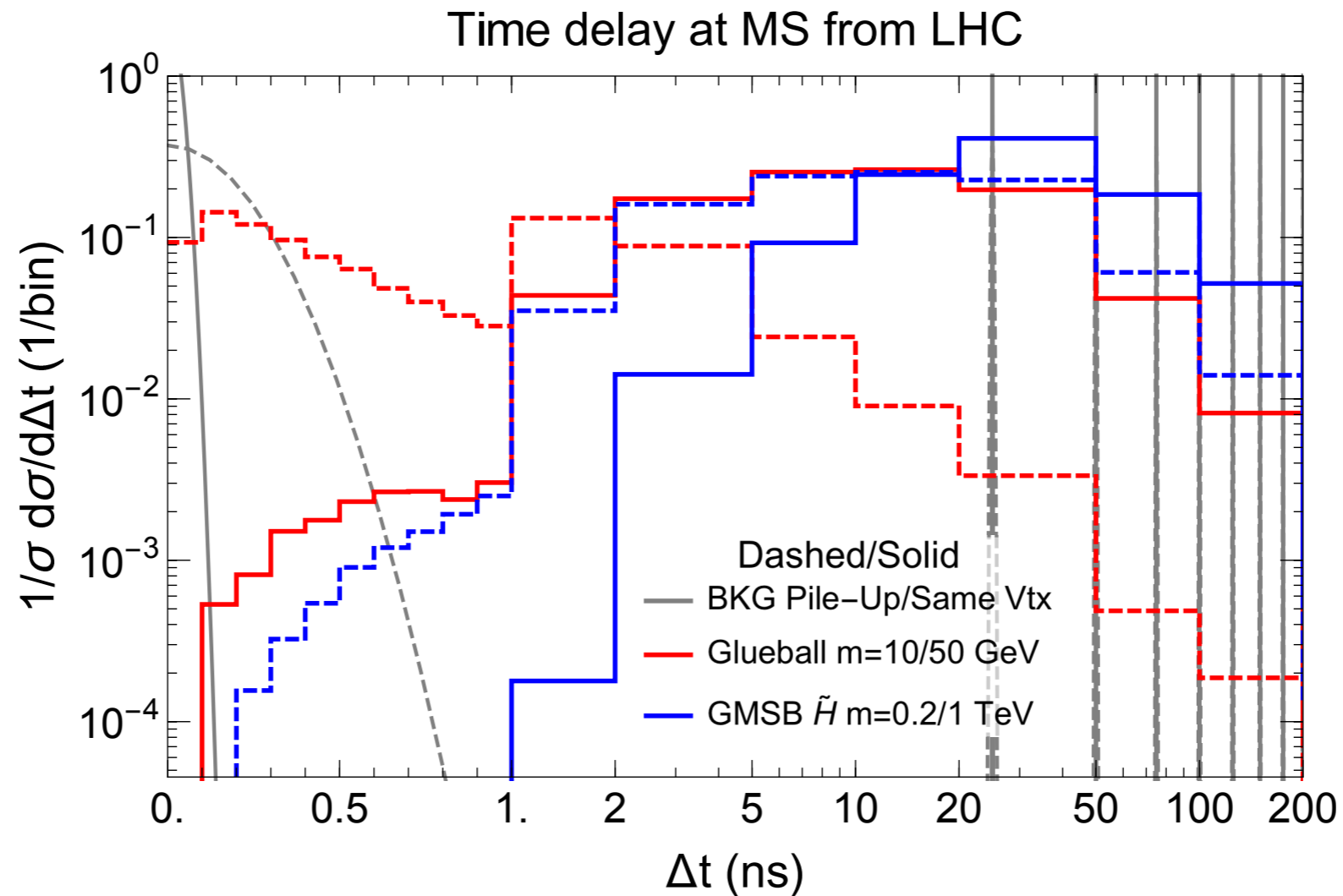

Pile up background smaller, shielded by HCAL etc.

Before timing cut: ~ 50

After timing cut: $\Delta t > 0.4$ ns $\#_{\text{background}} \sim 1$

Further away, larger Δt for signal.

Search based on MS

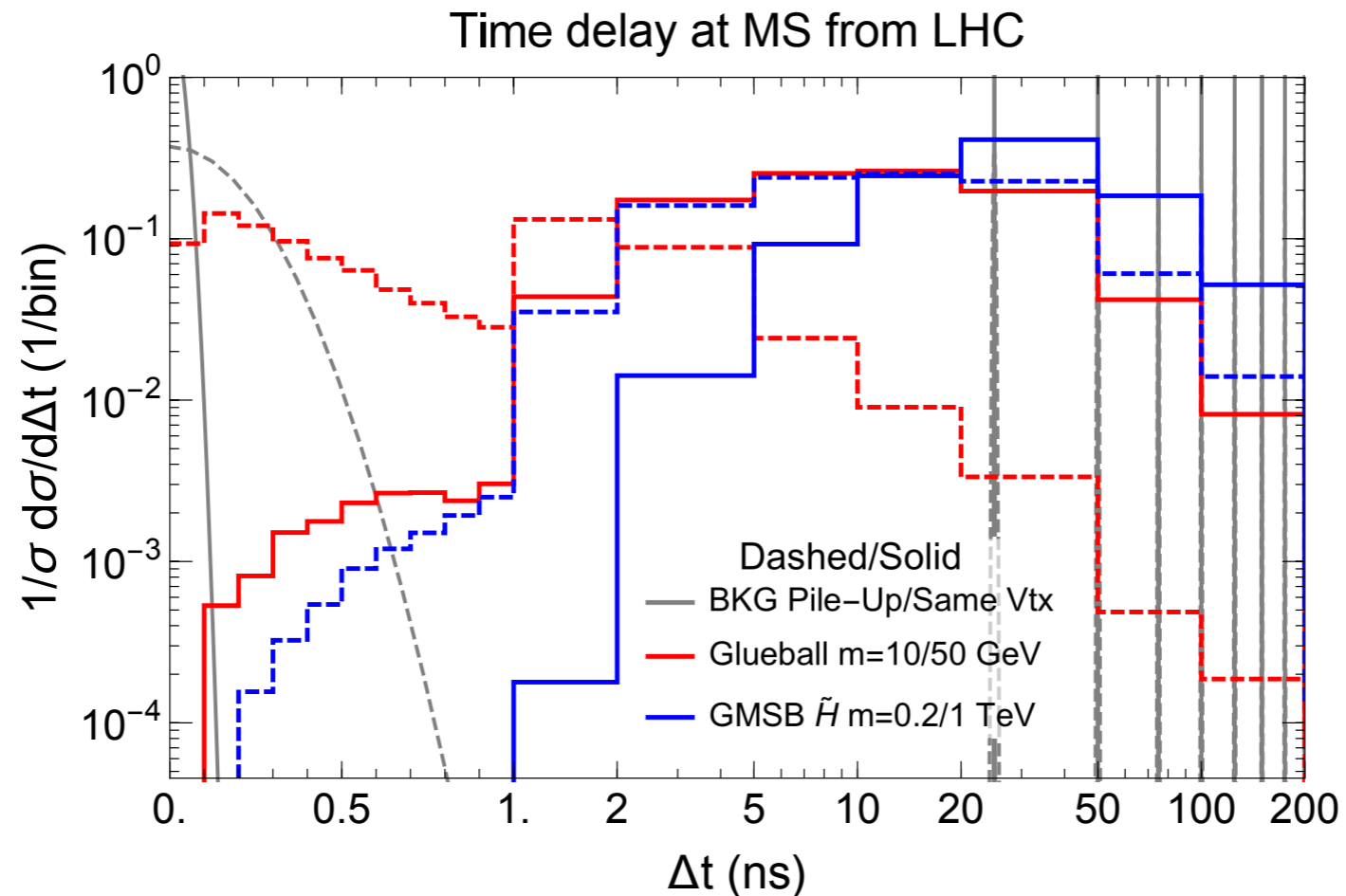

Pile up background smaller, shielded by
HCAL etc.

$$\Delta t > 0.4 \text{ ns} \quad \#_{\text{background}} \sim 1$$

Further away, larger Δt for signal.

no need for super
good timing resolution

$$\delta t \sim 200 \text{ ps}$$

will do

Signal

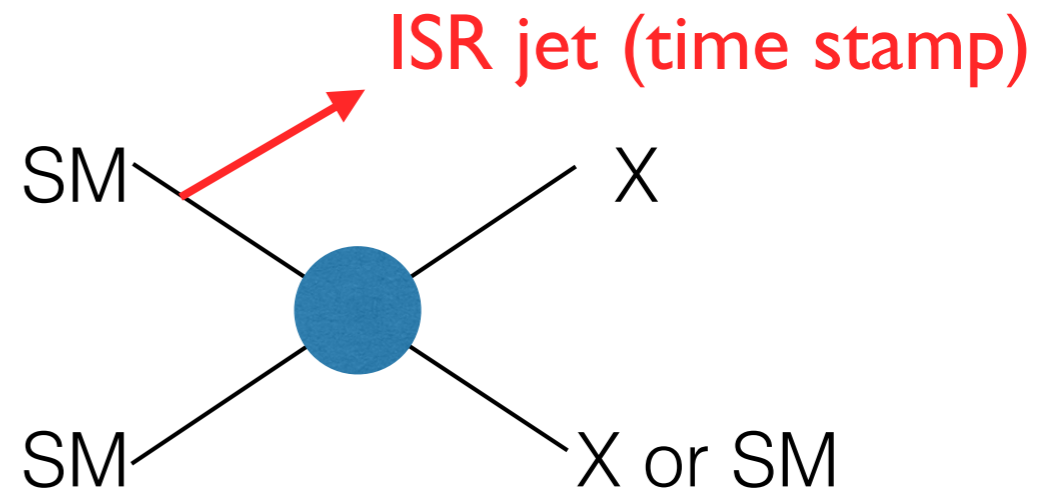
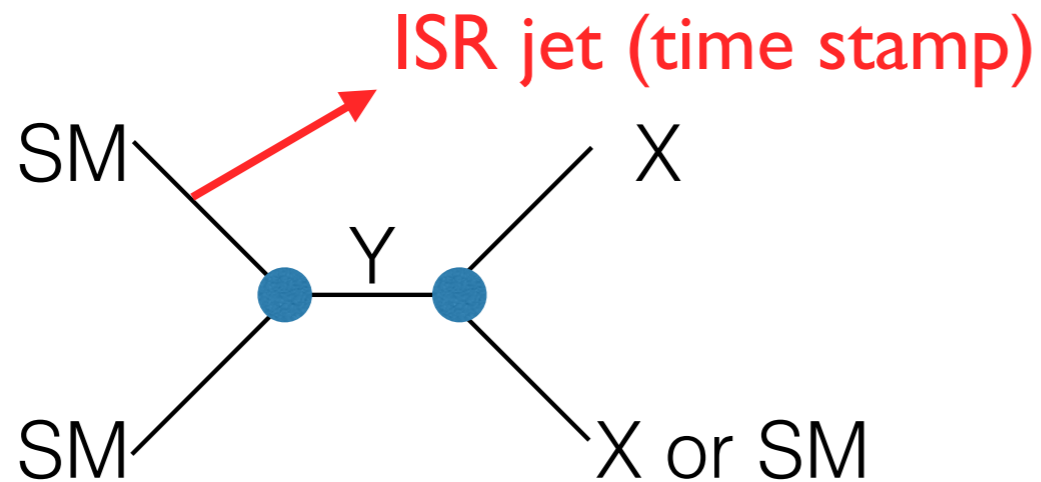

1. ISR jet provides the time for the hard collision
2. LLP decay before reaching timing layer.

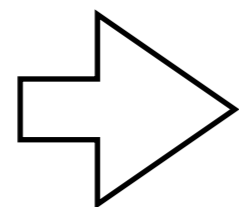

measurement of Δt

background

Same hard interaction

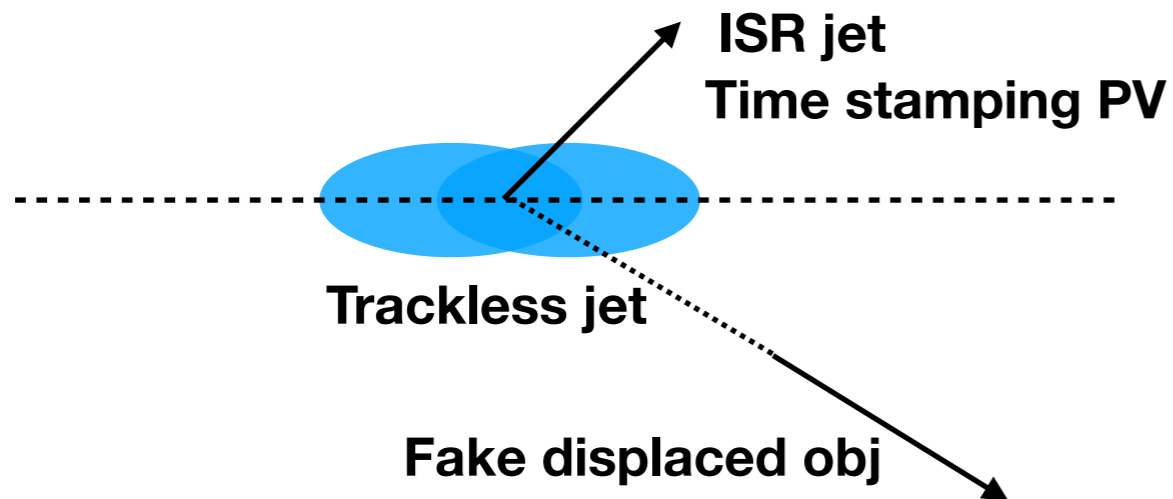

Time delay from
resolution of timing detector.

Pile up

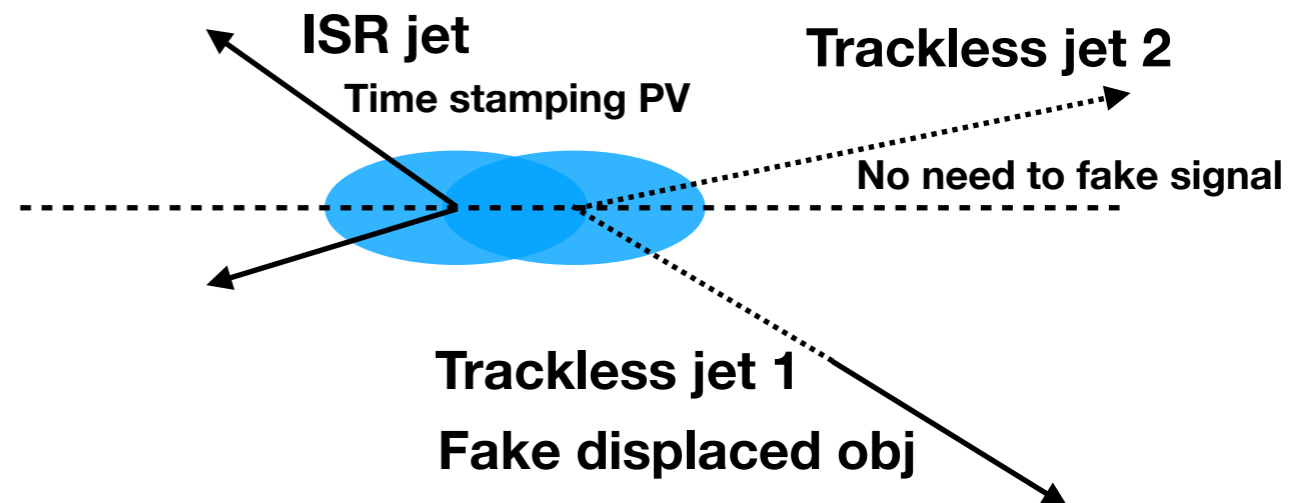

Time delay from
spread of the proton bunch
 ~ 190 ps

Importance of precision measurement

- No clear indication where new physics might be.
 - ▶ Precision measurement can give crucial guidance.
- Lots of data still to come
 - ▶ Room to improve! Statistics and systematics.
- Will be an important part of the legacy of the LHC.
 - ▶ LEP taught us a lot. LHC will do the same.

Summary of LLP searches

- Timing information can significantly improve the reach.
- The result shown are based on generic cuts (ISR+ any delayed decay).
 - ▶ Broadly applicable.
 - ▶ Further optimization possible for specific decay channel.
- Designing effective triggering strategy is crucial next step.

Precision measurement at the LHC possible?

At LHC, interference with SM crucial

Signal-SM interference

$$\frac{\delta\sigma}{\sigma_{\text{SM}}} \sim \frac{E^2}{\Lambda^2} \sim 0.25$$

Without interference

$$\frac{\delta\sigma}{\sigma_{\text{SM}}} \sim \frac{E^4}{\Lambda^4} \sim 0.05$$

1. WZ final states, only longitudinal mode useful
2. W/Z+h

Will be challenging

SM WW, WZ processes are dominated by transverse modes

$$\sigma_{SM}^{total} / \sigma_{SM}^{LL} \sim 15 - 50$$

New technique such as polarization tagging of W/Z crucial

Wh/Zh(bb) channels have large reducible background

$$\text{LHC @ 8 TeV : } \sigma_b^{red} / \sigma_{SM}^{Wh} \sim 200 - 10$$

Difficult measurement. Large improvement needed.
Room for developing new techniques

Time delay

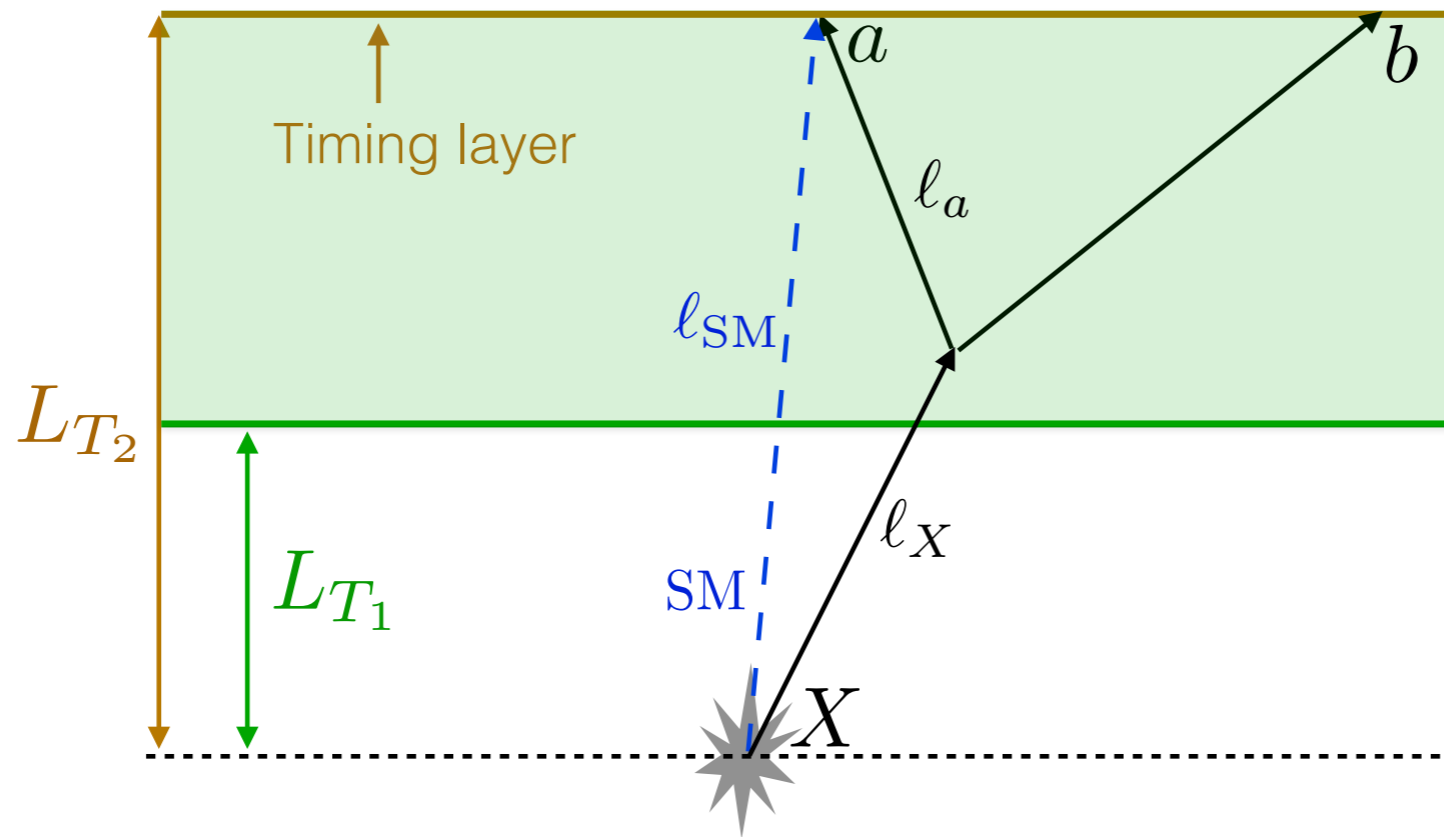

- **timing layers considered here:**

- **CMS EC search: $LT_1 = 0.2$ m, $LT_2 = 1.2$ m (EC = Electromagnetic Calorimeter)**

- **Resolution: $\delta t = 30$ ps**

- **MS search (hypothetical): $LT_1 = 4.2$ m, $LT_2 = 10.6$ m (MS = Muon Spectrometer)**

- **Resolution: don't need to be as good (detail later)**

Higgs coupling vs direct search

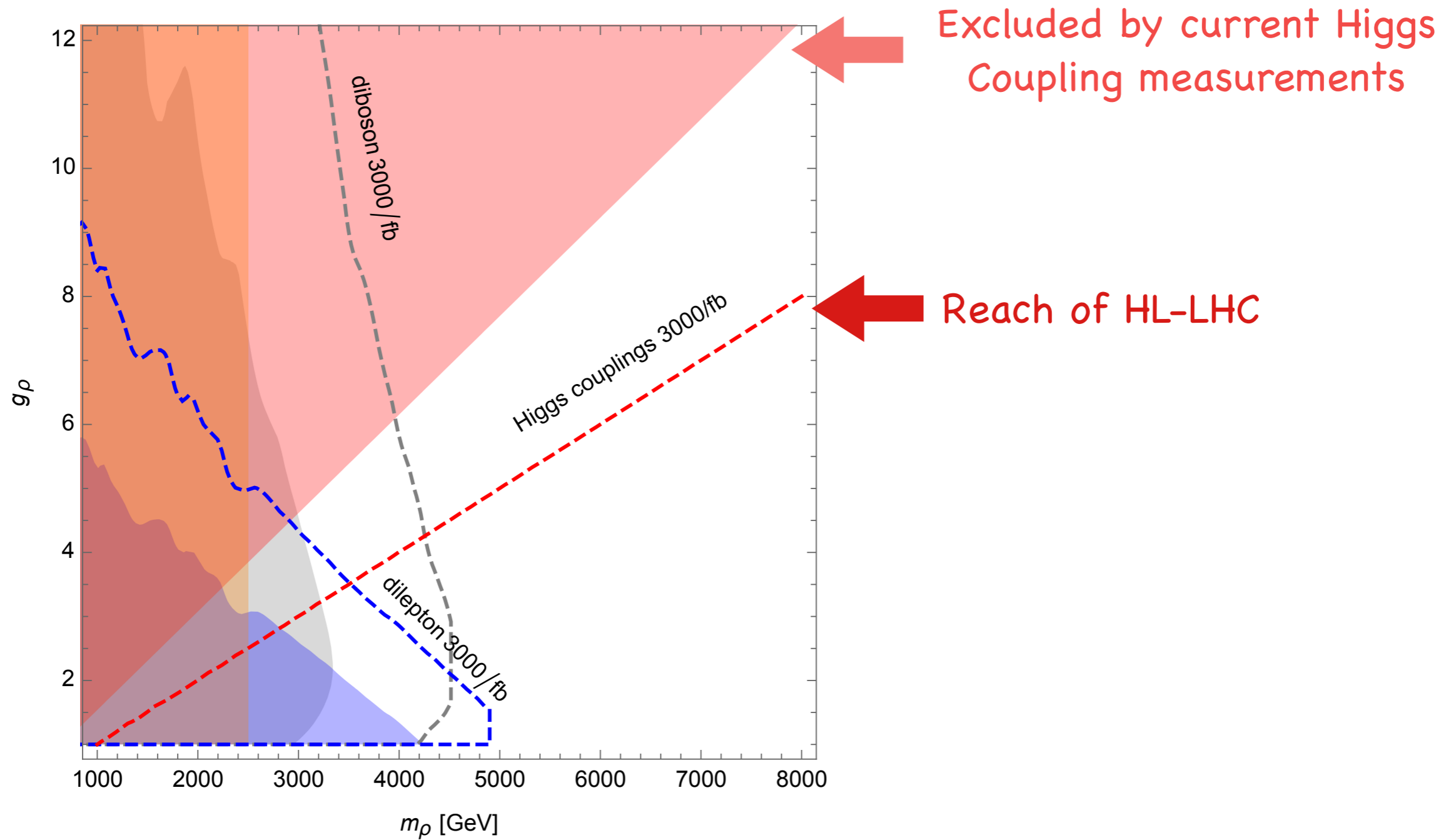

Testing naturalness at 100 TeV pp collider

Cohen et. al., 2014

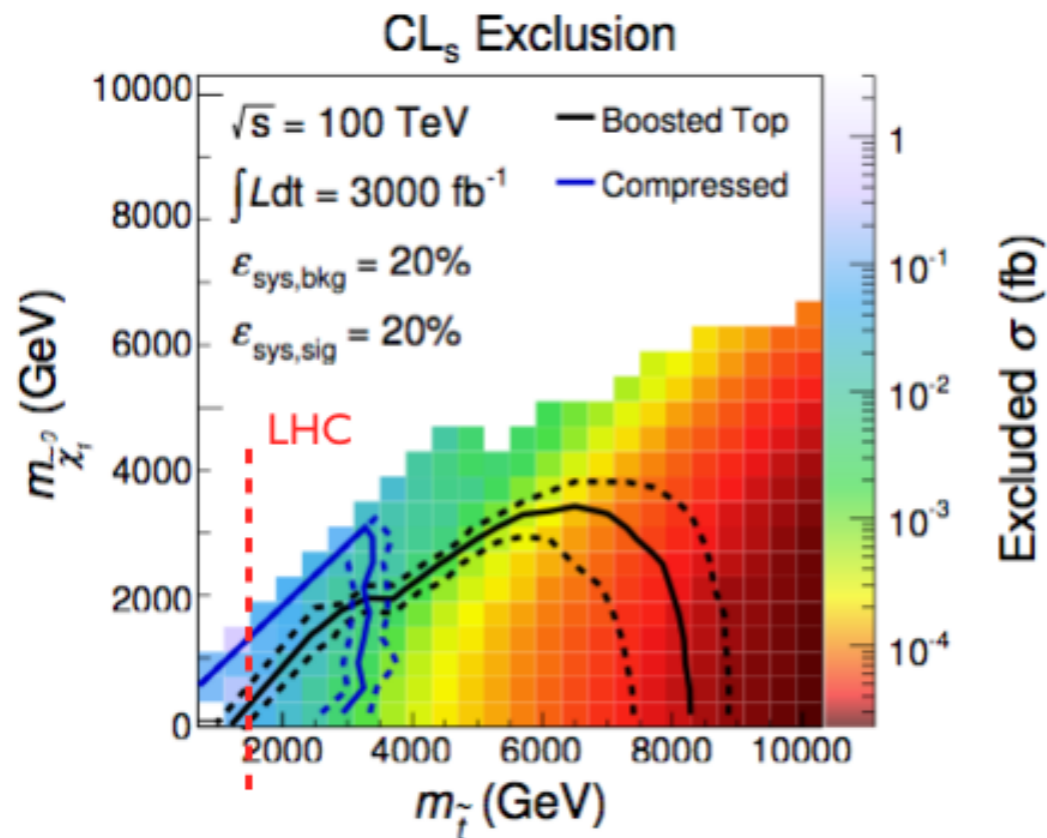

Pappadopulo, Thamm, Torre, Wulzer, 2014

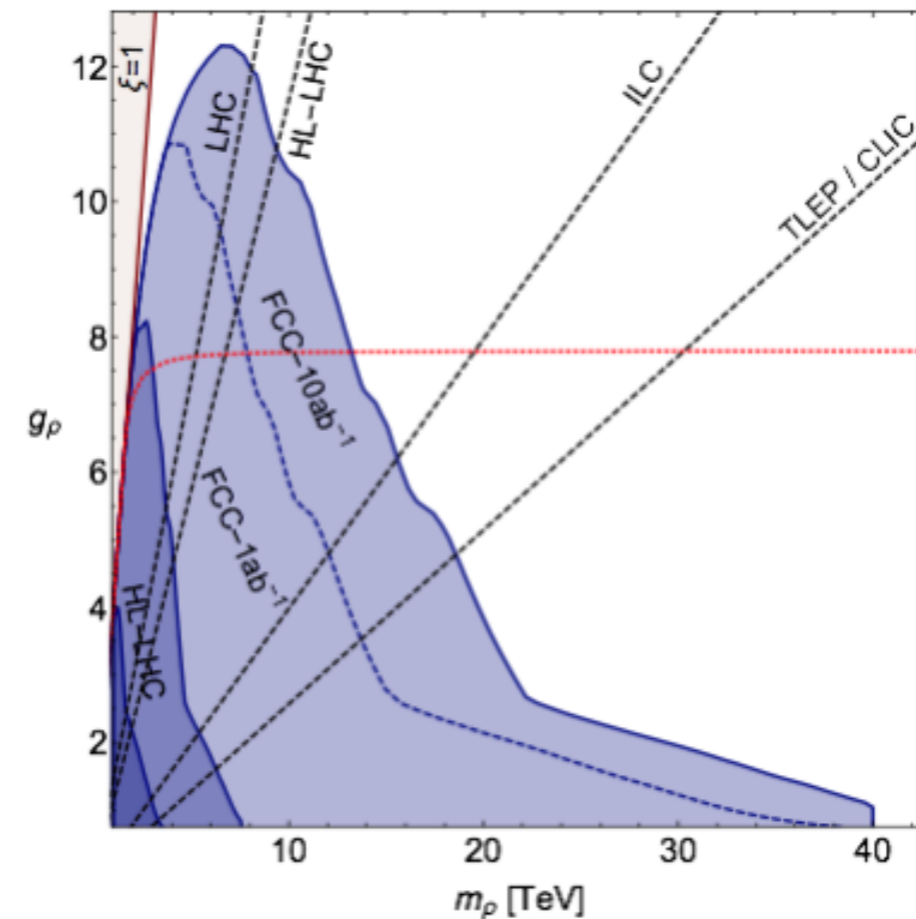

Fine tuning: $(M_{\text{NP}})^{-2}$