



清華大學

Tsinghua University



*Baryon Stopping, Charged and Strange
Particle Distributions
in Al+Au Collisions at $\sqrt{s_{NN}} = 4.9$ GeV*

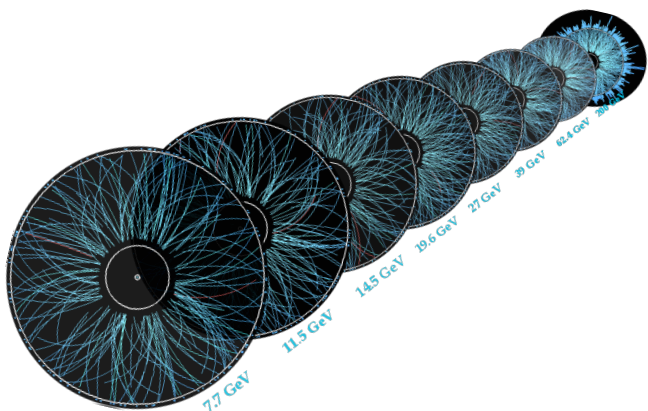

Muhammad Usman Ashraf

(for the STAR collaboration)

Tsinghua University Beijing

The 7th Asian Triangle Heavy-Ion Conference (ATHIC 2018)

November 3-6, 2018, University of Science and Technology of China, Hefei, Anhui, China



- ✓ *BES-I and STAR Fixed-Target Program*
- ✓ *Overview of the STAR Detector*
- ✓ *STAR Fixed-Target Geometry*
- ✓ *π^- , Proton, K_S^0 and Λ Production from Al+Au Collisions at $\sqrt{s_{NN}} = 4.9$ GeV*
 - ✓ *Transverse Mass Spectra*
 - ✓ *dN/dy Distributions and Comparison with E802 Experiment at AGS*
 - ✓ *Meson Discussion*
 - ✓ *Baryon Discussion*
- ✓ *Future Upgrades and Fixed-Target Program*
- ✓ *Summary*

BES-I and STAR Fixed-Target Program



Goals of BES-I

- ✓ Study the onset of de-confinement and phase boundary.
- ✓ Search for the QCD critical point.
- ✓ Turn-off of QGP signals.
- ✓ Find evidence of the possible first-order phase transition.

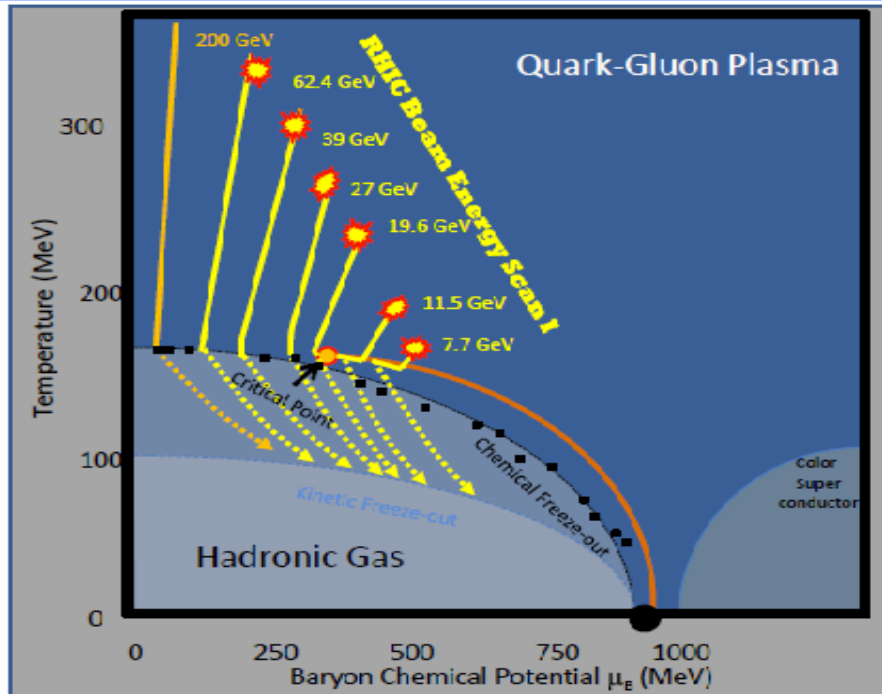

Need to probe lower energies!

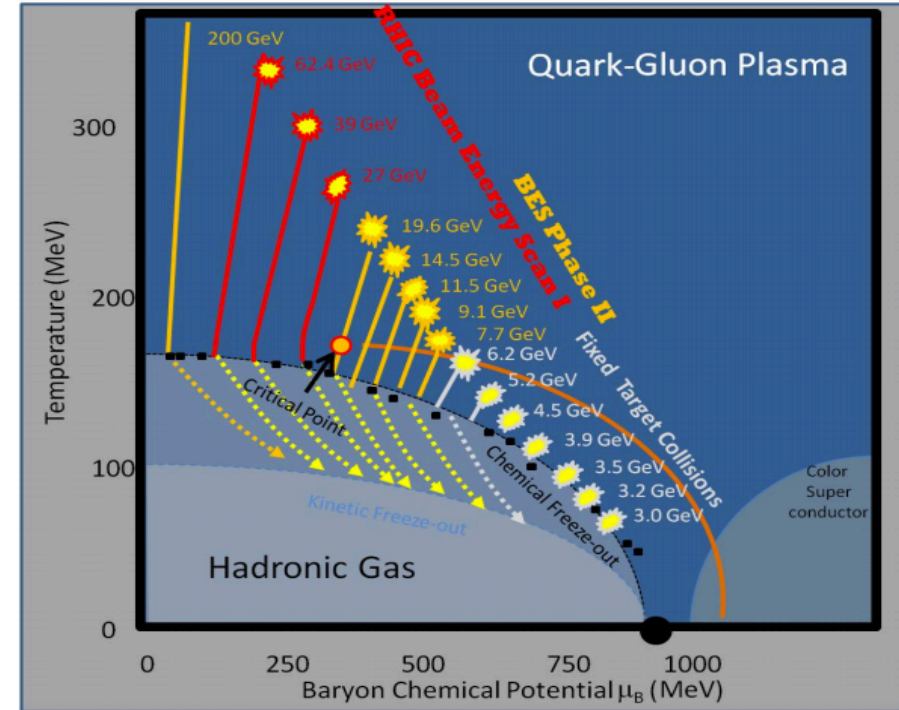

Motivation of the Fixed-Target

- ✓ Provide control measurements for searches of the critical point and onset of deconfinement.
- ✓ Test run focused on demonstrating STAR FXT capabilities.
- ✓ FXT Collisions allow us to extend the μ_B range.

The *Solenoidal Tracker At RHIC (STAR)*



EEMCES MD

Magnet

MTD

BEMC
BSMD

TOF

BBC

FMS
FPS

ZDC

HFT

TPC

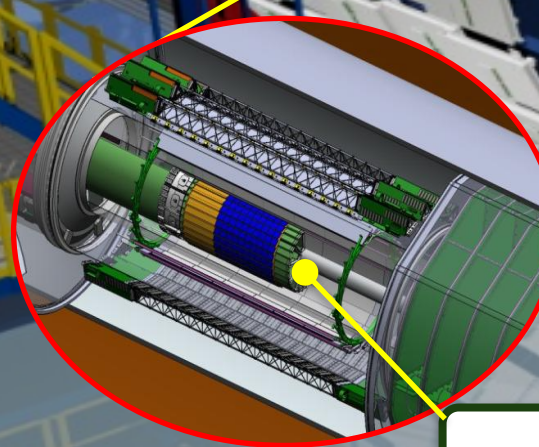

STAR Fixed-Target Geometry

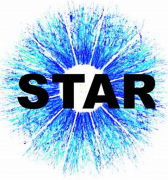

- ✓ The Fixed Target was installed inside the vacuum pipe at $z = 211$ cm
- ✓ Gold foil is 1 mm thick with about a 4% interaction probability
- ✓ 3.4 M Al+Au events with top 30% centrality trigger

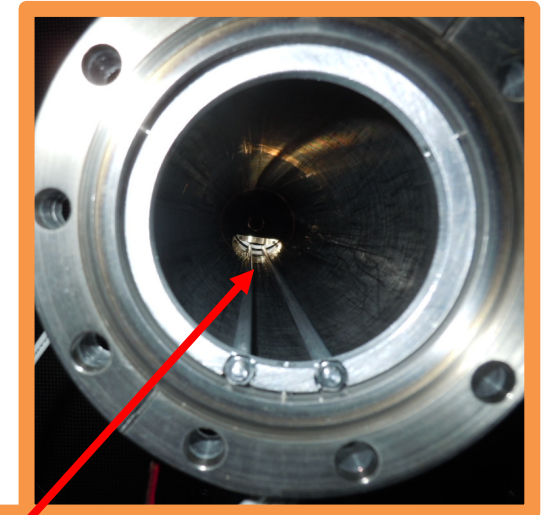
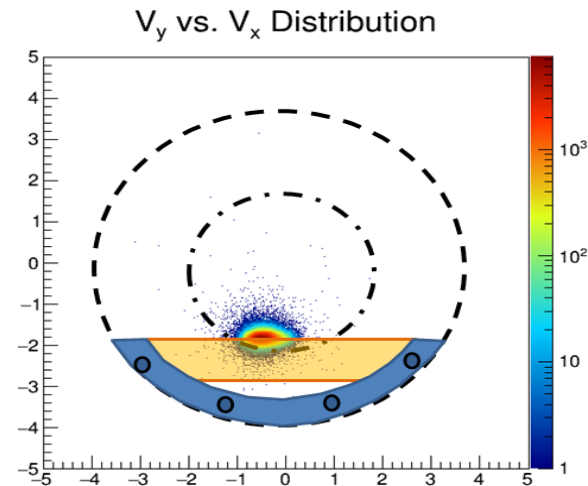
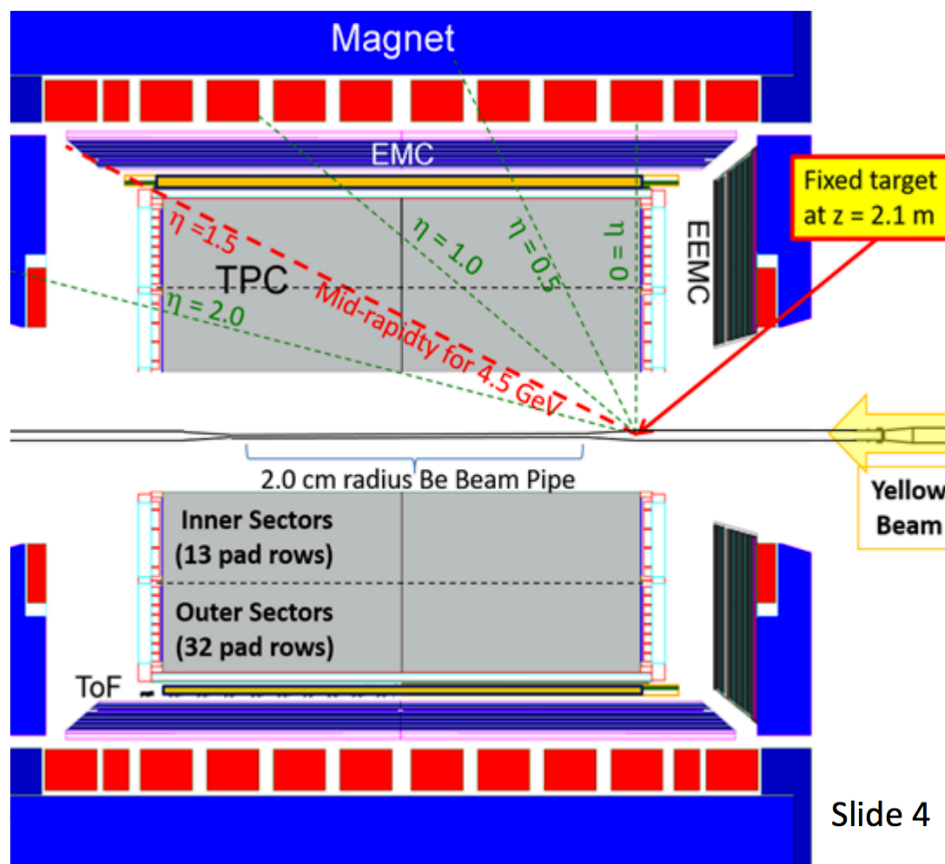

Beam Pipe

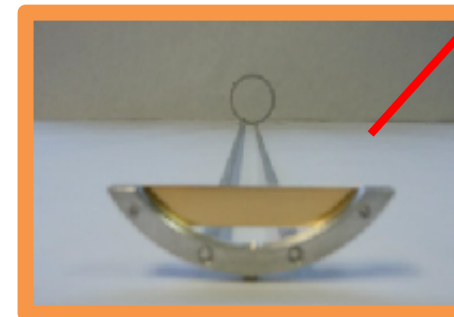

Au-Target

Centrality Determination



- ✓ *The centrality variable is the number of tracks that pass our basic track QA cuts.*
- ✓ *3.4 M Al+Au events collected with the top 30% centrality.*
- ✓ *Events with a multiplicity greater than 125, were excluded from all analyses since this region of multiplicity is dominated by pile-up events.*
- ✓ *It is not a beam pipe study.*

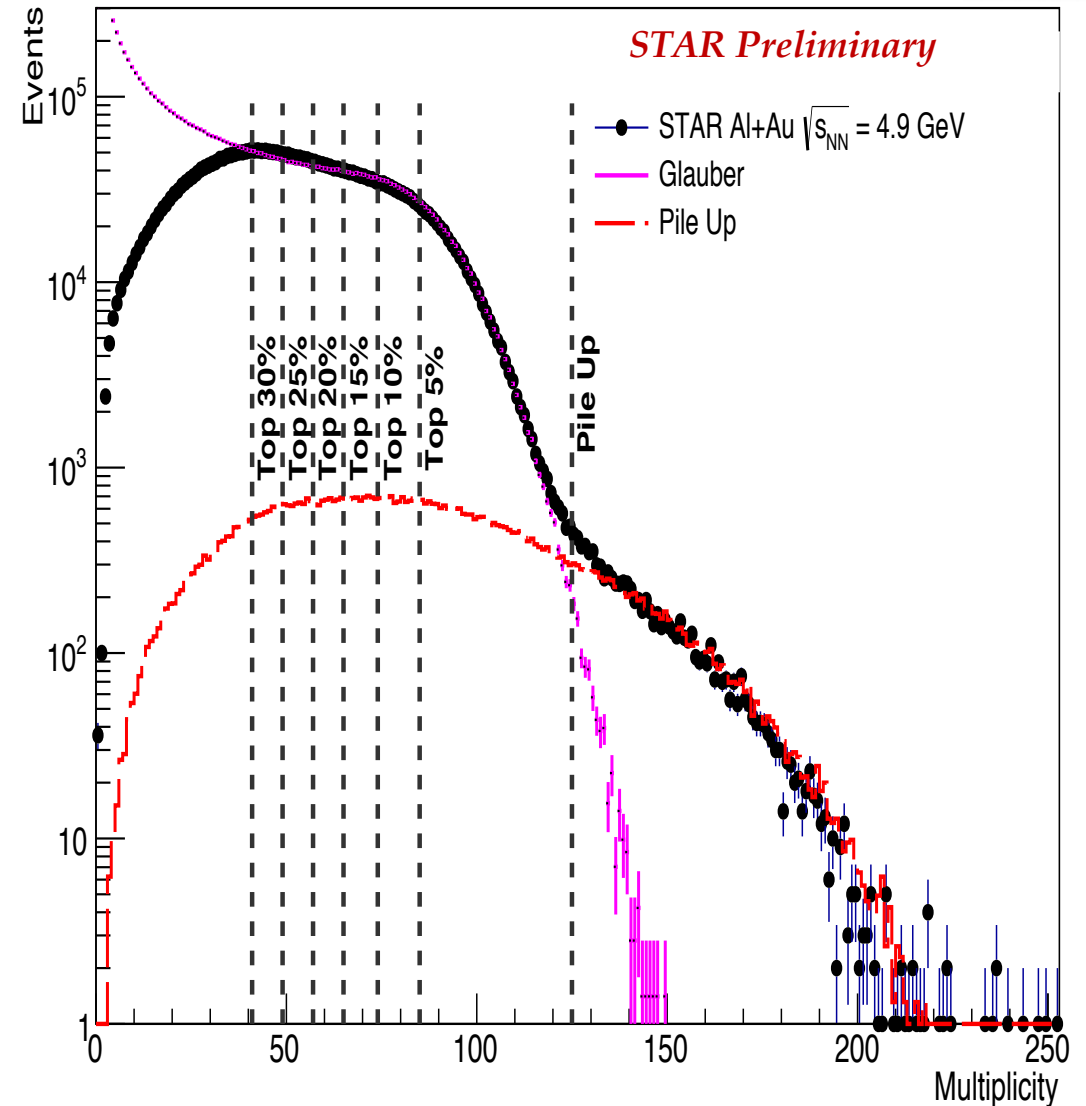

π^- , Proton, K_S^0 and Λ Production

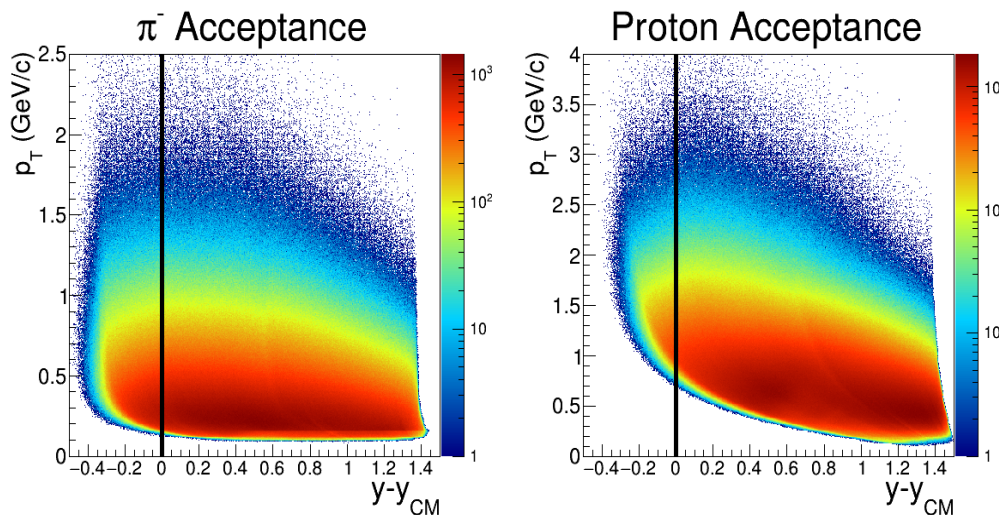

- ✓ Al+Au 4.9 GeV, 0-5%, full p_T range
 - ✓ $K_S^0 \rightarrow \pi^+ + \pi^-$
 - ✓ $\Lambda \rightarrow p + \pi$
- π, K, p are identified with TPC dE/dx
reconstruct the secondary vertex

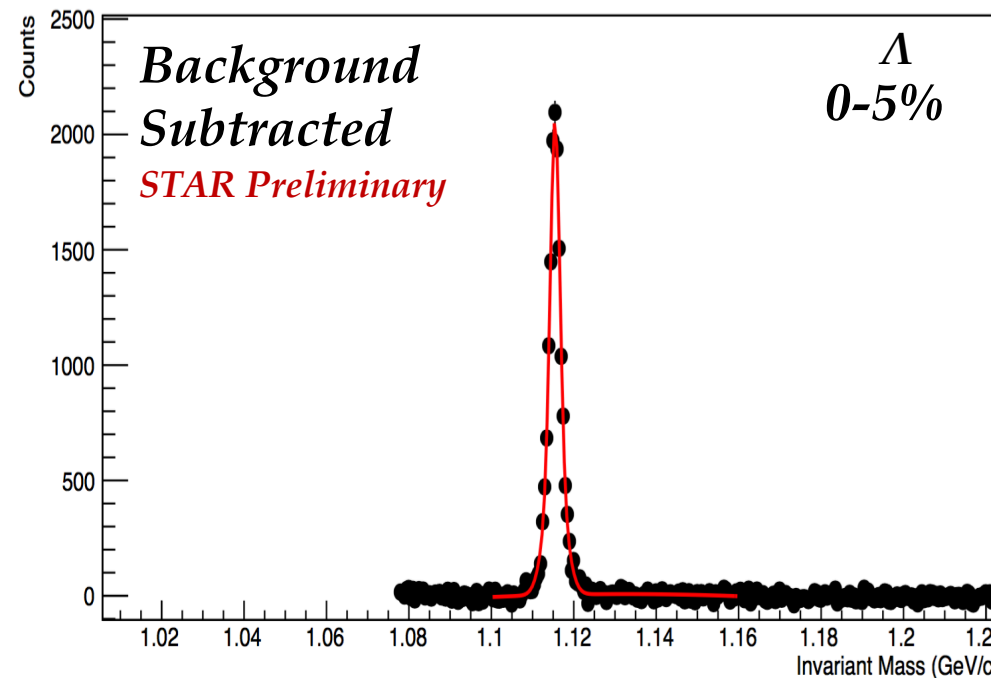
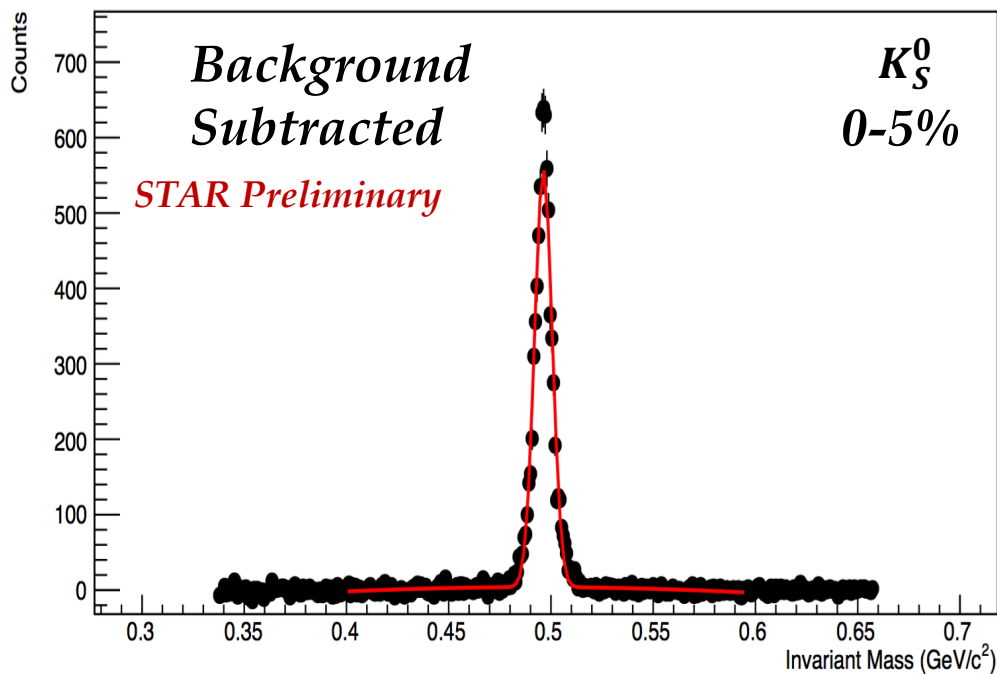

π^- , Proton, K_S^0 and Λ Production

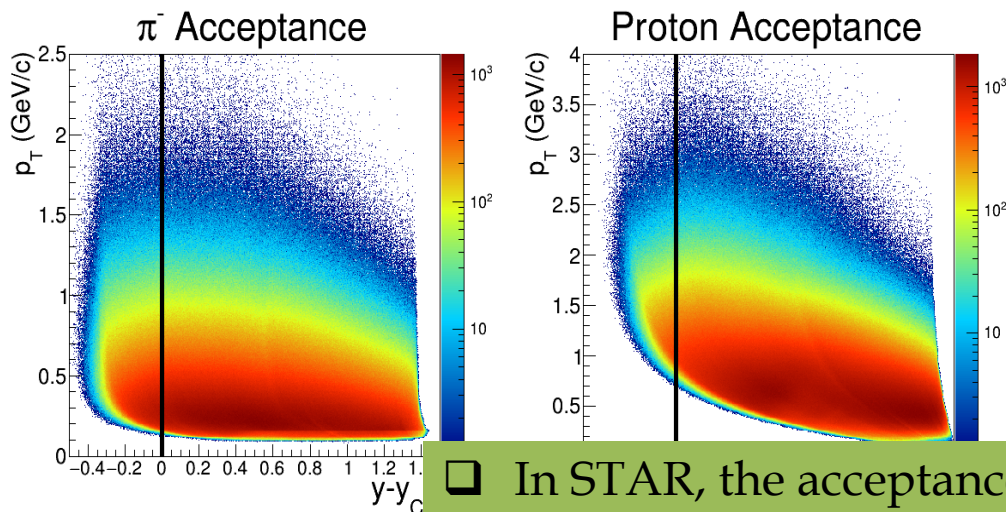

- ✓ Al+Au 4.9 GeV, 0-5%, full p_T range
 - ✓ $K_S^0 \rightarrow \pi^+ + \pi^-$
 - ✓ $\Lambda \rightarrow p + \pi$
- π, K, p are identified with TPC dE/dx
reconstruct the secondary vertex

□ In STAR, the acceptance for particles and anti-particles is the same. This is not normally true for an experiment with a dipole magnet.

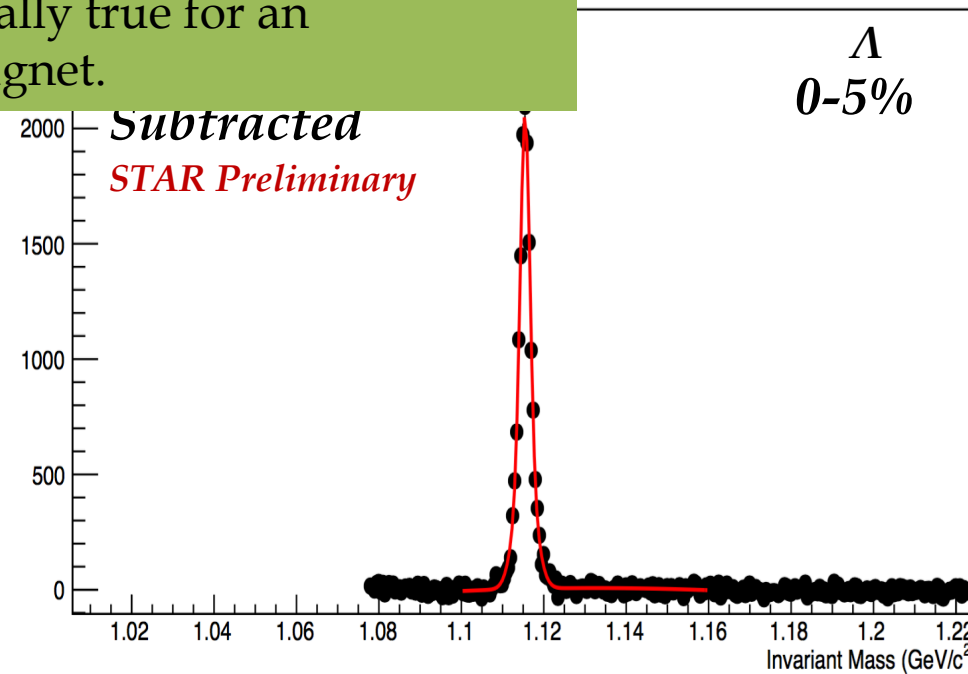
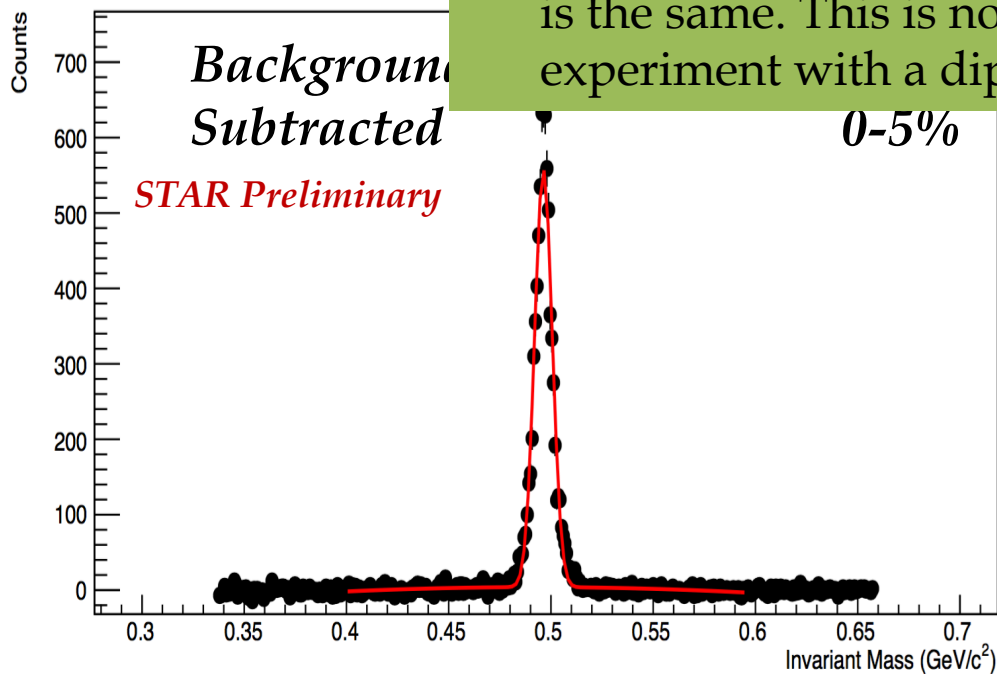

π^- Spectra

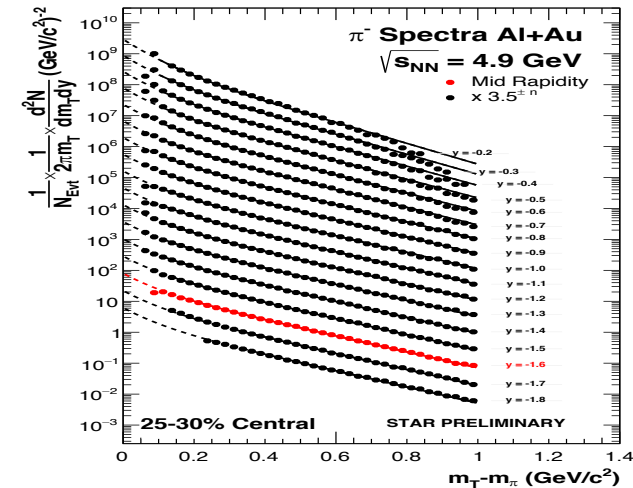
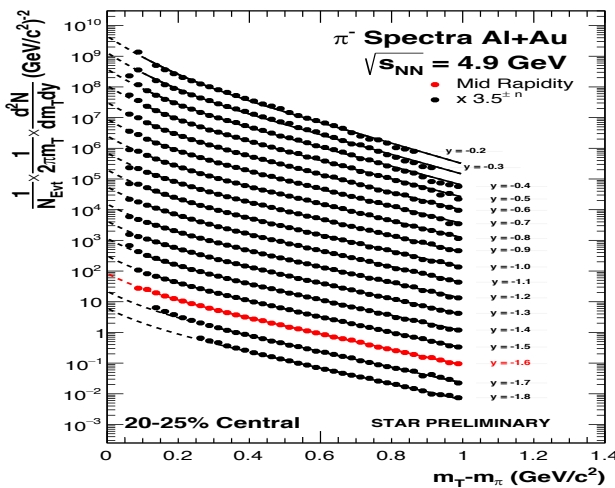
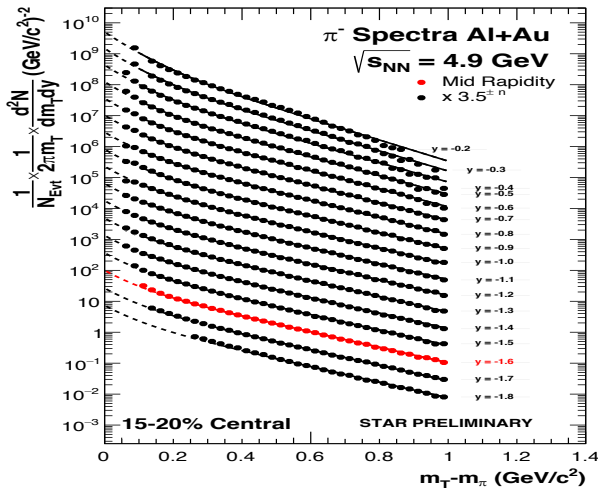
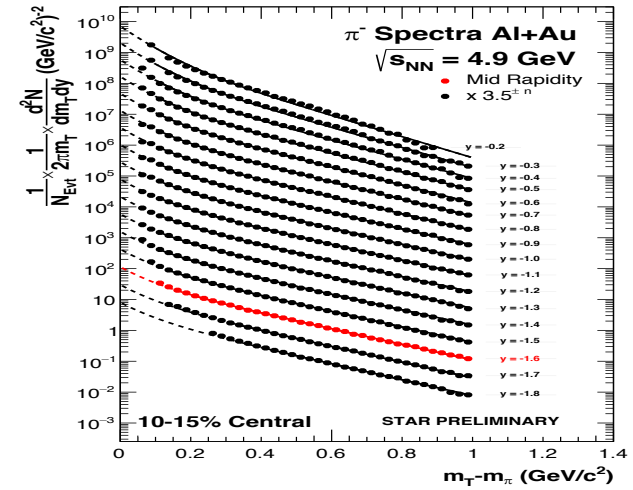
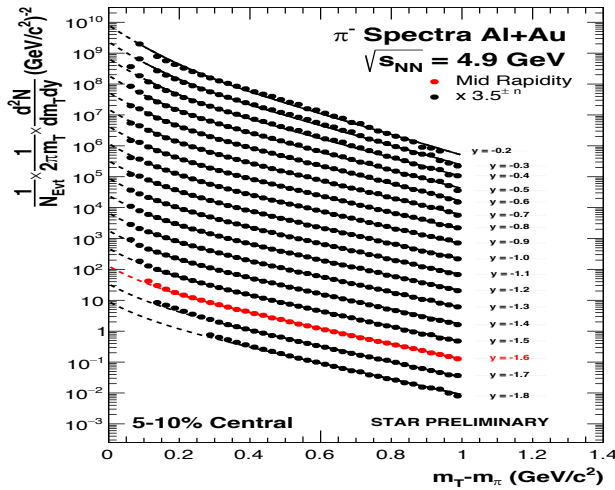
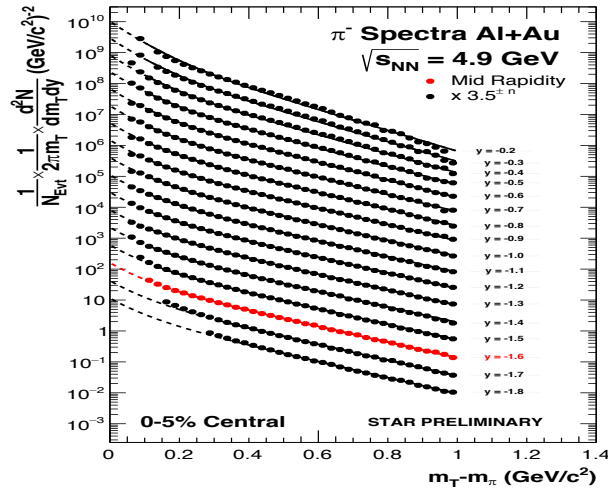

- ✓ π^- spectra for different rapidity ranges and different centralities scaled by the factor of $3^{\pm n}$. $n=0$ for mid rapidity
- ✓ π^- data extrapolated to low and high m_T with the double Bose-Einstein fitting function.

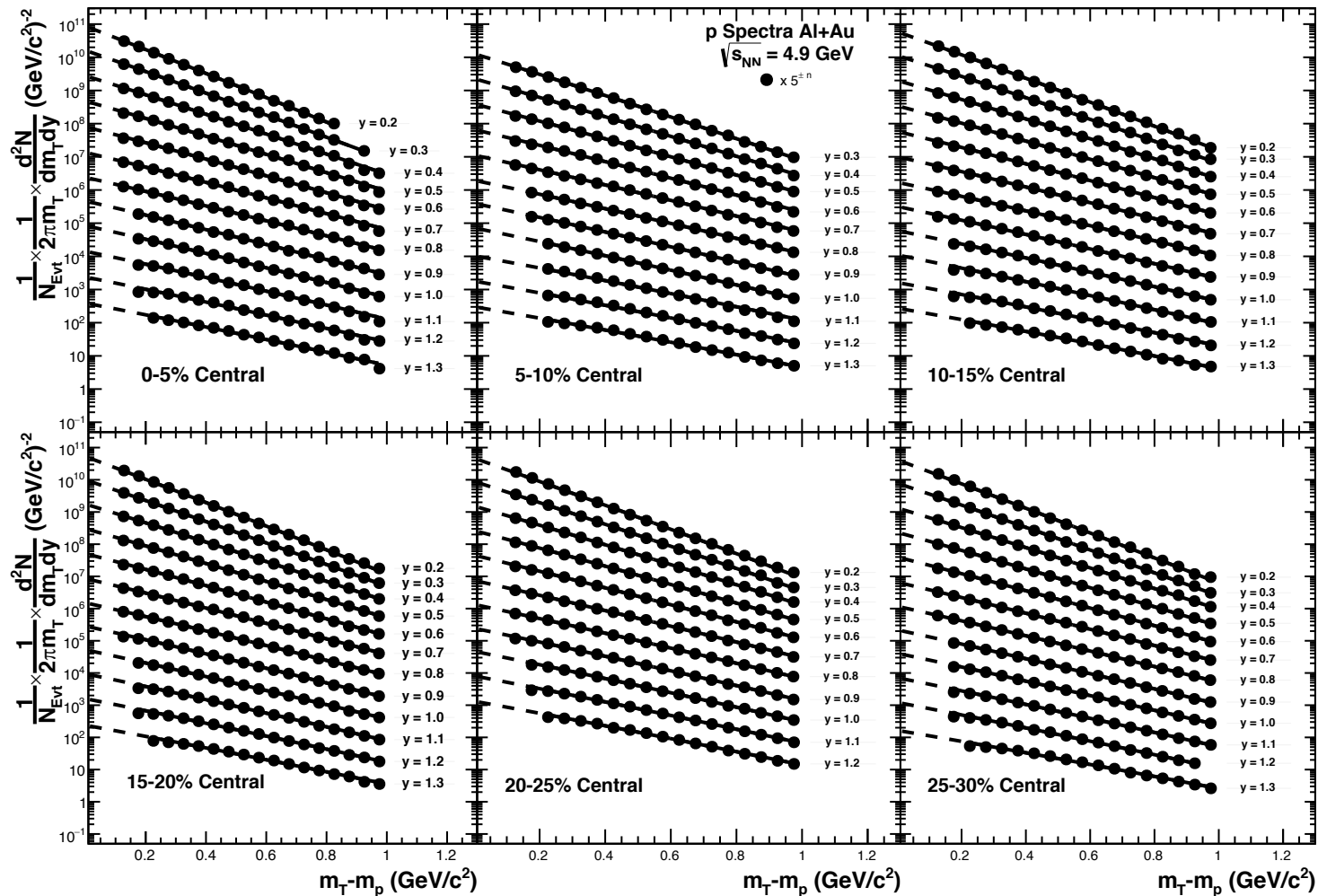

✓ $m_T - m_0$ range up to 1 GeV/c²

✓ Proton spectra for different rapidity bins and different centralities scaled by the factor of $5^{\pm n}$.

✓ Proton data is extrapolated to low $m_T - m_0$ with the thermal fitting function.

✓ Systematic uncertainties are included.

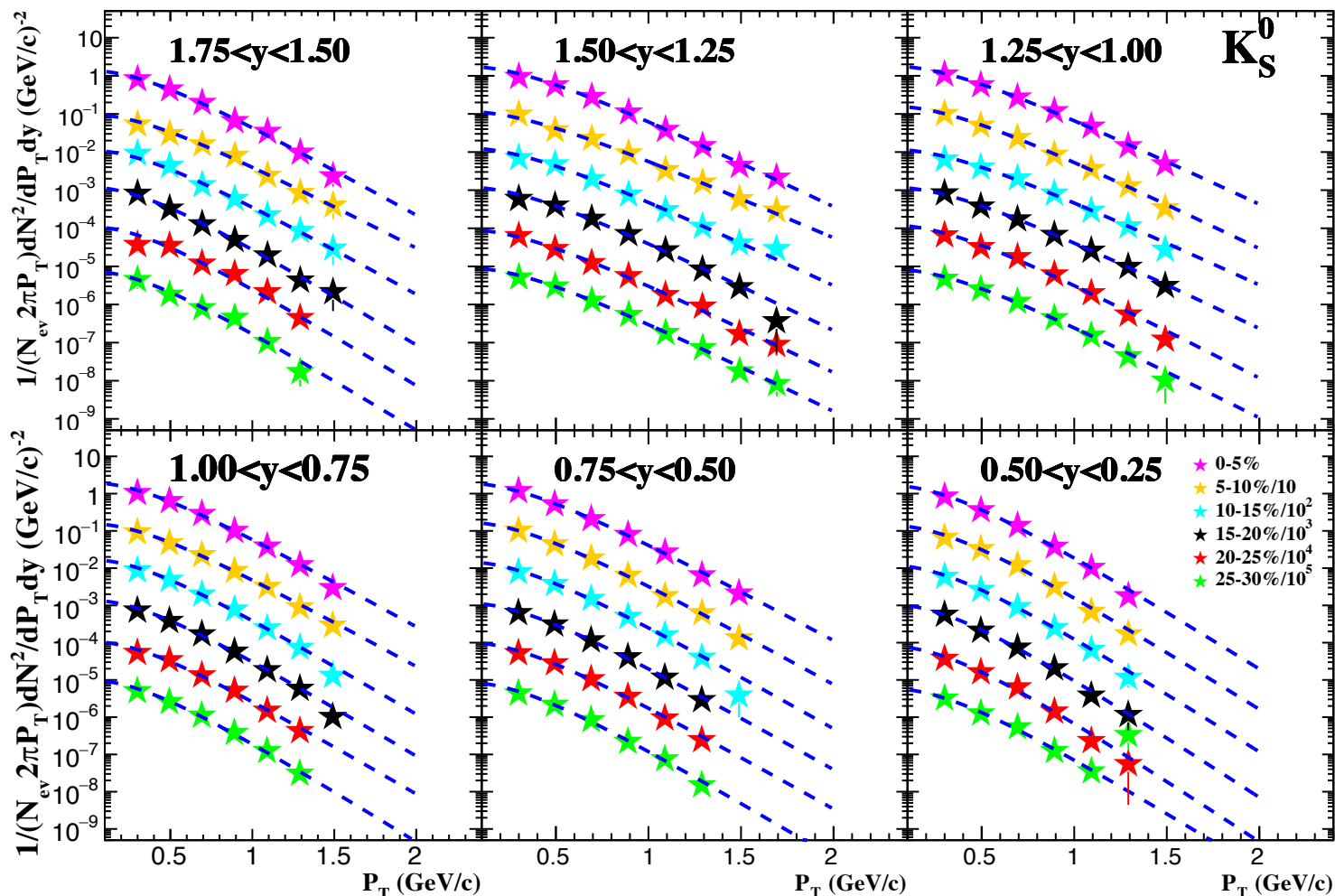

✓ P_T range upto 1.5 GeV/c

✓ K_S^0 spectra for different rapidity ranges and different centralities scaled by the factor of 10.

✓ K_S^0 data is extrapolated to low and high P_T with the exponential fitting function.

✓ Systematic uncertainties are included.

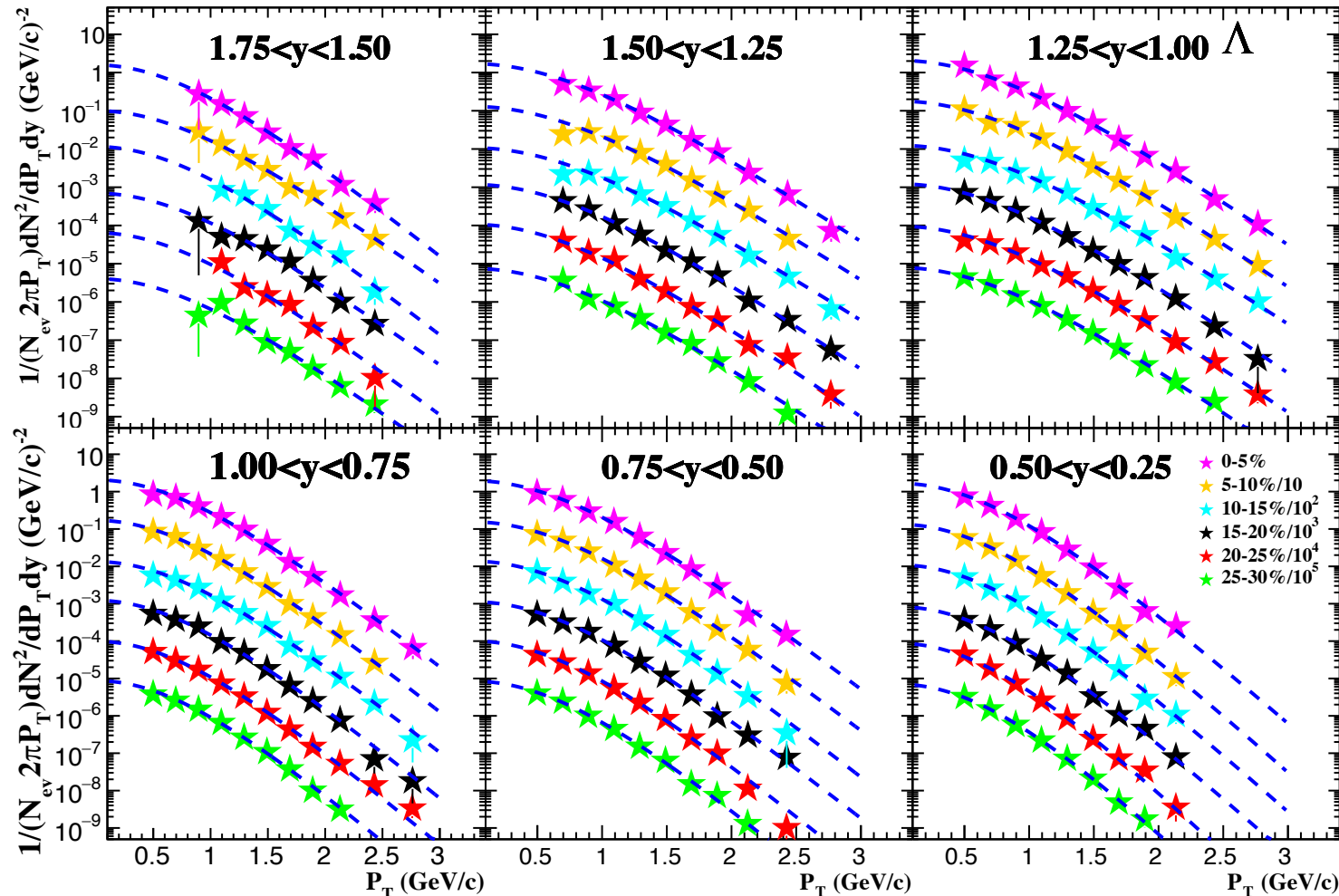

✓ P_T range upto 2.5 GeV/c

✓ Λ spectra for different rapidity ranges and different centralities scaled by the factor of 10.

✓ Λ data are extrapolated to low and high P_T with the Boltzmann fitting function.

✓ Systematic uncertainties are included.

π^- dN/dy Distributions

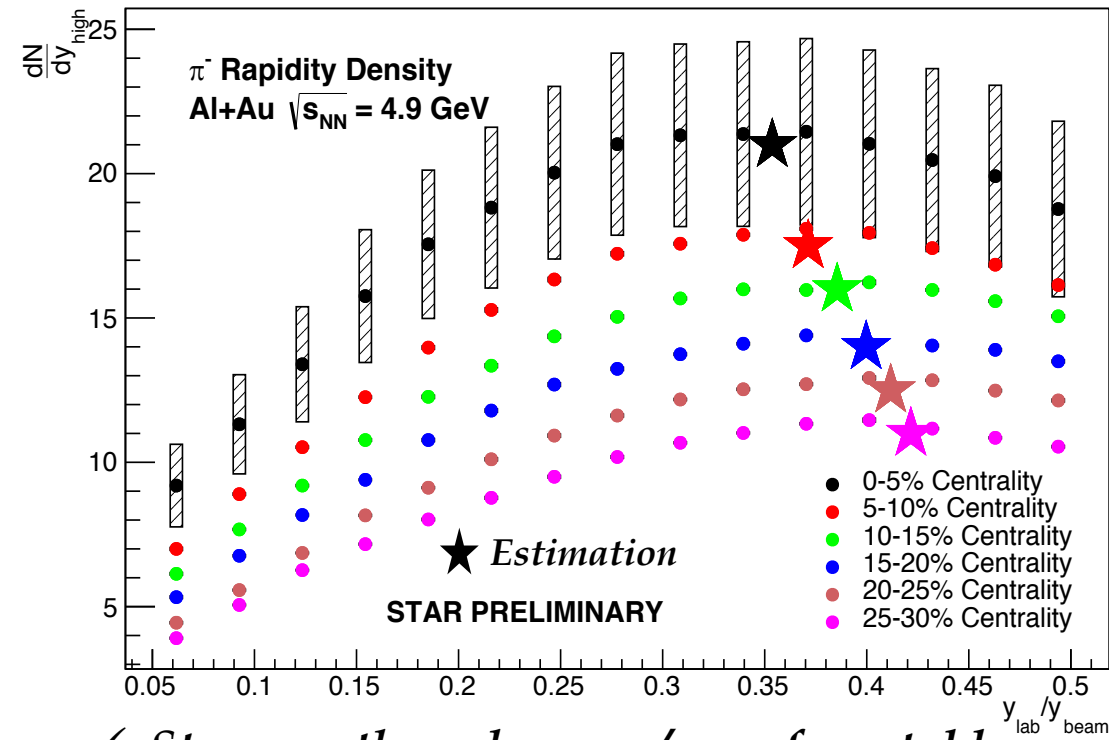

✓ Stars are the values y_{lab}/y_{beam} from table

$$y = \frac{1}{2} \ln \left(\frac{E+p_z}{E-p_z} \right)$$

$$p_z = \langle N_{part} \rangle^{Al} p_z^{beam}$$

$$E = \langle N_{part} \rangle^{Al} E^{beam} + \langle N_{part} \rangle^{Au} m_{nucleon}$$

$$m_{nucleon} = 931.5 \text{ MeV}$$

$$p_z^{beam} = 11.69 \text{ GeV}$$

$$E^{beam} = 11.73 \text{ GeV}$$

- ✓ π^- are produced by a source travelling with the rapidity of the interaction zone.
- ✓ The peak of π^- is shifted towards the interaction zone rapidity

| Centrality (%) | Y_{lab}/y_{beam} | $\langle N_{part} \rangle$ | $\langle N_{part} \rangle^{Al}$ | $\langle N_{part} \rangle^{Au}$ |
|----------------|--------------------|----------------------------|---------------------------------|---------------------------------|
| 0-5 | 0.354 | 100.3 | 26.51 | 73.78 |
| 5-10 | 0.371 | 89.28 | 25.89 | 63.39 |
| 10-15 | 0.389 | 80.01 | 24.92 | 55.09 |
| 15-20 | 0.400 | 70.20 | 23.43 | 46.77 |
| 20-25 | 0.412 | 61.16 | 21.59 | 39.57 |
| 25-30 | 0.422 | 53.13 | 19.62 | 33.51 |

Meson dN/dy Distributions

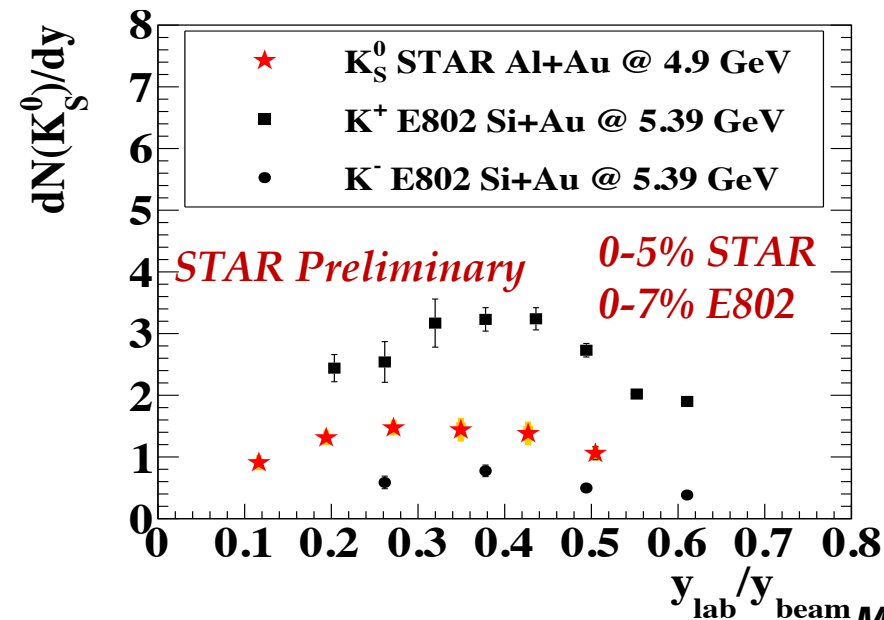
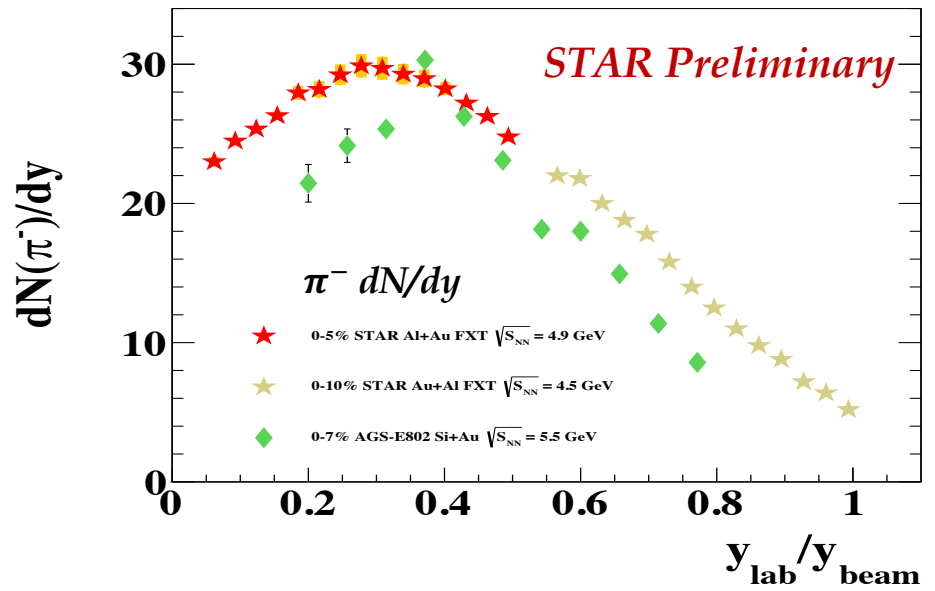
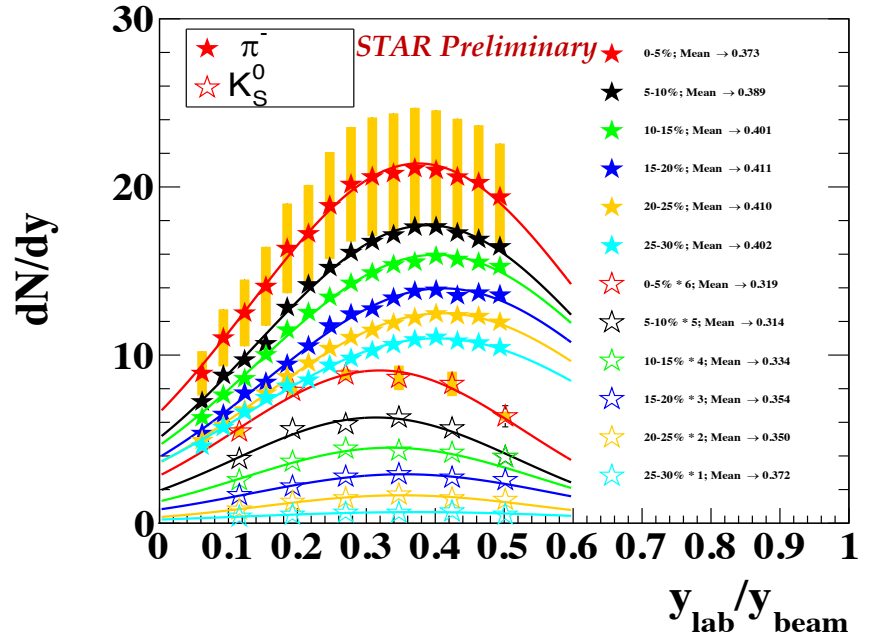
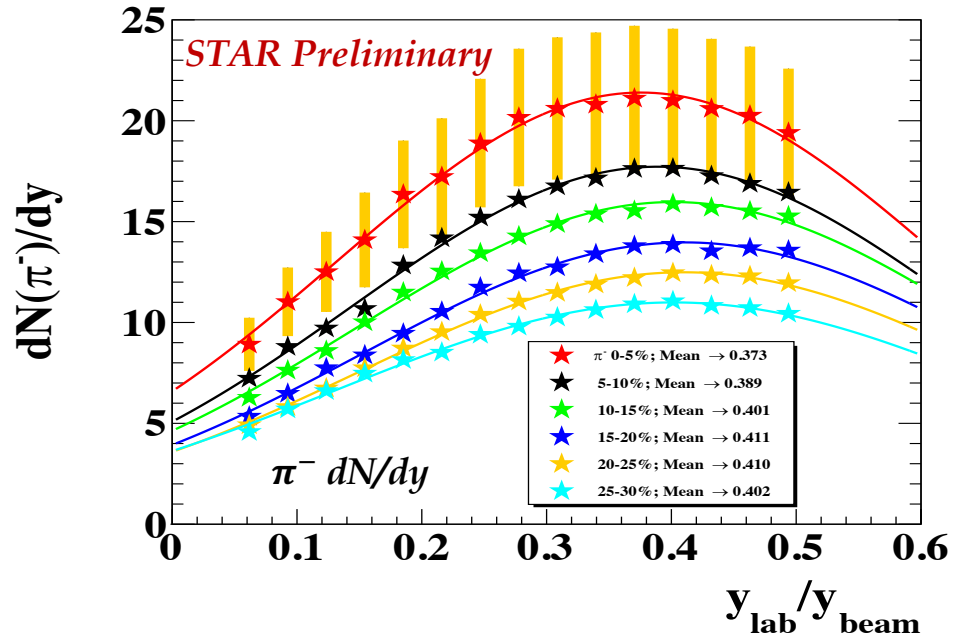
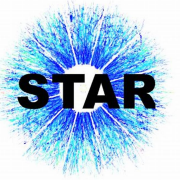

- ✓ π^- and K_S^0 peak are shifted towards the interaction zone rapidity.
- ✓ K_S^0 dN/dy distributions are scaled for better visualization.
- ✓ Significant difference, in the π^- dN/dy with AGS-E802 experiment, however when scaled, shapes are the same.
- ✓ 0-5% π^- and K_S^0 has the Systematic uncertainties.

Baryon dN/dy Distributions

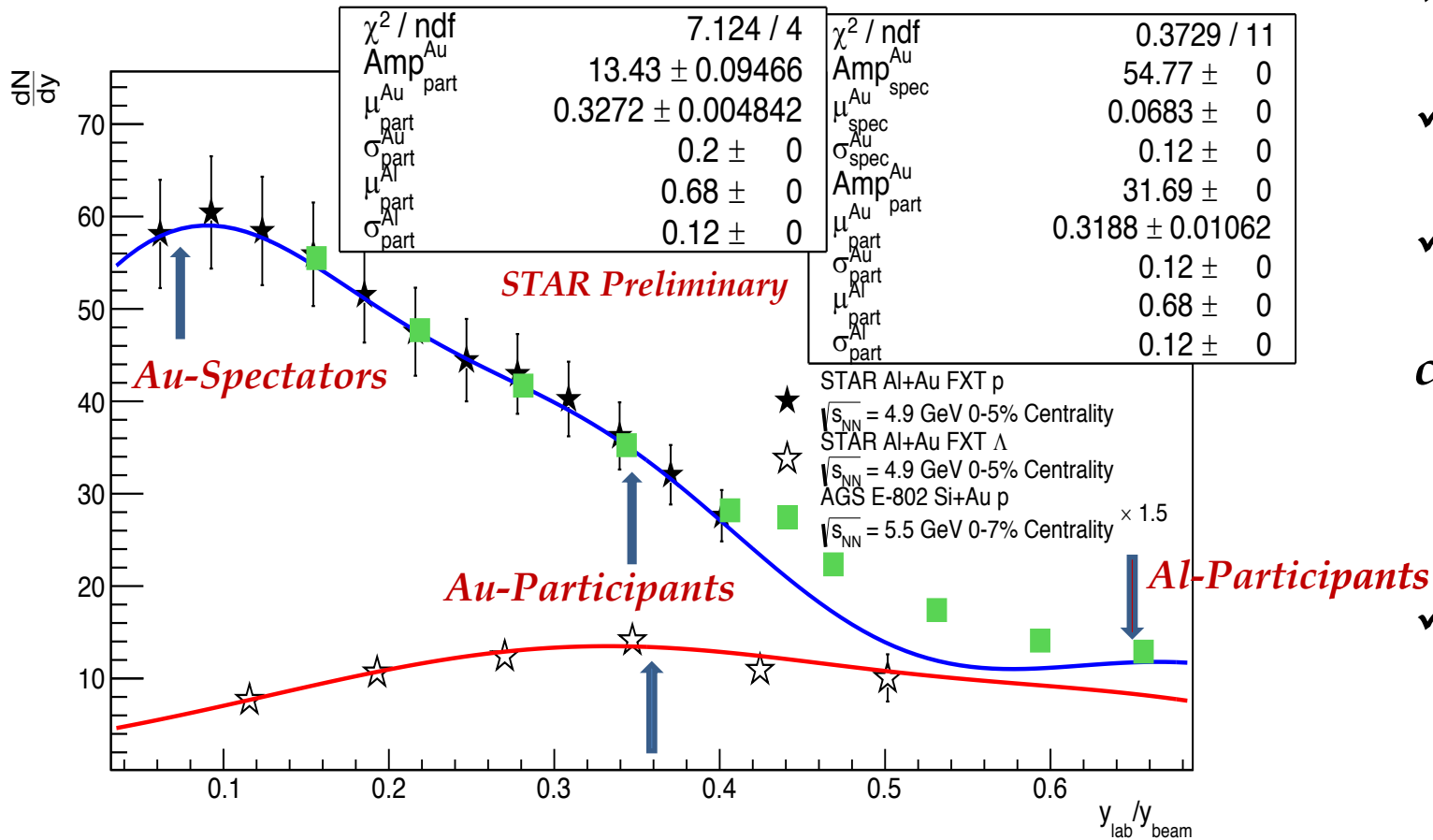

✓ Definition of Stopping is:

$$\delta_y = y_{\text{beam}} - y_{\text{peak}}$$

✓ For Au-Spectators $y_{\text{beam}} = 0$, and

$$\delta_y = y_{\text{peak}}$$

✓ For Au-Participants

$$y_{\text{peak}}/y_{\text{beam}} = 0.32$$

converting this back to the lab rapidity,

$$\delta_y = 0.32 * 3.24 = 1.03 \text{ (Proton)}$$

$$\delta_y = 0.33 * 3.24 = 1.06 \text{ (\Lambda)}$$

✓ For Al-Participants $y_{\text{peak}}/y_{\text{beam}} = 0.6886$

$$\delta_y = y_{\text{beam}} - y_{\text{peak}}$$

$$\delta_y = 1 - 0.6886 = 0.3114$$

converting this back to lab rapidity,

$$\delta_y = 0.3114 * 3.24 = 1.01$$

✓ Systematic uncertainty, added up in quadrature with statistical Error

for protons and Λ .

✓ No systematic error for AGS-E802 data points.

Baryon dN/dy Distributions

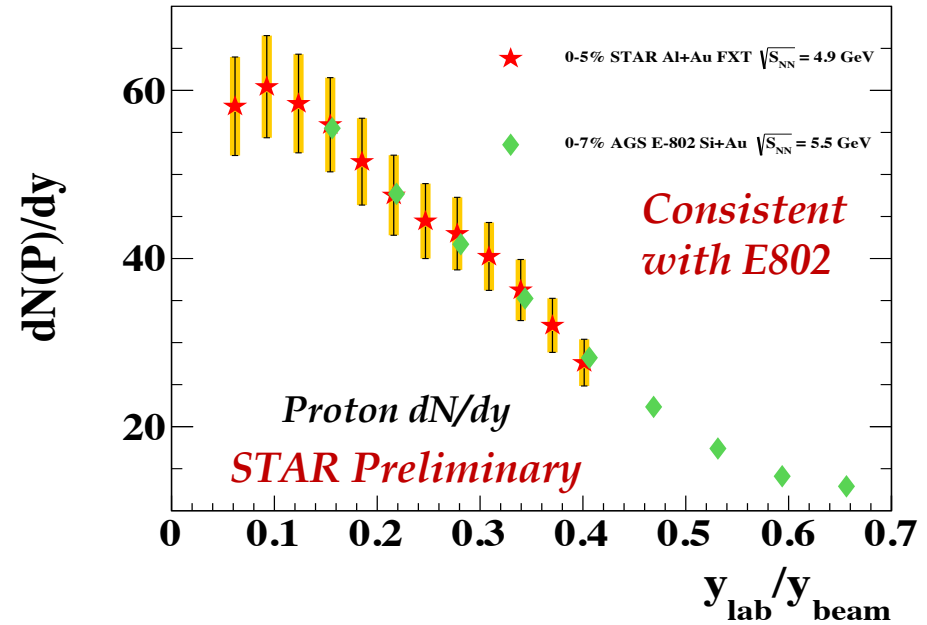
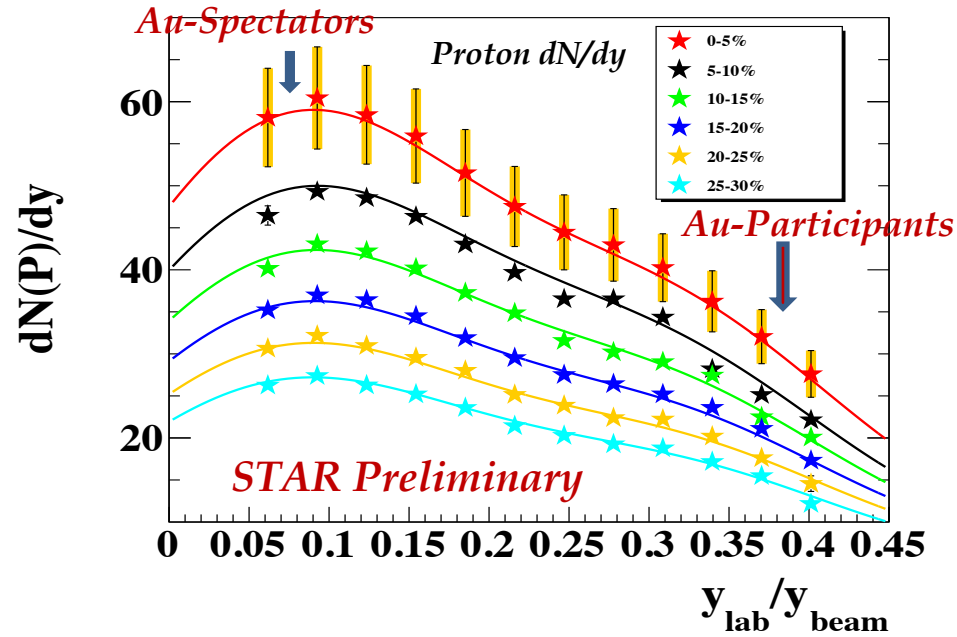

- ✓ 0-5% proton has systematic uncertainty, added up in quadrature with statistical error.
- ✓ Double Gaussian is used to fit Λ and proton dN/dy distributions.
- ✓ For protons Au-Participant peak is observed around **0.329**
- ✓ For Λ , Au-Participant peak is observed around **0.314**
- ✓ Λ peak is almost consistent to that of protons peak.
- ✓ 0-5% Λ dN/dy distributions has systematic uncertainty.

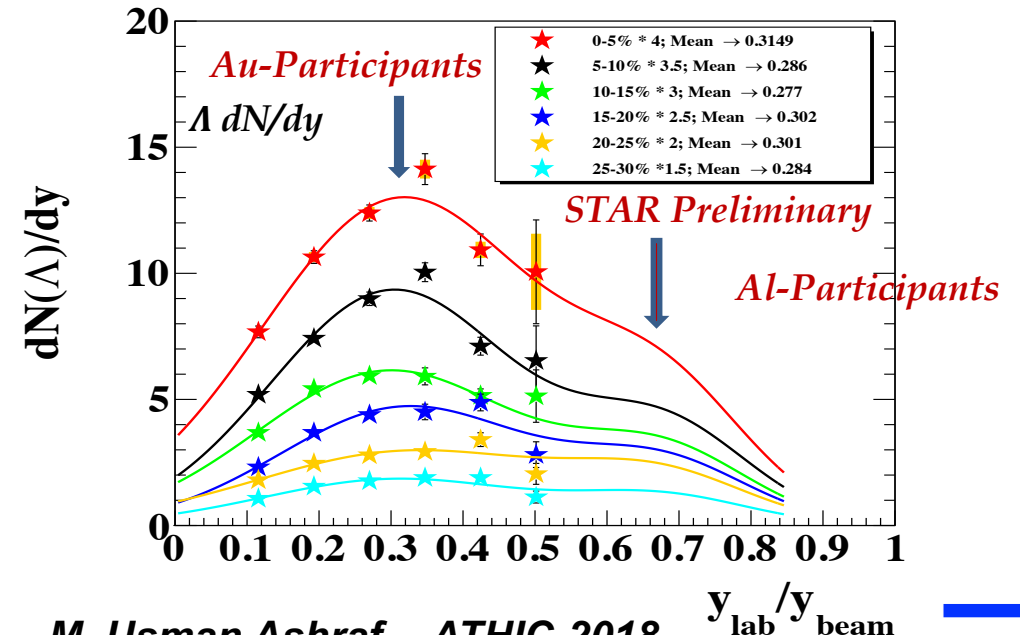

Summary Plot

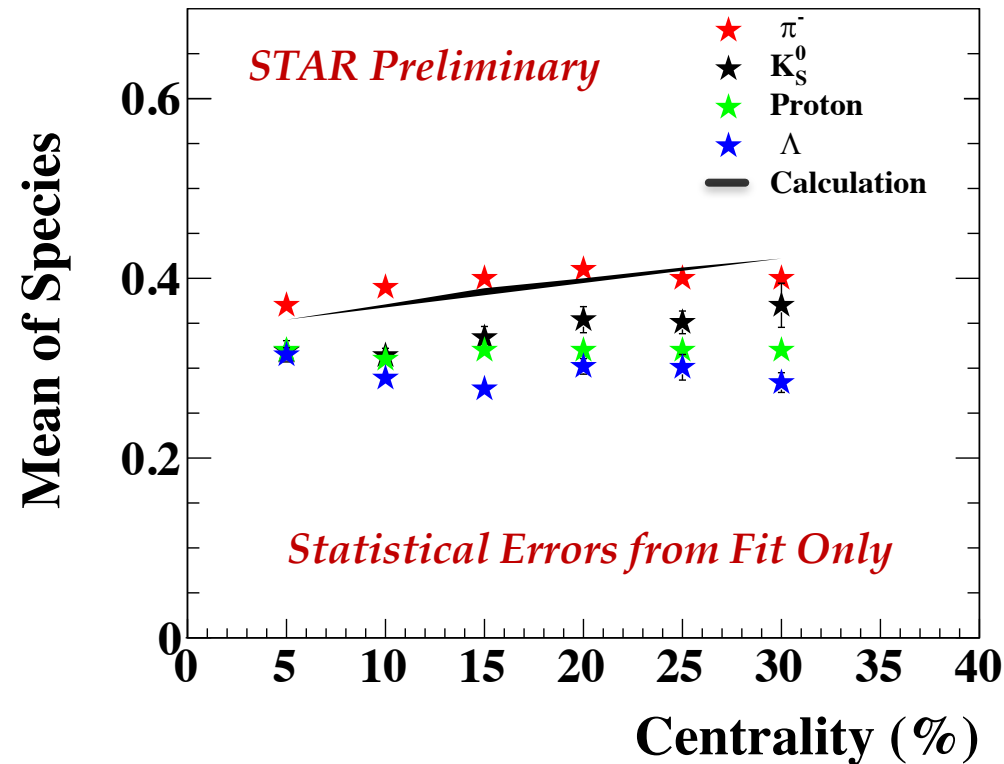

- ✓ The trend of the peaks of the K_S^0 and π^- dN/dy distributions are same, but the peak of K_S^0 is shifted toward the target by roughly 0.2 unity of rapidity.
- ✓ The proton dN/dy show both target and the interaction zone components. The Interaction zone component was used to estimate the stopping “ δy ” of the gold nucleons to be about 1.0
- ✓ The peak of the Λ dN/dy is consistent to the protons.

The STAR Upgrades and the FXT program

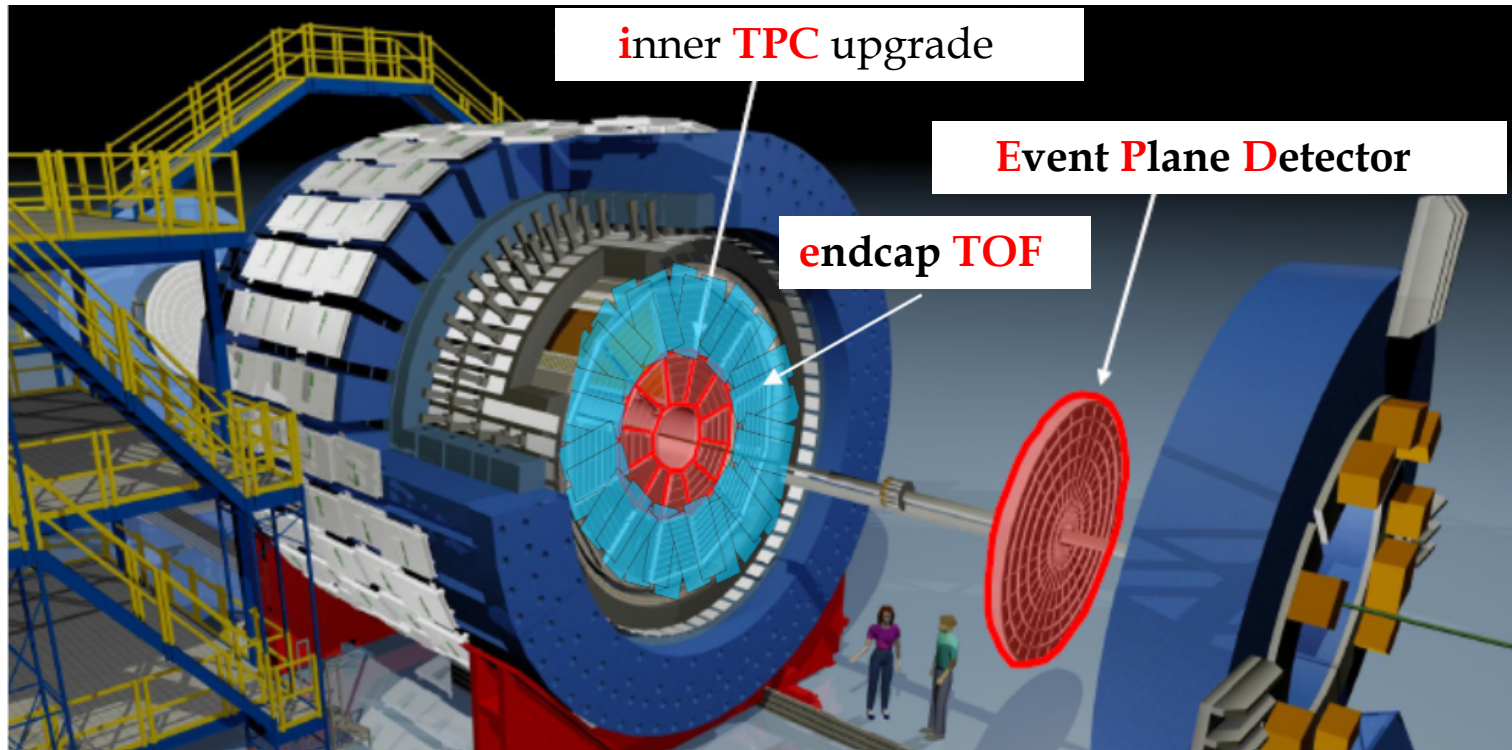

iTPC Upgrade:

- ✓ Improved dE/dx resolution
- ✓ Better momentum resolution
- ✓ Extends η coverage from 1.0 to 1.5
- ✓ $p_T > 60$ MeV/c
- ✓ Ready in 2019

EndCap TOF Upgrade:

- ✓ Mid-rapidity coverage is critical
- ✓ Needed for PID at mid-rapidity
- ✓ $-1.6 < \eta < -1.1$
- ✓ Allows higher energy range of FXT program
- ✓ Ready in 2019

EPD Upgrade:

- ✓ Better trigger
- ✓ Reduces background
- ✓ Improves event plane resolution
- ✓ $2.1 < |\eta| < 5.1$
- ✓ Ready in 2018

- ✓ Centroids of the high temperature component of the π^- yield is consistent with the interaction zone rapidity.
- ✓ The peak of the K_S^0 dN/dy distributions follows π^- , but is shifted toward the target by roughly 0.2 unit of rapidity.
- ✓ The proton dN/dy distributions show both target and the interaction zone components. The Interaction zone component was used to estimate the stopping " δy " of the gold nucleons to be about 1.0 units.
- ✓ The peak of the Λ dN/dy is consistent to the protons.
- ✓ FXT program proposed during RHIC BES-II will extend the energy down to $\sqrt{s_{NN}} = 3.0$ GeV ($\mu_B = 720$ MeV).
- ✓ iTPC, eTOF and EPD upgrades will allow more comprehensive and refined measurements.

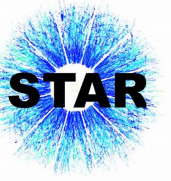

Thank You!
