

IHEP-CEPC-DR-2018-XX

IHEP-EP-2018-XX

IHEP-TH-2018-XX

CEPC

Conceptual Design Report

Volume II - Physics & Detector

The CEPC Study Group

Fall 2018

Draft-V1.0

Index

*** OUTSTANDING ISSUES ***, ii

Calorimeter - Figure 5.45: Improve resolution, increase size of legend, 231

Calorimeter - Figure 5.48: Substitute with proper resolution picture, 234

Calorimeter - Figure 7.2: crop pictures to increase size, 254

Calorimeter - Text: Move text into the introduction at start of chapter, 187

Calorimeter-ECAL - Check: check text and results for intrinsic performance, 190

Chapter 3 - DECISION: Remove any mention of the name IDEA and substitute it with alternative detector?, 130

Chapter 3 - Figure: Expand caption for IDEA detector, 132

Chapter 3 - Figure: expand caption., 114

Chapter 3 - Figure: update with labels., 127

Chapter 3 - Table: expand caption., 126

Introduction - Reminder - text to be added later:

A preliminary version of this Physics and Detector CDR was reviewed by an international review committee in September 2018. The comments from the reviewers have been taken into account in this final document, and details about it can be found in Appendix, 2

Magnet - Check: check number of size of yoke, 243

MDI - Text: Include beampipe information, 265

Performance - Check: check numbers below in red., 300

Performance - Check: check numbers in red below – several need update, 295

Performance - Figure 10.11: (b) update? change y-axis title, 295

Performance - Figure 10.15: comment on resolutions, at least for light jets., 299

Performance - Figure 10.9: update? (a) Comment on what photons are used for the resolution curves, 293

Performance - References: Check references..., 285

Silicon Tracker - Add Text: add information about sensors in baseline, and angles, etc., 162

Silicon Tracker - Figure: Let's make sure the baseline numbers are consistent with what we presented earlier in the baseline subsection, 174

Silicon Tracker - Text: check text for definitions and modify, 166

Silicon Tracker - Text: Edit strip detector details., 170

Theory - Figure: Update to add GeV to $m_H = 600$, 61

Theory - Numbers: update with most recent higgs coupling numbers, 9

Theory - Reference: refer to the physics potential section, 9

Theory - References: Higgs section, 39

Theory - Textual: Check text for the usage of the word Higgs, without boson. It should be "Higgs boson", 8

TPC - CHECK: Check overall recent modifications, 147

TPC - Figure 4.10: Expand caption of TPC read-out electronics, 151

TPC - Figure 4.1: Expand caption of TPC sketch, 147

TPC - Table 4.4: Expand caption , 152

vertex - clarification: When we move the first layer from 16 to 12 mm, does it still clear the beam pipe? In any case, what do we do with beam pipe radius in this study? It is the last scattering surface when extrapolating back and has impact on the answer. I think we need to clarify what has been studied., [141](#)

Draft-V1.0

ACKNOWLEDGMENTS

The CEPC Physics and Detector Conceptual Design Report (CDR) was prepared and written by the CEPC Study Group. The study was organised and led by scientists from the Institute of High Energy Physics (IHEP) of the Chinese Academy of Sciences (CAS), and from many universities and other institutes in China and abroad.

This work was supported by National Key Program for Science and Technology Research and Development (Grant no. 2016YFA0400400, 2018YFA0404300), The National Natural Science Foundation of China (Grant no. 11675202, 11575221), the Hundred Talent programs of Chinese Academy of Science (Grant no. Y3515540U1, Y71184005C), the general research program of Taiwan (Grant no. MOST-106-2112-M-001-023), the grant of Ta-You Wu memorial award (Grant no. 105-2112-M-008-022-MY3), the IHEP innovation Grant (Y4545170Y2, Y4545176Y2), Chinese Academy of Science Focused Science Grant (QYZDY-SSW-SLH002), Chinese Academy of Science Special Grant for Large Scientific Projects (113111KYSB20170005), The National 1000 Talents Program of China, The H2020 project AIDA2020 (GA no. 654168), The IHEP Xie Jialin fund (Grant no. Y8546120U2), The Corporation fund of Wuxi Toly Electric Works Co.Ltd, (Grant no. RD01-201401, RD03-201601)

...

Draft-V1.0

AUTHOR LIST

** To be updated soon **

CHINA

Institute of High Energy Physics, Chinese Academy of Sciences

Fenfen An, Guangpeng An , Sha Bai, Xiao Cai, Dewen Cao, Mingshui Chen, Jianping Dai, Mingyi Dong, Yaquan Fang, Jinyu Fu, Chengdong Fu , Jie Gao, Yu Gao, Huiping Geng , Joao Guimaraes da Costa , Shuang Han , Yukun Heng , Zhilong Hou , Jun Hu , Tao Hu , Xiaozhong Huang , Jiechen Jiang , Mingjie Jin , Maoqiang Jing , Ryuta Kiuchi , Gang Li , Jin Li , Ke Li , Mengran Li , Weiguo Li , Yiming Li , Jinyan Li , Hao Liang , Zhijun Liang , Libo Liao , Bo Liu , Bei Jiang Liu , Xuyang Liu , Yong Liu , Zhenan Liu , Zhongxiu Liu , Hu Liu , Yi Liu , Xinchou Lou , Yunpeng Lu , Weiguo Lu , Feipeng Ning , Qun Ouyang , Huirong Qi , Zhonghua Qin , Manqi Ruan , Lianyou Shan , Xin Shi , Xilei Sun , Jia Tao , Xing'cheng Tian , Jing Wang , Yifang Wang , Dou Wang , Jin Wang , Meifen Wang , Na Wang , "Yiwei " Wang , Zhigang Wang , Zhiyong Wang , Kechen Wang , Liangliang Wang , Linlin Wang , Yuqian Wei , Wei Wei , Mengqing Wu , Wenhuan Wu , Linghui Wu , Yuguang Xie , Qinglei Xiu , Wei Xu , Tian Yan , Huan Yang , Weichao Yao , Dan Yu , Boxiang Yu , Lu Yu , Chunxu Yu , Ye Yuan , Huaqiao Zhang , Kaili Zhang , Yao Zhang , Ying Zhang , Zhaoru Zhang , Zhenyu Zhang , Hongyu Zhang , Guoping Zhang , Xianghu Zhao , Hang Zhao , Ling Zhao , Mei Zhao , Wei Zhao , "Xiang " Zhou , Hongbo Zhu , Kejun Zhu , Yongfeng Zhu , Zian Zhu , Xuai Zhuang , Jiaheng Zou ,

Department of Modern Physics, University of Science and Technology of China

Jianxin Feng , Fangyi Guo , Daojin Hong , Jianbei Liu , Yazhou Niu , Yunlong Zhang , Zhiyong Zhang , Shensen Zhao ,

1
2
3
4
5
6
7
8
9
10
11
12
13
14
15
16
17
18
19
20
21
22
23
24
25
26
27
28
29
30
31
32
33
34
35
36

Shandong University

Jianing Dong, Cunfeng Feng, Xingtao Huang, Jianbin Jiao, Haifeng Li, Xiaoling Li, Shiyuan Li, Jian Liu, Lianliang Ma, Zonguo Si, Meng Wang, Liang Zhang, Xueyao Zhang, Chengguang Zhu,

China Institute of Atomic Energy

Mingrui Zhao

School of Physics, Peking University

Congqiao Li, Qiang Li, Yajun Mao, Dayong Wang, siguang Wang

Department of Engineering Physics Department, Tsinghua University

Xin Chen, Yuanning Gao, Tao Han, Boyang Li, Yulan Li, Yue Yu,

School of Physical Sciences, University of Chinese Academy of Science (UCAS)

Name1, Name2,....

School of Nuclear Science and Technology, University of South China

Name1, Name2,....

Department of Physics, Nanjing University

Shan Jin, Ming Qi,

Country

Institute

Name1, Name2,....

CONTENTS

2	Index	iii
3	Acknowledgments	v
4	Author List	vii
5	1 Executive Summary – Introduction	1
6	2 Overview of the physics case for CEPC	7
7	2.1 CEPC: the precision frontier	8
8	2.2 Higgs and electroweak symmetry breaking	11
9	2.2.1 Naturalness	11
10	2.2.2 Electroweak phase transition	19
11	2.3 Exploring new physics	28
12	2.3.1 Exotic Higgs boson decays	29
13	2.3.2 Exotic Z boson decays	31
14	2.3.3 Dark matter and hidden sectors	34
15	2.3.4 Neutrino connection	49
16	2.3.5 Extended Higgs sector	58
17	2.4 QCD precision measurement	62
18	2.4.1 Precision α_s determination	62
19	2.4.2 Jet rates at CEPC	64
20	2.4.3 Non-global logarithms	65
21	2.4.4 QCD event shapes and light quark Yukawa coupling	65
22	2.5 Flavor Physics with the Z factory of CEPC	66
23	2.5.1 Rare B decays	68
24	2.5.2 Tau decays	72
25	2.5.3 Flavor violating Z decays	74
26	2.5.4 Summary	75

1	3	Experimental Conditions, Physics Requirements and Detector Concepts	111
2	3.1	CEPC Experimental Conditions	112
3	3.1.1	The CEPC beam	112
4	3.1.2	Beam backgrounds	112
5	3.2	Physics Requirements	116
6	3.2.1	Multiplicity	116
7	3.2.2	Tracking	117
8	3.2.3	Charged Leptons	118
9	3.2.4	Charged hadron identification	119
10	3.2.5	Photons	119
11	3.2.6	Jets and Missing energy	121
12	3.2.7	Flavor Tagging	123
13	3.2.8	Requirements on the physics objects: summary	124
14	3.3	Detector concepts	125
15	3.3.1	The baseline detector concept	125
16	3.3.2	Full silicon detector concept	129
17	3.3.3	An alternative low magnetic field detector concept	130
18	4	Tracking system	137
19	4.1	Vertex tracker detector	137
20	4.1.1	Performance Requirements and Detector Challenges	138
21	4.1.2	Baseline design	138
22	4.1.3	Detector performance studies	138
23	4.1.4	Beam-induced Background in the Vertex Detector	141
24	4.1.5	Sensor Technology Options	142
25	4.1.6	Mechanics and Integration	144
26	4.1.7	Critical R&D	145
27	4.1.8	Summary	146
28	4.2	Time Projection Chamber and Silicon tracker	147
29	4.2.1	Time Projection Chamber	147
30	4.2.2	Silicon tracker	162
31	4.2.3	TPC and Silicon tracker performance	166
32	4.3	Full-silicon tracker detector	166
33	4.3.1	Full silicon tracker layout	167
34	4.3.2	Expected Resolution	168
35	4.3.3	Detector simulation and reconstruction	170
36	4.3.4	Tracking performance	174
37	4.3.5	Conclusion	174
38	4.4	Drift chamber tracker detector	175
39	4.4.1	Introduction	175
40	4.4.2	Overview	177
41	4.4.3	Expected performance	178
42	4.4.4	Tracking system simulation results	179
43	4.4.5	Backgrounds in the tracking system	180
44	4.4.6	Constraints on the readout system	181
45	5	Calorimetry	187
46	5.1	Introduction to calorimeters	187

1	5.2	General design considerations for the PFA Calorimetry system	190
2	5.3	Electromagnetic Calorimeter for Particle Flow Approach	190
3	5.3.1	Design Optimization	191
4	5.3.2	Silicon-Tungsten Sandwich Electromagnetic Calorimeter	194
5	5.3.3	Scintillator-Tungsten Sandwich Electromagnetic Calorimeter	198
6	5.4	Hadronic Calorimeter for Particle Flow Approach	204
7	5.4.1	Introduction	204
8	5.4.2	Semi-Digital Hadronic Calorimeter (SDHCAL)	205
9	5.4.3	AHCAL based on Scintillator and SiPM	214
10	5.5	Dual-readout calorimetry	219
11	5.5.1	Introduction	219
12	5.5.2	Principle of dual-readout calorimetry	220
13	5.5.3	Layout and mechanics	223
14	5.5.4	Sensors and readout electronics	224
15	5.5.5	Performance studies with fiber-sampling prototypes	227
16	5.5.6	Monte Carlo simulations	229
17	5.5.7	Final remarks	238
18	6	Detector magnet system	243
19	6.1	Magnetic field design	243
20	6.1.1	Main parameters	243
21	6.1.2	Magnetic field design	243
22	6.2	Solenoid coil	245
23	6.3	Ancillaries (cryogenics, power supply, quench protection)	245
24	6.3.1	Cryogenics system	245
25	6.3.2	Power supply	245
26	6.3.3	Quench protection and instrumentation	245
27	6.4	Iron yoke design	245
28	6.5	Alternative designs and R&D	246
29	6.5.1	LTS solenoid for the IDEA detector	246
30	6.5.2	HTS solenoid for IDEA detector	247
31	6.5.3	Dual solenoid design	247
32	6.5.4	Superconducting conductor	248
33	6.5.5	Thermosyphon circuit	248
34	7	Muon system	251
35	7.1	Baseline Design	252
36	7.2	The Resistive Plate Chamber technology	254
37	7.3	The μ -RWELL technology	254
38	7.4	Future R&D	255
39	8	Readout electronics, trigger and data acquisition	259
40	8.1	Trigger strategy	260
41	8.2	Readout electronics	260
42	8.3	Data Acquisition System	261
43	8.3.1	Readout Data Rate Estimation	261
44	8.3.2	Conceptual Design Schema	261

1	9	Machine detector interface and luminosity detectors	265
2	9.1	Interaction region	265
3	9.2	Final focusing magnets	266
4	9.3	Detector backgrounds	267
5	9.3.1	Synchrotron radiation	268
6	9.3.2	Beam-beam interactions	269
7	9.3.3	Off-energy beam particles	270
8	9.3.4	Summary of radiation backgrounds	272
9	9.4	Luminosity instrumentation	274
10	9.4.1	Technological and design options	275
11	9.4.2	Systematic effects	281
12	9.4.3	Summary on LumiCal	282
13	9.5	Detector integration	283
14	10	Simulation, Reconstruction and Physics Object Performance	285
15	10.1	Event simulation and reconstruction	285
16	10.1.1	Event simulation	285
17	10.1.2	Event reconstruction	286
18	10.2	Object Identifications and Performances	289
19	10.2.1	Leptons	289
20	10.2.2	Photons	291
21	10.2.3	Tau Leptons	293
22	10.2.4	Jets	294
23	10.2.5	Jet flavor tagging	296
24	10.2.6	Missing Energies, Momenta and Masses	297
25	10.2.7	Kaon Identification	299
26	10.3	Summary	299
27	11	Physics performance with benchmark processes	303
28	11.1	Higgs Boson Physics	304
29	11.1.1	Higgs boson production and decay	304
30	11.1.2	Higgs boson tagging	306
31	11.1.3	Measurements of $\sigma(ZH)$ and m_H	308
32	11.1.4	Analyses of individual Higgs boson decay modes	309
33	11.1.5	Combination of individual analyses	313
34	11.1.6	Higgs boson width	315
35	11.1.7	Higgs Boson Coupling Measurements	315
36	11.1.8	Tests of Higgs boson spin/ CP	329
37	11.1.9	Summary	331
38	11.2	W and Z Boson Physics	332
39	11.2.1	Z pole measurements	332
40	11.2.2	Measurement of the W boson mass	339
41	11.2.3	Oblique Parameter	343
42	12	Future plans and R&D prospects	359
43	12.1	Tracking	359
44	12.1.1	Vertex	359
45	12.1.2	Silicon tracker	360

1	12.1.3	TPC	360
2	12.1.4	Full-silicon tracker	360
3	12.1.5	Drift Chamber tracker	360
4	12.2	Calorimetry	361
5	12.2.1	PFA-ECAL	361
6	12.2.2	PFA-HCAL	362
7	12.2.3	Dual-readout calorimeter	362
8	12.3	Magnet	363
9	12.4	Muon system	363
10	12.5	DAQ	363
11	12.6	Machine detector interface	364
12	12.7	Physics objects performance	364
13	12.8	Engineering and Detector Integration	364
14	12.9	Physics	364
15	12.9.1	Higgs Physics	364

Draft-V1.0

Draft-V1.0

CHAPTER 1

EXECUTIVE SUMMARY – INTRODUCTION

1 The discovery of the Higgs boson in 2012 by the ATLAS and CMS collaborations [1, 2]
2 at CERN’s Large Hadron Collider (LHC) opened a new era in particle physics and raised
3 new opportunities for a large-scale accelerator. Due to the low mass of the Higgs, it is
4 possible to produce it in the relatively clean environment of a circular electron-positron
5 collider with reasonable luminosity, technology, cost and power consumption. The Higgs
6 boson is a crucial cornerstone of the Standard Model (SM). It is at the center of the biggest
7 mysteries of modern particle physics, such as the large hierarchy between the weak scale
8 and the Planck scale, the nature of the electroweak phase transition, and many other re-
9 lated questions. Precise measurements of the properties of the Higgs boson, together with
10 precise measurements of the W and Z bosons, serve as excellent tests of the underlying
11 fundamental physics principles of the SM, and they are instrumental in explorations be-
12 yond the SM. Such physics program will be a critical component of any roadmap for high
13 energy physics in the coming decades.

14 The Circular Electron Positron Collider (CEPC) is a large international scientific project
15 initiated and hosted by China. It was first presented to the international community at the
16 ICFA Workshop “Accelerators for a Higgs Factory: Linear vs. Circular” (HF2012) in
17 November 2012 at Fermilab. A Preliminary Conceptual Design Report (Pre-CDR) [3, 4]
18 was published in March 2015.

19 This document is the second volume of the CEPC Conceptual Design Report (CDR).
20 Its main purpose is to address the physics potential of the CEPC, possible detector con-
21 cepts and the corresponding R&D program. The first volume [5], released in July 2018,
22 describes the CEPC accelerator complex design, associated civil engineering and strategic
23 alternative scenarios.

1 The CEPC operation will be staged in a few steps of center-of-mass energy to maximize
2 its physics potential. It is expected the CEPC to start operations at 240 GeV, giving raise
3 to a wealth of Higgs physics, and then move to lower center-of-mass energies and collect
4 large samples of W and Z bosons. This complete program of precision standard-model
5 physics will place stringent constraints on new physics, and it has the potential for direct
6 observation of new physics.

7 This CDR volume presents the essential features of the detectors that are required
8 to extract the full physics potential of the CEPC. The experimental conditions at high-
9 luminosity high-energy circular electron positron colliders present different challenges
10 than those for electron-positron linear colliders due to the higher levels of beam-induced
11 backgrounds, and the high-luminosity required to collect the extremely large samples of
12 Z boson events. A main goal of this report is to demonstrate that, expanding on the on-
13 going R&D program, a wide range of high-precision physics measurements can be made
14 at CEPC with detectors that are feasible to complete in the next 12-15 years.

15 Consequently, part of this report is devoted to understanding the impact of the machine
16 environment on the detector with the aim of demonstrating, with the example of a few
17 realistic detector concepts, that high-precision physics measurements can be made at the
18 CEPC. This document concentrates on the detector requirements and physics measure-
19 ments at the highest CEPC center-of-mass energy of 240 GeV, when the beam induced
20 backgrounds are higher, but consideration is also given to the high-rate operation at the
21 Z -boson mass energy.

22 This volume of the CEPC CDR consists of 12 chapters. The next chapter presents an
23 overview of the physics case for the CEPC, where the physics potential for both SM pre-
24 cision measurement and searches beyond the SM is highlighted. Chapter 3 introduces the
25 CEPC accelerator and the experimental environment and lists the detector requirements
26 that must be met to achieve the CEPC physics goals. This chapter ends with the intro-
27 duction of the CEPC detector concepts proposed to satisfy these physics requirements.
28 The detector subsystems are then described together in more detailed in the subsequent
29 chapters. Chapter 4 describes the tracking systems of all detector concepts, including the
30 vertex detectors. Chapter 5 presents the calorimeter options, while Chapter 7 describes
31 the muon system concepts. Results from detailed full simulation and test beam studies
32 are presented when available. The challenges referring to the design of the interaction re-
33 gion are described in Chapter 9, together with the beam backgrounds and details about the
34 plans for the luminosity measurement. The design of the detector solenoid is addressed in
35 Chapter 6, while a summary plan for the readout electronics and data acquisition system
36 is presented in Chapter 8. The overall performance of the CEPC baseline detector concept
37 is presented in Chapters 10 and 11. Chapter 10 introduces the detector software used in
38 the studies and details the physics object performance, taking into account full detector
39 simulation and reconstruction. Chapter 11 demonstrates the full physics potential of the
40 CEPC by emphasizing selected benchmark physics results. Finally, Chapter 12 ends this
41 report with an overview of future plans on detector R&D and physics studies towards the
42 Technical Design Report.

43 In what follows we present a short executive summary of the CDR content, highlighting
44 the CEPC physics case, the collider and experimental environment, the detector concepts,
45 and the physics performance and benchmarks.

1 **Physics Case** The precision measurement of Higgs properties will be a critical com-
 2 ponent of any roadmap for high energy physics in the coming decades. In addition to
 3 motivating new physics beyond the SM, the Higgs provides a uniquely sensitive probe
 4 of new physics. New physics beyond the SM can lead to observable deviations in Higgs
 5 boson couplings relative to SM expectations. These, and other electroweak physics pa-
 6 rameters, can be measured at the CEPC with unprecedented precision. Such measurements
 7 can be used to address important open questions of the electroweak symmetry breaking.
 8 The most important question about the electroweak symmetry is to explain the size of
 9 the weak scale, which is much smaller than some of the fundamental scales, such as the
 10 Planck scale. The idea of naturalness has been crucial in constructing solutions of this so
 11 called hierarchy problem. At the CEPC, it is possible to test the idea of naturalness to an
 12 unprecedented level. They can be used to probe fine-tuning down to the percent level in
 13 the conventional scenarios such as Supersymmetry and Composite Higgs. They are also
 14 sensitive to the signals of a range of newly developed ideas, from the neutral naturalness
 15 to the relaxion. In addition, the precision Higgs coupling measurements can help probing
 16 the global feature of the Higgs potential, and reveal the nature of the electroweak phase
 17 transition. Understanding electroweak phase transition marks another concrete step for-
 18 ward in our knowledge of the early universe, and it could hold the key to solve the problem
 19 of asymmetry between matter and anti-matter in our universe. It is argued that in addition
 20 to the triple Higgs coupling, models with first order electroweak phase transition generi-
 21 cally predict significant deviations in other Higgs couplings. An important example is the
 22 modification of the coupling of the Higgs boson to the Z boson which can be measure
 23 with sub-percent level accuracy at the CEPC.

24 The CEPC can also search for a variety of new physics particles. Running as both a
 25 Higgs-boson factory and a Z -boson factory, the exotic decays of Higgs and Z bosons can
 26 be used to search for new physics, such as those associated with a light dark sector. The
 27 CEPC can also search for dark matter, both through direct production and through its indi-
 28 rect effects on electroweak precision measurements. There is also an exciting possibility
 29 of direct producing the right handed neutrino and probe a class of see-saw models. Finally,
 30 both direct search and indirect measurement can look for signals of a possible extended
 31 Higgs sector.

32 A lepton collider is an excellent place to perform precise QCD measurement, and fur-
 33 ther our understanding of the strong interaction. Possible topics, include measurement of
 34 α_s , jet, event shapes and their utility in probing light Yukawa couplings. The CEPC can
 35 also produce close to 10^{12} Z bosons. Hence, it can be a powerful B -factory and τ -factory
 36 with excellent physics potential. At the same time, new flavor physics may show up as
 37 rare flavor violating Z decays.

38 **Collider and the Experimental Environment** The CEPC is a double-ring e^+e^- collider
 39 with 100 km circumference and two interaction points (IP). It will operate in three differ-
 40 ent modes, corresponding to three different center-of-mass energies (\sqrt{s}): Higgs factory
 41 ($e^+e^- \rightarrow ZH$) at $\sqrt{s} = 240$ GeV, Z boson factory ($e^+e^- \rightarrow Z$) at $\sqrt{s} = 91.2$ GeV and
 42 W threshold ($e^+e^- \rightarrow W^+W^-$) at $\sqrt{s} = \sim 160$ GeV. The instantaneous luminosities are
 43 expected to reach 3×10^{34} , 32×10^{34} and 10×10^{34} $\text{cm}^{-2}\text{s}^{-1}$, respectively, as shown in
 44 Table 1.1. The current tentative operation plan will allow the CEPC to collect one million
 45 Higgs particles or more, close to one trillion Z boson events, and ten million W^+W^-
 46 event pairs.

Operation mode	\sqrt{s} (GeV)	L per IP ($10^{34} \text{ cm}^{-2}\text{s}^{-1}$)	Years	Total $\int L$ (ab^{-1} , 2 IPs)	Event yields
H	240	3	7	5.6	1×10^6
Z	91.2	32 (*)	2	16	7×10^{11}
W^+W^-	158-172	10	1	2.6	2×10^7

Table 1.1: CEPC operation plan at different center-of-mass energies (\sqrt{s}), and corresponding anticipated instantaneous luminosity (L), total integrated luminosity ($\int L$) and event yields. (*) The maximum instantaneous luminosity achievable at the Z pole operation is dependent on the detector solenoid magnet field. The value reported here assumes a 2 Tesla solenoid.

The detectors will record collisions in beam conditions presented in Table 3.1. Several of these parameters impose important constraints on the detectors. The bunch spacing of the colliding beams differ greatly in the three operational modes (680 ns, 25 ns, and 210 ns, respectively) as do the background levels and event rates. The three most important sources of radiation backgrounds are (1) synchrotron radiation photons from the last bending dipole magnet, (2) e^+e^- pair production following the beamstrahlung process, and (3) off-energy beam particles lost in the interaction region. These backgrounds generate a hit density in the first vertex detector layer ($r = 1.6$ cm) of about 2.4 hits/cm² per bunch crossing when running at $\sqrt{s} = 240$ GeV and tolerable levels of the total ionizing energy (TID) and non-ionizing energy loss (NIEL). The event rate reaches ~ 32 kHz for Z factory operation from Z boson decays and Bhabha events.

Detector Concepts The CEPC detector concepts are based on the stringent performance requirements needed to deliver a precision physics program that tests the Standard Model and searches for new physics over a wide range of center-of-mass energies and at high beam luminosities. These specifications include large and precisely defined solid angle coverage, precise track momentum resolution, high efficiency vertex reconstruction, precise photon energy reconstruction, excellent particle identification, excellent jet reconstruction and flavor tagging.

The physics program demands that all possible final states from decays of the intermediate vector bosons, W and Z , and the Higgs boson need to be separately identified and reconstructed with high resolution. In particular, to clearly discriminate the $H \rightarrow ZZ^* \rightarrow 4j$ and $H \rightarrow WW^* \rightarrow 4j$ final states, the energy resolution of the CEPC calorimetry system for hadronic jets needs to be pushed quite beyond today's limits. The $H \rightarrow \gamma\gamma$ decay and the search for $H \rightarrow$ invisible decays impose additional requirements on energy and missing energy measurement resolutions. To measure the coupling of the Higgs boson to the charm quark, the CEPC detectors are required to efficiently distinguish b -jets, c -jets, and light jets from each other. To achieve excellent sensitivity for the $H \rightarrow \mu^+\mu^-$ decay the momentum resolution is required to achieve a per mille level relative accuracy. The latter two requirements drive the performance of the vertex detector and tracking systems.

Two primary detector concepts were studied, a baseline detector concept with two approaches to the tracking systems, and an alternative detector concept with a different strategy for meeting the jet resolution requirements. The baseline detector concept in-

1 incorporates the Particle Flow principle with a precision vertex detector, Time Projection
 2 Chamber and silicon tracker, 3T solenoid, and a high granularity calorimeter followed
 3 by muon chambers. A variant of the baseline detector concept incorporates a full sili-
 4 con tracker. An alternative detector concept is based on dual readout calorimetry with a
 5 precision vertex detector, drift chamber tracker, 2T solenoid, and muon chambers. The
 6 different technologies for each detector sub-system are being pursued actively with R&D
 7 programs and provide many opportunities to leverage leading advances in detector devel-
 8 opment in the coming years.

9 **Performance and Physics Benchmarks** Precise measurements of the Higgs boson prop-
 10 erties and the electroweak observables at the CEPC place stringent requirements on the
 11 performance of the CEPC detectors to identify and measure physics objects such as lep-
 12 tons, photons, jets and their flavors with high efficiencies, purities and precision. The per-
 13 formances of the CEPC baseline detector concept have been investigated with full simula-
 14 tion. Electrons and muons with momenta above 2 GeV and photons with energies above
 15 5 GeV can be identified with efficiencies of nearly 100% and with negligible backgrounds.
 16 Jets from W , Z and Higgs boson decays can be measured with an energy resolution of
 17 3–5%, allowing an average 2σ or better separation of hadronic decays of these bosons.
 18 Heavy-quark jets can be tagged with unprecedented efficiencies and purities. K^\pm can be
 19 distinguished from π^\pm with a significance better than 2σ . These performance results can
 20 be further improved with more optimizations and better calibrations.

21 Many new physics models predict deviations of Higgs boson couplings to their particles
 22 at the sub-percent level, beyond those achievable at the (HL-)LHC. The CEPC comple-
 23 ments the LHC and will be able to study the properties of the Higgs boson in great details
 24 with unprecedented precision. With over 10^6 Higgs bosons produced, most of the Higgs
 25 boson couplings can be measured with precision at a percent level or better, in particular
 26 the coupling to the Z boson can be determined with a precision of 0.25%. More impor-
 27 tantly, the CEPC will be able to measure many of the key Higgs boson properties such as
 28 the total width and decay branching ratios model independently. The clean event environ-
 29 ment of the CEPC will allow the identifications of potential unknown decay modes that
 30 are impractical at the LHC.

31 Beyond the Higgs boson physics, the CEPC will reach a new level of precision for
 32 the measurements of the properties of the W and Z bosons. With samples of 10^8 W
 33 bosons and 10^{12} Z bosons at the CEPC, an order of magnitude improvements in precision
 34 are expected for many electroweak observables. Precise measurements of the W and Z
 35 boson masses, widths, and couplings are critical to test the consistency of the Standard
 36 Model (SM). These measurements could discover deviations from the SM predicitions
 37 and reveal the existence of new particles that are beyond the reaches of direct searches at
 38 the current experiments. These new particles are predicted by many extensions of the SM.

39 This report provides a snapshot of the current studies, many of them are ongoing and
 40 more analyses are needed to fully explore the physics potential of the CEPC. Nevertheless,
 41 the performance results presented have either already met or are close to meet the require-
 42 ments of the CEPC experiments. Studies of physics benchmark processes suggest that the
 43 CEPC has the potential to “undress” the Higgs boson, similarly to what LEP did to the
 44 Z boson, and significantly improve the precision of electroweak measurements, ultimately
 45 shedding light on new physics.

1 **Future Plans** The CEPC construction is expected to start in 2022 and be completed in
2 2030, followed by the commissioning of the accelerator and detectors. A tentative op-
3 erational plan covers 10 years of physics data: 7 years for Higgs physics, followed by 2
4 years operation in Z mode and 1 year operation in W mode. Prior to the construction
5 there will be a five-year R&D period (2018-2022). During this period, two international
6 collaborations will be formed to produce Technical Design Reports, build and operate
7 two large experiments. Prototypes of key-technical detector components will be built,
8 and worldwide infrastructure established for industrialization and manufacturing of the
9 required components.

10 The CEPC is an important part of the world plan for high-energy particle physics re-
11 search. It will support a comprehensive research program by scientists from all over the
12 world and provide leading educational opportunities for universities and research insti-
13 tutes in China and around the world. Physicists from many countries will work together
14 to explore the science and technology frontiers, and to bring a new level of understanding
15 of the fundamental nature of matter, energy and the universe.

16 References

- 17 [1] The ATLAS Collaboration, G. Aad et al., *Observation of a new particle in the search*
18 *for the Standard Model Higgs boson with the ATLAS detector at the LHC*, *Phys. Lett.*
19 *B* **716** (2012) 1–29, [arXiv:1207.7214 \[hep-ex\]](#).
- 20 [2] The CMS Collaboration, S. Chatrchyan et al., *Observation of a new boson at a mass*
21 *of 125 GeV with the CMS experiment at the LHC*, *Phys. Lett.* **B716** (2012) 30–61,
22 [arXiv:1207.7235 \[hep-ex\]](#).
- 23 [3] The CEPC-SPPC Study Group, *CEPC-SPPC Preliminary Conceptual Design*
24 *Report, Volume I - Physics and Detector*, . IHEP-CEPC-DR-2015-01,
25 IHEP-TH-2015-01, IHEP-EP-2015-01.
- 26 [4] The CEPC-SPPC Study Group, *CEPC-SPPC Preliminary Conceptual Design*
27 *Report, Volume II - Accelerator*, 2015. IHEP-CEPC-DR-2015-01,
28 IHEP-AC-2015-01.
- 29 [5] The CEPC Study Group, *CEPC Conceptual Design Report, Volume I - Accelerator*, .
30 IHEP-CEPC-DR-2018-01, IHEP-AC-2018-01, to be published.

CHAPTER 2

OVERVIEW OF THE PHYSICS CASE FOR CEPC

1 After a very brief summary of the projections of the precision of Higgs coupling and elec-
2 troweak measurements, the next part of this chapter describes the potential of using these
3 measurements to address important open questions of the electroweak symmetry break-
4 ing. First, the most important question about the electroweak symmetry is to explain the
5 size of the weak scale, which is much smaller than some of the fundamental scales, such as
6 the Planck scale. The idea of naturalness (Section 2.2.1) has been crucial in constructing
7 solutions of this so called hierarchy problem. At the CEPC, it is possible to test the idea of
8 naturalness to an unprecedented level. They can be used to probe fine-tuning down to the
9 percent level in the conventional scenarios such as Supersymmetry and Composite Higgs.
10 They are also sensitive to the signals of a range of newly developed ideas, from the neu-
11 tral naturalness to the relaxion. In addition, the precision Higgs coupling measurements
12 can help probing the global feature of the Higgs potential, and reveal the nature of the
13 electroweak phase transition. Understanding electroweak phase transition (Section 2.2.2)
14 marks another concrete step forward in our knowledge of the early universe, and it could
15 hold the key to solve the problem of asymmetry between matter and anti-matter in our
16 universe. It is argued that in addition to the triple Higgs coupling, models with first order
17 electroweak phase transition generically predict significant deviations in other Higgs cou-
18 plings. An important example is the modification of the coupling of the Higgs boson to
19 the Z boson which can be measure with sub-percent level accuracy at the CEPC. This is
20 demonstrated in a representative scenario of singlet extension of the Higgs sector.

21 The CEPC can also search for a variety of new physics particles. Section 2.3 contains a
22 set of such examples. Running as both a Higgs factory and a Z -factory, the exotic decays
23 of Higgs and Z bosons can be used to search for new physics, such as those associated with
24 a light dark sector. CEPC can also search for dark matter (Section 2.3.3), both through

1 direct production and through its indirect effects on electroweak precision measurements.
 2 There is also an exciting possibility of direct producing the right handed neutrino and
 3 probe a class of see-saw models (Section 2.3.4). Finally, both direct search and indirect
 4 measurement can look for signals of a possible extended Higgs sector.

5 A lepton collider is an excellent place to perform precise QCD measurement, and fur-
 6 ther our understanding of the strong interaction. Possible topics, covered in Section 2.4,
 7 include measurement of α_s , jet, event shapes and their utility in probing light Yukawa
 8 couplings, are summarized in the next part of the section.

9 The CEPC can produce close to 10^{12} Z bosons. Hence, it can be a powerful B -factory
 10 and τ -factory with excellent potential. At the same time, new flavor physics may show up
 11 as rare flavor violating Z decays. Section 2.5 is an overview of such physics, and provides
 12 an estimate of the potential of the CEPC.

13 2.1 CEPC: the precision frontier

14 The discovery of a Higgs boson in 2012 by the ATLAS and CMS collaborations [1, 2] at
 15 the Large Hadron Collider (LHC) has opened a new era in particle physics. Subsequent
 16 measurements of the properties of this new particle have indicated compatibility with the
 17 predictions of the Standard Model (SM) While the SM has been remarkably successful
 18 in describing experimental phenomena, it is important to recognize that the SM is not
 19 a complete theory. In particular, the SM does not *predict* the parameters in the Higgs
 20 potential, such as the Higgs mass. The vast difference between the Planck scale and the
 21 weak scale remains a major mystery. In addition, there is not a complete understanding
 22 of the nature of the electroweak phase transition. The discovery of a spin zero Higgs
 23 boson, the first elementary particle of its kind, has only sharpened these questions, and
 24 their resolution will necessarily involve new physics beyond the SM. In this respect, the
 25 Higgs boson discovery marks the beginning of a new era of theoretical and experimental
 26 exploration.

27 The precision measurement of Higgs properties will be a critical component of any
 28 roadmap for high energy physics in the coming decades. In addition to motivating new
 29 physics beyond the SM, the Higgs provides a uniquely sensitive probe of new physics. In
 30 particular, new physics beyond the SM can lead to observable deviations in Higgs boson
 31 couplings relative to SM expectations. These deviations δ are generically of order

$$\delta = c \frac{v^2}{M_{\text{NP}}^2}, \quad (2.1)$$

32 where v and M_{NP} are the vacuum expectation value of the Higgs field and the typical
 33 mass scale of new physics, respectively. The size of the proportionality constant c is
 34 model-dependent, but it should not be much larger than $O(1)$. The current and upcoming
 35 LHC runs will measure Higgs couplings to about the 5% level [3], while direct searches
 36 at the LHC will test many new physics scenarios from a few hundreds of GeV to at least
 37 a TeV. Eq. (2.1) implies that probing new physics significantly *beyond* the LHC's reach
 38 requires measuring Higgs boson couplings with sub-percent-level accuracy. Achieving
 39 such a level of precision will require new facilities, for which a lepton collider operating
 40 as a Higgs factory is a natural candidate.

41 In this section we explore the physics potential of the CEPC, translating the potential
 42 precision of Higgs coupling measurements into implications for a variety of motivated

1 scenarios for physics beyond the SM. Projections for the precision in Higgs coupling
 2 measurements and electroweak observables attainable by the CEPC are summarized be-
 3 low. The details of the analysis underpinning these projections are presented in Section
 4 [refer to the physics potential section].

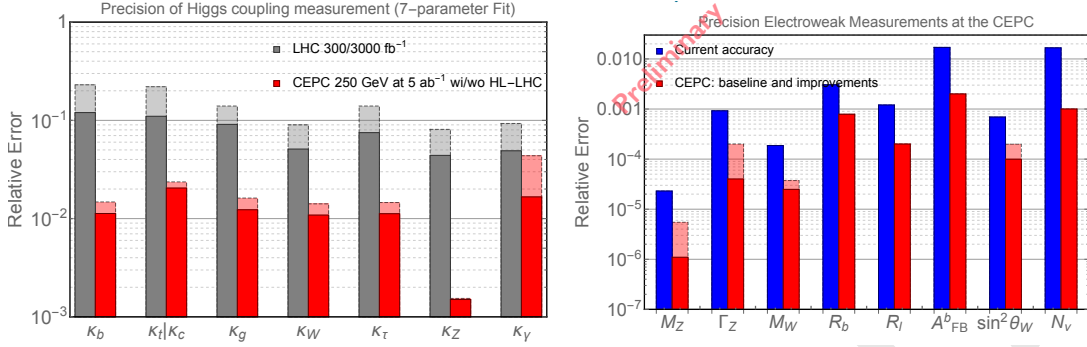

Figure 2.1: Left: Higgs coupling extraction in the κ -framework. Right: Projection for the precision of the Z -pole measurements.

5 The CEPC will operate primarily at a center-of-mass energy of $\sqrt{s} \sim 240$ GeV. The
 6 main mode of Higgs production is through $e^+e^- \rightarrow Zh$ process, and with an integrated lu-
 7 minosity of 5 ab^{-1} , over one million Higgs bosons will be produced. At CEPC, in contrast
 8 to the LHC, Higgs boson candidate events can be identified through a technique known
 9 as the recoil mass method without tagging its decay products. This allows Higgs boson
 10 production to be disentangled from Higgs decay in a model-independent way. Moreover,
 11 the cleaner environment at a lepton collider allows much better exclusive measurement of
 12 Higgs boson decay channels. All of these give CEPC impressive reach in probing Higgs
 13 boson properties. The resulting precision attainable by CEPC in measurements of Higgs
 14 couplings is shown in the left panel of Figure 2.1 in terms of the κ framework.

15 Several aspects of the Higgs precision attainable at CEPC stand out. The CEPC will
 16 be able to measure the Higgs boson coupling to the Z boson with an accuracy of 0.25%,
 17 about a factor of 10 better than the reach of the High Luminosity upgrade of the LHC
 18 (HL-LHC). Such a precise measurement gives CEPC unprecedented reach into interesting
 19 new physics scenarios which are very difficult to probe at the LHC. The CEPC also has
 20 strong capability in detecting invisible decays of the Higgs boson. For example, with
 21 5 ab^{-1} , it can improve the accuracy of the measurement of the Higgs invisible branching
 22 ratio to 0.14%. In addition, it is expected to have excellent sensitivity to exotic decay
 23 channels which are swamped by backgrounds at the LHC. It is also important to stress
 24 that an e^+e^- Higgs factory can perform *model independent* measurement of the Higgs
 25 boson width. This unique feature in turn allows for the determination of the Higgs boson
 26 couplings without assumptions about Higgs decay channels. [update with most recent
 27 higgs coupling numbers]

28 The CEPC is also designed to run at the Z pole and near the W^+W^- threshold (with
 29 about 10^7 W pairs). This enables a robust program of electroweak precision measure-
 30 ments to complement the Higgs precision program. The projected precision for a set of
 31 such observables is shown in on the right panel of Figure 2.1. In comparison with the
 32 current precision, CEPC can improve by about one order of magnitude.

33 The combination of precision Higgs and electroweak measurements at CEPC is par-
 34 ticularly powerful. This is most readily apparent in the potential for CEPC to constrain

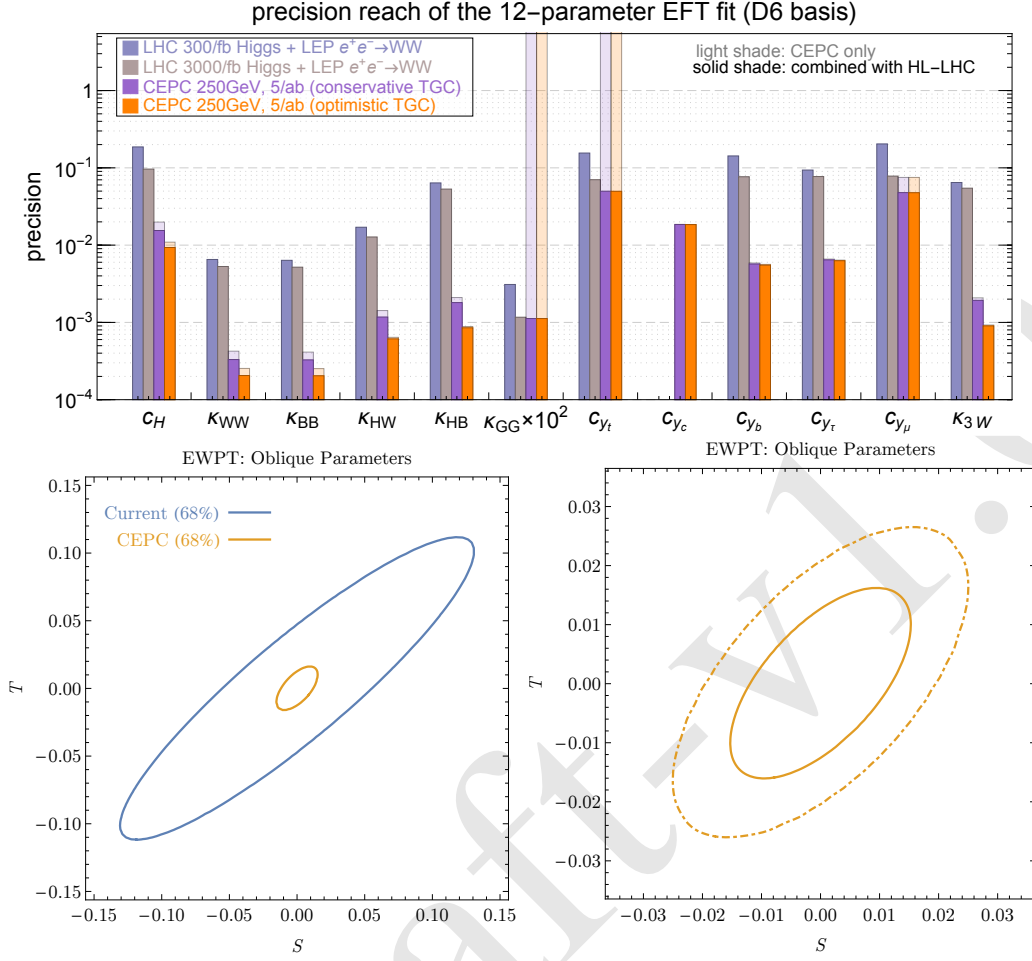

Figure 2.2: Upper panel: The reach of the Higgs measurement on the size of effective field theory operators, normalized as $c_i(\mathcal{O}_i/v^2)$. Lower panel: On the left, the CEPC limit on the oblique parameters in comparison with the current precision. On the right, 68% (dash-dot) and 95% (solid) contours from CEPC measurement.

1 departures from the Standard Model parameterized in the language of effective field theory (EFT). The reach of CEPC Higgs measurements in constraining Wilson coefficients
 2 of select dimension-6 operators in the SM EFT is shown in Figure 2.2, while the reach of
 3 CEPC electroweak precision measurements in terms of the so-called oblique parameters
 4 (likewise expressible in terms of Wilson coefficients of dimension-6 operators in the SM
 5 EFT) is shown in the lower panel of Figure 2.2. The significant improvement of CEPC
 6 relative to both current and projected LHC measurements is apparent. Later in this section,
 7 we will explore in detail the implications of the precision measurements at CEPC for
 8 important open questions of the Standard Model.

9 CEPC, running as both Higgs factory and Z-factory, will also probe interesting new
 10 physics, offer an excellent opportunity of studying flavor physics, allow precise QCD
 11 measurements. We will also elaborate on these later in this section. To set the stage, we
 12 briefly comment on the running scenarios assumed in the results presented in this section.
 13 While the plan for the Higgs factory has been fixed, the plan for the Z-factory run is
 14 still preliminary. The total number of Z s with different options ranging from 0.3×10^{12}
 15

1 (baseline) to up to 10^{12} Zs. To give an characterization of the full potential of the CEPC,
 2 we will use 10^{12} Zs (Tera Z) in our estimates.

3 2.2 Higgs and electroweak symmetry breaking

4 2.2.1 Naturalness

5 The appearance of large numerical hierarchies in fundamental theories has long been a
 6 source of discomfort, articulated in the modern era by Dirac [4] and subsequently refined
 7 in the context of quantum field theory by Wilson [5], Susskind [6], 't Hooft [7], and others.
 8 In the context of quantum field theory, dimensionless parameters of a quantum field theory
 9 are naturally expected to be $O(1)$, while the dimensionful parameters are naturally the
 10 size of the fundamental scale at which the theory is defined. An exception arises when a
 11 symmetry is manifested in the limit that a parameter of the theory is taken to zero. In this
 12 case, it is “technically natural” for some parameters to remain smaller than others, in the
 13 sense that they are protected from large quantum corrections, though even in this case one
 14 is left to find an explanation for the dynamical origin of the small parameter. This notion
 15 of naturalness has been reinforced by the widespread successes of effective field theory
 16 and diverse realizations in both particle physics and condensed matter physics.

17 Famously, all of the observed parameters of the Standard Model satisfy the naturalness
 18 criterion in some form, with the exception of the Higgs mass parameter and the strong
 19 CP angle. The naturalness of these parameters remains an open question, and in each
 20 case a natural explanation entails a significant extension of the Standard Model. Of these,
 21 the naturalness of the weak scale is perhaps the most pressing, as it is drawn into sharp
 22 relief by the discovery of an apparently elementary Higgs boson at the LHC. Evidence for
 23 a natural explanation for the value of the weak scale has yet to appear, with null results
 24 across a suite of experimental searches imperiling many preferred candidates. But the
 25 LHC is not capable of decisively deciding the naturalness of the weak scale, providing
 26 strong motivation for colliders that complement LHC sensitivity to natural new physics.

27 The oft-cited quadratically divergent radiative corrections to the Higgs mass parameter,
 28

$$\delta m_h^2 \sim \frac{3y_t^2}{8\pi^2} \Lambda^2, \quad (2.2)$$

29 are not the naturalness problem in and of themselves, but rather an indication of the prob-
 30 lem. Such divergences indicate that the Higgs mass parameter is precisely that – a param-
 31 eter – and incalculable in the Standard Model. But the robust expectation is that the Higgs
 32 mass and other parameters of the Standard Model are fully calculable in a fundamental
 33 theory. In this case, the quadratically divergent contributions to the Higgs mass parameter
 34 in the Standard Model are replaced by finite contributions dictated by the fundamental
 35 theory. The Higgs mass in terms of underlying parameters will take the form

$$m_h^2 = a\Lambda_h^2 + b\frac{3y_t^2}{8\pi^2}\Lambda_h^2 + \dots \quad (2.3)$$

36 where a, b, \dots are dimensionless constants and Λ_h is an underlying mass scale of the
 37 fundamental theory. If the Higgs mass is *natural*, the parameters a and b will be $O(1)$,
 38 up to possible manifestations of technical naturalness associated with symmetries in the
 39 underlying theory. In this case, one expects $m_h \sim \Lambda_h$, corresponding to the appearance of

1 new physics near the weak scale. Alternately, $m_h \ll \Lambda_h$ points either to *fine-tuning* among
 2 fundamental parameters, or to a correlation between ultraviolet and infrared aspects of the
 3 theory with no known counterpart in effective field theory.

4 The most promising strategy for rendering the weak scale natural in a more fundamen-
 5 tal theory is to extend the Standard Model to include additional symmetries that render
 6 the Higgs mass parameter technically natural. In four dimensions, the available symme-
 7 tries are supersymmetry and global symmetry. In the former case, the fields of the Stan-
 8 dard Model are extended into complete supersymmetric multiplets, and supersymmetry
 9 is softly broken to accommodate the non-degeneracy of Standard Model fields and their
 10 partners [8–10]. The Higgs is related to a fermionic partner, thereby rendering the Higgs
 11 mass technically natural by the same chiral symmetries that protect the fermion masses.
 12 In the latter case, the Higgs is a pseudo-Nambu-Goldstone boson (pNGB) of a sponta-
 13 neously broken global symmetry, with a mass parameter protected by the corresponding
 14 shift symmetries. The scale of global symmetry breaking in such theories must itself be
 15 rendered natural, leading to e.g. composite Higgs models [11] and little Higgs models [12]
 16 (for an excellent recent review, see [13]).

17 In both cases, these symmetries predict an abundance of new physics near the weak
 18 scale. Although this new physics may be searched for efficiently at the LHC, such searches
 19 typically leverage ancillary properties of the new physics unrelated to the naturalness of
 20 the weak scale. For example, searches for the scalar top partners predicted by supersym-
 21 metry typically leverage QCD quantum numbers of the stop and decay modes unrelated
 22 to the stop-Higgs coupling. The sensitivity of LHC searches to inessential features of the
 23 new physics makes them imperfect probes of electroweak naturalness.

24 In this respect, a Higgs factory provides the ideal context for probing natural new
 25 physics via precision Higgs couplings. The same couplings and diagrams that control the
 26 size of the Higgs mass in a natural theory generate radiative corrections to its couplings.
 27 As such, precision tests of Higgs properties directly probe natural physics in a way that is
 28 complementary to, and less subject to caveats than, direct searches at the LHC.

29 Signatures of natural new physics in precision Higgs measurements take a variety of
 30 forms. In most symmetry solutions, there are Higgs coupling deviations due to tree-level
 31 mixing with additional Higgs-like states. However, these tree-level deviations need not
 32 be the leading effect. Radiative corrections are also significant, due to both the size of
 33 Higgs couplings and the proximity of new particles to the weak scale. In theories where
 34 new physics associated with naturalness carries Standard Model quantum numbers, such
 35 as conventional supersymmetric and composite models, the most distinctive radiative cor-
 36 rections modify loop-induced Higgs couplings to gluons and photons. In addition, all
 37 symmetry solutions – whether or not they involve new states charged under the Standard
 38 Model – radiatively modify Higgs couplings through effective wavefunction renormaliza-
 39 tion of the physical Higgs scalar, an effect that may be observed in loop-level corrections
 40 to tree-level Higgs couplings.

41 Although our discussion of naturalness has focused on symmetries, they are not the only
 42 mechanism for explaining the value of the weak scale. The most notable alternative is to
 43 lower the cutoff in Eq. (2.3), the avenue realized by technicolor [6, 14] and large [15, 16]
 44 or warped [17, 18] extra dimensions. However, these solutions typically do not predict a
 45 significant mass gap between the Higgs and additional degrees of freedom, making them
 46 more susceptible to LHC null results. More recent proposals, such as relaxation of the
 47 weak scale [19], can potentially lead to $m_h \ll \Lambda_h$ without fine-tuning, and remain inter-

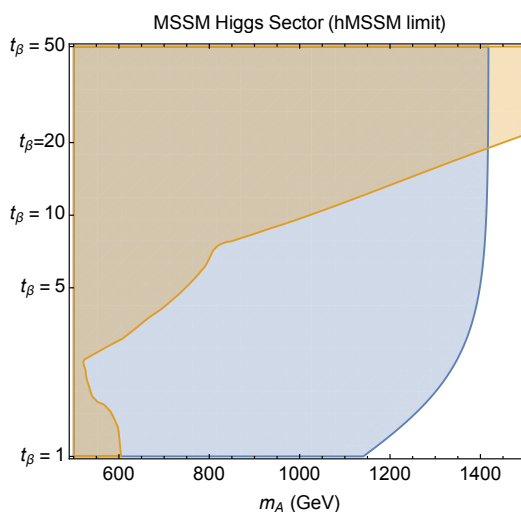

Figure 2.3: Potential coverage of the MSSM Higgs sector in the hMSSM limit [21] at CEPC is shown in blue. Sensitivity is driven largely by modifications of the Higgs coupling to bottom quarks. Projected HL-LHC coverage of the MSSM Higgs sector in the same limit due to direct searches for heavy Higgs states is shown in orange [22].

1 esting targets for exploration. Nonetheless, these alternatives still involve new particles
 2 coupling to the Higgs, and may leave their imprint on Higgs couplings or exotic decays.

3 Supersymmetry

4 Supersymmetric extensions of the Standard Model have the virtue of rendering the weak
 5 scale natural with an elementary Higgs scalar, consistent with properties observed thus
 6 far at the LHC. While searches for supersymmetric partner particles at the LHC have
 7 excluded large regions of the natural supersymmetric parameter space, significant blind
 8 spots remain that are best covered by precision Higgs coupling measurements.

9 **Tree-level modifications to Higgs properties** Supersymmetric extensions of the Standard
 10 Model necessitate more than one Higgs doublet. Mass mixing between the CP-even neu-
 11 tral Higgs scalars leads to tree-level deviations in Higgs properties. In the limit that the
 12 additional Higgs scalars are heavy and may be integrated out, this leads to dimension-
 13 six operators that shift Higgs couplings to fermions and dimension-eight operators that
 14 shift Higgs couplings to massive vectors. As a result, deviations are largest in Higgs
 15 couplings to fermions, particularly those in the down quark and lepton sectors. Percent-
 16 level CEPC sensitivity to modifications of the Higgs coupling to bottom quark enables
 17 indirect tests of the MSSM Higgs sector to the TeV scale, as illustrated in Figure 2.3.
 18 More broadly, CEPC sensitivity to tree-level effects in extended Higgs sectors such as the
 19 MSSM is studied comprehensively in [20]. However, due to the decoupling properties
 20 of the MSSM Higgs sector, heavy Higgs states may remain above the TeV scale without
 21 increasing the fine-tuning of the weak scale. In this respect, tree-level modifications to
 22 Higgs properties arising in supersymmetric theories represent a discovery opportunity but
 23 not an irreducible constraint.

24 **Loop-level modifications to Higgs properties** The plethora of new partner particles pre-
 25 dicted by supersymmetric extensions of the Standard Model leads to a wealth of loop-

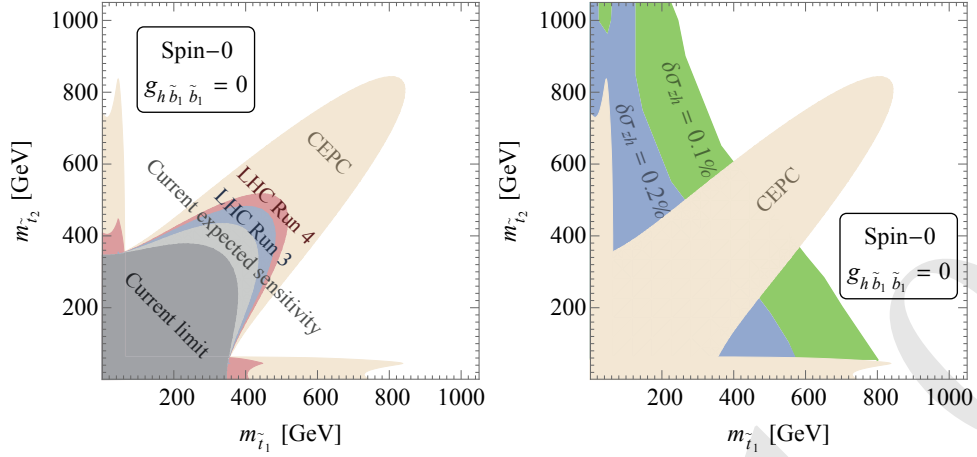

Figure 2.4: **Left:** LHC and CEPC precision Higgs constraints in the $m_{\tilde{t}_1} - m_{\tilde{t}_2}$ plane from Higgs couplings to gluons and photons. **Right:** Coverage of blind spots including precision measurement of the Zh cross section. Figures adapted from [26].

1 level contributions to Higgs couplings. These contributions are typically largest in the
 2 stop sector, due to the large coupling to the Higgs required by supersymmetry, but may
 3 be significant for any of the partners of third-generation fermions. The most distinctive
 4 consequences are modifications to the loop-level Standard Model couplings of the Higgs
 5 to gluons and photons, though radiative corrections to tree-level couplings arise as well
 6 and may be used to cover blind spots arising in the loop-level couplings. The potential for
 7 CEPC to probe a suite of loop-level corrections to Higgs and electroweak observables in
 8 supersymmetric models is comprehensively studied in [23].

9 For simplicity, here we will focus on the loop-level consequences in the stop sector,
 10 corresponding to the scalar partners of both the right-handed and left-handed top quarks.
 11 In the limit that the stops are significantly heavier than the Higgs, the correction to gluons
 12 and photons is proportional to

$$\frac{1}{4} \left(\frac{m_t^2}{m_{\tilde{t}_1}^2} + \frac{m_t^2}{m_{\tilde{t}_2}^2} - \frac{m_t^2 X_t^2}{m_{\tilde{t}_1}^2 m_{\tilde{t}_2}^2} \right) \quad (2.4)$$

13 where $m_{\tilde{t}_1}, m_{\tilde{t}_2}$ are the stop mass eigenstates and $X_t = A_t - \mu \cot \beta$ is the off-diagonal
 14 mixing parameter in the stop mass matrix. The mixing parameter is bounded from above
 15 by the avoidance of tachyonic stops, and from below by precision measurements of the
 16 Higgs coupling to gluons and photons. A robust bound may be placed on the stop sector
 17 whenever the minimum value exceeds the maximum value [24]. The strongest constraints
 18 arise in the degenerate limit when $m_{\tilde{t}_1} = m_{\tilde{t}_2}$, in which case CEPC is capable of probing
 19 stop masses close to the TeV scale; this is illustrated in the left panel of Figure 2.4.
 20 However, the modification of Higgs couplings is highly sensitive to the mixing in the stop
 21 sector, and blind spots arise when the mixing leads to vanishing deviations in the Higgs
 22 coupling to gluons and photons [23, 25]. However, as illustrated in the right panel of
 23 Figure 2.4, these blind spots may be covered by precision measurements of the Zh cross
 24 section, which is sensitive to loop-level corrections to the tree-level hZZ coupling that
 25 are generically nonzero in the gluon/photon blind spot [25].

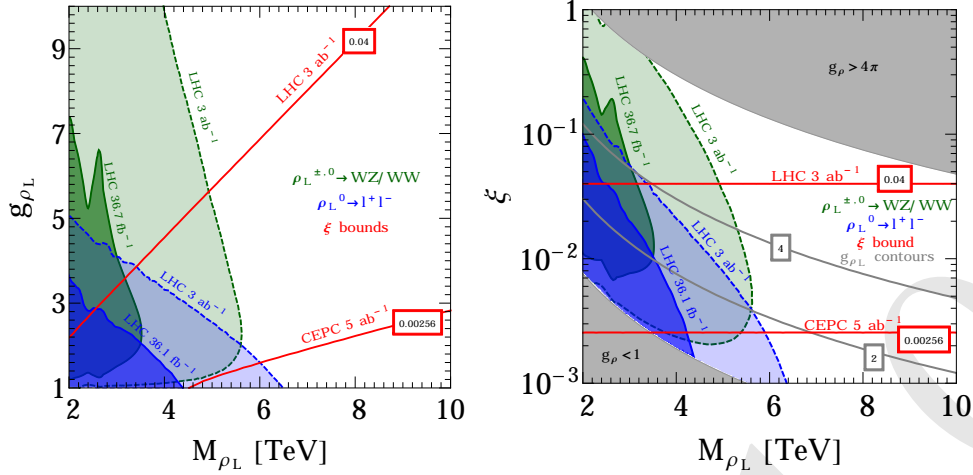

Figure 2.5: Potential coverage of composite-type global symmetry models in terms of resonance mass m_ρ and coupling parameter g_{ρ_L} (left panel) or mixing parameter $\xi \equiv v^2/f^2$ (right panel) via direct searches at the LHC (blue and green shaded regions) and precision Higgs measurement constraints (red lines).

1 Global symmetry

2 Global symmetry approaches to the weak scale cover a vast array of specific models and
 3 UV completions, but share the common features of an approximately elementary Standard
 4 Model-like Higgs mixing with heavier resonances and further influenced by the presence
 5 of light fermionic excitations.

6 **Tree level** In global symmetry solutions, the Higgs is a pNGB of a spontaneously broken
 7 global symmetry. This invariably implies tree-level corrections, which can be interpreted
 8 as arising from mixing between the Standard Model-like Higgs and heavy states asso-
 9 ciated with the spontaneously broken global symmetry. This mixing is typically propor-
 10 tional to v^2/f^2 , where f is the decay constant associated with the broken global symmetry
 11 (see e.g. [27] for a comprehensive parameterization), although precise corrections may
 12 vary between Higgs couplings to fermions and gauge bosons depending on the model.
 13 As shown in Figure 2.5, the precision attainable at CEPC probes this mixing to better
 14 than one part in one hundred, translating to an energy reach of several TeV. In the sim-
 15 plest composite realizations of global symmetries, bounds on v^2/f^2 translate directly into
 16 lower bounds on the tuning of the electroweak scale, but this tuning may be avoided in
 17 Little Higgs models and related constructions. The complementarity between precision
 18 measurements of Higgs couplings and direct searches at future colliders in probing global
 19 symmetry approaches to the hierarchy problem is explored in detail in e.g. [28].

20 **Loop level** Global symmetry approaches to naturalness likewise feature a plethora of
 21 new states near the weak scale, albeit with the same statistics as their Standard Model
 22 counterparts. While corrections to Higgs couplings from loops of these new particles are
 23 typically sub-dominant compared to tree-level corrections, they provide a more immutable
 24 test of naturalness. As with supersymmetry, the largest corrections are typically due to
 25 the fermionic top partner sector, due to the large coupling of these partners to the Higgs
 26 and their proximity to the weak scale. As such partners typically carry Standard Model

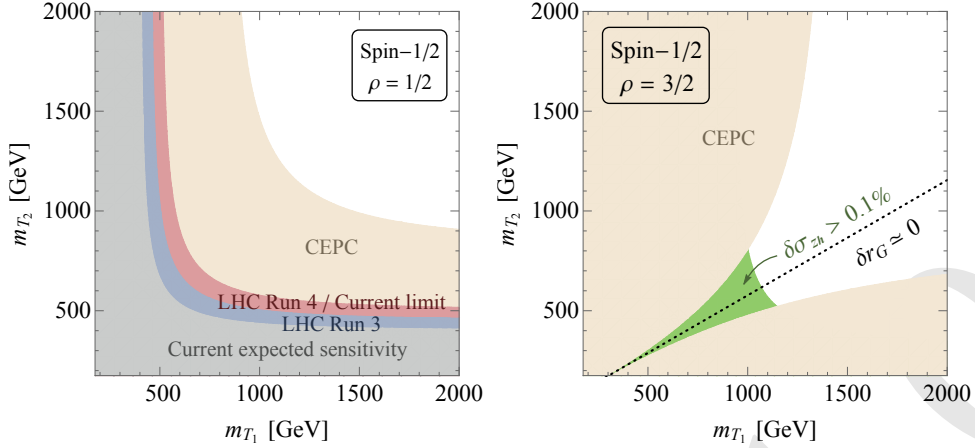

Figure 2.6: **Left:** LHC and CEPC precision Higgs constraints in the $m_{T_1} - m_{T_2}$ plane from Higgs couplings to gluons and photons assuming equal couplings. **Right:** Coverage of blind spots including precision measurement of the Zh cross section. Figures adapted from [26].

1 quantum numbers, the most striking corrections are to the loop-level couplings of the
2 Higgs to gluons and photons.

3 For the sake of definiteness, consider a theory involving two top partners T_1, T_2 whose
4 couplings are dictated by the global symmetry protecting the Higgs mass. In this case
5 corrections to the Higgs coupling to gluons and photons are proportional to [26]

$$- \left(\rho \frac{m_t^2}{m_{T_1}^2} + (1 - \rho) \frac{m_t^2}{m_{T_2}^2} \right) \quad (2.5)$$

6 where ρ parameterizes the fraction of the quadratic divergence cancellation coming from
7 the T_1 field, which is directly reflected in the modification of Higgs couplings. In the
8 case of equal couplings, CEPC is capable of probing fermionic top partners above the
9 TeV scale, as shown in the left panel of Figure 2.6. Note that the existence of more
10 than one fermionic top partner allows for the possibility of a blind spot to arise when
11 $\rho > 1$, which may be constrained by radiative corrections to the Zh cross section (shown
12 in the left panel of Figure 2.6) in analogy with the stop blind spot in supersymmetry.
13 A comprehensive exploration of CEPC’s potential to constrain radiative corrections to
14 Higgs couplings arising in global symmetry solutions to the hierarchy problem may be
15 found in [26].

16 Neutral naturalness

17 While it is entirely possible that the naturalness of the weak scale is explained by con-
18 ventional symmetries that have thus far evaded LHC detection, LHC null results may
19 indicate that the weak scale is stabilized by less conventional symmetries that do not lead
20 to partner particles carrying Standard Model quantum numbers. This form of “neutral
21 naturalness” [29] can occur, for example, when only discrete symmetries are operative
22 at the weak scale. To date both opposite-statistics and same-statistics examples of neu-
23 tral naturalness have been constructed. The former case is exemplified by Folded Su-
24 persymmetry [30], which features new partner particles carrying electroweak quantum
25 numbers but no irreducible tree-level corrections. The latter case is exemplified by the
26 Twin Higgs [31], which features new partner particles entirely neutral under the Standard

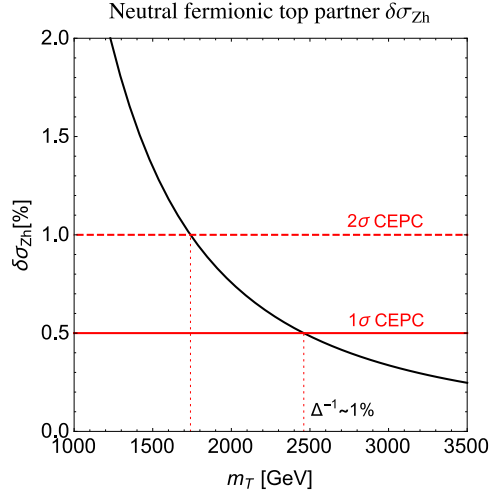

Figure 2.7: CEPC reach in the mass scale of neutral fermionic top partners due to tree-level mixing corrections to σ_{Zh} .

1 Model, as well as significant tree-level Higgs coupling deviations. Examples also exist of
 2 theories with entirely neutral scalar top partners [32] and electroweak-charged fermionic
 3 top partners [33], both of which share the tree-level modifications to Higgs couplings of
 4 the Twin Higgs.

5 The primary phenomenological consequences of neutral naturalness are (1) a signifi-
 6 cant weakening of direct search limits due to the paucity of states charged under the Stan-
 7 dard Model, and (2) the reduction of loop-level corrections to loop-level Higgs couplings.
 8 However, these models still lead to distinctive patterns of Higgs coupling deviations that
 9 may be first revealed at a Higgs factory.

10 **Tree level** Many theories of neutral naturalness, most notably the Twin Higgs [31], fea-
 11 ture significant tree-level mixing between the Standard Model-like Higgs and an addi-
 12 tional CP even scalar state. Much as with conventional global symmetries, this leads to
 13 $O(v^2/f^2)$ deviations in Higgs couplings. In contrast to conventional global symmetries,
 14 however, these corrections are typically universal in the sense that they are the same for
 15 Higgs couplings to both vectors and fermions. Bounds on v^2/f^2 may be translated di-
 16 rectly into bounds on the mass of the twin top partner, as shown in Figure 2.7. In such
 17 cases, CEPC can probe multi-TeV scales and test the efficacy of neutral naturalness down
 18 to the percent level.

19 **Loop level** While all models of neutral naturalness feature loop-level corrections to
 20 Higgs properties, they are the leading effect in many opposite-statistics models such as
 21 folded supersymmetry. New partner particles in these models still carry electroweak quan-
 22 tum numbers, leading to loop-level deviations in the Higgs coupling to photons, as shown
 23 in Figure 2.8. This allows CEPC to place constraints on the mass scale of folded partner
 24 particles in the hundreds of GeV, probing tuning of the weak scale to the 20% level in
 25 these theories.

26 It is also possible that the weak scale is stabilized by scalar top partners entirely neutral
 27 under the Standard Model without accompanying tree-level Higgs coupling deviations. In
 28 this case, all of the distinctive direct search channels and corrections to loop-level Higgs

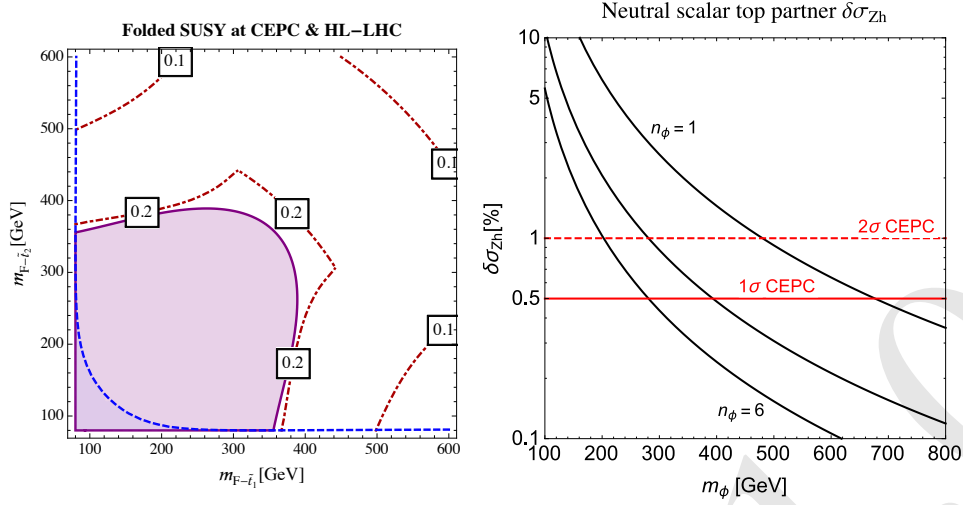

Figure 2.8: **Left:** CEPC reach for color-neutral folded stops in Folded SUSY from Higgs couplings to photons, from [23]. **Right:** CEPC reach in the mass scale of neutral scalar top partners due to loop-level corrections to σ_{Zh} , adapted from [34].

1 couplings are absent. However, a precision measurement of the Zh cross section is still
 2 sensitive to the wavefunction renormalization of the physical Higgs scalar induced by
 3 loops of the scalar top partners [34]. In general, n_ϕ scalars ϕ_i coupling via the Higgs
 4 portal interaction $\sum_i \lambda_\phi |H|^2 |\phi_i|^2$ leads to a correction to the Zh cross section of the form
 5

$$\delta\sigma_{Zh} = \frac{n_\phi |\lambda_\phi|^2 v^2}{8\pi^2 m_h^2} \left[1 + \frac{1}{4\sqrt{\tau(\tau-1)}} \log \left(\frac{1-2\tau-2\sqrt{\tau(\tau-1)}}{1-2\tau+2\sqrt{\tau(\tau-1)}} \right) \right] \quad (2.6)$$

6 where $\tau = m_h^2/4m_\phi^2$. This leads to the sensitivity shown in Figure 2.8, for which CEPC
 7 is able to place constraints in the hundreds of GeV on a scenario that is otherwise largely
 8 untestable at colliders.

9 Other solutions

10 Symmetries are not the only mechanism for explaining the origin of the weak scale,
 11 though other solutions may not be manifestly natural in the same way. However, even
 12 non-symmetry explanations for the value of the weak scale (excepting anthropic ones)
 13 generically entail some degree of coupling between new degrees of freedom and the Higgs
 14 itself. This typically leads to deviations in Higgs couplings, new exotic decay modes of
 15 the Higgs, or a combination thereof.

16 A compelling example of non-symmetry solutions is the relaxion [19], in which the
 17 value of the weak scale is set by the evolution of an axion-like particle across its potential
 18 in the early universe. The relaxion necessarily couples to the Higgs boson in order for its
 19 evolution to influence the Higgs mass. This leads to a variety of signatures that may be
 20 tested via precision Higgs measurements [35, 36].

21 The most promising signature is that of new exotic Higgs decays, most notably into the
 22 relaxion itself. This signature arises in most relaxion models as a generic consequence
 23 of the backreaction of electroweak symmetry breaking onto the relaxion potential. The
 24 mixing angle between the Higgs and relaxion in these scenarios is parametrically of order

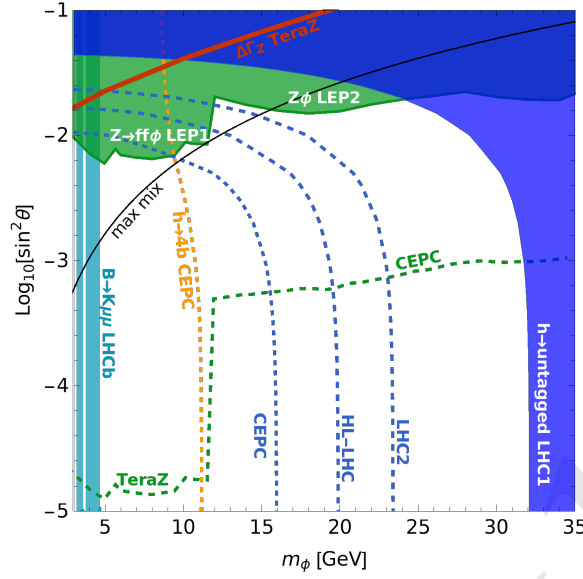

Figure 2.9: Constraints on the relaxion mass m_ϕ and relaxion-Higgs mixing angle $\sin\theta$ from the non-Standard Model decay of the Higgs into relaxion pairs, adapted from [35]. Shaded regions indicate current exclusions from LEP and the LHC. Dashed blue lines indicate the reach of CEPC and future operation of the LHC in searches for untagged non-Standard Model decays of the Higgs, while the orange dashed line indicates the reach of CEPC in searches for $h \rightarrow \phi\phi \rightarrow 4b$. The green dashed line indicates the reach of CEPC's Z -pole run in searches for $e^+e^- \rightarrow Z\phi$.

1

$$\sin\theta \approx \frac{\Lambda_{\text{br}}^4}{vf m_h^2} \quad (2.7)$$

2 where Λ_{br} is the confinement scale inducing a potential for the relaxion (identifiable with
 3 Λ_{QCD} in the most minimal models) and f is the relaxion decay constant. This leads to
 4 the decay of the Higgs into pairs of relaxions ϕ , which in turn decay back into Standard
 5 Model states via Higg-relaxion mixing.

6 The CEPC can significantly constrain these scenarios through both direct searches for
 7 processes such as $h \rightarrow \phi\phi \rightarrow 4b$ and indirect limits on exotic Higgs decays coming from
 8 precision Higgs measurements, as shown in Figure 2.9. This exemplifies the considerable
 9 power of CEPC in identifying natural explanations for the weak scale, even in the absence
 10 of additional symmetries, by virtue of its broad sensitivity to new particles interacting
 11 with the Higgs.

12 2.2.2 Electroweak phase transition

13 The discovery of the Higgs boson marks the culmination of a decades-long research pro-
 14 gram to understand the source of electroweak symmetry breaking (EWSB). We have
 15 known since the mid-20th century that this symmetry is not realized in nature and that the
 16 weak gauge bosons are massive. Now measurements at the Large Hadron Collider (LHC)
 17 have provided overwhelming evidence that EWSB results from the recently-discovered
 18 Higgs. With the Higgs boson discovery we have learned *why* the electroweak symmetry
 19 is broken in nature, but we still do not understand *how* it is broken dynamically — this is
 20 the question of the *electroweak phase transition*.

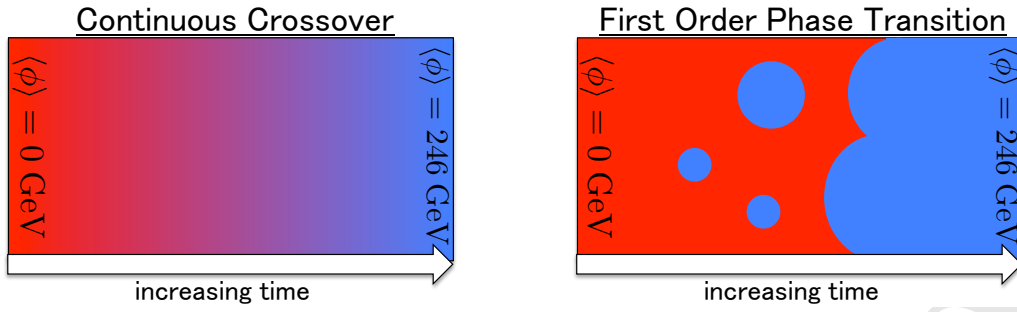

Figure 2.10: An illustration of a continuous crossover (left) and a first order phase transition (right).

1 The nature of the electroweak phase transition (EWPT) is controlled by the properties
 2 and interactions of the Higgs boson. For instance the Higgs mass sets the temperature
 3 scale of the phase transition to be roughly $T \sim m_h \simeq 125 \text{ GeV}$. The more detailed and
 4 interesting features of the phase transition depend also upon the interactions of the Higgs
 5 boson with itself, with other Standard Model particles, and with possible new physics.
 6 The nature of these interactions will not be determined very precisely at the LHC, where
 7 we have only just begun to study the Higgs. Rather, if we want to understand the nature
 8 of the electroweak phase transition, we require precision measurements of Higgs physics
 9 at a dedicated Higgs factory experiment like CEPC.

10 **First order phase transition or continuous crossover?**

11 Despite years of careful study at the LHC, we still have such a poor understanding of the
 12 Higgs that it is impossible to determine even the *order of the electroweak phase transition*.
 13 In general, these two scenarios are used to classify symmetry-breaking phase transitions:

- 14 ▪ A *first order phase transition* proceeds through the nucleation of *bubbles* that grow,
 15 coalesce, and eventually fill the system.
- 16 ▪ By contrast, a *continuous crossover* occurs smoothly throughout the system.

17 See also Figure 2.10. If the phase transition is determined to be first order, there would be
 18 profound implications for early-universe cosmology and the origin of the matter-antimatter
 19 asymmetry. Moreover, determining the order of the EWPT is simply the first step in a
 20 much richer research program that deals with other aspects of the phase transition includ-
 21 ing its latent heat, bubble wall velocity, and plasma viscosity.

22 **The Higgs potential**

23 The order of the EWPT is intimately connected to the shape of the *Higgs potential energy*
 24 *function*. For each value of the Higgs field, ϕ , there is an associated potential energy
 25 density, $V(\phi)$. During the electroweak phase transition, the Higgs field passes from $\phi = 0$
 26 where the electroweak symmetry is unbroken to $\phi = v \simeq 246 \text{ GeV}$ where the electroweak
 27 symmetry is broken and the weak gauge bosons are massive. Thus the order of the phase
 28 transition is largely determined by the shape of $V(\phi)$ in the region $0 < \phi < v$.

29 For instance, if the Higgs potential has a barrier separating $\phi = 0$ from $\phi = v$, then
 30 electroweak symmetry breaking is accomplished through a first order phase transition with
 31 the associated bubble nucleation that we discussed above. If there is no barrier in $V(\phi)$,

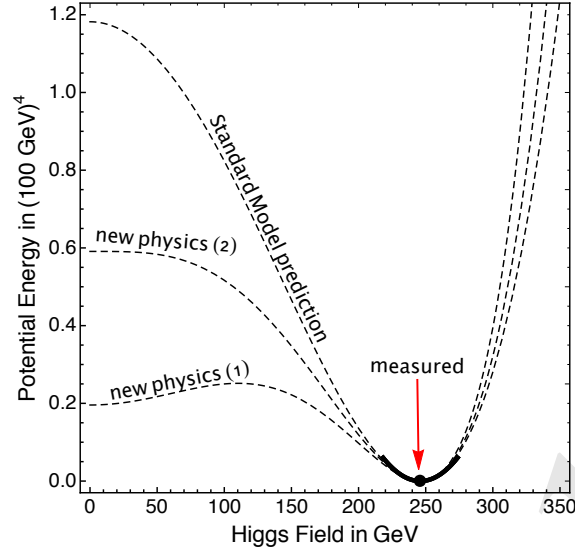

Figure 2.11: The Higgs potential energy function. All we know about the shape of the Higgs potential is the local curvature at its minimum. These observations are consistent with the Standard Model, but they are also consistent with models containing new physics that can dramatically change the nature of the electroweak phase transition.

1 the transition may be either first order or a crossover depending on the structure of the
 2 *thermal effective potential*, $V_{\text{eff}}(\phi, T)$.

3 Currently we know almost nothing about the shape of the Higgs potential. This situation
 4 is illustrated in Figure 2.11 and the following discussion. When we make measurements
 5 of the Higgs boson in the laboratory, we only probe small fluctuations of the potential
 6 around $\phi = v$. By measuring the strength of the weak interactions, $G_F = (\sqrt{2}v^2)^{-1} \simeq$
 7 $1 \times 10^{-5} \text{ GeV}^{-2}$, we learn that the Higgs potential has a local minimum at $v \simeq 246 \text{ GeV}$.
 8 By measuring the Higgs boson's mass, we learn that the local curvature of the potential at
 9 its minimum is $(d^2V/d\phi^2)|_{\phi=v} = m_h^2 \simeq (125 \text{ GeV})^2$. This is the extent of what we know
 10 today about the Higgs potential. Even the third derivative, which is related to the Higgs
 11 boson's cubic self-coupling, is completely undetermined!

Measurements of the Higgs boson thus far are consistent with the predictions of the
 Standard Model of particle physics. The Standard Model asserts that the Higgs potential
 has the form

$$V(\phi) = \frac{1}{2}\mu^2\phi^2 + \frac{1}{4}\lambda\phi^4, \quad (2.8)$$

12 which only depends on the two parameters μ^2 and λ . Taking $\lambda > 0$ and $\mu^2 < 0$ induces a
 13 vacuum expectation value (VEV) for the Higgs field and triggers electroweak symmetry
 14 breaking. At the minimum of the potential $v = \sqrt{-\mu^2/\lambda}$ gives the Higgs field VEV and
 15 $m_h^2 = -2\mu^2$ gives the Higgs boson's mass. Thus, having measured both $v \simeq 246 \text{ GeV}$
 16 and $m_h \simeq 125 \text{ GeV}$ in the laboratory, the Standard Model completely predicts the shape
 17 of the Higgs potential. For these values of the Higgs mass and VEV, the electroweak phase
 18 transition is expected to proceed via a continuous crossover in the absence of additional
 19 physics beyond the Standard Model.

However the presence of new physics can dramatically change the shape of the Higgs
 potential without disrupting the measurements of v and m_h . For example, a simple gener-

alization of Eq. (2.8) is to include a sextic term and write the Higgs potential as [37–39]

$$V(\phi) = \frac{1}{2}\mu^2\phi^2 + \frac{1}{4}\lambda\phi^4 + \frac{1}{8\Lambda^2}\phi^6. \quad (2.9)$$

A potential of this form arises if new, heavy particles are coupled to the Higgs boson, and then Λ is related to the mass scale of the new particles. This potential has enough structure to support two local minima with a barrier between, which we see in Figure 2.11 for the curve labeled “new physics (1).” The nature of the electroweak phase transition in this model is expected to be very different from the Standard Model due to the barrier [40–42]. Alternatively the new physics can manifest through a non-analytic term in the Higgs potential, such as the one proposed by Coleman and Weinberg [43],

$$V(\phi) = \frac{1}{4}\lambda\phi^4 \log \frac{\phi^2}{\Lambda^2}. \quad (2.10)$$

1 Such a potential arises when new physics is coupled to the Higgs and leads to a strong
2 running in the Higgs quartic self-coupling [44]. As shown by the curve labeled “new
3 physics (2)” in Figure 2.11, this potential is very flat near the origin allowing thermal
4 corrections to induce a barrier and thus a first order phase transition.

5 Precision measurements of the Higgs boson’s interactions with itself and other particles
6 will probe the shape of the potential energy function and thereby provide much-needed
7 experimental input to test the order of the electroweak phase transition.

8 **Cosmological implications**

9 Since we cannot reproduce the high-temperature conditions of the electroweak phase tran-
10 sition in the laboratory, the question of the EWPT has the most relevance for studies of
11 the early universe. Most cosmologists expect that a thermal EWPT occurred soon after
12 the Big Bang when the universe was filled with a very hot plasma. If the early universe
13 EWPT was first order, it may have left behind interesting cosmological relics that could
14 be accessible to observations today.

15 **Gravitational Waves.** During a first order electroweak phase transition, gravitational waves
16 are produced from the collisions of bubbles, the decay of magnetohydrodynamic turbu-
17 lence, and the damping of sound waves [45]. Today these gravitational waves would look
18 like a stochastic and isotropic “noise” from all directions on the sky. As we see in Fig-
19 ure 2.12 the predicted gravitational wave spectrum falls within reach of future space-based
20 interferometer experiments, including LISA, DECIGO, BBO, Taiji, and TianQin. The de-
21 tection of these gravitational waves would provide direct evidence that the cosmological
22 EWPT was a first-order one, but a future collider like CEPC is required to uncover the
23 new physics that explains *why* the EWPT is first order.

Matter-Antimatter Asymmetry. A first order cosmological EWPT provides the right envi-
ronment to explain the Universe’s excess of matter over antimatter through the mechanism
of *electroweak baryogenesis* [46]. This mechanism uses the fact that baryon number is
violated in the Standard Model through reactions mediated by the electroweak sphaleron.
Before the cosmological EWPT, the sphaleron efficiently converts matter into antimatter,
but during the electroweak phase transition the sphaleron-mediated reactions are shut off.
If this shutoff is sufficiently abrupt, then an excess of matter over antimatter can be gener-
ated. This requires that the electroweak phase transition is *strongly first order* in the sense

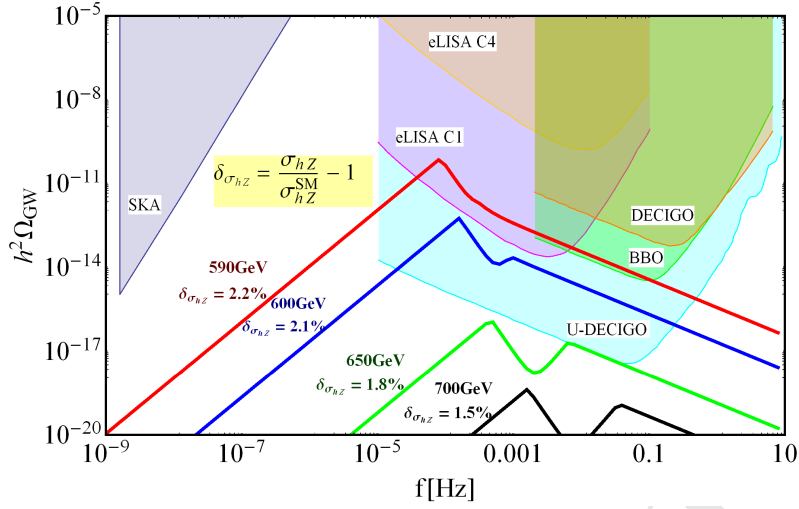

Figure 2.12: The spectrum of gravitational waves generated during a first order electroweak phase transition for the model described in Eq. (2.9). Colored curves show the predicted spectrum for different models as the scale of new physics, Λ , is varied. The figure is reproduced from Ref. [42].

that

$$\frac{v(T_{\text{pt}})}{T_{\text{pt}}} \gtrsim 1.0 \quad (\text{“strongly first order” electroweak phase transition}) \quad (2.11)$$

1 where $v(T_{\text{pt}})$ is the value of the Higgs field inside of the bubbles during the phase transition
 2 at temperature T_{pt} .

3 Electroweak baryogenesis is not viable in the Standard Model, because the electroweak
 4 phase transition is a continuous crossover, $v(T_{\text{pt}}) = 0$, and thus the observed excess
 5 of matter over antimatter is an irrefutable motivation for physics beyond the Standard
 6 Model. In general the new physics can take many forms, but in the context of electroweak
 7 baryogenesis, it is clear that the new physics must couple to the Higgs boson so that
 8 the sphaleron-suppression condition in Eq. (2.11) is satisfied. Therefore this condition
 9 directly quantifies the required departure from Standard Model physics.

10 New physics and the electroweak phase transition

11 The Standard Model predicts that the EWPT is a continuous crossover, but we have seen
 12 in the discussion of Figure 2.11 that even minimal extensions of the Standard Model
 13 can drastically change the predictions for electroweak symmetry breaking. Thus for any
 14 model with new physics coupled to the Higgs, it is necessary to ask: What is the nature of
 15 the electroweak phase transition?

16 In the years before the LHC started running, much of the work was focused on the
 17 *light stop scenario* of the Minimal Supersymmetric Standard Model (MSSM) [47, 48].
 18 Early LHC data determined that this scenario is ruled out [49, 50], because the light stops,
 19 which are colored and charged particles with spin-0, should have been easy to produce and
 20 detect at the LHC. However, if the new scalar particles were not charged or colored, the
 21 electroweak phase transition could still be first order while evading collider constraints; to
 22 leading order, the electroweak phase transition only cares about couplings with the Higgs,
 23 not quantum numbers [51]. Therefore in order to assess the unique power of CEPC to test

1 new physics that leads to a first order electroweak phase transition, it is useful to consider
 2 models with uncharged and uncolored particles, which are very difficult to probe at the
 3 LHC.

A viable model with a first order EWPT is found in even the most minimal extension of the Standard Model with a real, scalar singlet field S [52–54]. The relevant Lagrangian is written as

$$\begin{aligned} \mathcal{L} = & (D_\mu H)^\dagger (D^\mu H) + \frac{1}{2}(\partial_\mu S)(\partial^\mu S) - \mu_H^2 H^\dagger H - \lambda_H (H^\dagger H)^2 \\ & - \frac{\mu_S^2}{2} S^2 - \frac{a_S}{3} S^3 - \frac{\lambda_S}{4} S^4 - \lambda_{HS} H^\dagger H S^2 - 2a_{HS} H^\dagger H S \end{aligned} \quad (2.12)$$

4 where $H(x)$ denotes the Higgs doublet field. The last two operators in Eq. (2.12) cor-
 5 respond to the so-called Higgs portal interactions. The Higgs field acquires a vacuum
 6 expectation value, $\langle H \rangle = (0, v/\sqrt{2})$ that breaks the electroweak symmetry. In general
 7 the singlet field may acquire a vacuum expectation value, $\langle S \rangle = v_S$, and it can mix with
 8 the Higgs boson, which is parametrized by an angle θ . The spectrum of this theory con-
 9 tains two scalars with masses $m_h \simeq 125$ GeV and m_S .

10 It is also interesting to consider the model that is obtained by imposing a \mathbb{Z}_2 symmetry
 11 on Eq. (2.12). This symmetry transformation, $S(x) \rightarrow -S(x)$, enforces $a_{HS} = a_S = 0$,
 12 and it is conventional to also assume that $v_S = 0$.

The singlet extension of the Standard Model allows for a first order electroweak phase transition in a variety of ways [51]. If the singlet particle is heavy, $m_S \gg m_h$, then it can be integrated out of the theory generating an effective potential for the Higgs field. In the regime where the a_S and λ_S terms are negligible and $\mu_S^2 \gg \lambda_{HS} v^2$, the Higgs potential takes the form

$$V(\phi) = \frac{1}{2} \mu_H^2 \phi^2 + \frac{1}{4} \left(\lambda_H - \frac{2a_{HS}^2}{\mu_S^2} \right) \phi^4 + \frac{\lambda_{HS} a_{HS}^2}{2m_S^4} \phi^6, \quad (2.13)$$

13 which has the same structure as the one that we encountered in Eq. (2.9). The two poten-
 14 tials are matched by taking $\Lambda^2 = m_S^4 / (4\lambda_{HS} a_{HS}^2)$. For smaller Λ the shape of the Higgs
 15 potential begins to deviate more from the Standard Model prediction, and the phase tran-
 16 sition becomes first order. This example illustrates the intuition that models with a first
 17 order electroweak phase transition require new, light particles with a large coupling to the
 18 Higgs boson. If the singlet particle is so light that we are not justified to integrate it out
 19 ($m_S \sim m_h$) the analysis above is inapplicable, but the phase transition can still be made
 20 first order due to the presence of large loop corrections to the Higgs potential [44], large
 21 thermal corrections, and/or a multi-step phase transition [55]. Some of these scenarios are
 22 illustrated in the left panel of Figure 2.13 for the \mathbb{Z}_2 -symmetric singlet extension.

23 In general the presence of new particles coupled to the Higgs boson modifies how
 24 strongly the Higgs couples to itself and to the other Standard Model particles. It is pre-
 25 cisely the goal of Higgs factory experiments, like CEPC, to measure these couplings with
 26 high precision. Therefore, if the electroweak phase transition is first order, we expect that
 27 the measurements of these couplings must deviate from their Standard Model predictions.

The coupling that will be measured most precisely at CEPC and future lepton colliders is the Higgs- Z - Z coupling. We can parametrize deviations in this parameter away from

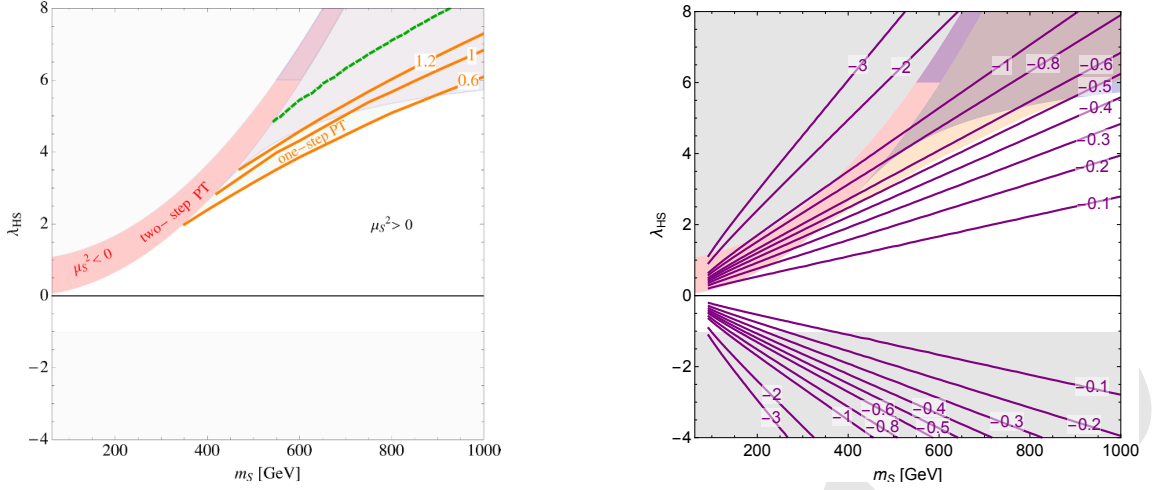

Figure 2.13: Parameter space of the real scalar singlet model with \mathbb{Z}_2 symmetry. **Left:** Regions of parameter space that lead to a first order electroweak phase transition that proceeds in one or two steps. The orange curves show the strength of the electroweak phase transition, $v(T_c)/T_c$, in the one-step region. **Right:** Purple curves show the fractional change to the Zh production cross section relative to the SM prediction in percent; these values are $2 \delta g_{hZZ}$ using the notation in the text (2.14). The figures are taken from Ref. [56]. (Also see Ref. [57].)

the Standard Model prediction with the variable

$$\delta g_{hZZ} \equiv \frac{1}{2} \left(\frac{\sigma(e^+e^- \rightarrow hZ)}{\sigma_{\text{SM}}(e^+e^- \rightarrow hZ)} - 1 \right) \Big|_{s=(250 \text{ GeV})^2} = \frac{g_{hZZ}}{g_{hZZ,\text{SM}}} - 1 \Big|_{s=(250 \text{ GeV})^2}. \quad (2.14)$$

In the singlet extension model, the strength of the hZZ coupling is suppressed compared to the SM prediction. The leading-order suppression arises from the Higgs-singlet mixing, and the sub-leading effect arises from Higgs wavefunction renormalization [34] and the Higgs triple self-coupling [58]. Combining these effects, the fractional suppression is written as [56, 59]

$$\delta g_{hZZ} = (\cos \theta - 1) - 2 \frac{|a_{HS} + \lambda_{HS} v_S|^2}{16\pi^2} I_B(m_h^2; m_h^2, m_S^2) - \frac{|\lambda_{HS}|^2 v^2}{16\pi^2} I_B(m_h^2; m_S^2, m_S^2) + 0.006 \left(\frac{\lambda_3}{\lambda_{3,\text{SM}}} - 1 \right) \quad (2.15)$$

where θ is the Higgs-singlet mixing angle, and I_B is a loop function. The Higgs triple self-coupling λ_3 also deviates from the Standard Model prediction due to the Higgs-singlet mixing. Then the self-coupling is predicted to be [60]

$$\lambda_3 = (6\lambda_{Hv}) \cos^3 \theta + (6a_{HS} + 6\lambda_{HS} v_S) \sin \theta \cos^2 \theta + (6\lambda_{HS} v) \sin^2 \theta \cos \theta + (2a_S + 6\lambda_S v_S) \sin^3 \theta. \quad (2.16)$$

In the Standard Model we have $\lambda_3 = \lambda_{3,\text{SM}} \equiv 3m_h^2/v \simeq 191 \text{ GeV}$. If the singlet is light, $m_S < m_h/2$, then the Higgs boson acquires an exotic decay channel, $h \rightarrow SS$, which

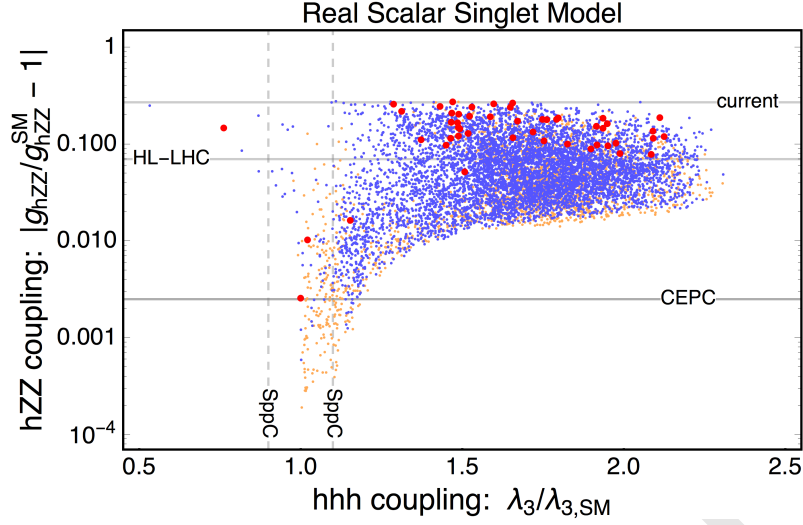

Figure 2.14: Collider observables in the real scalar singlet model. Points in theory space with a first order phase transition are shown in orange, points with a strongly first order phase transition are shown in blue, and points with a strongly first order phase transition that also produces detectable gravitational waves are shown in red. The figure is reproduced from Ref. [59].

may be invisible depending on the stability of S . The rate for this decay is

$$\Gamma(h \rightarrow SS) = \frac{\lambda_{211}^2}{32\pi m_h} \sqrt{1 - \frac{4m_S^2}{m_h^2}} \quad (2.17)$$

where

$$\lambda_{211} = (2a_{HS} + 2\lambda_{HS}v_S) \cos^3 \theta + (4\lambda_{HS}v - 6\lambda_{HV}) \sin \theta \cos^2 \theta + (6\lambda_S v_S + 2a_S - 4\lambda_{HS}v_S - 4a_{HS}) \sin^2 \theta \cos \theta + (-2\lambda_{HS}v) \sin^3 \theta \quad (2.18)$$

1 is the effective tri-linear coupling of the mass eigenstates. Measurements of the Higgs
2 boson at the LHC already strongly constrain the invisible decay channel, which requires
3 $\lambda_{211} \ll 1$ or $m_S > m_h/2$.

4 The complementarity between a first order electroweak phase transition and precision
5 Higgs observables is shown in Figure 2.14 for the singlet extension of the Standard Model.
6 Orange points correspond to models with a first order phase transition, $v(T_{\text{pt}})/T_{\text{pt}} \neq 0$.
7 Blue points correspond to models with a strongly first order phase transition, $v(T_{\text{pt}})/T_{\text{pt}} \gtrsim$
8 1, which is a necessary requirement for electroweak baryogenesis (2.11). Red points
9 correspond to models with a very strongly first order phase transition that can potentially
10 be probed by the space-based gravitational wave interferometer telescope LISA.

11 Figure 2.14 shows that the models with a first order phase transition (all colored points)
12 also generally predict large deviations in the hZZ coupling. For the models with a strongly
13 first order phase transition (blue and red points) the effect on g_{hZZ} is large enough to
14 be tested by CEPC. Additionally, most of the parameter points also predict a large en-
15 hancement to the Higgs trilinear self-coupling that can be probed by a future 100 TeV
16 hadron collider experiment, like the proposed SppC. The funnel region of orange points
17 at $\lambda_3/\lambda_{3,SM} \approx 1$ corresponds to a “blind spot” where the Higgs-singlet mixing vanishes.
18 Thus, apart from the blind spot, *the reach of CEPC is sufficient to probe a first order*
19 *electroweak phase transition across the entire parameter space.*

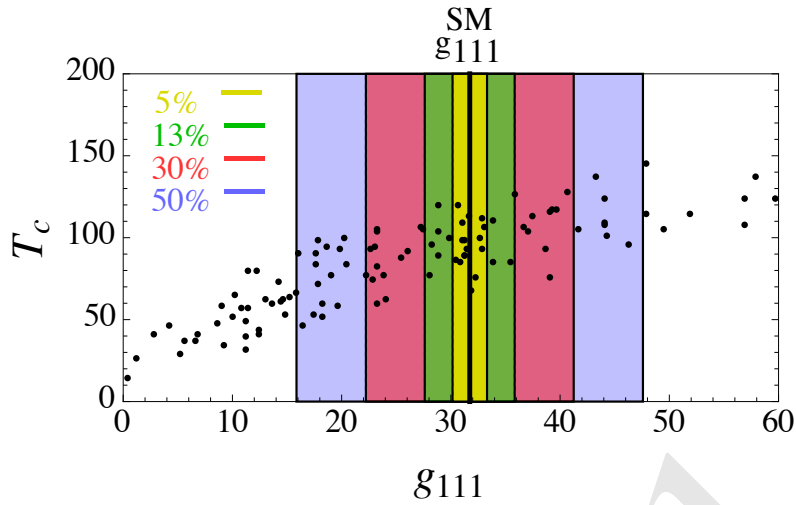

Figure 2.15: A correlation between the cubic self-coupling of the SM-like scalar boson and the critical temperature of the first order electroweak phase transition. To connect with the notation in the text, $g_{111} \rightarrow \lambda_3/(6 \text{ GeV})$ and $T_c \rightarrow T_{\text{pt}}/\text{GeV}$. The figure is reproduced from Ref. [60].

The blind spot mentioned above corresponds to two scenarios. The Higgs-singlet mixing could vanish, because of an accidental cancellation between a_{HS} and $\lambda_{HS'VS}$. This corresponds to an artificially fine-tuned parameter space, that is not theoretically appealing. Alternatively, the mixing vanishes identically in the \mathbb{Z}_2 symmetric limit of the singlet extension. In this case, the relevant parameter space is shown in Figure 2.13. The right panel shows the predicted deviation in the hZZ coupling away from the Standard Model expectation, which is comfortably within reach of CEPC's projected sensitivity.

Another representation of the parameter space appears in Figure 2.15, which shows a correlation between the phase transition temperature and the Higgs cubic self-coupling. For a similar analysis see also Ref. [61], but note that this article was published before the Higgs mass was determined.

Among all possible new physics that renders the electroweak phase transition to be first order, we focus on the singlet extension here, because it is the most challenging to test with collider experiments. To illustrate this point, one can allow the new scalar particles to carry an electric charge (similar to a two-Higgs doublet model). An analysis of this model has been performed in Ref. [59], and the results are shown in Figure 2.16. The CEPC has enough sensitivity to test the entire interesting parameter space, and much of the space will also be tested by measurements at the LHC.

What will we learn from CEPC?

The CEPC will probe the Higgs boson with unprecedented precision. While the LHC has taught us that the Higgs is responsible for electroweak symmetry breaking, measurements at CEPC provide a unique opportunity to learn *how* electroweak symmetry breaking occurs. The nature of the electroweak phase transition is a question that we cannot settle using only measurements at the LHC and its upgrades. Simple and compelling extensions of the Standard Model can have a dramatic effect on the nature of the electroweak phase transition, while remaining completely inaccessible to the LHC. However, the presence of new particles coupled to the Higgs boson must affect the way that the Higgs boson

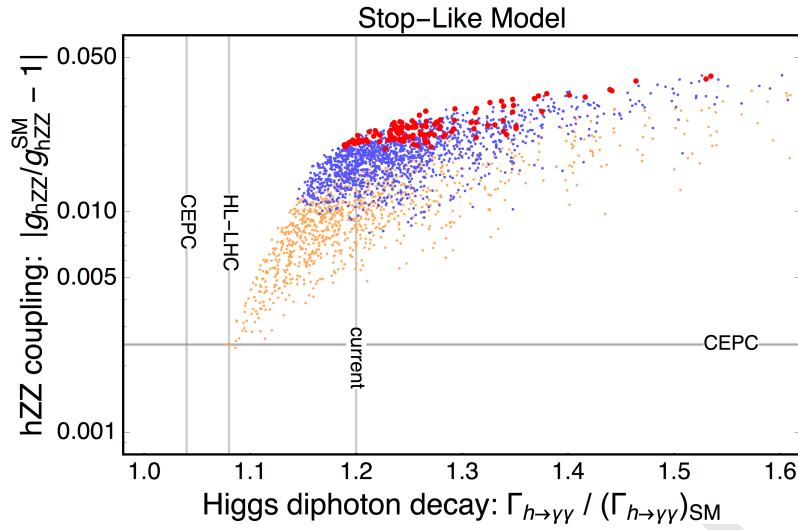

Figure 2.16: A model in which the new scalar particles are charged and uncolored. Such a model can be tested by CEPC, but it is already strongly constrained by the LHC’s measurement of the Higgs diphoton decay width. The figure is reproduced from Ref. [59].

1 couples to itself and to other Standard Model particles, such as the Z-boson. Therefore
 2 precision measurements of the Higgs couplings are precisely what’s required to expose
 3 the new physics. In particular, the strength of the hZZ coupling, which will be measured
 4 at the 0.1% level by CEPC, is an excellent litmus test for a first order electroweak phase
 5 transition.

6 2.3 Exploring new physics

7 Exotic new physics could interact with the Standard Model in multiple ways that could be
 8 tested at CEPC. Here we summarize and classify different possible scenarios, which are
 9 discussed in more detail in the following sections:

- 10 1. Exotic particles carry Standard Model charges. The classic example in the dark matter
 11 context is dark matter in electroweak multiplets: although dark matter must be neutral,
 12 it could be part of an $SU(2)$ multiplet that also contains charged particles. Because
 13 CEPC is primarily a machine for Higgs and electroweak physics, this is a natural case
 14 to consider.
- 15 2. Renormalizable Standard Model portals: if there are no new particles with Standard
 16 Model gauge interactions and no new gauge groups that the Standard Model parti-
 17 cles are charged under, exotic particles in the hidden (dark) sectors can still interact
 18 with the Standard Model via the gauge-singlet operators $H^\dagger H$ (“Higgs portal”) [62–
 19 69], $B_{\mu\nu}$ (“hypercharge portal” or kinetic mixing) [70–76], and HL (“neutrino por-
 20 tal”) [77–83].
- 21 3. Portals with additional Standard Model sector physics or new gauge groups that the
 22 Standard Model is charged under: if some exotic particle itself carries no Standard
 23 Model gauge charges, it may nonetheless interact with the Standard Model via un-
 24 known new particles with Standard Model charges. For instance, the existence of a

second Higgs doublet that couples dominantly to leptons can make models of “leptophilic” dark matter possible. The second possibility is that there exists some new gauge group, e.g. $U(1)'$, that (some) Standard Model particles are charged under. Then there is a renormalizable coupling between the new gauge boson and the current made of the Standard Model particles. If the new gauge group is anomalous with the Standard Model particle content, there could also be a Wess-Zumino type interaction between the Z and the new gauge boson [84–93].

4. Effective theory and high dimensional operators: this approach is agnostic to which of the above three scenarios we consider. The theory only contains certain light exotic particles and the Standard Model. The other new physics that generates the coupling between them is not identified and is only encoded in Wilson coefficients. Examples include an axion-like particle (ALP) interacting with the Z boson or photon through dimension-five operators [94–106] and magnetic inelastic dark matter and Rayleigh dark matter models [107–111], in which the dark sector interacts with Z via even higher dimensional operators.

These different scenarios may result in modifications to precision Higgs and Z observables or to exotic Higgs and Z decays. The first type of signal has been discussed in Chapter 2. In Sections 2.3.1 and 2.3.2, we will discuss the potential of CEPC for measuring exotic Higgs and Z decays. Then in Section 2.3.3, we will focus on the implications for dark matter and dark sectors. In Sections 2.3.4 and 2.3.5, we will discuss the potential of measuring exotic physics connected to neutrino and flavor physics.

2.3.1 Exotic Higgs boson decays

Higgs boson can be an important portal to new physics beyond the Standard Model. Such new physics could manifest itself through Higgs exotic decays if some of the degrees of freedom are light. The Higgs boson BSM decays have a rich variety of possibilities. Two-body Higgs decays into BSM particles $H \rightarrow X_1 X_2$, where the BSM particles X_i are allowed to subsequently decay further, are considered here. These decay modes are classified into four cases, schematically shown in Figure 2.17. These processes are well-motivated by BSM models such as singlet extensions of the SM, two-Higgs-doublet-models, SUSY models, Higgs portals, gauge extensions of the SM, and so on [112–114].

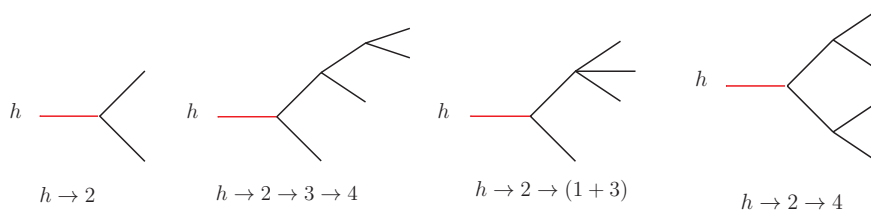

Figure 2.17: The topologies of the SM-like Higgs exotic decays.

For CEPC running at the center of mass energy 240 GeV, the most important Higgs production mechanism is Z -Higgs associated production $e^+e^- \rightarrow Z^* \rightarrow ZH$. The Z boson with visible decays enables Higgs tagging using the “recoil mass” technique. A cut around the peak of the recoil mass spectrum would remove the majority of the SM background. Further selection and tagging on the Higgs decay product can hence achieve

Decay Mode	95% C.L. limit on Br		
	LHC	HL-LHC	CEPC
E_T^{miss}	0.23	0.056	0.030
$(b\bar{b}) + E_T^{\text{miss}}$	–	[0.2]	1×10^{-4}
$(jj) + E_T^{\text{miss}}$	–	–	4×10^{-4}
$(\tau^+\tau^-) + E_T^{\text{miss}}$	–	[1]	8×10^{-5}
$b\bar{b} + E_T^{\text{miss}}$	–	[0.2]	2×10^{-4}
$jj + E_T^{\text{miss}}$	–	–	5×10^{-4}
$\tau^+\tau^- + E_T^{\text{miss}}$	–	–	8×10^{-5}
$(b\bar{b})(b\bar{b})$	1.7	(0.2)	6×10^{-4}
$(c\bar{c})(c\bar{c})$	–	(0.2)	8×10^{-4}
$(jj)(jj)$	–	[0.1]	2×10^{-3}
$(b\bar{b})(\tau^+\tau^-)$	[0.1]	[0.15]	4×10^{-4}
$(\tau^+\tau^-)(\tau^+\tau^-)$	[1.2]	[0.2 ~ 0.4]	2×10^{-4}
$(jj)(\gamma\gamma)$	–	[0.01]	1×10^{-4}
$(\gamma\gamma)(\gamma\gamma)$	$[7 \times 10^{-3}]$	4×10^{-4}	8×10^{-5}

Table 2.1: The current and projected limits on Higgs exotic decay modes for the (HL-)LHC and CEPC with 5 ab^{-1} integrated luminosity, based upon results from Ref. [114]. The projections for the HL-LHC are collected in the third column, where the limits for 100 fb^{-1} and 300 fb^{-1} alone are shown in parentheses and square brackets, respectively.

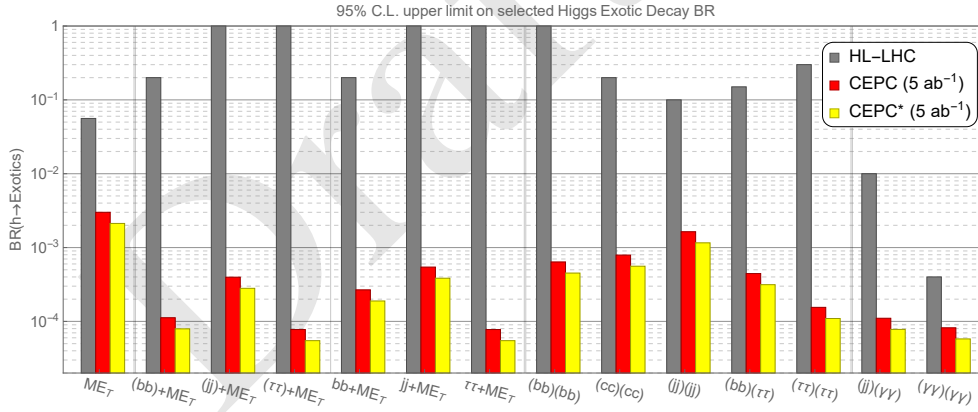

Figure 2.18: The 95% C.L. upper limit on selected Higgs exotic decay branching fractions at HL-LHC and CEPC, based on Ref. [114]. The benchmark parameter choices are the same as in Table 2.1. The red bars correspond to the results using only leptonic decays of the spectator Z -boson. The yellow bars further include extrapolation with the inclusion of the hadronic decays of the spectator Z -boson. Several vertical lines are drawn in this figure to divide different types of Higgs exotic decays.

- 1 high signal efficiency, and the major background would be from the Higgs SM decays.
- 2 The details of these analysis can be found in Ref. [114].
- 3 The set of Higgs exotic decays with their projected LHC constraints and limits from the
- 4 CEPC with 5 ab^{-1} integrated luminosity are summarized in Table 2.1. For the LHC con-
- 5 straints, both the current limits and projected limits on these exotic decay channels from
- 6 various references are tabulated. The comparison are performed for particular benchmark
- 7 points to demonstrate the qualitative difference between the (HL-)LHC and CEPC.

1 The exotic Higgs decay channels summarized in Table 2.1 and the corresponding Fig-
 2 ure 2.19 are among the most difficult modes to constrain at the LHC and exemplify the
 3 considerable sensitivity of the CEPC. The red bars in Figure 2.19 correspond to a recoil
 4 mass analysis that only uses leptonic decays of the Z -boson that is produced in association
 5 with the Higgs boson. The inclusion of hadronic decays of the Z -boson provides around
 6 ten times more statistics and would lead to substantially improved reach. Based upon the
 7 study of Higgs decays $H \rightarrow WW^*$, ZZ^* and invisibles, hadronically decaying Z -bosons
 8 are conservatively assumed to provide a limit comparable to the limit from leptonic Z -
 9 bosons, and hence improve the limits by around 40% when combined. These extrapolated
 10 results are shown in yellow bars in Figure 2.18.

11 In comparison with the HL-LHC, the improved coverage of Higgs exotic branching
 12 fractions is significant, varying from one to four orders of magnitude for the channels un-
 13 der consideration. For the Higgs exotic decays into hadronic final states plus missing en-
 14 ergy, $b\bar{b} + E_T^{\text{miss}}$, $jj + E_T^{\text{miss}}$ and $\tau^+\tau^- + E_T^{\text{miss}}$, CEPC improves on the HL-LHC sensitivity
 15 for these channels by three to four orders of magnitude. These significant improvements
 16 benefit from low QCD backgrounds and the Higgs tagging from recoil mass reconstruc-
 17 tion at CEPC. As for the Higgs exotic decays without missing energy, the comparative
 18 improvements vary between two to three orders of magnitude, as LHC performance in
 19 these channels is improved by reconstruction of the Higgs mass from visible final state
 20 particles and reduced QCD backgrounds in events with leptons and photons.

21 2.3.2 Exotic Z boson decays

22 The CEPC's Z -pole run will offer unique possibilities to test new physics that allows the
 23 Z boson to decay through new, exotic channels. Figure 2.19 summarizes the sensitivity
 24 of CEPC to exotic Z decays, and it compares CEPC's sensitivity to that of the high-
 25 luminosity LHC (HL-LHC) and a proposed Tera Z upgrade. Exotic Z decay channels are
 26 classified by final states, the number of intermediate resonances, and different topologies.
 27 The final states considered here include $Z \rightarrow \cancel{E} + \gamma$, $\cancel{E} + \gamma\gamma$, $\cancel{E} + \ell^+\ell^-$, $\cancel{E} + JJ$,
 28 $(JJ)(JJ)$ and $\gamma\gamma\gamma$. Each pair of photons, charged leptons, or jets can form a resonance,
 29 denoted with $(\)$. All six categories of final states are represented in Figure 2.19; several
 30 representative decay topologies are chosen for each category and correspondingly labeled
 31 on the bar-chart. For CEPC and Tera Z , the sensitivity reach for exotic Z decay branching
 32 ratios (BR) are plotted as blue and red bars. These projections include kinematic cuts,
 33 namely general p_T and angular cuts on reconstructed objects, as well as an appropriate
 34 invariant mass cut if there is a resonance in the pair of particles (including dark matter
 35 particles). The cuts are optimized for each topology by checking the kinematic variable
 36 distributions. The sensitivity reach for the HL-LHC at 13 TeV with $\mathcal{L} = 3 \text{ ab}^{-1}$ has been
 37 computed in a similar way. Details of the simulation can be found in Ref. [115].

38 The sensitivity to final states with missing energy reaches branching ratios of 10^{-6} to
 39 $10^{-9.5}$ for CEPC and 10^{-7} to $10^{-11.5}$ for Tera Z . For each topology, the light blue and
 40 red shaded regions indicate the range from varying the model parameters, like mediator
 41 or dark matter mass. The light color regions with dashed boundary show the optimal sen-
 42 sitivity, while the dark color regions with solid boundary show the pessimistic benchmark
 43 of the model. In all the channels, future Z factories improve the sensitivity by several
 44 orders of magnitude above those of the HL-LHC.

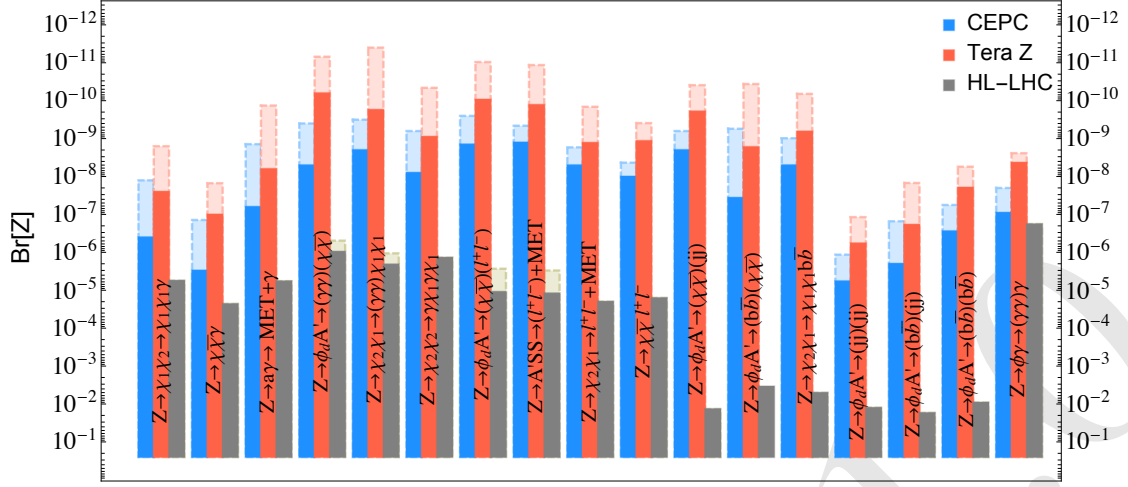

Figure 2.19: The sensitivity reach in the Z branching ratio for various exotic Z decay topologies at CEPC (10^{10} Z), a possible extension to Tera Z (10^{12} Z), and the high luminosity LHC at 13 TeV with $\mathcal{L} = 3 \text{ ab}^{-1}$. Adapted from Ref. [115].

1 In general, CEPC has several advantages compared to a hadron collider like the HL-
 2 LHC. First, an e^+e^- collider has a much cleaner environment compared to a hadron col-
 3 lider with a huge QCD background. Second, in the Drell-Yan production of a Z boson at
 4 a hadron collider, the decay products tends to be soft because the Z boson mass is small
 5 compared to the beam energy, which makes them hard to detect at the HL-LHC. There-
 6 fore, it is natural that CEPC has better sensitivity compared to the HL-LHC and provides
 7 a better opportunity to investigate dark sector physics through exotic Z decays.

8 Two specific benchmark scenarios demonstrate the significant power of exotic Z decays
 9 to probe different dark (hidden) sectors [115]. (Further discussion of a variety of exotic Z
 10 decays appears in [116].) The first model contains fermionic dark matter interacting with
 11 a singlet real scalar S , which mixes with the Standard Model Higgs. The possible exotic
 12 Z decay channel in this case is $Z \rightarrow \tilde{s} Z^* \rightarrow (\bar{\chi}\chi) + \ell^+\ell^-$, where \tilde{s} is the light scalar
 13 mass eigenstate (mostly the dark Higgs S) and χ is the fermionic dark matter. The second
 14 model is an axion-like particle a coupling to the Standard Model $U(1)_Y$ gauge field B_μ .
 15 Then the exotic Z decay is $Z \rightarrow a\gamma \rightarrow (\gamma\gamma)\gamma$. The final state is 3γ and in the case
 16 that m_a is too small to separate the two photons, the final state is 2γ . The sensitivity of
 17 exotic Z decays (as well as other possible probes) to key parameters in these two models
 18 is summarized in Figure 2.20.

19 Projections for CEPC and Tera Z reach in the first model are shown in the left panel
 20 of Figure 2.20. There are two free parameters, namely the Higgs mixing angle $\sin\alpha$ and
 21 dark Higgs mass $m_{\tilde{s}}$. The other two parameters related to dark matter are fixed. One is
 22 the dark matter mass, fixed close to half of $m_{\tilde{s}}$, which only affects the dark matter relic
 23 abundance but not other limits. The other one is the Yukawa coupling between dark matter
 24 χ and the dark Higgs \tilde{s} , which is taken to be $y_\chi = 0.1$ for illustrative purposes. Limits
 25 are projected for the exotic Z decay process $Z \rightarrow \ell^+\ell^-\tilde{s} \rightarrow \ell^+\ell^-(\bar{\chi}\chi)$, which has been
 26 labeled as an orange solid line for CEPC (10^{10} Z) option and a red dot-dashed line for the

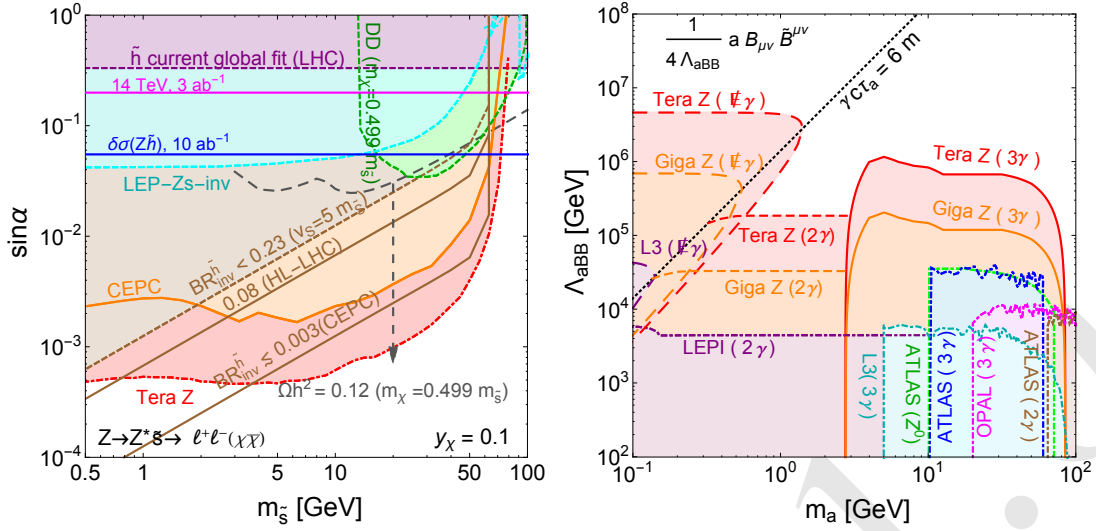

Figure 2.20: The reach for rare Z decays at CEPC in two benchmark scenarios, adapted from Ref. [115]. **Left:** the sensitivity to the dark Higgs mixing angle $\sin \alpha$ at CEPC ($10^{10} Z$) and at a Tera Z option ($10^{12} Z$) in a Higgs portal dark matter model, using the process $Z \rightarrow \ell^+ \ell^- \tilde{s} \rightarrow \ell^+ \ell^- (\tilde{\chi}\chi)$. **Right:** the sensitivity to the coupling Λ_{aBB} for an axion-like particle (ALP) model as a function of the ALP mass m_a , where B is the hypercharge gauge field. The signal process is $Z \rightarrow \gamma a$, where a can decay to a pair of photons (3γ), be detected as one photon due to high boost (2γ), or be detected as missing energy due to its long lifetime ($\cancel{\gamma}$).

1 Tera Z ($10^{12} Z$) option, and compared with the LEP result with an integrated luminosity
 2 114 pb^{-1} [117] labeled as “LEP-Zs-inv”.

3 The dark Higgs in this benchmark scenario can also be constrained by the modification
 4 of SM Higgs couplings proportional to the mixing angle $\sin \alpha$, independent of the scalar
 5 mass \tilde{s} . The global fit to Higgs data at the LHC 7 TeV and 8 TeV runs can constrain the
 6 single scaling factor to Higgs interactions, giving $\sin \alpha < 0.33$ [118]; this is labeled as
 7 “ \tilde{h} current global fit (LHC)”. The HL-LHC can extend this reach to $\sin \alpha < 0.28$ (0.20)
 8 using 300 fb^{-1} (3 ab^{-1}) luminosity [119]. At CEPC, the precision measurement of the
 9 Higgs bremsstrahlung cross-section $\sigma(Zh)$ can reach the accuracy of $O(0.3\% - 0.7\%)$
 10 expected from $5 - 10 \text{ ab}^{-1}$ [120–122], which can probe the scalar mixing down to $0.055 -$
 11 0.084 [123]; this is labeled as “ $\delta\sigma(Zh)$ ”. In addition, there are constraints coming from
 12 the invisible decay of the SM Higgs. The current LHC limits from the Run I combination
 13 of ATLAS and CMS data constrains $\text{BR}(h \rightarrow \text{inv}) \leq 0.23$ at 95% C.L. [124, 125].
 14 Following the \tilde{h} invisible decay branching ratio in the Higgs portal dark matter model, the
 15 limit on the mixing angle $\sin \alpha$ is labeled as “ $\text{BR}_{\text{inv}}^{\tilde{h}} < 0.23$ ”. We also add the HL-LHC
 16 (3 ab^{-1}) and future e^+e^- collider projections on invisible Higgs search, which lead to
 17 95% C.L. limits $\text{BR}_{\text{inv}}^{\tilde{h}} \lesssim 0.08 \sim 0.16$ [126, 127] and $\text{BR}_{\text{inv}}^{\tilde{h}} \lesssim 0.003$ [121, 128] at ILC
 18 and CEPC. There are also constraints based on dark matter assumptions. The dark matter
 19 relic abundance [129] is satisfied on the dashed gray line, while the direct detection limits
 20 on spin-independent cross-sections (XENON1T [130], LUX [131], PANDAX-II [132],
 21 and CRESST-II [133]) exclude the region within the dashed green line.

22 Projections for CEPC and Tera Z reach in the second model are illustrated in the right
 23 panel of Figure 2.20, focusing on the exotic Z decay $Z \rightarrow \gamma a$ followed by $a \rightarrow \gamma\gamma$. In
 24 the 3γ signal, the ALP mass is heavy enough that the two photons are well separated and

1 detectable. When the mass of the ALP is below $O(1)$ GeV, the boost of the axion makes
 2 the two photons from the axion decay close enough together that they cannot be resolved,
 3 leading to signals in the 2γ search channel. The current constraints on the two cases are
 4 given by LEP and LHC photon searches. In Figure 2.20, the LEP I [134] constraint uses an
 5 inclusive diphoton search $e^+e^- \rightarrow 2\gamma + X$ covering the small mass region. In the higher
 6 mass region, the boost of the axion decreases and the 3γ channel is considered. The LEP
 7 II (OPAL) constraints have 2γ and 3γ data [135], which are employed to put bounds on
 8 the process $e^+e^- \rightarrow \gamma/Z^* \rightarrow a\gamma \rightarrow 2\gamma + \gamma$. ATLAS 3γ and $Z \rightarrow 3\gamma$ [136, 137] searches
 9 can be translated to an ALP bound, as derived in [138]. There is also the possibility
 10 that the ALP decays outside of the detector, which is relevant for a $\cancel{E} + \gamma$ search. In
 11 this case the strongest bound comes from the LEP L3 collaboration with 137 pb^{-1} data
 12 at the Z pole [139], which constrains the branching ratio of the exotic decay $Z \rightarrow \gamma\cancel{E}$
 13 down to 1.1×10^{-6} if the photon energy is greater than ~ 30 GeV. It directly excludes
 14 $\Lambda_{\text{aBB}} < 4.3 \times 10^4$ GeV for $Z \rightarrow \cancel{E} + \gamma$ decay, and is labeled as “L3 ($\cancel{E}\gamma$)” in the right panel
 15 of Figure 2.20. The sensitivity curves are plotted as an orange solid line for CEPC (10^{10}
 16 Z) and a red dot-dashed line for a Tera Z (10^{12} Z) option, demonstrating the significant
 17 reach of CEPC and Tera Z in this scenario.

18 These comparisons show that searches for exotic Z decays at CEPC (and a possible
 19 Tera Z extension) can provide the leading sensitivity to a range of motivated extensions
 20 of the Standard Model, substantially exceeding the reach of dark matter direct detection
 21 experiments, current limits from collider searches, and estimated sensitivities of the high
 22 luminosity run of the LHC (HL-LHC).

23 2.3.3 Dark matter and hidden sectors

24 Observations tell us that the majority of matter in the universe is dark matter (DM). Be-
 25 cause the abundance of dark matter in the universe is within an order of magnitude of the
 26 abundance of ordinary matter, it is natural to suspect that dark matter and ordinary matter
 27 should be related in some way. A variety of models, including the classic thermal relic
 28 weakly interacting massive particle (WIMP), attempt to explain the abundance of dark
 29 matter in terms of its interactions with ordinary matter. In some models, there is a richer
 30 “dark sector” consisting not only of dark matter itself but of new force-carrying particles
 31 that can mediate self-interactions between dark matter particles or interactions of dark
 32 matter with ordinary matter.

33 Different classes of possibilities for how dark matter interacts with the Standard Model
 34 have been summarized in Section 2.3. Below we discuss each of these possibilities in turn.
 35 This categorization of studies may be useful in the future for identifying DM scenarios at
 36 CEPC that have not yet been fully studied.

37 There are major efforts underway to search for dark matter via direct detection, indirect
 38 detection, and searches at the LHC and lower-energy-but-high-luminosity collider and
 39 fixed-target experiments. It is possible that one of these experiments will discover a dark
 40 matter signal before CEPC operates. Even in that case, CEPC can play a crucial role in
 41 discovering the *nature* of the dark matter particle. Direct detection, for example, may
 42 tell us a spin-independent scattering rate, but without knowledge of the local dark matter
 43 density or whether the particle we are seeing constitutes all of the dark matter or is just a
 44 component, limited knowledge of particle physics would be gleaned from the discovery.
 45 The role of CEPC in such a case could be to tell us that dark matter interacts directly with

1 the Higgs boson or weak gauge bosons, for instance. Below we will emphasize both cases
 2 in which CEPC can *measure* dark matter properties and supplement other experiments
 3 and cases in which CEPC could play the crucial role in *discovering* a DM signal for the
 4 first time.

5 **Dark matter in electroweak multiplets**

6 The CEPC's strength is electroweak physics, both through precision measurements of
 7 properties of the W and Z bosons and through its primary role as a Higgs factory. Studies
 8 of CEPC's capabilities for detecting new electroweak physics include Refs. [20, 23, 40,
 9 140–146]. Hence, the most natural place to begin is with CEPC searches for dark matter
 10 particles that are in electroweak multiplets (e.g. doublets or triplets of $SU(2)_L$) or mixtures
 11 of electroweak multiplets (including admixtures of a singlet). Studies on this topic include
 12 Refs. [147–152].

13 One question is whether other, dedicated dark matter experiments will cover the full
 14 parameter space of dark matter in electroweak multiplets. Dark matter direct detection
 15 experiments, like the currently-operating Xenon1T [130] and PandaX [153], are currently
 16 probing much of the parameter space for spin-independent dark matter scattering on nu-
 17 cleons mediated by Higgs exchange. The current bound on the DM-nucleon cross section
 18 of a few times 10^{-46} cm² corresponds to an $h\chi\chi$ coupling in the Lagrangian with coef-
 19 ficient of order 10^{-2} . Future experiments like DARWIN [154] will potentially push the
 20 search down to the neutrino floor, corresponding to $h\chi\chi$ couplings of order 10^{-3} . This
 21 will probe a large swath of the parameter space for electroweak dark matter.

22 As noted above, CEPC could help to measure DM properties even if a direct detection
 23 experiment makes the discovery first. Still more interesting are possibilities in which
 24 electroweak DM could be *missed* by direct detection experiments but seen by CEPC.
 25 There are two main scenarios to consider where this could happen. The first is if DM is a
 26 nearly pure electroweak multiplet, such as a pseudo-Dirac higgsino. Such particles have
 27 very small interactions with the Higgs, so their direct detection rate is loop-suppressed and
 28 at about the level of the neutrino floor [155]. These particles would also be very difficult
 29 to detect at the LHC [156]. Indirect detection may constrain them, but at low mass their
 30 thermal abundance is low, and even a significant non-thermal abundance may fall below
 31 current constraints [157, 158]. A second possibility is that DM lies in a mixed electroweak
 32 multiplet with couplings to the Higgs, but the coupling of the lightest mass eigenstate has
 33 a small coupling to the Higgs, either accidentally or due to an approximate symmetry.
 34 This is referred to as a *blind spot* for direct detection [159, 160]. For instance, a mostly-
 35 wino dark matter particle in a supersymmetric theory has vanishing tree-level coupling to
 36 the Higgs boson if $M_2 = -\mu \sin(2\beta)$. In some cases, a spin-independent blind spot may
 37 be covered by spin-dependent scattering. Blind spots might also be uncovered by collider
 38 searches [161].

39 Robust blind spots for both spin-dependent and spin-independent scattering arise in
 40 some theories due to approximate *parity* or *custodial* symmetries. In the MSSM, this
 41 occurs for higgsino dark matter at $\tan\beta = 1$ and $\text{sign}(\mu M_{1,2}) < 0$. In closely related
 42 theories, these blind spots have been understood to result from custodial symmetries [148].
 43 These robust direct detection blind spots are excellent opportunities for CEPC to play a
 44 role in dark matter physics, so let us explain the physics in somewhat more detail. They
 45 arise for pseudo-Dirac DM, i.e. theories with a Dirac mass term of the form $\mu\chi_1\chi_2$ which
 46 can be written as a sum of two Majorana mass terms, $\mu(\chi_+\chi_+ - \chi_-\chi_-)$ where $\chi_{\pm} =$

1 $(\chi_1 \pm \chi_2)/\sqrt{2}$. In such a theory the Z boson couples off-diagonally, $Z_\mu(\chi_+^\dagger \bar{\sigma}^\mu \chi_- + \text{h.c.})$.
 2 Mixing or higher-dimension operators can split the mass eigenstates, but in the custodially
 3 symmetric limit, the eigenstates remain χ_+ and χ_- rather than mixtures thereof. There is
 4 a parity symmetry under which χ_+ and the Z are odd but χ_- and h are even, which forbids
 5 an $h\chi_+\chi_+$ coupling. Hence when χ_+ is the lighter mass eigenstate, both spin-dependent
 6 and spin-independent scattering are turned off.

7 A number of studies have been carried out on two particular models of electroweak dark
 8 matter, the doublet–singlet and doublet–triplet models (e.g. [162–164]). The doublet–
 9 singlet model introduces a singlet fermion S (with zero hypercharge) with Majorana
 10 mass $-(m_S/2)SS$ and two electroweak doublet Weyl fermions $D_{1,2}$ with opposite hy-
 11 percharges $\mp 1/2$ and Dirac mass $-m_D \epsilon_{ij} D_1^i D_2^j$, together with mixing through the SM
 12 Higgs:

$$y_1 H S D_1 - y_2 H^\dagger S D_2 + \text{h.c.} . \quad (2.19)$$

13 The doublet–triplet model introduces the same doublet fields as well as an $SU(2)$ triplet
 14 with zero hypercharge, T , with a Majorana mass $-(m_T/2)T^i T^i$ and mixing with the
 15 doublet through the Higgs:

$$y_1 (H \sigma^i D_1) T^i - y_2 (H^\dagger \sigma^i D_2) T^i + \text{h.c.} . \quad (2.20)$$

16 Both of these models have blind spots for both spin-independent *and* spin-dependent di-
 17 rect detection in the pseudo-Dirac case when $m_D < m_{S,T}$ (all mass parameters taken to
 18 be positive) and $y_1 = y_2$. An explicit rewriting of the Lagrangian that makes a custodial
 19 symmetry manifest in this limit has been given in [148]. This blind spot can also be un-
 20 derstood in terms of a parity symmetry at the point $y_1 = y_2$ along the lines explained in
 21 the previous paragraph.

22 In the SUSY context we can identify the fields S , D , and T with the bino, higgsino,
 23 and wino. In this case the couplings y_1 and y_2 are equivalent to $g^{(\prime)} \cos \beta$ and $g^{(\prime)} \sin \beta$
 24 in the doublet–triplet (doublet–singlet) case. These relatively small couplings tend to lead to
 25 small signals at CEPC. However, it is also interesting to consider extensions of the MSSM
 26 with an *additional* doublet and singlet that mix to serve as dark matter. Such theories can
 27 help to explain why the observed Higgs mass is heavier than expected in the simplest
 28 SUSY theories [165], which offers a motivation for considering the larger values of $y_{1,2}$
 29 that could be probed at CEPC.

30 Precision electroweak physics at the Z pole is most sensitive to the S and T parameters.
 31 Although these operators appear in studying the propagators of gauge fields, they originate
 32 from new physics that couples to the Higgs. For instance, in the basis of Ref. [166],
 33 the S parameter is related to the operators $H^\dagger \sigma^i H W_{\mu\nu}^i B^{\mu\nu}$, $(H^\dagger \sigma^i \overleftrightarrow{D}_\mu H) D^\nu W_{\mu\nu}^i$, and
 34 $(H^\dagger \overleftrightarrow{D}_\mu H) \partial^\nu B_{\mu\nu}$; the T parameter, to $(H^\dagger \overleftrightarrow{D}_\mu H)^2$. These operators are generated in
 35 the doublet–singlet or doublet–triplet model because the fermions mix by coupling to
 36 the Higgs boson. On the other hand, for a pure electroweak multiplet like the pseudo-
 37 Dirac higgsino, Higgs couplings are very small and S and T are suppressed. The T
 38 parameter is also suppressed in models with a good approximate custodial symmetry.
 39 In such theories, other electroweak precision observables like the W and Y operators
 40 $(D^\mu W_{\mu\nu}^i)^2$ or $(\partial^\mu B_{\mu\nu})^2$ may be relatively important, though they are generated with small
 41 coefficients and are harder to probe. In this case, observables at 240 GeV from processes
 42 like $e^+e^- \rightarrow \mu^+\mu^-$ [167] or $e^+e^- \rightarrow W^+W^-$ [149, 168] may be more effective probes
 43 of electroweak dark matter than Z -pole observables.

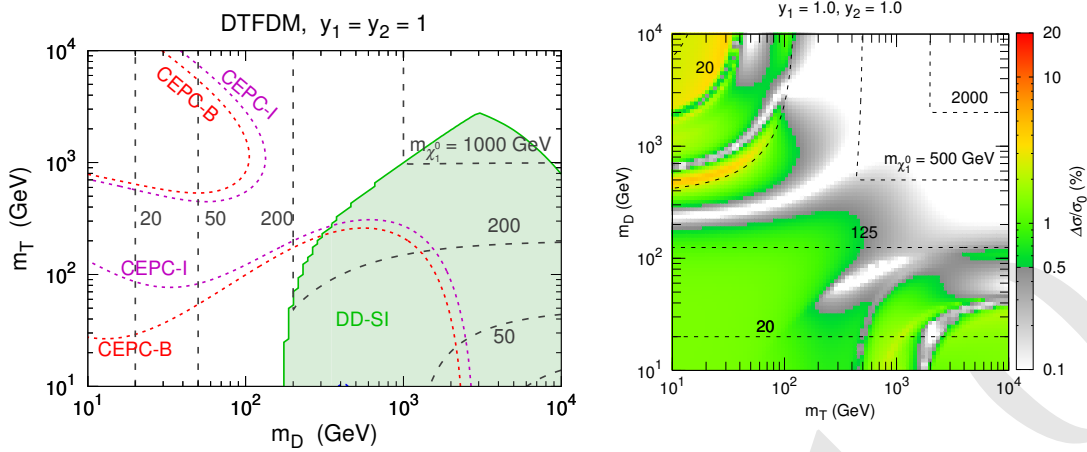

Figure 2.21: **Left:** The CEPC electroweak precision (S, T) fit probe of the doublet–triplet model at the custodially symmetric point $y_1 = y_2 = 1$, taken directly from Figure 5a of Ref. [148]. When the dark matter particle is mostly triplet ($m_D \gg m_T$), spin-independent direct detection is a powerful probe (shaded green region). When the dark matter particle is mostly doublet, the tree-level direct detection rate vanishes but CEPC’s measurement of the S parameter becomes a powerful probe (dashed contours). **Right:** CEPC’s sensitivity to the same model via the Higgsstrahlung cross section $\sigma(Zh)$, taken directly from Figure 11b of Ref. [151]. We see that in a large part of parameter space with $m_T \gg m_D$, where the direct detection rate is low due to custodial symmetry, there are observable (percent-level or higher) deviations in the Zh cross section.

1 The doublet–singlet and doublet–triplet models at CEPC have been discussed in Ref. [148],
 2 which focuses on the S and T parameters (and also discusses a quadruplet–triplet model
 3 with similar properties).¹ They have shown that CEPC can probe a large region of param-
 4 eter space where the dark matter mass is below 200 GeV, and certain regions of parameter
 5 space with even larger masses. In particular, the S parameter allows a probe of the custo-
 6 dially symmetric region that is hidden from direct detection. We show some results from
 7 this paper in the left-hand panel of Figure 2.21. A related study in Ref. [151] considers
 8 effects of doublet–singlet and doublet–triplet dark matter on Higgs observables, includ-
 9 ing the Zh cross section, the $h \rightarrow \gamma\gamma$ decay rate, and the Higgs invisible width. Away
 10 from the custodially symmetric point in the doublet–singlet model, when $y_1 = 0.5$ and
 11 $y_2 = 1.5$, CEPC’s measurement of the total Zh cross section probes the lightest neutralino
 12 mass up to 200 GeV. For $y_1 = y_2 = 1$, with custodial symmetry, deviations are smaller
 13 and m_D is probed only up to about 125 GeV. In the doublet–triplet case, the region of
 14 parameter space bounded by the Zh measurement is illustrated in the right-hand panel of
 15 Figure 2.21. Aspects of a slightly different doublet–singlet model, with the singlet taken
 16 to be a Dirac fermion, have also been discussed in Ref. [147]. They focus on the region
 17 with mostly singlet DM, in which case the doublet may be thought of as allowing a com-
 18 pletion of a “Higgs portal” model. In this case, the most important constraints come from
 19 the T parameter. They also present results for a wider range of doublet and singlet masses
 20 including cases where dark matter is mostly doublet.

¹Earlier papers discussing electroweak and Higgs constraints on similar models include [169–173].

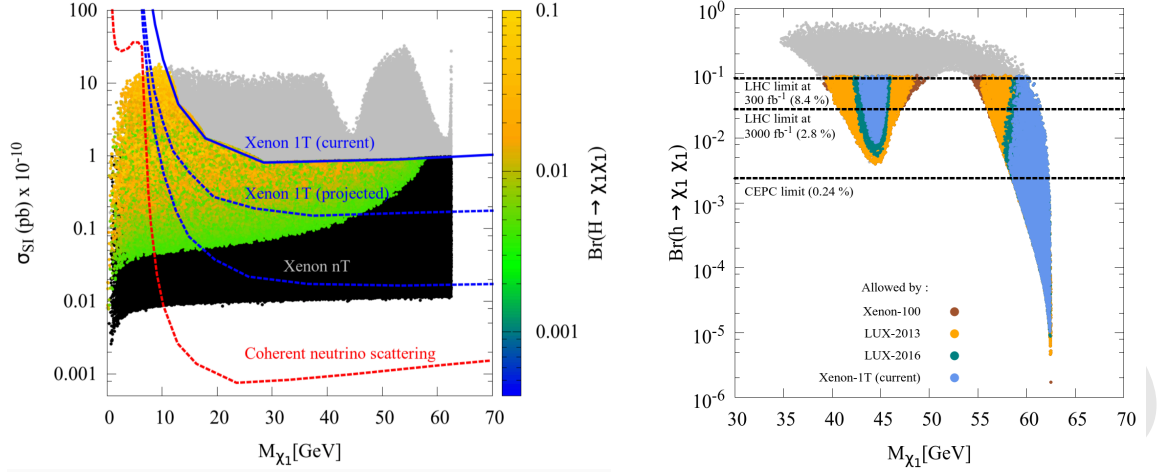

Figure 2.22: These figures, which are adapted from Ref. [174], show constraints on nonthermal neutralino dark matter and invisible Higgs decays. **Left:** The spin-independent WIMP-nucleon cross-section vs $M_{\tilde{\chi}_1^0}$ for all points allowed by collider and relic density constraints. The color code characterizes the value of $\text{Br}(h \rightarrow \tilde{\chi}_1^0 \tilde{\chi}_1^0)$, while black points have $\text{Br}(h \rightarrow \tilde{\chi}_1^0 \tilde{\chi}_1^0) < 0.4\%$. The solid blue line shows the current limit from LUX-2016 [175], and the dashed blue line shows the reach for Xenon1T [176] and Xenon-nT [176]. **Right:** The Higgs to invisible branching ratio $\text{Br}(h \rightarrow \tilde{\chi}_1^0 \tilde{\chi}_1^0)$ vs. the LSP mass $M_{\tilde{\chi}_1^0}$. The grey (colored) points distinguish the points allowed before (after) the Higgs signal strength constraints. Blue, green, yellow, red points are allowed by the current limits on SI WIMP-nucleon cross-section from Xenon1T, LUX-2016, LUX-2013, and Xenon-100. From top to bottom, the black-dashed line represents the reach of the LHC with 300 fb^{-1} , the LHC with 3000 fb^{-1} , and CEPC.

1 In the case in which DM resides in a nearly pure electroweak multiplet, the S and T
2 parameters and the $h \rightarrow \gamma\gamma$ rate are no longer useful probes. For the case of nearly pure
3 higgsinos, Ref. [149] has studied the prospects of an $e^+e^- \rightarrow W^+W^-$ measurement at
4 CEPC as a constraint. This measurement is sensitive not only to corrections to the photon
5 and Z propagators but to loop corrections to the triple gauge coupling vertex. Ref. [149]
6 claims that a 0.1% precision measurement of $e^+e^- \rightarrow W^+W^-$ at CEPC could probe
7 higgsino dark matter up to about 210 GeV. However, the scatter plot in Figure 1 of that
8 reference suggests that many models with even heavier higgsinos will be accessible. A
9 more detailed future exploration of the parameter space probed by the W^+W^- measure-
10 ment would be useful. The rate of $e^+e^- \rightarrow \mu^+\mu^-$ at 240 GeV can also be a sensitive
11 probe of deviations in the propagators of photons and Z bosons; in particular, for new
12 physics contributing to the W and Y parameters but not to S and T , it may be superior
13 to electroweak precision studies on the Z pole thanks to the larger center-of-mass energy.
14 A detailed study of this probe of electroweak physics has been carried out in Ref. [167].
15 Their conclusion is that if systematic uncertainties can be controlled to achieve a 0.1%
16 precision on the rate, pseudo-Dirac higgsinos may be excluded up to a mass of about
17 200 GeV. This is encouraging, since pseudo-Dirac doublets are among the most difficult
18 electroweak particles to probe in any experiment. In particular, the LHC is not expected
19 to reach far above 200 GeV (though this will depend in part on how well systematic un-
20 certainties can be understood). The results of Ref. [167] may not apply directly to CEPC
21 due to their assumptions about beam polarization, so a further dedicated CEPC study of
22 this process is warranted.

Another interesting possibility is that of light singlet dark matter mixing with heavier electroweak-charged particles. A particular example arises for mostly-bino dark matter in the MSSM [174], $\tilde{\chi}_1^0$, which could have a non-thermal relic abundance. Because the bino is a pure singlet, it couples to the Standard Model only through small mixing parameters and is difficult to detect directly. However, in some cases it can be detected through the invisible width of the Higgs boson. The parameter space probed by dark matter direct detection and CEPC is shown in the right panel of Figure 2.22. This figure illustrates that CEPC could probe the region allowed by the current direct detection with a sensitivity to $\text{Br}(h \rightarrow \tilde{\chi}_1^0 \tilde{\chi}_1^0) \gtrsim 0.24\%$.

Standard Model portals

If the dark matter does not reside in an electroweak multiplet, it may still interact with the SM particles through gauge-invariant ‘‘portal’’ operators. The portal operators include

$$H^\dagger H, \quad B^{\mu\nu}, \quad \text{and} \quad HL, \quad (2.21)$$

where H is the SM Higgs doublet, $B^{\mu\nu}$ is the hypercharge field strength tensor, and L is a SM lepton doublet. These three portals are usually referred to as the Higgs portal, the kinetic mixing (or hypercharge) portal, and the lepton (neutrino) portal. These simple portal dark matter scenarios predict rich phenomenology and a plethora of experimental signatures. They have been established as well-defined dark matter benchmarks and experimental targets, in addition to the traditional electroweak WIMP scenario.

The many powerful direct and indirect probes available at the CEPC mean that it could play an important role in detecting and testing these SM portals to dark matter. Below we will present estimates of the CEPC potential for the Higgs and kinetic mixing portals based on the studies in the existing literature. The neutrino portal is discussed further in Section 2.3.4.

In a simple example of the Higgs portal model, the dark matter (DM) is assumed to be either a real scalar (S) or a Majorana fermion (χ), with the following interaction terms with the Higgs field [177, 178]

$$\mathcal{L} = -H^\dagger H \left(\frac{\lambda_{\text{DM}}}{4} S^2 + \bar{\chi} \frac{y_{\text{DM}} + iy_{\text{DM}}^P \gamma_5}{\sqrt{2}v} \chi \right). \quad (2.22)$$

The couplings between a single Higgs particle and the dark matter fields are thus given by

$$\mathcal{L} = -\frac{\lambda_{\text{DM}} v}{4} h S^2 - \frac{y_{\text{DM}}}{\sqrt{2}} h \bar{\chi} \chi - \frac{iy_{\text{DM}}^P}{\sqrt{2}} h \bar{\chi} \gamma_5 \chi. \quad (2.23)$$

For dark matter masses smaller than $m_h/2$, the decay channel $h \rightarrow SS/\bar{\chi}\chi$ is open, which produces the signal of Higgs invisible decays. As shown in ... (refer to Higgs section), the CEPC could reach a sensitivity of 0.31% (at 95% CL) on the branching ratio of Higgs invisible decays.² This provides considerable sensitivity to Higgs portal models with a dark matter mass below $m_h/2$, which can be competitive with the reaches of current and future direct detection experiments. To illustrate this, we make a comparison between

² Here we only include the Higgs invisible decay to BSM particles. If the SM decay $h \rightarrow ZZ \rightarrow \nu\bar{\nu}\nu\bar{\nu}$ is also included, the bound on the Higgs invisible branching ratio becomes 0.42% instead. See ... (refer to Higgs section) for more details.

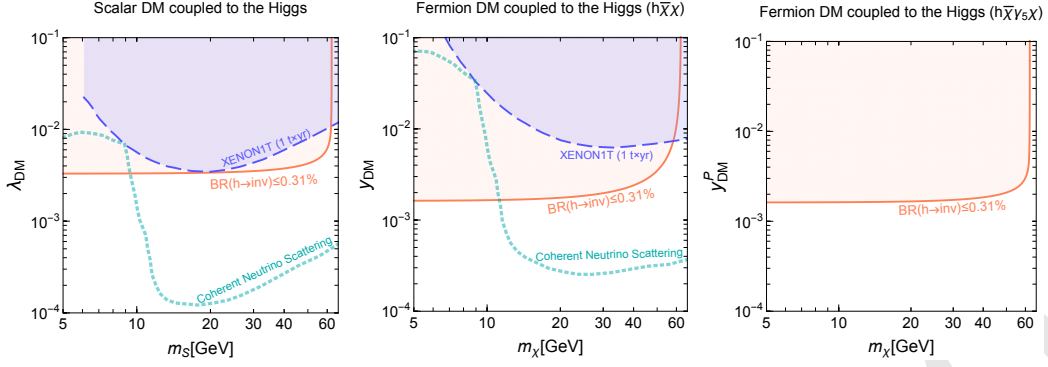

Figure 2.23: The *mass-coupling* plane for the Higgs portal models of Eq. (2.23) with a scalar DM (left), a Majorana fermion DM with a scalar coupling y_{DM} (middle) and a Majorana fermion DM with a pseudo-scalar coupling y_{DM}^P (right). The orange region is excluded by the invisible Higgs decay measurements at the CEPC, which constrains the branching ratio to be below 0.31% at 95% CL. The blue region is excluded by the most recent result from XENON1T [179]. The cyan dotted curve corresponds to the discovery limit set by the coherent-neutrino-scattering background, adapted from Ref. [180].

1 the reach of the CEPC and the one from the most recent result of XENON1T [179] in
 2 the *mass-coupling* plane for both the scalar and Majorana fermion DM. For the fermion
 3 DM, we consider two separate scenarios, one with a purely scalar coupling (y_{DM}) and
 4 the other with a purely pseudo-scalar coupling (y_{DM}^P), as shown in Eq. (2.23). We also
 5 assume that the correct relic abundance is achieved regardless of the model parameters.
 6 The results are shown in Figure 2.23. For the three scenarios in consideration, the CEPC
 7 bound on the Higgs invisible branching ratio, 0.31%, corresponds to a sensitivity to the
 8 Higgs-DM coupling of around 10^{-3} for DM mass smaller than $m_h/2$. For the scalar
 9 DM and Majorana fermion DM with coupling y_{DM} , this clearly surpasses the reach of
 10 XENON1T in this mass region. Even for future direct detection experiments, the reach
 11 could not go beyond the so-called “neutrino floor” (shown by the cyan dotted curve) due
 12 to the coherent-neutrino-scattering background [180], while the CEPC could still probe
 13 a significant part of the region below the neutrino discovery limit in the region $m_{\text{DM}} \lesssim$
 14 10 GeV. The pseudo-scalar coupling y_{DM}^P only produces a spin-dependent WIMP-nucleon
 15 interaction which is suppressed by the transferred momentum. The constraints on the
 16 fermion DM with y_{DM}^P from direct detection experiments are thus much weaker, while the
 17 reach of the CEPC still remains strong. In addition to these bounds, the CEPC’s sensitivity
 18 to fermionic Higgs portal dark matter through exotic Z boson decays has been discussed
 19 in Section 2.3.2.

20 In Figure 2.24, the CEPC coverage of Higgs portal dark matter models for both scalar
 21 and fermionic DM (y_{DM}) is converted to the corresponding spin-independent WIMP-
 22 nucleon cross-section, and compared to the coverage of direct detection experiments. In
 23 addition to the Xenon1T, the sensitivities of other experiments are also presented, includ-
 24 ing LUX (2017) [131] and PandaX-II (2017) [153], as well as future projections of Pan-
 25 daX4T with $5.6 t \times yr$ data [181], XENONnT with $20 t \times yr$ data [176], LUX-ZEPLIN
 26 (LZ) with $15.6 t \times yr$ data [182] and a xenon experiment with $200 t \times yr$ data [183]
 27 that corresponds to either DARWIN [154] or PandaX-30T. The current and future reaches
 28 of the LHC Higgs invisible decay measurements are also shown. The current bound,
 29 $\text{BR}(h \rightarrow \text{inv}) < 24\%$ at 95% CL, comes from the CMS analysis in Ref. [184]. The

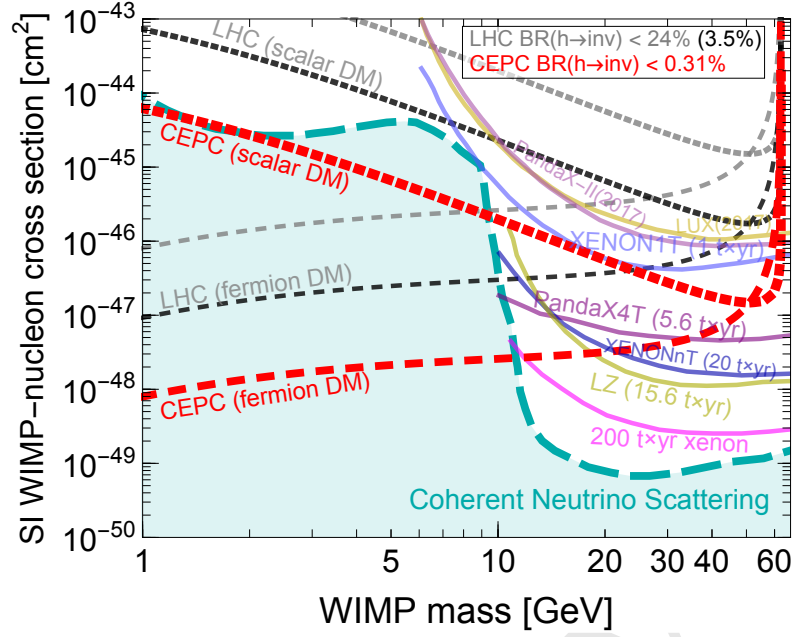

Figure 2.24: The sensitivity to the spin-independent WIMP-nucleon cross-section of current and future direct detection experiments, compared with the reach of Higgs invisible decay measurements at the LHC and CEPC in Higgs portal dark matter models. The direct detection limits are shown in solid lines, which include the most recent limits from LUX (2017) [131], PandaX-II (2017) [153], XENON1T [179] and future projections for PandaX4T [181], XENONnT [176], LZ [182] and a $200 t \times yr$ xenon experiment [183]. For the Higgs portal models, the dark matter is assumed to be either a scalar or a Majorana fermion with a scalar coupling. The red dotted curves show the limits from CEPC which corresponds to a invisible Higgs branching ratio of $BR(h \rightarrow inv) < 0.31\%$ at the 95% CL. The gray dotted curves correspond to $BR(h \rightarrow inv) < 24\%$, the current limit at the LHC [184], and the black dotted curves correspond to $BR(h \rightarrow inv) < 3.5\%$, the projected reach at HL-LHC from Ref. [186]. The cyan dashed curve corresponds to the discovery limit set by the coherent-neutrino-scattering background, adapted from Ref. [180].

1 projection by the ATLAS collaboration on the reach of $BR(h \rightarrow inv)$ at the HL-LHC
 2 is around 10% [185]. A study in Ref. [186] suggests that the reach could be improved
 3 to 3.5% with multivariate techniques. Both the current bound (24%) and the optimistic
 4 projection (3.5%) are plotted in Figure 2.24, which cover the possible range that the (HL-
 5)LHC could reach in the future. Finally, the cyan dashed curve corresponds to the pro-
 6 jected discovery limit from Ref. [180]. The region below this curve is inaccessible by
 7 direct detection experiments due to the coherent-neutrino-scattering background.

8 We see in Figure 2.24 that the sensitivity of the Higgs invisible decay measurements to
 9 the scalar DM and the Majorana fermion DM have different dependence on the mass. This
 10 is due to the following two reasons: first, the Higgs portal interaction with the scalar DM
 11 is a dimension-four operator, while the fermion one is of dimension five, which results in
 12 different mass dependence of the WIMP-nucleon cross-section; second, the Higgs decay
 13 rates are also different for the two cases, with $\Gamma(h \rightarrow SS) \propto (1 - 4m_S^2/m_h^2)^{1/2}$ and
 14 $\Gamma(h \rightarrow \bar{\chi}\chi) \propto (1 - 4m_\chi^2/m_h^2)^{3/2}$, a result of the s (p)-wave nature of the scalar (fermion).
 15 Nevertheless, for both scenarios, it is clear that the Higgs invisible decay measurements
 16 provide the strongest limit in the dark matter mass region below ~ 10 GeV. Not only do
 17 direct detection experiments become less efficient in this region due to the mass threshold,

the “neutrino floor” is also higher in this region, which sets the limit for the reach of direct detection experiments regardless of the size and length of the experiment. For dark matter masses in the region $10 \text{ GeV} \lesssim m_{\text{DM}} < m_h/2$, the sensitivity of the Higgs invisible decay measurements is comparable with that of direct detection experiments. In particular, for fermion DM the CEPC still has sensitivity in regions not covered by PandaX4T, XENONnT or LZ. On the other hand, a $200 t \times yr$ xenon experiment would fully surpass the reach of the CEPC in this region.

It bears emphasizing that, as mentioned earlier, the interaction term between the Higgs and the fermion DM in Eq. 2.22 is of dimension five. Such a nonrenormalizable operator indicates that the theory is only an effective one, and needs to be UV completed at a higher scale. More specifically, this operator can be generated by integrating out a heavy mediator that connects the Higgs and the fermion DM. The validity of the effective theory thus requires the mediator to be heavier than the scale of the interaction. For direct detection experiments, the momentum exchange is in the nonrelativistic regime, and is at the MeV level. For the Higgs decay, the interaction scale is at the order of the Higgs mass. Our results for the fermion DM are thus only valid if the mediator is at least as heavy as the Higgs boson.

Next, let us consider the kinetic mixing portal scenario, in which the hidden sector containing the dark matter is charged under a broken dark Abelian gauge symmetry, $U(1)_D$. The $U(1)_D$ could mix with the SM hypercharge $U(1)_Y$ through the operator

$$\frac{1}{2} \frac{\epsilon}{\cos \theta} Z_{D\mu\nu} B^{\mu\nu}, \quad (2.24)$$

where ϵ is the (dimensionless) kinetic mixing parameter and θ is the weak mixing angle. The heavy gauge boson associated with $U(1)_D$, often called the dark photon, could be searched for at a lepton collider in a variety of ways. First, the dark photon introduces two effects in the fit of precision electroweak observables: a shift in the Z mass observable and a shift of the Z couplings to SM fermions. The Z -pole program at CEPC could improve the sensitivity to electroweak observables by a factor of 10 compared to LEP and push the reach of ϵ down to $\sim 10^{-3}$ for $m_{Z_D} < 90 \text{ GeV}$ [187]. A more powerful way is to search for dark photons directly through the radiative return processes such as $e^+e^- \rightarrow \gamma Z_D \rightarrow \gamma \mu^+ \mu^-$. The search can be implemented by simply counting the number of events in the dimuon invariant mass spectrum in both the Z -pole and Higgs programs at CEPC. The direct searches probe $\epsilon \in (3 \times 10^{-4} - 10^{-3})$ depending on m_{Z_D} in the entire mass range up to 250 GeV that could be covered by CEPC [188], as illustrated in Figure 2.25. Another possible direct probe is the rare Z decay: $Z \rightarrow h_D Z_D \rightarrow Z_D Z_D Z_D$, where h_D is the dark Higgs. The reach of this search has been discussed in Sec. 2.3.2.

In the remainder of this subsection we will discuss a case study of a model with two renormalizable Standard Model–dark sector couplings, the Double Dark Portal model of Ref. [123]. This model rests on the observation that one possible origin for the mass of a $U(1)_D$ dark gauge boson is through the VEV of a dark Higgs scalar Φ carrying $U(1)_D$ charge. The $U(1)_D$ gauge boson kinetically mixes with the photon (with mixing parameter ϵ) while the dark Higgs Φ mixes with the Higgs through a $\lambda_{HP} |\Phi|^2 |H|^2$ quartic potential. A dark fermion χ with Dirac mass m_χ carrying $U(1)_D$ dark charge can play the role of dark matter. We denote the two scalar mass eigenstates of this model by H_0 (mostly Higgs) and S (mostly Φ) with mixing angle α . We denote the vector mass eigenstates by \tilde{Z}_μ (mostly the SM Z boson) and \tilde{K}_μ (mostly the dark photon). Both of the renormalizable

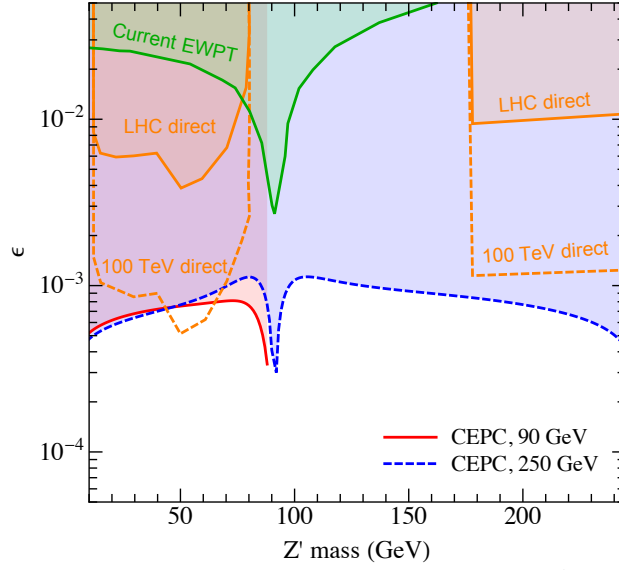

Figure 2.25: This figure illustrates CEPC’s capacity to probe dark photons via radiative return. The red-solid and blue-dashed lines show the 95% C.L. projected sensitivity to the (hypercharge) mixing parameter, ϵ , as a function of the dark photon’s mass, $m_{Z'}$. The red curve corresponds to $\sqrt{s} = 90$ GeV and $\mathcal{L} = 0.5 \text{ ab}^{-1}$ while the blue curve shows 250 GeV and 5 ab^{-1} . The figure is adapted from Refs. [187, 188].

Parameter	Signal process	Background (pb)	Signal region	
ϵ	$\tilde{Z}\tilde{K}$	$\tilde{Z} \rightarrow \bar{\ell}\ell, \tilde{K} \rightarrow \bar{\chi}\chi$	$\bar{\ell}\bar{\nu}\nu$ 0.929	$N_\ell \geq 2, m_{\ell\ell} - m_Z < 10 \text{ GeV},$ and $ m_{\text{recoil}} - m_{\tilde{K}} < 2.5 \text{ GeV}$
		$\tilde{Z} \rightarrow \bar{\ell}\ell, \tilde{K} \rightarrow \bar{\ell}\ell$	$\bar{\ell}\bar{\ell}\ell\ell$ 0.055	$N_\ell \geq 4, m_{\ell\ell} - m_Z < 10 \text{ GeV},$ and $ m_{\ell\ell} - m_{\tilde{K}} < 2.5 \text{ GeV}$
	$\tilde{A}\tilde{K}$	\tilde{K} inclusive decay	$\gamma f f$ 23.14	$N_\gamma \geq 1,$ and $ E_\gamma - (\frac{\sqrt{s}}{2} - \frac{m_{\tilde{K}}^2}{2\sqrt{s}}) < 2.5 \text{ GeV}$
		$\tilde{K} \rightarrow \bar{\ell}\ell$	$\gamma\bar{\ell}\ell$ 12.67	$N_\gamma \geq 1, N_\ell \geq 2, E_\gamma - (\frac{\sqrt{s}}{2} - \frac{m_{\tilde{K}}^2}{2\sqrt{s}}) < 2.5 \text{ GeV},$ and $ m_{\ell\ell} - m_{\tilde{K}} < 5 \text{ GeV}$
		$\tilde{K} \rightarrow \bar{\chi}\chi$	$\gamma\bar{\nu}\nu$ 3.45	$N_\gamma \geq 1, E_\gamma - (\frac{\sqrt{s}}{2} - \frac{m_{\tilde{K}}^2}{2\sqrt{s}}) < 2.5 \text{ GeV},$ and $\cancel{E} > 50 \text{ GeV}$
	$\tilde{Z}H_0$	$H_0 \rightarrow \tilde{K}\tilde{Z}$ with $\tilde{K} \rightarrow \bar{\chi}\chi, \tilde{Z} \rightarrow \bar{\ell}\ell$	$\bar{\ell}\bar{\ell}\ell\bar{\nu}\nu$ 1.8×10^{-5}	$N_\ell \geq 4, m_{\ell\ell} - m_Z < 10 \text{ GeV},$ and $ m_{\text{recoil}} - m_{\tilde{K}} < 2.5 \text{ GeV}$
$\sin \alpha$	$\tilde{Z}S$ $S \rightarrow \tilde{K}\tilde{K} \rightarrow 4\chi$	$\bar{\ell}\bar{\nu}\nu$ 0.87	$N_\ell \geq 2, m_{\ell\ell} - m_Z < 10 \text{ GeV},$ and $ m_{\text{recoil}} - m_S < 2.5 \text{ GeV}$	

Table 2.2: Double Dark Portal model: summary of the different vector + scalar and vector + vector production modes studied, along with the most salient cuts to identify the individual signals. All background processes include up to one additional photon to account for initial and final state radiation. Background rates are given for $\sqrt{s} = 250$ GeV, and visible particles are required to satisfy preselection cuts given in the main text of [123].

1 portal couplings lead to attractive discovery prospects at CEPC from a variety of channels
2 summarized in Table 2.2.

3 This model contains several couplings allowing transitions from the Standard Model
4 to the dark sector, proportional to an insertion of a mixing parameter. Vertices propor-
5 tional to α include H_0SS ; H_0H_0S ; $\tilde{K}_\mu\tilde{K}^\mu H_0$; and $\tilde{Z}_\mu\tilde{Z}^\mu S$. Vertices proportional to ϵ
6 include $\tilde{Z}_\mu\tilde{K}^\mu S$ and $\tilde{Z}_\mu\tilde{K}^\mu H_0$. If $4m_\chi < 2m_{\tilde{K}} < m_S$, then both the dark photon \tilde{K} and
7 dark Higgs S will dominantly decay invisibly, with visible branching ratios suppressed by

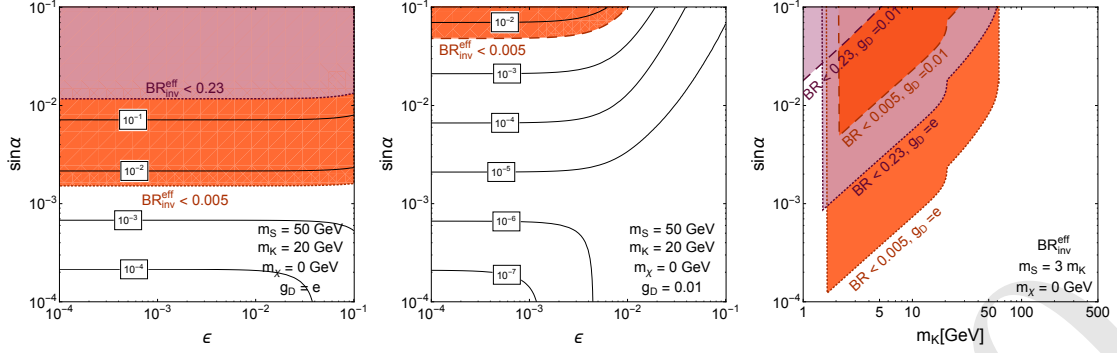

Figure 2.26: This figure shows the reach of CEPC to test the Double Dark Portal model [123] through invisible decay of the SM-like Higgs boson. **Left and center:** Rates for the invisible branching fraction of the 125 GeV Higgs in the $\sin\alpha$ vs. ϵ plane, setting $m_S = 50$ GeV, $m_K = 20$ GeV, and $g_D = e$ (left) and 0.01 (center). **Right:** Exclusion regions in the $\sin\alpha$ vs. m_K plane from the search for an invisible decay of the 125 GeV Higgs by ATLAS and CMS giving $BR_{inv} < 0.23$ [124, 125], and the projected reach from a future e^+e^- machine giving $BR_{inv} < 0.005$ [119–121, 189].

1 $e^2\epsilon^2/g_D^2$ and $\tan^2\alpha/g_D^2$ respectively. Hence, the Double Dark Portal model contains invis-
 2 ible Higgs decay modes $H_0 \rightarrow SS \rightarrow 4\tilde{K} \rightarrow 8\chi$ and $H_0 \rightarrow 2\tilde{K} \rightarrow 4\chi$, in addition to the
 3 possible exotic decay $H_0 \rightarrow \tilde{Z}\tilde{K}$ which is either partially visible or invisible depending
 4 on the \tilde{Z} decay channel. A precision measurement of the invisible branching fractions of
 5 the Higgs boson can significantly constrain the model, as summarized in Figure 2.26. Pre-
 6 cision observation of the Higgsstrahlung rate with $O(0.3\% - 0.7\%)$ accuracy [120–122]
 7 will constrain the scalar mixing angle at the level $\sin\alpha \lesssim 0.055 - 0.084$.

8 Direct searches for dark sector particles are possible in the channels $\tilde{Z}H_0$, $\tilde{Z}S$, $\gamma\tilde{K}$
 9 and $\tilde{Z}\tilde{K}$. The sensitivity of CEPC searches for these signals and comparisons to existing
 10 constraints from BaBar, LEP, and LHC are summarized in Figure 2.27. The $\tilde{Z}\tilde{K}$ final state
 11 can be searched for using the recoil mass in events containing $Z \rightarrow \ell^+\ell^-$. The radiative
 12 return process $e^+e^- \rightarrow \gamma\tilde{K}$ allows a search for events with a monochromatic photon
 13 together with $\tilde{K} \rightarrow \bar{\chi}\chi, \ell^+\ell^-$. The left panel of Figure 2.27 shows that searches with
 14 invisible \tilde{K} are more effective than those with $\tilde{K} \rightarrow \ell^+\ell^-$, due to the larger branching
 15 fraction. The figure also shows that a search for $H_0 \rightarrow \tilde{Z}\tilde{K}(\rightarrow \bar{\chi}\chi)$ is less effective.
 16 Finally, the right-hand panel of Figure 2.27 shows the reach of a search for the S -strahlung
 17 process $e^+e^- \rightarrow \tilde{Z}S$ in the mixing angle $\sin\alpha$. This search is exactly analogous to
 18 the previous search at LEP-II for a purely invisible decaying Higgs [117]. Improved
 19 sensitivity could be obtained by varying the \sqrt{s} of the collider to maximize the $\sigma(e^+e^- \rightarrow$
 20 $\tilde{Z}S)$ rate for the test S mass (see also Ref. [190]).

21 Portals with additional SM-sector physics

22 While the renormalizable SM portals are simple, they are not the only possibilities. Por-
 23 tals between the dark and visible sectors could be formed by additional particles with
 24 Standard Model gauge charges. These can offer interesting variations on the renormaliz-
 25 able portal. One example of such a portal is the leptonic Higgs portal [194]. This model
 26 includes an elementary scalar, S , which only couples to the SM leptons, $g_\ell S\bar{l}l$.³ Note that

³A variant of the model with S dominantly coupling to the muon and proton with tiny couplings to the electron and neutron might explain the proton radius puzzle and the muon anomalous magnetic moment discrepancy.

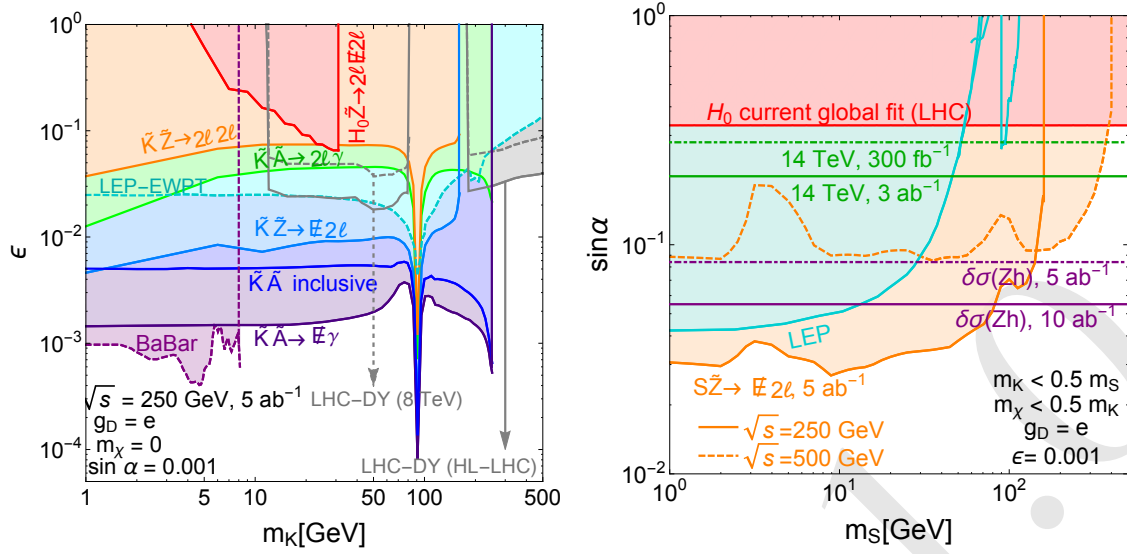

Figure 2.27: This figure shows the reach of CEPC to test the Double Dark Portal model [123] through searches for dark-sector particles. **Left:** Projected exclusion regions in the ϵ vs. m_K plane from multiple complementary searches of \tilde{K} production. Solid lines enclose expected exclusion regions with $\mathcal{L} = 5 \text{ ab}^{-1}$ of $\sqrt{s} = 250$ GeV e^+e^- machine data. Dashed lines indicate existing limits from the LEP $e^-e^+ \rightarrow \ell^-\ell^+$ contact operator search, the LEP electroweak precision tests (LEP-EWPT), the BaBar \tilde{K} invisible decay search (BaBar), and the LHC Drell-Yan constraints (LHC-DY). The 3 ab^{-1} HL-LHC projection for Drell-Yan constraints is also shown as a solid line. Note that m_K is approximately the $m_{\tilde{K}}$ mass eigenvalue. **Right:** Exclusion reach from the $\tilde{Z}S, \tilde{Z} \rightarrow \ell^+\ell^-$ search in the recoil mass distribution for invisible S decays in the $\sin \alpha$ vs. m_S plane using 5 ab^{-1} of e^+e^- data at $\sqrt{s} = 250$ GeV or 500 GeV. We also show comparisons to the current fit, $\sin \alpha < 0.33$ [118], future LHC projections of 0.28 (0.20) using 300 fb^{-1} (3 ab^{-1}) luminosity [119], and precision $\delta\sigma(Zh)$ measurements constraining 0.084 (0.055) using 5 ab^{-1} (10 ab^{-1}) [120–122]. We plot the excluded region from LEP searches for invisible low mass Higgs in the ZS channel in cyan [117, 191–193].

1 this operator is not SM gauge invariant and has to be UV completed. One possible simple
 2 UV completion is to couple a SM singlet to two Higgs doublets with one of the doublets
 3 only coupling to leptons and the other one only coupling to quarks. At a lepton collider,
 4 assuming that the couplings g_ℓ are proportional to the corresponding lepton mass, S could
 5 be produced in association with τ leptons, $e^+e^- \rightarrow \tau^+\tau^- + (S \rightarrow e^+e^-, \mu^+\mu^-, \tau^+\tau^-)$.
 6 Current beam dump and lepton colliders only probe m_S to a few GeV. CEPC could be
 7 capable of extending the sensitivity to much heavier S up to $m_S \sim 250$ GeV. In the par-
 8 ticular lepton-specific two Higgs doublet UV completion, the mixing between the singlet
 9 S and the higgs boson h leads to exotic Higgs decays such as $h \rightarrow SS \rightarrow 4\tau, 2\mu 2\tau$. For
 10 the 4τ final state, CEPC could test a branching fraction as small as 10^{-4} at 95% C.L., im-
 11 proving the sensitivity by three orders of magnitude compared to even the HL-LHC [195]!
 12 This is translated to a factor of 30 improvement in testing the coupling g_ℓ , fixing all the
 13 other parameters. Another similar possibility is a leptonic portal arising from some gauge
 14 bosons coupling to SM lepton-flavor currents [196].

15 In general, the dark matter portal models could give rise to exotic Higgs decays. A
 16 thorough review of the models leading to exotic Higgs decays and the status of LHC
 17 searches can be found in Ref. [112]. Supersymmetric exotic decays of the Higgs boson
 18 have been studied in Refs. [195, 197]. The potential of detecting exotic Higgs decays in
 19 14 different final states at CEPC has been presented in Ref. [195]. In every final state,

we expect at least one order of magnitude improvement in sensitivity compared to the HL-LHC and in quite a few channels, we expect 3-4 orders of magnitude improvement at CEPC. More details are discussed in Section 2.3.1.

A characteristic feature of many models that go beyond renormalizable portals is the possibility of new sources of flavor violation. For example, nonrenormalizable (dipole moment) operators could allow one SM fermion to decay to a dark photon and another SM fermion of different flavor, e.g. $\mu^\pm \rightarrow e^\pm \gamma_d$ or $t \rightarrow c \gamma_d$ [198]. Renormalizable completions of such models introduce new “messenger” particles that interact with the SM gauge groups and the dark photon. The induced flavor-violating decays could be searched for at CEPC.

Another possibility that could be tested at CEPC is flavor-violating dark matter in which dark matter couples dominantly to muons [199]. The dark multiplet contains a scalar and a vector-like fermion and couples to the muon through a Yukawa interaction. The neutral component of the scalar serves as the dark matter candidate. The interaction generates a loop correction to the $\gamma \mu^+ \mu^-$ and $Z \mu^+ \mu^-$ couplings that could be measured as deviations in the cross section of $e^+ e^- \rightarrow \mu^+ \mu^-$. Choosing the Yukawa coupling to be $O(1)$ means that a 2% precision measurement of the cross section can probe dark matter mass within 20 GeV around 120 GeV. Related models include flavored dark matter [200, 201], in which the dark matter particle carries flavor quantum numbers and has renormalizable contact interactions with the SM fields. In particular, electron-flavored dark matter could be produced copiously at a lepton collider associated with a photon if its mass is below ~ 120 GeV.

Effective theory

So far, our discussion of dark matter has been organized based on details of the model. However, one could also take a portal-agnostic or “model-independent” approach, simply searching for a generic signal like a single photon plus missing energy [202]. This could arise if DM is part of an electroweak multiplet, due to loops of the charged $SU(2)_L$ partners of dark matter and W bosons. It could also arise if completely new charged particles, independent of DM, exist and couple to DM. Results can be expressed simply in terms of effective operators, without committing to a particular UV completion. A variety of studies of such signals at $e^+ e^-$ colliders have been carried out, e.g. [203–206].

In an effective theory approach, such signals arise from dimension-7 effective operators coupling fermionic dark matter to pairs of SM gauge bosons. The operators that can be efficiently constrained by searches at CEPC are

$$\begin{aligned} \mathcal{L}_S &\supset \frac{1}{\Lambda_{\gamma\gamma}^3} \bar{\chi} \chi A^{\mu\nu} A_{\mu\nu} + \frac{1}{\Lambda_{\gamma Z}^3} \bar{\chi} \chi A^{\mu\nu} Z_{\mu\nu}, \\ \mathcal{L}_P &\supset \frac{1}{\Lambda_{\gamma\gamma}^3} \bar{\chi} i \gamma_5 \chi A^{\mu\nu} \tilde{A}_{\mu\nu} + \frac{1}{\Lambda_{\gamma Z}^3} \bar{\chi} i \gamma_5 \chi A^{\mu\nu} \tilde{Z}_{\mu\nu}, \end{aligned} \quad (2.25)$$

where the field strengths $A_{\mu\nu}$ and $Z_{\mu\nu}$ and their duals $\tilde{A}_{\mu\nu}$ and $\tilde{Z}_{\mu\nu}$ couple to the scalar (S) and the pseudoscalar (P) fermionic dark matter bilinears. The Λ factors in the coefficients represent the approximate mass scale of new physics (up to loop factors). Similar operators can also be written for the $SU(2)_L$ gauge fields, but the WW couplings may not be as efficiently probed by $e^+ e^-$ collisions at the Z pole.

The diphoton operator dominates processes with low momentum transfer because the photon is massless. It is much more stringently constrained by direct detection than its

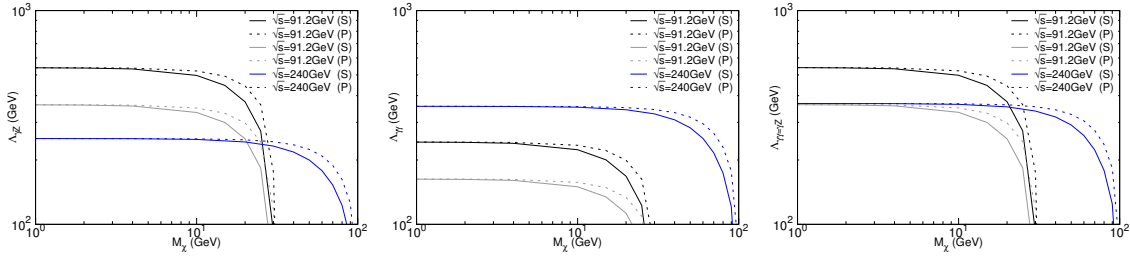

Figure 2.28: CEPC’s capacity to test whether dark matter couples to the SM photon and/or Z boson through the operators in Eq. (2.25). From left to right, the three panels correspond to pure $\Lambda_{\gamma Z}$ interaction, pure $\Lambda_{\gamma\gamma}$ interaction, and $\Lambda_{\gamma Z} = \Lambda_{\gamma\gamma}$ interaction. The various curves show CEPC’s 3σ projected sensitivity to the dark matter mass, m_χ , and the energy scale of new physics, Λ . The black, gray, and blue lines refer to $\sqrt{s} = 91.2$ GeV with 2.5 ab^{-1} , 91.2 GeV with 25 fb^{-1} , and 240 GeV with 5 ab^{-1} , respectively. The photon is required to have $|\eta| < 3$ and a $p_T > 25$ (35) GeV for 91.2 (240) GeV collision energy to optimize the sensitivity for a low m_χ . The solid lines are for a scalar operator and the dashed lines for the pseudoscalar case. The figure is adapted from Ref. [207].

1 DM- γZ and DM- ZZ counterparts. For DM lighter than half of m_Z , indirect detection using
 2 diffuse gamma rays is also more sensitive to the diphoton operator. Collider searches,
 3 on the other hand, can more effectively probe Z couplings. The high-luminosity Z -pole
 4 run at CEPC offers a unique opportunity to test the DM couplings to the Z boson. For a
 5 light DM mass, the resonantly produced $\bar{\chi}\chi\gamma$ system is best searched for in the monophoton
 6 + missing energy channel.

7 The proposed Z -pole runs’ prospective limits on effective DM- γZ and $\gamma\gamma$ couplings in
 8 the monophoton channel are studied in Ref. [207]. The major SM background, $e^+e^- \rightarrow$
 9 $\bar{\nu}\nu\gamma$, can be effectively controlled by optimizing the cut on the single photon’s p_T . The
 10 corresponding constraints on Λ are illustrated in Figures. 2.28 and 2.29. The best sensi-
 11 tivity is obtained for light dark matter mass. In case only one operator is considered, the
 12 projected sensitivity for $\Lambda_{\gamma Z}$ is 360 GeV and 540 GeV for 25 fb^{-1} (giga Z) and 2.5 ab^{-1}
 13 (tera Z) luminosities at the Z pole, respectively. In comparison, $\Lambda_{\gamma\gamma}$ is best probed at
 14 higher energy runs, and a limit of 360 GeV is obtained for a 5 ab^{-1} run at 240 GeV
 15 center-of-mass energy. In general, both $\Lambda_{\gamma Z}$ and $\Lambda_{\gamma\gamma}$ would be present and their relative
 16 size is model dependent.

17 Figure 2.29 further shows the direct and indirect detection limits together with CEPC’s
 18 constraint in the $\Lambda_{\gamma\gamma} - \Lambda_{\gamma Z}$ plane. For direct detection, we adopt the calculation of the
 19 spin-independent scattering rate via the scalar operator from Ref. [110, 212], which takes
 20 into account the diphoton exchange that dominates over γZ contributions. We choose
 21 benchmark DM masses at 4 and 10 GeV that are accessible to major nuclear recoil exper-
 22 iments. For indirect detection, we show the 95% C.L. constraint from the gamma ray line
 23 search at Fermi-LAT [211]. The nonrelativistic DM annihilation cross section into two
 24 photons ($\bar{\chi}\chi \rightarrow \gamma\gamma$) is dominated by $\Lambda_{\gamma\gamma}$ for m_χ below $m_Z/2$. The $\Lambda_{\gamma Z}$ dependence only
 25 emerges in a tiny correction as part of the $\bar{\chi}\chi \rightarrow \gamma(\gamma^*/Z^* \rightarrow \bar{f}f)$ process, and can be
 26 ignored at the DM masses shown.

27 The channel of monophoton + missing energy would also be sensitive to effective in-
 28 teractions between dark matter and electrons. In this case, the photon arises from initial
 29 state radiation. The related dimension-6 operators are

$$\mathcal{L}_{\chi e} = \frac{1}{\Lambda^2} \bar{\chi} \Gamma_\chi \chi \bar{e} \Gamma_e e, \quad (2.26)$$

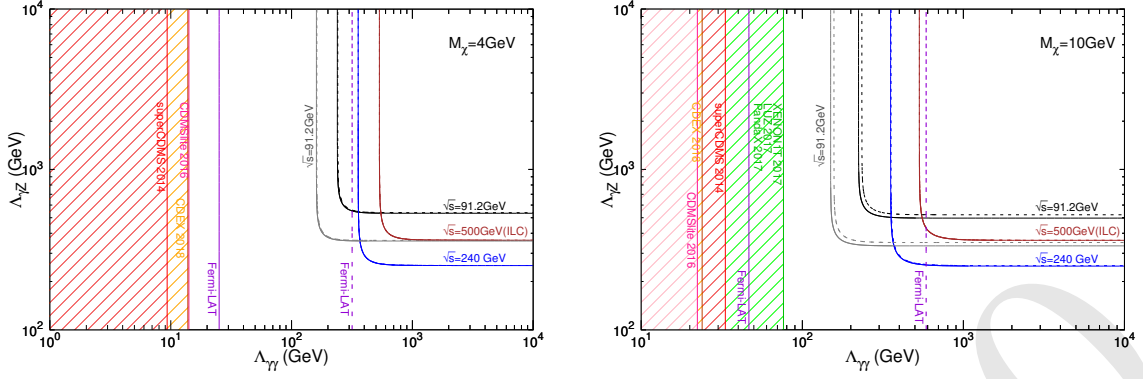

Figure 2.29: CEPC’s capacity to test whether dark matter couples to the SM photon and/or Z boson through the operators in Eq. (2.25). The left (right) panel shows a DM mass of $m_\chi = 4$ (10) GeV. The CEPC sensitivity is shown by the black, gray, and blue curves, which are defined in the caption of Figure 2.28. The brown line denotes the ILC 3σ sensitivity with an integrated luminosity of 500 fb^{-1} at $\sqrt{s} = 500 \text{ GeV}$ with cuts $10^\circ < \theta_\gamma < 170^\circ$ and $p_T(\gamma) > 90 \text{ GeV}$. Constraints from dark matter direct detection experiments are shown in red for SuperCDMS [208], orange for CDEX [209], pink for CDMSlite [210], and green for XENON1T [130], LUX [131], and PandaX [153] (which are in close proximity to each other). The purple-dashed line denotes the Fermi-LAT bound from the R3 region [211]. Note that the XENON1T/LUX/PandaX limit only appears in the $m_\chi = 10 \text{ GeV}$ case. The figure is adapted from Ref. [207].

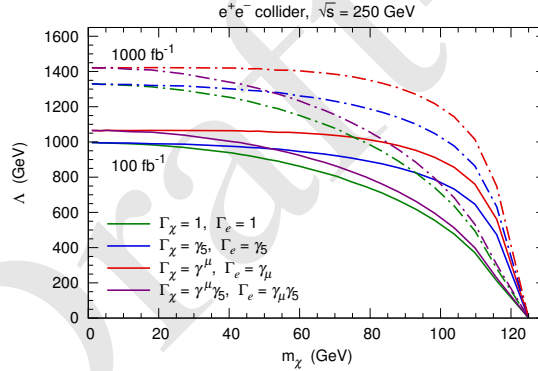

Figure 2.30: CEPC 3σ reach for several effective interactions between dark matter and electrons in the channel of monophoton + missing energy with integrated luminosities of 100 fb^{-1} and 1 ab^{-1} .

- 1 where $\Gamma_\chi, \Gamma_e \in \{1, \gamma_5, \gamma^\mu, \gamma^\mu \gamma_5, \sigma^{\mu\nu}\}$. The CEPC reach at 250 GeV center of mass energy
- 2 is demonstrated in the $m_\chi - \Lambda$ plane in Figure 2.30. For low masses, limits of $\sim 1.4 \text{ TeV}$
- 3 on Λ could be achieved with an integrated luminosity of 1 ab^{-1} .

- 4 An analogous approach is to search for a signal in the channel of mono- Z + missing
- 5 energy. This channel is sensitive to effective operators like

$$\mathcal{L}_{\chi Z} = \frac{1}{\Lambda^3} \bar{\chi} \chi Z^{\mu\nu} Z_{\mu\nu}. \quad (2.27)$$

- 6 Z bosons can be reconstructed by either two jets or two opposite-sign same-flavor leptons.
- 7 Figure 2.31 shows the CEPC reach in the $m_\chi - \Lambda$ plane at 250 GeV center of mass energy.
- 8 It is expected that the hadronic modes would provide a better sensitivity than the leptonic
- 9 modes.

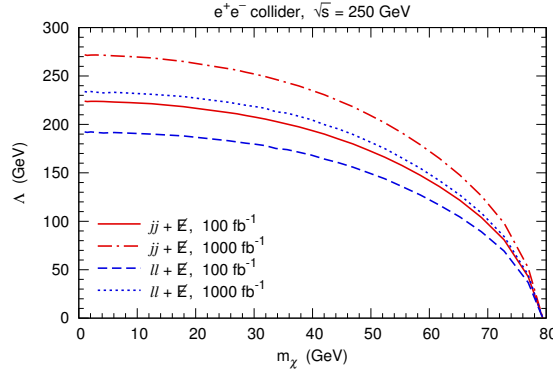

Figure 2.31: CEPC 3σ reach for the effective operator $\mathcal{L}_{\chi Z}$ in the channel of mono- Z + missing energy, adapted from [206]. Both the hadronic ($jj + \cancel{E}$) and the leptonic ($ll + \cancel{E}$) modes are presented with integrated luminosities of 100 fb^{-1} and 1 ab^{-1} .

2.3.4 Neutrino connection

Neutrino mass models

The CEPC is an excellent tool to study the physics of neutrino mass generation as a portal to unknown new physics during both the 240 GeV and the Z -pole runs. In this respect it can serve as a discovery machine for new physics that evades detection at hadronic colliders, including feebly coupled “hidden sector” extensions of the SM that can address fundamental questions in particle physics and cosmology.

The experimental observation of neutrino flavor oscillations [213, 214] indicates that neutrinos have a nonzero mass. Global fits to neutrino oscillation experiments (see e.g. [215, 216]) are sufficient to fix two neutrino mass-square differences and all mixing angles in the Pontecorvo-Maki-Nakagawa-Sakata matrix V_ν (assuming it to be unitary), while the absolute neutrino mass scale is constrained from cosmology to be in the sub-eV range (see e.g. [217]). These results raise a pair of pressing questions, namely why the neutrinos are so much lighter than all other fermions, and why the elements of the neutrino mass mixing matrix are so different from the quark mixing matrix.

Since the Standard Model of particle physics cannot account for nonzero neutrino masses in a renormalizable way, neutrino oscillations provide compelling experimental evidence for physics beyond the SM. While the origin of mass for the charged SM fermions (at least of the third generation) is well established by Higgs coupling measurements, the origin of mass for neutrinos is unknown and calls for a more fundamental theory of nature underlying the Standard Model. Moreover, neutrinos may be Majorana fermions [218], fundamentally different from their charged fermion counterparts, with consequences related to violation of lepton number that are potentially discoverable at colliders [219]. Lepton number violation may also be connected to an open question in cosmology, the baryon asymmetry of the universe (BAU), i.e., the tiny excess $\sim 10^{-10}$ [129] of matter over antimatter.

Under the assumption that the scale of new physics Λ associated with the mass of the lightest new particle involved in the generation of neutrino masses is much larger than the

1 typical energy $E_\nu \sim \text{MeV}$ in neutrino oscillation experiments,⁴ the neutrino oscillations
 2 can be described in the framework of Effective Field Theory (EFT). The relevant operators
 3 $\mathcal{O}_i^{[n]}$ have mass dimension $n > 4$, are suppressed by powers of Λ^{n-4} , and have Wilson
 4 coefficients $c_i^{[n]}$ that are matrices in flavor space. In this framework the smallness of the
 5 neutrino masses can be a consequence of any combination of the following reasons:

6 I) *High-Scale Seesaw Mechanism:* Large values of Λ automatically lead to small m_i .
 7 The three tree level implementations of the idea [222] are known as: Type-I See-
 8 saw [77, 78, 223–226], involving the SM plus right-handed neutrinos N ; Type-II
 9 Seesaw [226–230], involving the SM plus a scalar $SU(2)_L$ triplet Δ_L ; and Type-III
 10 Seesaw [231], involving the SM plus a fermionic $SU(2)_L$ triplet field Σ_L .

11 II) *Small numbers:* The $\mathcal{O}_i^{[n]}$ can remain small (for all values of Λ , including those acces-
 12 sible to CEPC) if the Wilson coefficients $c_i^{[n]}$ are small. In particular, if the neutrinos
 13 are Dirac particles their masses can be generated by the Higgs mechanism in exactly
 14 the same way as all other fermion masses with tiny Yukawa couplings. Tiny constants
 15 can be avoided e.g. when the neutrino interactions are created dynamically due to the
 16 spontaneous breaking of a flavor symmetry by flavons [232], or when the $\mathcal{O}_i^{[n]}$ are
 17 created radiatively (see e.g. [233–237]).

18 III) *Low-Scale Seesaw Mechanism:* A low scale Λ and $O(1)$ couplings between the SM
 19 and the new particles can be realized when symmetries give rise to cancellations in
 20 the neutrino mass matrix. For instance the $B - L$ symmetry of the SM can keep the
 21 $\mathcal{O}_i^{[n]}$ small for Λ below the TeV scale [238–240]. Specific models that implement
 22 this idea include the inverse [241–243] and linear [244, 245] seesaw, the Neutrino
 23 Minimal Standard Model [246, 247] and scale invariant models [248].

24 Here the terms "high scale" and "low scale" should be understood with respect to the
 25 CEPC collision energy; for values of Λ far above 240 GeV the EFT treatment intro-
 26 duced here to describe neutrino oscillation experiments can also be applied to CEPC phe-
 27 nomenology, while lower values imply that the new particles can be found at CEPC and
 28 should be described dynamically.

29 The original setting for the seesaw mechanism was grand unified theories, based on
 30 $SO(10)$ [224], and $SU(5)$ [223], as well as the minimal Left-Right (LR) symmetric model [77,
 31 78] and flavor/family symmetries [225]. The large scale of grand unification typically sets
 32 the mass scale Λ related to neutrino physics beyond the direct reach of colliders, although
 33 parts of multiplets may lie well below the GUT scale. For example, the minimal $SU(5)$
 34 model with the addition of a 24_F multiplet requires a light fermionic triplet in order for
 35 gauge couplings to unify [249, 250], motivating Type III Seesaw searches at the TeV
 36 scale. Other well known examples are for instance $B - L$ symmetry, additional "neu-
 37 trinophilic" Higgs doublets, and flavor symmetries. Such neutrino mass physics generally
 38 predicts the existence of new particles, which could at least in principle be discovered and
 39 studied at CEPC.

⁴Scenarios with $\Lambda < E_\nu$ are in principle feasible (see e.g. Refs. [220, 221] and references therein), but strongly constrained by the success of the high level of consistency in global fits to neutrino oscillation data that assume only three light neutrinos [215, 216].

1 Lepton number violation

2 If neutrinos are Majorana particles, the mechanism that generates their mass can mediate
3 lepton-number violating (LNV) processes at colliders if the scale Λ is below or near the
4 collision energy [219]. A variety of signatures arise in specific models for neutrino mass
5 generation.

6 **Type I Seesaw:** Observing the violation of lepton number from heavy neutrino mass
7 eigenstates (N_i) in the process $e^+e^- \rightarrow N\nu$ at lepton colliders is possible in princi-
8 ple due to the different kinematics of LNV and LNC processes, as was demonstrated
9 for the ILC [251]. In particular, for heavy neutrino N_i masses $M_i > m_Z$, the process
10 $e^+e^- \rightarrow \nu\ell jj$ is a promising signature at lepton colliders [252–254] and has been studied
11 specifically for CEPC [255]. The subleading production process for heavy neutrinos at
12 lepton colliders $e^+e^- \rightarrow N\ell^\pm W^\mp$ allows for same sign dileptons for $N \rightarrow \ell^\pm W^{(*)}$ and
13 $W \rightarrow$ hadrons [254].

14 It is worth pointing out, however, that LNV in the Type I Seesaw mechanism is sup-
15 pressed by the smallness of the light neutrino masses [239, 240]. It has been proposed that
16 the suppression of LNV may be alleviated by the process of heavy neutrino-antineutrino
17 oscillations, which occurs for heavy neutrinos with masses below the W boson's mass,
18 m_W , and with $U^2 < O(10^{-5})$ [256–258].

19 **Type II Seesaw:** The triplet scalar multiplet Δ_L in the Type II Seesaw contains three
20 complex fields, which are respectively neutral, singly charged, and doubly charged un-
21 der electromagnetism. The appealing feature of the model is the direct connection be-
22 tween neutrino masses and mixing parameters [259, 260] and the Majorana Yukawa ma-
23 trix $M_\nu = Y_\Delta \langle \Delta_L \rangle$, which may lead to charged lepton flavor violating signals [261].

24 Collider phenomenology is governed by the final state, which primarily depends on
25 the triplet's vacuum expectation value (VEV) [262] and the mass splittings of its compo-
26 nents [263]. If the masses are degenerate, the dominant decay mode is to leptons if the
27 triplet VEV is smaller than $\sim 10^{-4}$ GeV. This decay mode tests the flavor structure of
28 the neutrino mass matrix and leads to significant flavor-dependent bounds on the triplet
29 scalar mass up to 870 GeV at the LHC [264]. For the triplet VEV above $\sim 10^{-4}$ GeV, the
30 states decay to pairs of gauge bosons. A relatively small mass splitting, consistent with
31 precision electroweak constraints, triggers cascade decay modes [263] which produce soft
32 hadronic and multi-lepton final states [265]. Signal in the WW final state lead to weak
33 lower bounds on doubly charged scalars at the LHC, $m_{\Delta_L^{++}} \gtrsim 90$ GeV [266] or less, de-
34 pending on the lepton's flavor. Similarly, the cascade decays [263, 267] are not easy to
35 look for in hadronic colliders [268]; however, they may be observable in cleaner lepton
36 collisions [269].

37 At lepton colliders, the triplet components can be produced pair-wise through $e^+e^- \rightarrow$
38 $S\bar{S}$ (where $S = \Delta_L^0, \Delta_L^\pm, \Delta_L^{\pm\pm}$ are the various charged states in the triplet) or in single
39 production in association with two same-sign leptons $e^+e^- \rightarrow \Delta_L^{\pm\pm} \ell^\mp \ell^\mp$ [270, 271].
40 Another possible production mode is via vector-boson fusion $e^+e^- \rightarrow \ell \ell' S S'$, where
41 $\ell, \ell' = e^\pm, \nu$, as discussed in [272].

42 The doubly charged scalar bosons $\Delta_L^{\pm\pm}$ can couple to the electrons and positrons di-
43 rectly and contribute to Bhabha scattering in the t -channel [270, 273]. Running the lep-
44 ton colliders with same-sign beams may strongly enhance the production of the doubly
45 charged components in the s -channel [270, 274], see [275] for more recent work.

Left-Right Symmetric Model: The mixing of the SM Higgs doublet with the $SU(2)_R$ triplet Higgs that gives Majorana mass to right-handed neutrinos in the Left-Right Symmetric Model (LRSM) [276–279] may lead to LNV decays of $h \rightarrow NN$ [280]. The subsequent (and possibly displaced) decay of $N \rightarrow \ell^\pm jj$ can lead to a $\Delta L = 2$ LNV and potentially charged lepton flavor violating final state with two same sign-leptons and up to four jets. Due to the soft final states and displacement, such searches may be challenging at the LHC; however lepton colliders are much more suitable to detect such signals due to the absence of triggers and lower QCD backgrounds.

The presence of the mixing also allows for an enhanced production of the $SU(2)_R$ triplet $pp \rightarrow \Delta_R^0 \rightarrow NN$ at the LHC [281] with varying kinematics, depending on its mass. Moreover, one may be able observe a truly exotic Higgs decay with $h \rightarrow \Delta_R^0 \Delta_R^0 \rightarrow 4N$, where lepton number can be broken to up to four units [281]. The production at lepton colliders may proceed through the Higgs mixing $e^+e^- \rightarrow Z\Delta_R^0 \rightarrow NNZ$ for $\sqrt{s} \lesssim 100$ GeV and in the vector boson fusion (VBF) channel that produces the $NN\nu\bar{\nu}$ final state with lepton number violation and missing energy [281]. At $\sqrt{s} = 240$ GeV and $\mathcal{L} = 5$ ab, one may expect from a few hundred to more than 5000 NNZ events, depending on the masses of triplets and heavy neutrinos, as well as the Higgs-triplet mixing. Such events are essentially background free at lepton colliders because of the LNV final state, Z tagging, and characteristic displacement. Similarly, the quadruple production of N 's can proceed through the Higgs-triplet triple vertex with the potential of observing $O(10^4)$ events with the branching ratio of Higgs to $\Delta_R^0 \Delta_R^0$ at the 1% level.

Charged lepton flavor violation

Neutrino oscillations violate lepton flavor, which is transferred to the charged leptons via perturbation theory, such that the violation of the charged lepton flavor (cLFV) is a prediction [282]. This gives rise to a variety of distinctive processes that may be probed at CEPC.

Mixed flavor leptonic Higgs or Z boson decays: Observables at high energy that can measure cLFV are exotic decays of the Z boson into two charged leptons of different flavor, $Z \rightarrow e^\pm \mu^\mp, e^\pm \tau^\mp, \mu^\pm \tau^\mp$ [283, 284]. Also the decays of the Higgs boson into two charged leptons of different flavor are possible [285, 286]. The processes $h \rightarrow e^\pm \mu^\mp, e^\pm \tau^\mp, \mu^\pm \tau^\mp$ are lepton flavor violating Higgs decays that can be measured at CEPC for branching ratios as small as 1.2×10^{-5} to 1.6×10^{-4} [287].

Lepton universality violation in W boson decays: The branching ratios of the W bosons should be identical for the three different leptons⁵ due to the lepton flavor universality in the SM. Another probe of lepton universality is given by the decays of the τ lepton. Mixing of the active neutrinos with neutral fermions from the Type I or III Seesaw can lead to violations of lepton universality, see e.g. [289]. Charged scalar particles can affect the measurement of lepton-universality observables from W boson branching ratios [290].

Mixed flavor final states with and without resonance: In addition to exotic decays of Higgs, W , and Z bosons, an observable cLFV process at lepton colliders $e^+e^- \rightarrow \ell_\alpha^\pm \ell_\beta^\mp (+H)$. These processes receive contributions from electrically neutral scalars, for instance from

⁵Current LEP data features a branching $\text{Br}(W \rightarrow \tau\nu)$ that is larger than $\text{Br}(W \rightarrow \ell_{e,\mu}\nu)$ by $\sim 2\sigma$ [288].

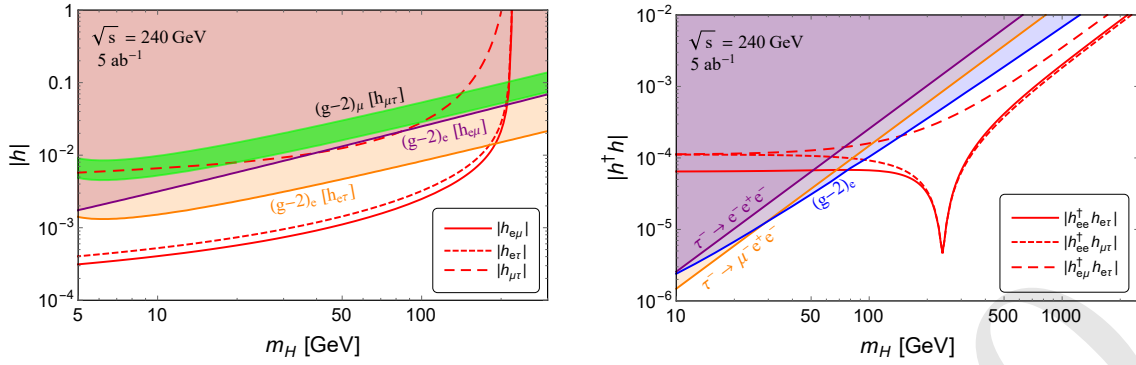

Figure 2.32: The CEPC’s ability to probe charged lepton-flavor violation (cLFV) is illustrated here as a sensitivity to the cLFV couplings, $h_{\alpha\beta}$ ($\alpha \neq \beta$), and the mass of a new, electrically-neutral scalar particle, m_H . Searches for $e^+e^- \rightarrow \ell_\alpha^\pm \ell_\beta^\mp H$ (left) and $e^+e^- \rightarrow \ell_\alpha^\pm \ell_\beta^\mp$ (right) at CEPC with $\sqrt{s} = 240$ GeV and $\mathcal{L} = 5 \text{ ab}^{-1}$ lead to projected sensitivities shown by the red curves (assuming 10 cLFV signal events). In the left panel the shaded regions are excluded by electron and muon $g - 2$, but the green band could explain the $(g - 2)_\mu$ discrepancy at the 2σ level. In the right panel the shaded regions are excluded by rare τ lepton decays, $\tau \rightarrow eee$ and $\tau \rightarrow ee\mu$. See the text and Ref. [291] for more details.

1 neutrino-philic Two Higgs Doublet models, Type II-based Seesaw models, $B - L$, or left-
 2 right symmetry. A dedicated study of such cLFV processes involving neutral scalars can
 3 be found in Ref. [291]. The most stringent constraints and the CEPC prospects in both the
 4 on-shell and off-shell modes are collected in Figure 2.32.

5 Higgs boson properties

6 The Higgs is a particularly sensitive probe of the mechanism of neutrino mass gener-
 7 ation. Higgs-based signatures motivated by neutrino mass models include anomalous
 8 Higgs production mechanisms; invisible or exotic Higgs decays; lepton-flavor-violating
 9 Higgs couplings; and modified Higgs couplings, all of which may be probed at CEPC.

10 **Anomalous Higgs boson production:** In models with heavy neutrinos, for heavy neutrino
 11 masses $M_i > m_h$ additional Higgs bosons can be produced from heavy neutrino decays
 12 in processes $e^+e^- \rightarrow Z^* \rightarrow N\nu \rightarrow H\nu\nu$. This can yield an enhancement of the SM
 13 mono-Higgs channel of up to $\sim 2\%$ when applying “standard” filters [292, 293]. The
 14 CEPC sensitivity via additional Higgs bosons from dedicated analyses is shown by the
 15 yellow line in Figure 2.33.

16 **Invisible Higgs boson decays:** The N_i can leave measurable imprints in precision mea-
 17 surements of the Higgs boson branching ratios. In the Type I Seesaw the Higgs boson
 18 can decay into a light and a heavy neutrino mass eigenstate when kinematically accessi-
 19 ble, which can account for up to 30% of the Higgs decays [294] without violating present
 20 constraints [295]. CEPC sensitivity to this scenario from searches for the Higgs invisible
 21 branching ratio, considering the precision from Ref. [122], is shown by the red line in
 22 Figure 2.33.

23 **Leptonic Higgs decays with cLFV or LNV:** As mentioned previously, cLFV decays also
 24 add loop-induced additional channels to the total Higgs decay width, and processes where

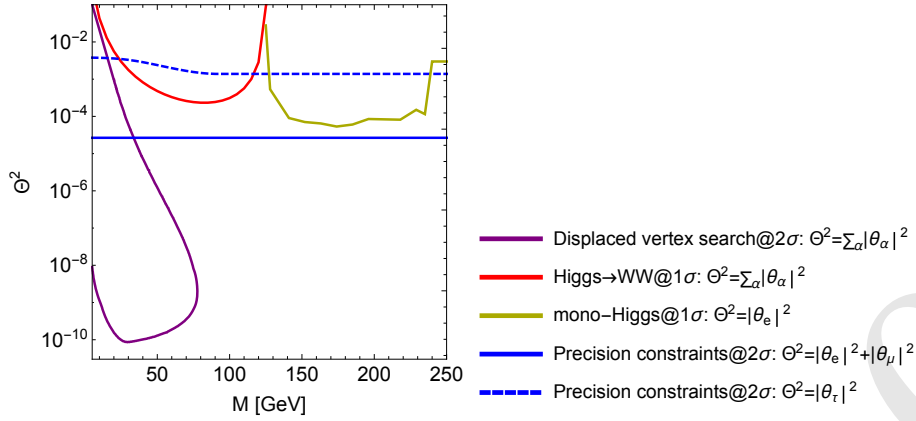

Figure 2.33: The CEPC’s ability to probe heavy sterile neutrinos is expressed as a projected sensitivity on the active-sterile mixing angle, Θ , and the sterile neutrino mass scale, M . The blue (solid and dashed) line denotes electroweak precision measurements [289, 294, 306, 307]. The purple line denotes displaced vertex searches [308] at the Z -pole run with an integrated luminosity of 10 ab^{-1} . The yellow and red lines stem from the measurements of Higgs production [292, 293] and decay [294] for an integrated luminosity of 5 ab^{-1} at $\sqrt{s} = 240 \text{ GeV}$.

- 1 the Higgs couples to two N_i can give rise to exotic LNV decay channels, all of which may
- 2 be extensively probed by the precision Higgs program at CEPC.

3 **Higgs decays into two N_i :** In $B - L$ and $L - R$ symmetric models, additional neutral
4 scalars can mix with the Higgs boson. This can give rise to additional decay channels into
5 two N_i , which can be observable depending on their masses and lifetimes. Such signatures
6 were studied in the context of LRSM [280, 281] and $B - L$ models [296, 297].

7 **Anomalous diphoton decays:** In the Type II Seesaw additional scalar particles couple di-
8 rectly to the Higgs boson, such that the singly and doubly charged components contribute
9 to the loop-induced coupling of the Higgs to two photons [263, 298–300]. Similarly, the
10 Type III Seesaw contains additional charged particles that can contribute to the Higgs-to-
11 diphoton branching ratio, see e.g. [301]. In the LRSM, the doubly charged component of
12 the $SU(2)_R$ triplet couples rather strongly to the SM Higgs, leading to an $O(100 \text{ GeV})$
13 lower bound on its mass [302] from similar radiative corrections.

14 **Modified Higgs self couplings:** In the Type I Seesaw the N_i with masses M_i of a few TeV
15 can modify the trilinear Higgs self-coupling up to 30 percent [303]. This modification is
16 also expected for the low-scale Type III Seesaw [304, 305]. CEPC sensitivity to the Higgs
17 self-coupling via radiative corrections to Higgsstrahlung provides a promising probe of
18 this effect.

19 **Modifications of electroweak precision observables**

20 Neutrino mass physics can modify the theory predictions for electroweak precision ob-
21 servables, which may be measurable even if the new mass scale is above the CEPC center-
22 of-mass energy. These can either occur due to virtual exchange of the new particles (which
23 may be represented by higher dimensional operators in an EFT approach [309, 310]) or
24 due to the production of new particles that mix with SM particles (e.g. with the active
25 neutrinos or the SM Higgs boson).

1 In the context of the Type I Seesaw mechanism the mixings $\theta_{ai} = vY_{ai}/M_i$ of n_s heavy
 2 right handed neutrinos with the SM neutrinos leads to an effective violation of unitarity
 3 in the 3×3 mixing matrix V_ν , which is a submatrix of the $(3 + n_s) \times (3 + n_s)$ leptonic
 4 mixing matrix \mathcal{U} [289, 311–313]. This affects all the electroweak precision observables.
 5 Such tests are mostly independent of the heavy neutrino masses M_i , and they test different
 6 combinations of the active-sterile mixing parameters [289, 294, 306, 307]. We show the
 7 corresponding possible sensitivity of CEPC by solid and dashed blue lines in Figure 2.33,
 8 considering a total integrated luminosity of 0.1 ab^{-1} . In addition to the modified precision
 9 observables, one also expects violations of lepton universality and (apparent) violations
 10 of the unitarity of the Cabibbo-Kobayashi-Maskawa matrix [289, 295, 314–317].

11 In the context of Type II Seesaw, the electroweak precision observables are affected
 12 both by the triplet VEV, as well as by the mass splittings [263] that enter the oblique T
 13 parameter. In the minimal LRSM, this splitting is predicted to be large and leads to a
 14 lower bound on the entire $SU(2)_L$ triplet multiplet [302].

15 Displaced secondary vertices

16 The mechanism of neutrino mass generation can also give rise to truly exotic signatures in
 17 the form of long-lived particles whose decays produce displaced secondary vertices. Such
 18 displaced vertices are often poorly constrained at the LHC due to trigger and background
 19 limitations, whereas CEPC can provide significant sensitivity.

20 **Single displaced vertex in Type I Seesaw:** For masses below the W bosons's mass, m_W ,
 21 the lifetime of N_i scales as $\tau_{N_i} \propto |\sum_a |\theta_{ai}|^2|^{-2} G_F^{-2} M_i^{-5}$ and their decays give rise to a
 22 visibly displaced secondary vertex in a large part of the allowed parameter space. Dis-
 23 placed vertex signatures have been studied in detail for the case of the Type I Seesaw, and
 24 the CEPC specific results from Refs. [258, 308] are shown in Figure 2.33 by the purple
 25 line. It is worth noting that with a longer Z -pole run the sensitivity for $M_i < m_Z$ can be
 26 significantly increased, see Figure 2.34. The sensitivity of a standard detector could be
 27 increased with additional detectors of the MATHUSLA [318, 319] or FASER [320] type.

28 **Long lived neutral scalars:** Due to mixing with the Higgs boson, the electrically neutral
 29 scalars in gauged $U(1)_{B-L}$ [321] or the neutral scalar from $SU(2)_R$ [322] can decay via
 30 the SM Yukawa couplings into the SM fermions. For masses in the GeV range, the result-
 31 ing proper lifetimes can easily be $O(1 \text{ cm})$, such that their decays give rise to displaced
 32 secondary vertices.

33 **Multiple displaced vertices:** Pair production of N in exotic Higgs decays may lead to
 34 two displaced vertices, each containing a lepton and two jets at parton level, as pointed
 35 out in the context of LRSM [280, 281] and models with $B - L$ symmetry [296, 297]. Rare
 36 exotic decays of the SM-like Higgs boson to a pair of triplets with subsequent decay to 4
 37 N s leads to up to four displaced vertices with rather soft final states, for which the CEPC
 38 is likely to be much better suited than the LHC.

39 Similarly, the associated production of the scalar triplet at $e^+e^- \rightarrow Z^* \rightarrow Z\Delta_R^0$ leads
 40 to two displaced vertices when $\Delta_R^0 \rightarrow NN$, while Z decay gives additional prompt lep-
 41 tons/jets or missing energy.

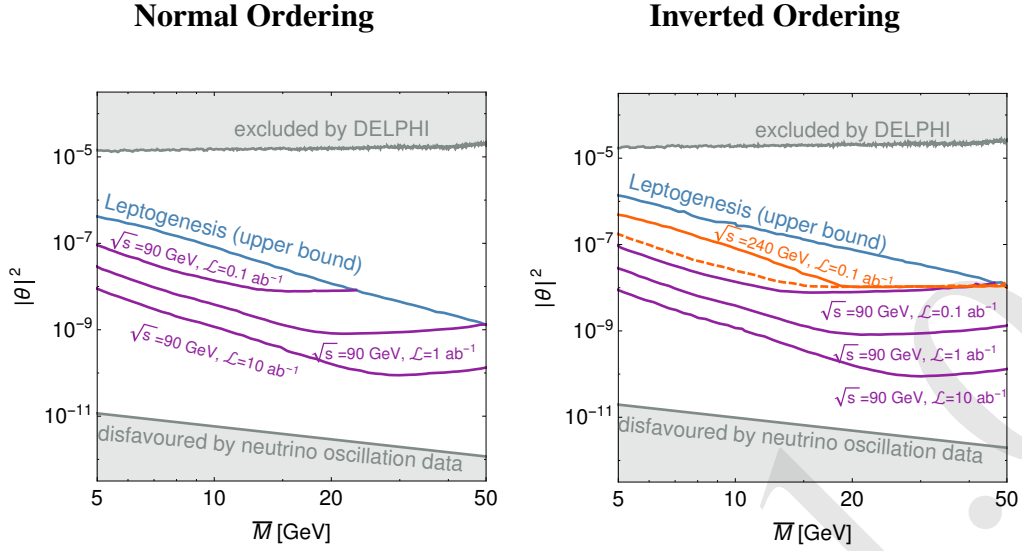

Figure 2.34: CEPC’s capacity to test models of leptogenesis. The parameter space for a minimal Type I Seesaw model with $n_s = 2$ is shown; the two sterile neutrino masses, M_1 and M_2 , are combined to form $\bar{M} = (M_1 + M_2)/2$ (with $|M_2 - M_1|/(M_2 + M_1) < 0.1$), and θ represents the active-sterile mixing angle. Models in the parameter space below the blue line are consistent with the observed baryon asymmetry of the universe through leptogenesis. Models above the orange lines are tested by CEPC at $\sqrt{s} = 240$ GeV, which is expected to observe at least four displaced vertex events. Models above the purple lines are probed by CEPC at the Z pole. The grey areas are ruled out by the DELPHI experiment [323, 324] (top) and current neutrino oscillation data (bottom). The figure is based on Ref. [258]. Note that for $n_s = 3$ heavy neutrinos, the “leptogenesis” upper bound is expected to be much higher [325] and practically identical to the DELPHI constraint, so that CEPC at 240 GeV can enter the cosmologically interesting parameter region for both hierarchies.

1 Extra gauge bosons

2 Extended theoretical frameworks generally predict more and stronger signals from heavy
3 neutrinos. In particular the gauged $B - L$ symmetry, which contains an extra Z' gauge
4 boson, may give rise to a modified rate for the processes $e^+e^- \rightarrow \ell^+\ell^-$ at lepton collid-
5 ers [326–328].

6 The Left-Right symmetric model contains the parity-symmetric W_R and Z_{LR} charged
7 and neutral gauge bosons. The charged bosons are strongly constrained by B and K
8 meson mixing and CP-odd observables, (see e.g. [329]), as well as the neutron electric
9 dipole moment constraints [330], with current bounds in the 3 TeV range. The neutral
10 gauge boson Z_{LR} is typically heavier in minimal LR models.

11 In many instances, the LHC searches are catching up with flavor limits. In particular the
12 ‘golden channel’ $pp \rightarrow W_R \rightarrow \ell N$ [331] features a dynamic parameter space [332] that
13 ranges from prompt N production to merged neutrino jets [333–335], displaced vertices
14 [336, 337] and a single prompt lepton with missing energy, where current bounds range up
15 to 5 TeV, see [337] for the complete coverage of parameter space of W_R and N masses.

16 Additional gauge bosons can give rise to additional production mechanisms for N_i that
17 are not suppressed by small Yukawa couplings, but possibly by the large gauge boson
18 masses or their small couplings to the SM, see e.g. [296].

1 Leptogenesis

2 *Leptogenesis* refers to the idea that a matter-antimatter asymmetry is initially generated in
 3 the lepton sector [338] and then transferred into a baryon asymmetry via sphaleron pro-
 4 cesses [339]. Leptogenesis provides an explanation for the observed *baryon asymmetry of*
 5 *the universe* (BAU), i.e., the tiny excess $\eta_B \sim 10^{-10}$ [129] of matter over antimatter in the
 6 early universe over that formed the origin of the baryonic matter in the universe after mu-
 7 tual annihilation of all other particles and antiparticles, see e.g. [340]. Thus leptogenesis
 8 connects one of the deepest mysteries in cosmology to the properties of neutrinos.

9 **Motivation.** Global fits to present neutrino oscillation data prefer charge-parity (CP)
 10 violation in the leptonic sector at the 2 to 2.5 σ level, see [215, 216]. This CP violation
 11 in the leptonic sector may be related [341] to the observed BAU.

12 When the scale of new physics Λ is above the collision energies at CEPC, it is impos-
 13 sible to discover the new particles responsible for the generation of the BAU via direct
 14 production. However, observing a combination of LNV and cLFV signatures at scales
 15 accessible to CEPC could still rule out such "high scale leptogenesis" scenarios because
 16 particles with LNV interactions near the electroweak scale could wash out baryon asym-
 17 metries that were produced at high scales [342, 343].

18 If, in contrast, Λ is within reach of CEPC, one can directly probe the mechanism of
 19 leptogenesis by studying the properties of the new particles [344]. One of the best studied
 20 scenarios that accommodates leptogenesis is based on the low-scale Type I Seesaw model.
 21 The Yukawa couplings Y_{ai} that couple the right-handed neutrinos N_i to the Higgs and
 22 the left-handed neutrinos ν_{La} in general are complex and are a potential source of CP
 23 violation. Hence, the N_i may be the common origin on neutrino masses and baryonic
 24 matter in the universe.

25 If the mass range M_i is around or below the collider-accessible TeV scale, leptogenesis
 26 can proceed in two different ways. For M_i above the electroweak scale, the BAU can be
 27 generated during the freeze-out and decay of the N_i [345] ("freeze-out scenario"). For
 28 masses below the electroweak scale the BAU can be generated in CP -violating oscilla-
 29 tions [247, 346] and Higgs decays [347] during the N_i production ("freeze-in scenario").
 30 The latter effectively also describes leptogenesis in the *Neutrino Minimal Standard Model*
 31 (ν MSM) [246, 247], a complete model where a third heavy neutrino composes the Dark
 32 Matter [79, 80] and does not contribute significantly to neutrino mass generation and lep-
 33 togenesis due to strong observational constraints [348]. Due to its minimality, part of the
 34 relevant parameter space of this model is in principle fully testable at colliders [349, 350],
 35 and significant fractions of the parameter space can be probed with CEPC [258]. For M_i
 36 below the electroweak scale, this analysis could be done with an accuracy on the percent
 37 level at the Z pole with 10 ab^{-1} [258].

38 **Lepton-number violation.** Lepton number violation is a crucial ingredient of any lepto-
 39 genesis scenario. Typical signatures at CEPC may involve same sign dilepton final states,
 40 either in prompt or displaced decays. An observation of such processes in all three SM
 41 flavors or a combination of LNV in some channel and different cLFV signatures could
 42 potentially falsify high scale leptogenesis scenarios [342, 343].

43 Many low scale models rely on an approximate lepton-number conservation to explain
 44 the smallness of the neutrino masses in the regime of coupling constants that is accessi-
 45 ble to CEPC [238–240], which parametrically suppresses the rate of LNV processes in

prompt decays. For particles with quasi-degenerate masses and comparable lifetimes, as they e.g. appear in resonant leptogenesis scenarios of the ν MSM, it has been proposed that this suppression may be overcome by the long time that they have to undergo coherent oscillations within the detector [256, 257, 351]. Since the amount of lepton number violation is proportional to the mass splitting, indirect measurements may be possible from a comparison of the rates for lepton number violating and conserving processes [256, 351] or by observing heavy neutrino-antineutrino oscillations in the detector [257] in displaced vertex searches at CEPC [258]. The reach of such searches at CEPC in the minimal seesaw model is shown in Figure 2.34, see also Figure 2.33.

Lepton-flavor violation. Measurements of cLFV are crucial to test high scale leptogenesis models at CEPC, because an efficient washout of the asymmetries in all flavors at temperatures above the electroweak scale is crucial to rule out such scenarios as the origin of the BAU [343].

Low scale leptogenesis scenarios typically rely on flavor effects and therefore tend to make predictions for the rates of cLFV. In the minimal Type I Seesaw with $n_s = 2$ (or the ν MSM), leptogenesis significantly restricts the flavor mixing pattern of heavy neutrinos N_i with experimentally accessible mixing angles [350]. The accuracy on the percent level at which the flavor mixing pattern can be probed in displaced vertex searches with 10 ab^{-1} at the Z pole are sufficient to probe large fractions of the parameter region for which heavy neutrinos can be discovered.

Displaced decays from long lived heavy neutrinos. For heavy neutrino masses below the electroweak scale, where leptogenesis proceeds in the "freeze in" manner, the N_i couplings should be comparably small to avoid a complete washout of the BAU in the early universe ($|\theta_{ai}|^2 < 10^{-8} \times (10 \text{ GeV}/M_i)$ [352], where larger values can be allowed due to strong hierarchies in their couplings to individual SM flavors [325]). Hence, most of the parameter space of active-sterile neutrino mixing and masses that is compatible with low scale leptogenesis in this scenario gives rise to long lifetimes of the heavy neutrino mass eigenstates, which can be found with high sensitivity via displaced vertex searches at CEPC. The reach of such searches at CEPC is compared to the parameter region where leptogenesis is feasible in the minimal seesaw model in Figure 2.34.

2.3.5 Extended Higgs sector

In many extensions of the Standard Model, the Higgs boson is embedded in a larger Higgs sector. Searching for new Higgs bosons is an important experimental target with a high priority. One of the most straightforward and well-motivated extensions is the two-Higgs-doublet model (2HDM) [353], in which there are five massive spin-zero states in the spectrum (h, H^0, A^0, H^\pm) after electroweak symmetry breaking. Extensive searches for BSM Higgs bosons have been carried out, especially at the LHC [22, 354–364]. Null results in searches to date imply that either the non-SM Higgs bosons are much heavier and essentially decoupled from the SM, or the lightest CP-even Higgs boson mimicks the SM Higgs by accident or symmetry while non-SM Higgs bosons are light as well [365–367]. In either case, it would be challenging to observe those states directly in experiments.

Complementary to the direct searches, precision measurements of the SM parameters and Higgs properties could also provide useful probes of new physics. High-precision measurements at future Higgs factories with about 10^6 Higgses, and Z -pole measurements

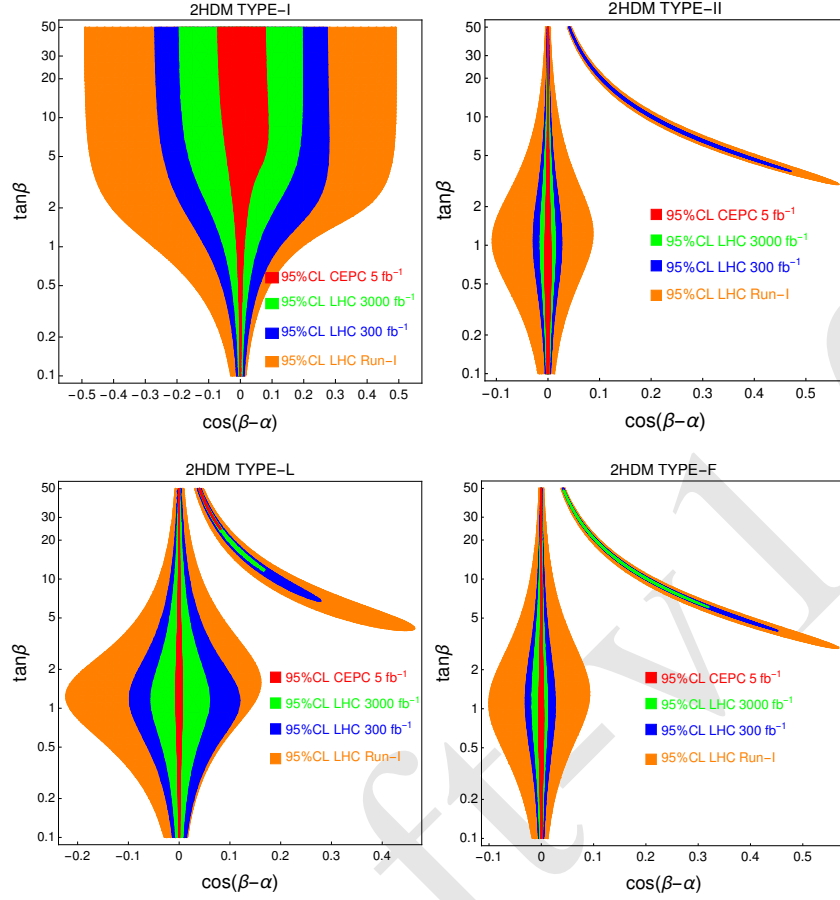

Figure 2.35: This figure shows the CEPC’s capacity to test for new physics in the Higgs sector and its dramatic improvement over existing and projected limits from the LHC. Shaded regions show the viable parameter space assuming that the future measurements agree with SM predictions. The panels show the four types of two-Higgs-doublet models (2HDM). The special “arm” regions for the Type-II, L, and F 2HDMs are the wrong-sign Yukawa regions. Plots are taken from Ref. [20].

1 with $10^{10} - 10^{12}$ Z bosons [140, 368–371] would invariably shed light on new physics
 2 associated with the electroweak sector such as an extended Higgs sector. There is an
 3 extensive literature on the effects of the heavy Higgs states on the SM Higgs couplings,
 4 e.g. [20, 353, 372–380]. Identifying the light CP-even Higgs h to be the experimentally
 5 observed 125 GeV Higgs, the couplings of h to the SM fermions and gauge bosons receive
 6 two contributions: tree-level values, which are controlled by the mixing angles α of the
 7 two CP-even Higgses and $\tan\beta$, ratios of the vacuum expectation values of two Higgs
 8 doublets, $\tan\beta = v_1/v_2$, and loop corrections from heavy Higgses running in the loop.
 9 Of particular interest is the “alignment limit” with $\cos(\beta - \alpha) = 0$, in which the light CP-
 10 even Higgs couplings are identical to the SM ones at the tree-level, regardless of the other
 11 scalars’ masses. Loop corrections, however, could lead to deviations of the couplings of
 12 h to the other SM particles, even in the alignment limit.

13 We first consider tree-level corrections. The allowed region at 95% C.L. in the $\cos(\beta -$
 14 $\alpha)$ vs. $\tan\beta$ plane for various types of 2HDM (depending on how the two Higgs doublets
 15 are coupled to the quarks and leptons) are shown in Figure 2.35 including only tree-level
 16 effects. This is obtained via a global fit to the Higgs rate measurements at the LHC as well

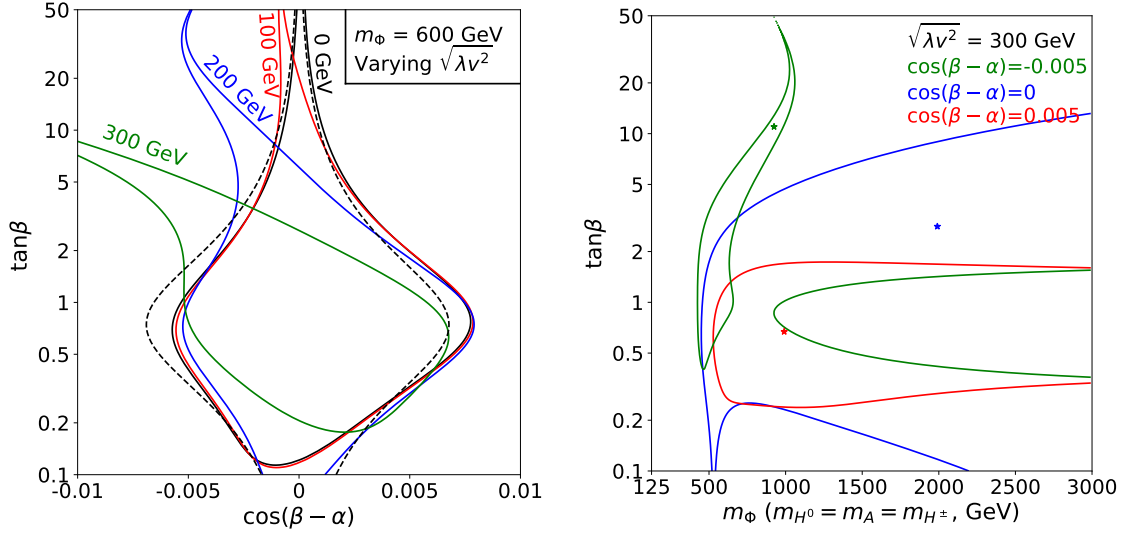

Figure 2.36: The constraining power of the CEPC precision measurements are illustrated here using the Type-II 2HDM parameter space. Assuming that no deviation from SM predictions are observed, the allowed regions of parameter space (at 95% C.L.) are enclosed by the curves with the same style. These curves are calculated by a fit including both the tree-level and the loop correction to the SM Higgs couplings. **Left:** The left panel is in the $\cos(\beta - \alpha)$ vs. $\tan\beta$ plane, with $m_A = m_H = m_{H^\pm} = m_\Phi = 600$ GeV. The parameter $\sqrt{\lambda v^2}$ is set to be 0 (black solid), 100 (red solid), 200 (blue solid), and 300 GeV (green solid). The global fit result with tree-level only correction is represented by the dashed black lines for comparison. **Right:** The right panel is in the m_Φ vs. $\tan\beta$ plane with $\sqrt{\lambda v^2} = 300$ GeV. The values of $\cos(\beta - \alpha)$ are chosen to be -0.005 (green), 0 (blue), and 0.005 (red). The stars represent the corresponding best fit points. These plots are taken from Ref. [380].

1 as CEPC, assuming that no deviation to the SM values is observed at future measurements.
 2 From the figure, one can see that $\cos(\beta - \alpha)$ in all four types is tightly constrained at both
 3 small and large values of $\tan\beta$, except for Type-I, in which constraints are relaxed at large
 4 $\tan\beta$ due to suppressed Yukawa couplings.

5 To fully explore the Higgs factory potential, both the tree-level deviation and loop cor-
 6 rections to the SM Higgs couplings need to be taken into account. Figure 2.36 shows the
 7 global fit results to all CEPC Higgs rate measurements in the Type-II 2HDM parameter
 8 space, including both tree level and loop corrections. Degenerate heavy Higgs masses
 9 $m_A = m_H = m_{H^\pm} = m_\Phi$ are assumed so that the Z -pole precision constraints are auto-
 10 matically satisfied. The left panel is in the $\cos(\beta - \alpha)$ vs. $\tan\beta$ plane with regions enclosed
 11 by curves allowed if no deviation from the SM prediction is observed. Black, red, blue,
 12 and green curves are for $\sqrt{\lambda v^2} = \sqrt{m_\Phi^2 - m_{12}^2}/s_\beta c_\beta = 0, 100, 200,$ and 300 GeV, re-
 13 spectively. The global fit result with tree-level only corrections is shown by dashed black
 14 lines for comparison. In all scenarios, $|\cos(\beta - \alpha)|$ is typically constrained to be less than
 15 about 0.008 for $\tan\beta \sim 1$. For smaller or larger values of $\tan\beta$, the allowed range of
 16 $\cos(\beta - \alpha)$ is significantly reduced. Loop effects from the heavy Higgses tilt the allowed
 17 $\cos(\beta - \alpha)$ towards negative values, especially when $\tan\beta$ is large.

18 The right panel of Figure 2.36 shows the allowed region at 95% C.L. in the m_Φ vs. $\tan\beta$
 19 plane, with $\cos(\beta - \alpha) = -0.005$ (green), 0 (blue), and 0.005 (red). In the alignment limit
 20 with $\cos(\beta - \alpha) = 0$, the mass of the heavy Higgses $m_\Phi > 500$ GeV is still allowed when
 21 $\tan\beta \lesssim 10$. Once deviating away from the alignment limit, the constraints on the heavy

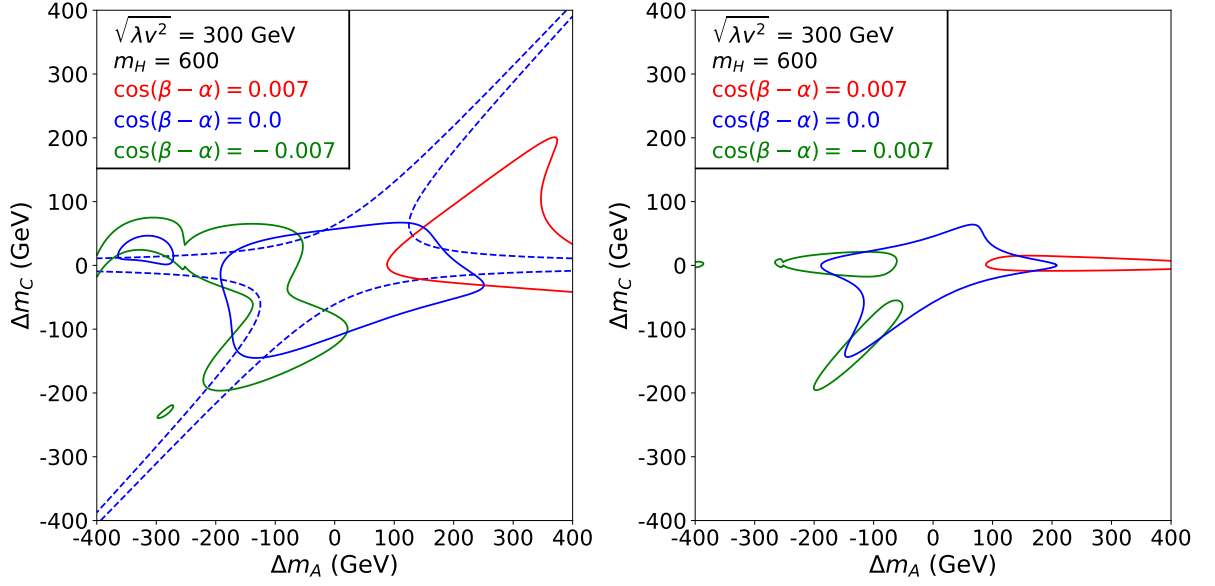

Figure 2.37: Allowed regions of $\Delta m_A = m_A - m_H$ and $\Delta m_C = m_{H^\pm} - m_H$ at 95% C.L., for different choices of $\cos(\beta - \alpha)$. **Left:** Higgs precision constraints for $\cos(\beta - \alpha) = 0.007$ (solid red), 0 (solid blue), and -0.007 (solid green) and Z -pole constraints (dashed blue). Note that the Z -pole constraints are the same for $\cos(\beta - \alpha) = 0.007, 0,$ and -0.007 . **Right:** constraints from combining both the Higgs and Z pole measurements for $\cos(\beta - \alpha) = 0.007$ (solid red), 0 (solid blue), and -0.007 (solid green). Plots are taken from Ref. [380]. Add GeV to $m_H = 600$.

1 Higgs mass get tighter. The reach in the heavy Higgs mass and couplings at future Higgs
 2 factories can be complementary to the direct search limits at the LHC [22, 354–364],
 3 especially at intermediate values of $\tan \beta$.

4 Going beyond the degenerate mass case, both the Higgs and Z -pole precision mea-
 5 surements are sensitive to the mass splitting between the charged and neutral Higgses,
 6 as well as the splitting between the neutral ones. Figure 2.37 shows the allowed region
 7 of $\Delta m_A = m_A - m_H$ and $\Delta m_C = m_{H^\pm} - m_H$ at 95% C.L., for different choices of
 8 $\cos(\beta - \alpha)$. The Higgs and Z -pole precision constraints are presented separately in the left
 9 panel while the combined constraints are shown in the right panel, with $m_H = 600$ GeV
 10 and $\sqrt{\lambda v^2} = 300$ GeV. For the Higgs precision fit, in the alignment limit, Δm_A and Δm_C
 11 are bounded to be around 0 within a few hundred GeV. Δm_A is constrained to be positive
 12 when $\cos(\beta - \alpha)$ takes a (small) positive value, and negative when $\cos(\beta - \alpha)$ is nega-
 13 tive. The Z -pole precision measurements constrain either $\Delta m_C \sim 0$ or $\Delta m_C \sim \Delta m_A$,
 14 equivalent to $m_{H^\pm} \sim m_{H,A}$. In the small range of $\cos(\beta - \alpha)$ allowed by the current
 15 LHC Higgs precision measurements, the change of the Z -pole constraints due to differ-
 16 ent choices of $\cos(\beta - \alpha)$ is negligible. Combining both the Higgs and Z -pole precisions
 17 (right panel), the allowed $\Delta m_{A,C}$ is further constrained to be in a smaller region. From the
 18 plots, one can see that Z -pole measurements and Higgs measurements are complementary
 19 in constraining the heavy Higgs mass splittings.

2.4 QCD precision measurement

As a fundamental force in nature, the strong force is primarily responsible for the generation of the proton’s mass. The discovery in the 1970’s of Quantum Chromodynamics (QCD) as a correct theory for describing the strong force marks a great achievement in the history of physics. Despite forty years of intense study and much progress, QCD remains the least understood quantum field theory of nature, particularly in its non-perturbative domain. Even at high energy where the strong force becomes weak due to the property of asymptotic freedom, it is still challenging to obtain a quantitative description of QCD phenomena. For example, the “fine structure constant” of QCD, α_s , is eight orders of magnitude less constrained than the fine structure constant of Quantum Electrodynamics (QED). In this respect, QCD is currently the least constrained fundamental force of nature, including gravity. Improving the precision in our understanding of QCD directly impacts our understanding of nature, ranging from the production and decay of the Higgs boson, the partonic structure of proton, and the stability of the Standard Model vacuum.

QCD can be studied at lepton, lepton-hadron, and hadron colliders. Traditionally hadron colliders, such as the Large Hadron Collider (LHC), have been described as QCD machines, because both the initial state and the final state at these colliders are intimately connected to QCD. However, the strongly-interacting nature of the initial state adds additional complications to the description of hard scattering, including the need for the detailed knowledge of Parton Distribution Functions (PDFs), as well as the removal/subtraction of the effects from multiple scattering or underlying events. These complications are absent at a lepton collider, making it an ideal environment for studying QCD at the highest precision. In the past lepton colliders have played an important role in the study of QCD, from the direct observation of gluon jets to the precise extraction of α_s . Compared with LEP, the largest e^+e^- collider ever built, CEPC has substantial improvement in statistics and systematics, therefore allowing QCD to be studied at unprecedented precision. The increase in collision energy will also allow for the exploration of QCD phenomena in territory previously inaccessible at a lepton collider. Besides those well-known problems from the LEP era, many new directions in QCD and jet physics have been opened since the LHC era due increasing attention to the study of jet structure, either as a way to disentangle new physics from QCD backgrounds, or as a probe of QCD dynamics. CEPC will be an ideal machine to address many of these questions at high precision, due to the absence of complications from multiple scattering and underlying events.

Combined with the remarkable progress in QCD theory, ranging from new methods for efficient calculation of cross sections, to the development of effective field theory for collider processes, to new ideas for simulating scattering processes on the lattice, it is expected that CEPC will mark a new chapter in QCD research.

2.4.1 Precision α_s determination

The strong coupling constant α_s is perhaps the most important parameter in QCD. It enters the perturbative predictions of QCD in every observable, in particular cross sections for scattering processes involving hadronic final states at CEPC. A precision determination of α_s at CEPC with unprecedented experimental uncertainties will be an important contribu-

tion to the world's effort to determine α_s . At a lepton collider, α_s can be measured in a number ways. The represented ones include hadronic Z decay, hadronic τ decay, QCD jet rates, and QCD event shape measurements. A summary of α_s determination from these observables using LEP data can be found in Ref. [288].

A distinct feature of CEPC compared with previous lepton colliders is the increase in center-of-mass energy, Q . The measurements which can benefit from increased energy are event shape observables, for which non-perturbative corrections typically scale as $c\Lambda_{\text{QCD}}/Q$, where c is an $O(1)$ parameter that can not be calculated from first principle with our current understanding of QCD. There exist two different approaches in the modeling of non-perturbative hadronization effects for event shapes. One approach is based on corrections for non-perturbative hadronization effects using QCD inspired Monte Carlo tools [381–385], and the other is based on analytic modeling of the non-perturbative shape function [386–390]. Neither of the two treatments can be regarded as fully satisfactory. In the Monte Carlo approach, there is mismatch in the parton level definition of a Monte Carlo simulation and the fixed order calculation. In the analytic power correction approach, the associated systematics have not been fully verified. Therefore, by going to higher center-of-mass energy, the impact of hadronization effects and their associated uncertainties can be reduced.

As an example of α_s determination from event shape observables using analytic power correction, we quote the recent determination based on the C parameter from Ref. [390],

$$\alpha_s(m_Z) = 0.1123 \pm 0.0002_{\text{exp}} \pm 0.0007_{\text{hadr}} \pm 0.0014_{\text{pert}} , \quad (2.28)$$

where hadronization effects and perturbative uncertainties are the main source of uncertainties contributing to α_s determination. While the perturbative uncertainties can be expected to be reduced further in the coming years, given the remarkable progress in the calculation of higher order corrections and in the resummation of large logarithms, the reduction of hadronization uncertainty will likely come from an increase of center-of-mass energy.

Currently, for thrust [387, 391], C parameter [389, 390], and heavy-jet-mass distribution [392], the best theoretical predictions are at the level of $N^3\text{LL}$ resummation matched to NNLO in fixed order perturbation theory. A notable recent development is the calculation of Energy-Energy Correlation (EEC) at NNLO. EEC is an event shape observable which exhibits the so-called rapidity divergence, and leads to additional logarithms to be resummed, compared with thrust and other observables. Very recently, a determination of α_s using NNLL resummation matched to NNLO, and Monte Carlo for the modeling of power corrections, has been done, with the result [393] being

$$\alpha_s(m_Z) = 0.11750 \pm 0.00018_{\text{exp}} \pm 0.00102_{\text{hadr}} \pm 0.00257_{\text{ren}} \pm 0.00078_{\text{res}} , \quad (2.29)$$

where hadronization effects are important source of uncertainties. Since the analysis in Ref. [393] only uses data at or below the Z pole, it is expected that future data from CEPC at 250 GeV can significantly reduce the hadronization uncertainty. Additional scale and resummation uncertainties can also be reduced in the future by incorporating $N^3\text{LL}$ resummation [394].

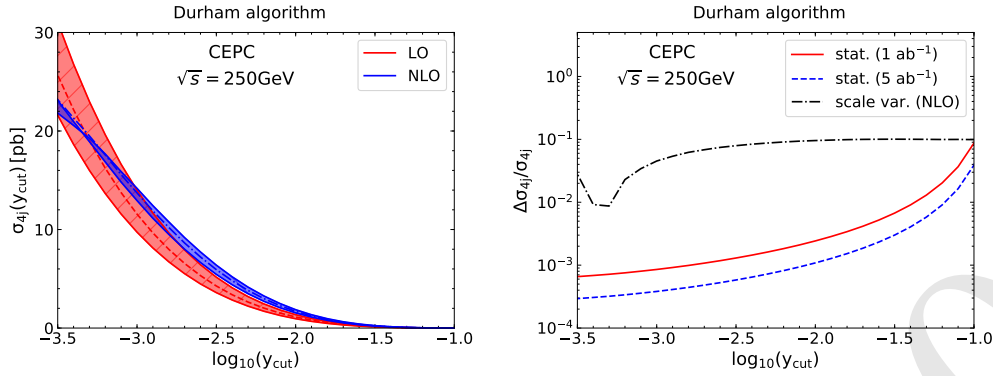

Figure 2.38: **Left:** The four-jet production cross section at CEPC ($\sqrt{s} = 250$ GeV) with the Durham jet algorithm as a function of the resolution parameter y_{cut} . **Right:** The scale variation and expected statistical uncertainties for the same cross sections normalized to their central values.

2.4.2 Jet rates at CEPC

Another distinct feature of CEPC compared with LEP is its unprecedented luminosity, in particular above the Z pole. The higher luminosity opens the door for the precision study of multi-jet production at an e^+e^- collider.

As an example, we show in Figure 2.38 the four-jet production cross sections at CEPC ($\sqrt{s} = 250$ GeV) with the Durham jet algorithm as a function of the resolution parameter y_{cut} , calculated using NLOjet++ [395]. The cross sections are at the level of a few pb to tens of pb for the range of y_{cut} considered. The colored bands represent the scale variations calculated by varying the renormalization scale from $\sqrt{s}/2$ to $2\sqrt{s}$. The NLO predictions show a smaller scale variation as compared to the LO ones. The cross sections diverge for small resolution parameter where further QCD resummations are needed to stabilize the theoretical predictions. The right panel shows the projected statistical uncertainties assuming an integrated luminosity of 1 and 5 ab^{-1} . The statistical uncertainties are at the level of one per mille or better for y_{cut} below 10^{-2} due to the large luminosity. The scale uncertainties of the NLO predictions are large in comparison and about 10%, which can be reduced with QCD resummation [395]. The n -jet rate has been employed to measure the strong coupling constant α_s at LEP [396]. The four-jet cross sections are proportional to α_s^2 at leading order, thus the statistical uncertainties in the measurement of α_s are estimated to be well below one per mille. On the other hand, the theoretical uncertainties will play a dominant role and need further investigation. Currently, NNLO predictions for e^+e^- to three jets are available [397–401]. Along this line there has been remarkable progress in the calculation of two-loop amplitudes with five external particles [402, 403] and its associated integrals [404, 405]. Although there is still substantial work to be done, an NNLO calculation for four jet production can be expected in the future. There has also been progress in resumming the large logarithms in jet rates. A Monte Carlo approach for resummation has been proposed and used to resum the large logarithms in two-jet rates in Ref. [406], which can achieve resummation at NNLL level. Ideally this approach can be extended to three and four jet rates.

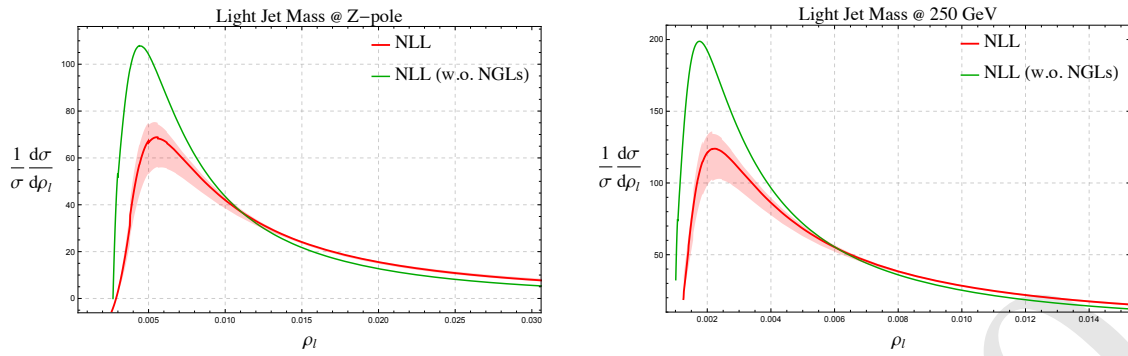

Figure 2.39: The normalized light-jet-mass distribution both at Z -pole (left) and at 250 GeV (right). Green curves are NLL results without NGLs, and red bands are full NLL results with scale uncertainties.

2.4.3 Non-global logarithms

Besides the precision extraction of α_s from jetty final states, there has also been significant interest in understanding some novel aspects of QCD dynamics from jet processes at a lepton collider. An important example is the study of non-global logarithms (NGL) [407, 408].

Non-global logarithms are significant obstacles in the study of soft physics at high energy colliders (jet physics, energy flow measurements, hadronization, and so on). Therefore it is important to develop a theoretical framework to understand their structure. NGLs were first pointed out by Dasgupta and Salam in Ref. [407], where they developed a Monte-Carlo algorithm to resum leading-logarithmic(LL) NGLs in the large N_c limit. After that work, based on the strong energy ordering limit, Banfi, Marchesini and Smye derived an integral-differential evolution equation that can also resum LL NGLs [408]. Since then, there has been a great effort to improve the theoretical predictions [409–414], including the sub-leading N_c effects [415–417] and some fixed-order calculations [418, 419].

Recently, there have been several developments in this field [420–428]. One example is the effective field theory developed in Ref. [422]; this reference was the first to write down the factorization formula for non-global observables and to give an any-order renormalization group evolution equation for NGLs.

As an electron-positron collider, CEPC will provide new opportunities, which can precisely measure NGLs in many observables. Figure 2.39 shows the normalized light-jet-mass distribution both at Z -pole (left) and at 250 GeV (right). Green curves are NLL results without NGLs, and red bands are full NLL results with scale uncertainties. Obviously, after including NGLs theoretical predictions are reduced significantly, and this reduction is especially magnificent at 250 GeV. Therefore CEPC will give us the first opportunity to measure NGLs.

2.4.4 QCD event shapes and light quark Yukawa coupling

The SM Higgs boson decays dominantly to various hadronic final states with a total branching fraction of more than 80%. These hadronic decays provide a new source for QCD studies at CEPC (in its Higgs factory mode). In particular, Higgs decays produce a unique color-neutral digluon state. Table 2.3 summarizes the estimated number of events

$Z(l^+l^-)H(X)$	gg	$b\bar{b}$	$c\bar{c}$	$WW^*(4h)$	$ZZ^*(4h)$	$q\bar{q}$
BR [%]	8.6	57.7	2.9	9.5	1.3	~ 0.02
N_{event}	6140	41170	2070	6780	930	14

Table 2.3: This table shows branching ratios (BR) for decays of the SM Higgs boson in different hadronic channels [430] and the number of expected events (N_{event}) for ZH production at CEPC ($\sqrt{s} = 250$ GeV and $\mathcal{L} = 5$ ab $^{-1}$) with the corresponding hadronic Higgs decay. In this table, H represents the Higgs boson, h represents any of the quarks except the top quark, and q are light quarks.

1 for different hadronic decay modes of the Higgs boson, assuming that the tagged Z boson
2 decays into electrons or muons.

3 At CEPC the traditional hadronic event shapes, e.g., thrust distribution, can be well
4 measured due to the high statistics. At a lepton collider one can reconstruct the kine-
5 matics fully and then boost all final states back to the rest frame of the decaying Higgs
6 boson. On the theory side those distributions can be calculated with high precision by
7 QCD resummation matched with fixed-order results. There exist uncertainties from non-
8 perturbative QCD effects, e.g. hadronization modeling, which are usually estimated by
9 Monte Carlo event generators. The left panel of Figure 2.40 shows the normalized dis-
10 tribution of the variable thrust for several different hadronic decay channels of the Higgs
11 boson, including gg , $q\bar{q}$, $b\bar{b}$, and $W(q\bar{q})W^*(q\bar{q})$ [429]. The distribution peaks at $\tau \sim 0.02$
12 for the light-quark decay channel. The peak shifts to $\tau \sim 0.05$ for the gluon channel, cor-
13 responding to a scaling of roughly C_A/C_F . The distribution is much broader for the gluon
14 case due to the stronger QCD radiation. The distribution for the $b\bar{b}$ channel is very close
15 to the $q\bar{q}$ case, except at very small τ , where the mass and hadronization effects become
16 important. For the WW^* channel there already exist four quarks at leading order and the
17 distribution is concentrated in the large- τ region.

18 Different shapes of the thrust distribution from diquark and digluon final states mo-
19 tivates the idea of using global event shapes to probe the Yukawa couplings of light
20 quarks [429], namely strange, up and down quarks. The provided discrimination can
21 largely reduce background due to Higgs boson decays into two gluons while backgrounds
22 from Higgs boson decays into heavy quarks can be suppressed with the usual heavy-flavor
23 tagging algorithms. It is a great challenge to probe the light-quark Yukawa couplings since
24 they are very small and the expected number of events with CEPC's full luminosity is
25 only 14, as shown in Table 2.3. The expected exclusion limits on decay branching ratios
26 of Higgs boson to light quarks are shown in the right plot of Figure 2.40, indicated by
27 intersections with the vertical line and normalized to the branching ratio to digluon. The
28 results can be translated into an upper limit of 0.48% on the decay branching ratios or 5
29 times of the Standard Model value for the Yukawa coupling of strange quark.

30 2.5 Flavor Physics with the Z factory of CEPC

31 A high luminosity Z factory that produces 10^{12} Z bosons provides unique opportunities
32 for various flavor measurements. In particular, the decay of 10^{12} Z bosons will result
33 in approximately 10^{11} b hadrons, which is almost two orders of magnitude larger than
34 the number of B mesons produced at the B factories BaBar and Belle and comparable
35 to the number of B mesons expected at Belle II. As the B factories are running mainly

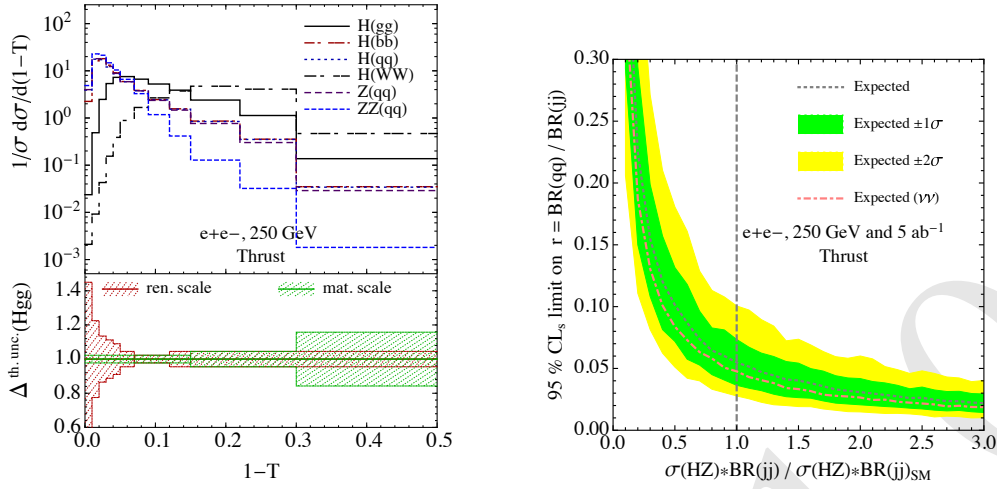

Figure 2.40: Left: The normalized distributions of thrust in hadronic Higgs decay, in $e^+e^- \rightarrow q\bar{q}$ with $\sqrt{s} = 125$ GeV and in $e^+e^- \rightarrow Zq\bar{q}$ with $\sqrt{s} = 250$ GeV. **Right:** CEPC's capacity to probe the Higgs boson's decay into light quarks. The green and yellow bands show the expected 95% C.L. exclusion limit on $r = BR(qq)/BR(jj)$ as a function of the total cross section of the Higgs boson decay to jj normalized to the SM value.

1 on the $\Upsilon(4S)$ resonance, they mostly produce B^0 and B^\pm mesons; they also produce B_s
 2 mesons but in much smaller numbers from shorter runs on $\Upsilon(5S)$. A machine running
 3 on the Z -pole on the other hand will not only produce a large number of B_s mesons,
 4 but also a large sample of b baryons. In Table 2.4 we compare the expected numbers of
 5 produced b -hadrons corresponding to 10^{12} Z -boson decays to those produced with the
 6 $50 ab^{-1}$ run on $\Upsilon(4S)$ and the $5 ab^{-1}$ run on $\Upsilon(5S)$ of Belle II. For the tera- Z we also
 7 list number of produced charmed hadrons and tau leptons (we use the known Z branching
 8 fractions $BR(Z \rightarrow b\bar{b}) = (15.12 \pm 0.05)\%$, $BR(Z \rightarrow c\bar{c}) = (12.03 \pm 0.21)\%$, and
 9 $BR(Z \rightarrow \tau^+\tau^-) = (3.3696 \pm 0.0083)\%$ [288] and the b and c hadronization fractions at
 10 the Z pole from Refs. [431–433]). Using the large sample of produced b/c hadrons and
 11 taus, the tera- Z factory of CEPC will be able to access many rare decays of these particles,
 12 many with a precision beyond any of the ongoing or planned experiments. In addition,
 13 the 10^{12} Z bosons would also allow measurements of flavor violating Z decays with an
 14 unprecedented precision.

15 A future circular electron–positron collider does not only benefit from its large statist-
 16 tics. Compared to LHCb, an electron–positron collider offers a much cleaner environment
 17 and, therefore, generally smaller background levels. Compared to the Belle II flavor fac-
 18 tory, running at the Z -pole leads to a much larger boost of the b hadrons and their decay
 19 products, which is in particularly useful in constraining decays with missing energy, e.g.,
 20 decays with neutrinos in the final state.

21 In section 2.5.1 we discuss the prospects of measuring a number of rare b -hadron decays
 22 at the tera- Z factory of CEPC: we cover leptonic decays, semi-leptonic decays, and decays
 23 with missing energy. Particular emphasis is laid on rare decays to final states with tau
 24 leptons, in which the sensitivity of the tera- Z program of CEPC will be unparalleled. We
 25 also comment on possible implications of the current hints for lepton-flavor-universality
 26 violation in rare B decays, that have been observed by LHCb. A discussion of tau decays
 27 follows in Section 2.5.2, where we discuss the prospects of CEPC to significantly
 28 improve lepton universality tests in leptonic tau decays as well as its prospects for mea-

Particle	@ Tera- Z	@ Belle II	
b hadrons			
B^+	6×10^{10}	3×10^{10}	(50 ab^{-1} on $\Upsilon(4S)$)
B^0	6×10^{10}	3×10^{10}	(50 ab^{-1} on $\Upsilon(4S)$)
B_s	2×10^{10}	3×10^8	(5 ab^{-1} on $\Upsilon(5S)$)
b baryons			
Λ_b	1×10^{10}		
c hadrons			
D^0	2×10^{11}		
D^+	6×10^{10}		
D_s^+	3×10^{10}		
Λ_c^+	2×10^{10}		
τ^+	3×10^{10}	5×10^{10}	(50 ab^{-1} on $\Upsilon(4S)$)

Table 2.4: Collection of expected number of particles produced at a tera- Z factory from 10^{12} Z -boson decays. We have used the hadronization fractions (neglecting p_T dependences) from Refs. [431, 432] (see also Ref. [433]). For the decays relevant to this study we also show the corresponding number of particles produced by the full 50 ab^{-1} on $\Upsilon(4S)$ and 5 ab^{-1} on $\Upsilon(5S)$ runs at Belle II.

- 1 suring rare, lepton-flavor violating tau decays. Flavor violating Z decays are discussed in
2 section 2.5.3.

3 2.5.1 Rare B decays

4 2.5.1.1 Leptonic decays $B^0 \rightarrow \ell^+\ell^-$ and $B_s \rightarrow \ell^+\ell^-$

The purely leptonic $B_s \rightarrow \ell^+\ell^-$ and $B^0 \rightarrow \ell^+\ell^-$ decays are strongly suppressed in the Standard Model and therefore highly sensitive to new-physics contributions. Their branching ratios are known with high precision in the Standard Model [434]

$$\text{BR}(B_s \rightarrow e^+e^-)_{\text{SM}} = (8.54 \pm 0.55) \times 10^{-14}, \quad (2.30)$$

$$\text{BR}(B^0 \rightarrow e^+e^-)_{\text{SM}} = (2.48 \pm 0.21) \times 10^{-15}, \quad (2.31)$$

$$\text{BR}(B_s \rightarrow \mu^+\mu^-)_{\text{SM}} = (3.65 \pm 0.23) \times 10^{-9}, \quad (2.32)$$

$$\text{BR}(B^0 \rightarrow \mu^+\mu^-)_{\text{SM}} = (1.06 \pm 0.09) \times 10^{-10}, \quad (2.33)$$

$$\text{BR}(B_s \rightarrow \tau^+\tau^-)_{\text{SM}} = (7.73 \pm 0.49) \times 10^{-7}, \quad (2.34)$$

$$\text{BR}(B^0 \rightarrow \tau^+\tau^-)_{\text{SM}} = (2.22 \pm 0.19) \times 10^{-8}. \quad (2.35)$$

- 5 Presently, LHCb has provided the most sensitive measurement of the $\mu^+\mu^-$ decays with
6 a precision at the level of 10^{-9} [435]. The current most stringent bound on the e^+e^-
7 modes is still coming from CDF [436]. With 50 fb^{-1} of data, LHCb is expected to reach
8 sensitivities of approximately 10^{-10} in the muonic modes and $\text{few} \times 10^{-10}$ in the electronic
9 modes [437].

To estimate the sensitivity of a tera- Z factory for the decays to electrons and muons we rescale the existing bound from the L3 collaboration [438] from the full LEP-I data sam-

ple, which corresponds to approximately 3×10^5 , and 9×10^4 B^0 's, and B_s 's, respectively. A naive rescaling of these bounds accounting for the number of B^0 's and B_s 's produced at a tera- Z factory gives:

$$\text{BR}(B_s \rightarrow e^+e^-)_{\text{tera-Z}} \lesssim 4 \times 10^{-10}, \quad (2.36)$$

$$\text{BR}(B^0 \rightarrow e^+e^-)_{\text{tera-Z}} \lesssim 8 \times 10^{-11}, \quad (2.37)$$

$$\text{BR}(B_s \rightarrow \mu^+\mu^-)_{\text{tera-Z}} \lesssim 3 \times 10^{-10}, \quad (2.38)$$

$$\text{BR}(B^0 \rightarrow \mu^+\mu^-)_{\text{tera-Z}} \lesssim 7 \times 10^{-11}. \quad (2.39)$$

1 Note, that this linear scaling with the number of B mesons assumes that backgrounds
 2 can be kept under control also at the CEPC. The comparison with the projections from
 3 LHCb [437] shows that LHCb with 50 fb^{-1} will likely outperform the tera- Z factory by a
 4 factor of few for the muonic modes. For the electronic modes the tera- Z factory may be
 5 able to compete with LHCb.

The rare B decays to the $\tau^+\tau^-$ final state are experimentally still a largely uncharted territory. The existing bound from BaBar [439], $\text{BR}(B^0 \rightarrow \tau^+\tau^-) < 4.1 \times 10^{-3}$, is orders of magnitude away from the corresponding SM prediction. Measurements of the $\tau^+\tau^-$ final states are highly challenging at LHCb. The current sensitivities are at the level of $\text{few} \times 10^{-3}$ [440] and could improve down to $\text{few} \times 10^{-4}$ [437]. Also Belle II will likely only reach sensitivities at the level of 10^{-4} for $B^0 \rightarrow \tau^+\tau^-$ [441]. The decays $B^0 \rightarrow \tau^+\tau^-$ and $B_s \rightarrow \tau^+\tau^-$ are thus prime examples of processes to which a circular electron-positron collider running at the Z pole is uniquely sensitive. As no dedicated study exists at them moment for the sensitivity of tera- Z factory to these decays, we estimate it by comparing Belle II's relative sensitivity between the $B^0 \rightarrow \mu^+\mu^-$ and the $B^0 \rightarrow \tau^+\tau^-$ modes. The corresponding rough estimates read

$$\text{BR}(B^0 \rightarrow \tau^+\tau^-)_{\text{tera-Z}} < 4 \times 10^{-6}, \quad (2.40)$$

$$\text{BR}(B_s \rightarrow \tau^+\tau^-)_{\text{tera-Z}} < 2 \times 10^{-5}. \quad (2.41)$$

6 These estimates do not account for the higher boost of the decay products in a Z factory.
 7 We thus expected them to be conservative, i.e., CEPC's sensitivity may be even higher. We
 8 thus find that CEPC's tera- Z factory will provide the by far most stringent measurements
 9 of the $B_s \rightarrow \tau^+\tau^-$ and $B^0 \rightarrow \tau^+\tau^-$ decays, improving the expected sensitivities at LHCb
 10 and Belle II by more than an order of magnitude.

11 2.5.1.2 Semileptonic decays $b \rightarrow s(d)\ell^+\ell^-$

12 Semileptonic FCNC decays of b -mesons are not as theoretically clean as the $B_{s,d} \rightarrow \ell^+\ell^-$
 13 decays. They are, however, *i)* less rare within the SM, which makes them experimentally
 14 more accessible, and *ii)* three-body or four-body decays resulting in multiple observables
 15 for a given mode, e.g., invariant-mass and angular distribution observables, CP asymme-
 16 tries, etc.

17 In recent years, the exclusive decays $B \rightarrow K^{(*)}e^+e^-$ and $B \rightarrow K^{(*)}\mu^+\mu^-$ have at-
 18 tracted a lot of attention due to the large number of LHCb measurements and in particular
 19 due to some persistent $\approx 2 - 3\sigma$ tensions between data and SM expectations in related ob-
 20 servables, i.e., $R_{K^{(*)}}$ [442, 443] theoretically clean observables that tests for lepton-flavor-
 21 universality violation, and the angular observable P_5' [444]. The tensions are present in
 22 LHCb's Run-1 data set of 3 fb^{-1} , with Run-2 results yet to be announced. We expect

significant progress as LHCb collects a data set of 50 fb^{-1} . Belle II will also probe these exclusive modes. Its 50 ab^{-1} run on $\Upsilon(4S)$ will provide measurements of these modes with a precision not much lower than LHCb with its full data set [441]. As the number of B^0 and B^+ mesons produced at the tera- Z factory and at Belle II are approximately the same, we ultimately expect a similar precision at the two machines. In this respect, the CEPC's measurements of these modes will be invaluable, especially if the tensions in the exclusive $B \rightarrow K^{(*)}e^+e^-$ and $B \rightarrow K^{(*)}\mu^-\mu^+$ persist in the full data set of LHCb. In such a case, the CEPC's program will provide a new data set and will be able to independently confirm the existence of new-physics effects in the electronic and muonic decays.

Both Belle II and CEPC will also be able to access the inclusive decays $B \rightarrow X_s e^+e^-$ and $B \rightarrow X_s \mu^+\mu^-$ with comparable precision. Hadronic uncertainties are under better control in the inclusive modes and their measurements will complement the studies of the exclusive decays mentioned above.

Contrary to the ee and $\mu\mu$ modes, little experimental information exists on the semi-tauonic modes $b \rightarrow s(d)\tau^+\tau^-$ so far. The only existing bound from BaBar [445], $\text{BR}(B \rightarrow K\tau^+\tau^-) < 3.3 \times 10^{-3}$, is approximately four orders of magnitude above the SM prediction and it is not clear whether LHCb will be able to improve the sensitivity substantially. The first major improvements are thus expected at Belle II. For instance, its 50 ab^{-1} run will probe the branching ratio of $B^+ \rightarrow K^+\tau^+\tau^-$ at the level of 2×10^{-5} [441]. A dedicated study is required to quantitatively assess the full potential of the tera- Z factory, which is expected to outperform Belle II in modes as the ones in question, in which missing energy from the tau decays is present in the event. A study for the FCC- ee program that investigates the $B^0 \rightarrow K^*\tau^+\tau^-$ decay [446], finds that approximately a thousand cleanly reconstructed events are expected from 10^{13} Z 's. We thus expect approximately hundred events at the tera- Z factory probing the SM branching ratio of $\sim 10^{-7}$ with a statistical uncertainty of 10%. We see that, similarly to the $B_q \rightarrow \tau^-\tau^+$ mode, also here the tera- Z factory will provide the by far most accurate measurements. With hundred events even a partial angular analysis might be possible. Additionally, the large number of B_s mesons and Λ_b baryons produced at the tera- Z factory will facilitate the first measurements of the corresponding decays, $B_s \rightarrow \phi\tau^+\tau^-$, and $\Lambda_b \rightarrow \Lambda\tau^+\tau^-$ at a similar level of precision. The measurements of the semi-tauonic decay will also open the path towards measurements of lepton-flavor-universality violation involving not only electrons and muons, but also taus, which will be of particular interest if the present tensions in the muon–electron data persist.

2.5.1.3 Decays with missing energy $b \rightarrow s(d)\nu\bar{\nu}$

The rare FCNC decays $B \rightarrow K^{(*)}\nu\bar{\nu}$ are widely recognized as important flavor probes, as they are not affected by non-factorizable corrections and thus theoretically cleaner compared to $b \rightarrow s\ell\ell$ transitions. The SM predictions for the branching ratios of these decays read [447]

$$\text{BR}(B^+ \rightarrow K^+\nu\bar{\nu})_{\text{SM}} = (4.68 \pm 0.64) \times 10^{-6}, \quad (2.42)$$

$$\text{BR}(B^0 \rightarrow K^0\nu\bar{\nu})_{\text{SM}} = (2.17 \pm 0.30) \times 10^{-6}, \quad (2.43)$$

$$\text{BR}(B^+ \rightarrow K^{*+}\nu\bar{\nu})_{\text{SM}} = (10.22 \pm 1.19) \times 10^{-6}, \quad (2.44)$$

$$\text{BR}(B^0 \rightarrow K^{*0}\nu\bar{\nu})_{\text{SM}} = (9.48 \pm 1.10) \times 10^{-6}, \quad (2.45)$$

1 with uncertainties in the theoretical predictions of roughly 10%, dominated by parametric
 2 and form-factor uncertainties. The accuracy of these predictions in combination with the
 3 fact that these modes have not yet been observed (current bounds are typically an order
 4 magnitude away from the SM predictions, e.g., see Ref. [448]), is the reason why these
 5 modes are prime candidates for disentangling small new-physics contributions. Since
 6 the neutrinos are never tagged in the experiments, such modes are not only relevant for
 7 searches for heavy new physics, but can also provide the leading constraints in mod-
 8 els with light, long-lived particles with small flavor-violating couplings, e.g., the “axi-
 9 flavon” [449].

10 With its full, 50 ab^{-1} dataset run on $\Upsilon(4S)$, Belle II is expected to probe for the first time
 11 deviations from the SM predictions at a level of approximately 17% [450]. The dominant
 12 uncertainties in such measurements are expected to be due to statistics. The related decays
 13 based on the $b \rightarrow d\nu\bar{\nu}$ transition, i.e., $B \rightarrow \pi\nu\bar{\nu}$ and $B \rightarrow \rho\nu\bar{\nu}$, are further suppressed in
 14 the SM by a factor of approximately 30. Limits at a level of 10^{-6} are expected at Belle II.

15 Given that the number of B^0 and B^+ particles produced with 50 ab^{-1} at Belle II are
 16 roughly the same at a tera- Z factory, we expect similar statistical uncertainties there.
 17 Therefore, at the very least, the tera- Z factory will probe the SM predictions of $B \rightarrow$
 18 $K^{(*)}\nu\bar{\nu}$, $B \rightarrow \pi\nu\bar{\nu}$, and $B \rightarrow \rho\nu\bar{\nu}$ at the same level as Belle II. However, this estimate
 19 does not take into account the favourable kinematic environment of a tera- Z factory. The
 20 larger, with respect to Belle II, boost of the B mesons in a collider running on the Z pole
 21 persists on the neutrino system. This leads to a robust measurement of missing energy,
 22 which is instrumental for the searches of these decays. While a dedicated study would
 23 be needed to quantitatively assess this advantage, it may well be the case that this will be
 24 enough to tilt the balance in favour of the tera- Z factory.

25 As illustrated in Table 2.4 the tera- Z factory will produce two orders of magnitude more
 26 $B_s^{(*)}$ mesons than a $5, \text{ ab}^{-1}$ run of Belle II on $\Upsilon(5S)$. Also, approximately 10^{10} b baryons
 27 will be produced at the tera- Z factory, whereas none can be produced at Belle II without
 28 (not planned) dedicated runs. The tera- Z factory will thus for the first time have access to
 29 decay modes of B_s mesons and Λ_b baryons, like $B_s \rightarrow \phi\nu\bar{\nu}$ and $\Lambda_b \rightarrow \Lambda\nu\bar{\nu}$. Given the
 30 large statistical sample, we expect the tera- Z factory to probe these branchings fractions at
 31 a level similar to the related B_0 and B^+ modes, i.e., branching fractions of approximately
 32 10^{-6} .

33 More than one higher-dimensional operator of the five-flavor effective theory can in-
 34 duce these decays. By probing multiple members of this whole family of decays, the
 35 measurements of the tera- Z -factory will probe more than a single linear combination of
 36 operators. For instance, the combination of the information from the pseudoscalar to pseu-
 37 doscalar transitions ($B \rightarrow K\nu\bar{\nu}$), the pseudoscalar to vector transitions ($B \rightarrow K^*\nu\bar{\nu}$ and
 38 $B_s \rightarrow \phi\nu\bar{\nu}$), as well as the fermion to fermion transition ($\Lambda_b \rightarrow \Lambda\nu\bar{\nu}$) could be a way to
 39 disentangle possible new-physics contributions from right-handed currents.

40 2.5.1.4 Probing new physics with $b \rightarrow s(d)\tau^+\tau^-$ decays

41 There are many new-physics scenarios, e.g., models with extended Higgs sectors, or ex-
 42 tended gauge sectors, or scenarios with leptoquarks, that could give rise to sizable effects
 43 in leptonic or semi-leptonic $\tau^+\tau^-$ modes, without violating constraints from the e^+e^-
 44 and/or $\mu^+\mu^-$ channels. Model independently, tau specific new physics in rare B decays

1 can be encoded in an effective Lagrangian

$$\mathcal{L}_{\text{NP}} = -\frac{G_F}{\sqrt{2}} V_{tb} V_{tq}^* \frac{e^2}{16\pi^2} \sum_i \left(C_i O_i + C'_i O'_i \right), \quad q = s, d, \quad (2.46)$$

with the operators

$$\begin{aligned} O_7 &= (\bar{q} \sigma_{\mu\nu} P_R b) F^{\mu\nu}, & O'_7 &= (\bar{q} \sigma_{\mu\nu} P_L b) F^{\mu\nu}, \\ O_9 &= (\bar{q} \gamma_\mu P_L b) (\bar{\tau} \gamma^\mu \tau), & O'_9 &= (\bar{q} \gamma_\mu P_R b) (\bar{\tau} \gamma^\mu \tau), \\ O_{10} &= (\bar{q} \gamma_\mu P_L b) (\bar{\tau} \gamma^\mu \gamma_5 \tau), & O'_{10} &= (\bar{q} \gamma_\mu P_R b) (\bar{\tau} \gamma^\mu \gamma_5 \tau), \\ O_S &= (\bar{q} P_R b) (\bar{\tau} P_L \tau), & O'_S &= (\bar{q} P_L b) (\bar{\tau} P_R \tau). \end{aligned}$$

2 Constraining all possible $\tau^+ \tau^-$ operators requires measurements of both the leptonic and
3 semi-leptonic modes, as they have different blind directions in the parameter space of
4 Wilson coefficients [451, 452]. Note, that also the decays with neutrinos, $b \rightarrow q \nu \bar{\nu}$, can
5 constrain the operator-combinations that contain a left-handed tau current $O_9 - O_{10}$ and
6 $O'_9 - O'_{10}$, due to $\text{SU}(2)_L$ invariance. On the other hand, the neutrino modes are blind to
7 the orthogonal directions $O_9 + O_{10}$ and $O'_9 + O'_{10}$, which contain right-handed tau currents.

8 There are various new-physics models that can lead to non-standard effects in $b \rightarrow$
9 $(d, s) \tau^+ \tau^-$ decays. Interestingly, several models that address the LHCb anomalies in the
10 $B \rightarrow K^* \mu^+ \mu^-$ angular distribution or the hints for lepton-flavor-universality violation in
11 $R_{K^{(*)}}$ [442, 443] or $R_{D^{(*)}}$ [453] predict characteristic non-standard effects in $b \rightarrow s \tau^+ \tau^-$
12 transitions.

13 The model proposed in Ref. [454] is based on gauging the difference of muon- and
14 tau-number, $L_\mu - L_\tau$. Given the current anomalies in $b \rightarrow s \mu^+ \mu^-$, the model predicts that
15 all semi-leptonic $b \rightarrow s \mu^+ \mu^-$ decays are suppressed by approximately 25% [455]. The
16 $L_\mu - L_\tau$ symmetry implies that all semi-leptonic $b \rightarrow s \tau^+ \tau^-$ decays are instead enhanced
17 by a similar amount. However, the $B_s \rightarrow \tau^+ \tau^-$ decay remains SM-like in the $L_\mu - L_\tau$
18 framework.

19 In the new-physics scenarios originally introduced in Refs. [456–458], the current B -
20 physics anomalies are addressed by non-standard left-handed currents involving mainly
21 the 3rd generation of quarks and leptons. In such scenarios, enhancements of $B_s \rightarrow \tau^+ \tau^-$
22 and $b \rightarrow s \tau^+ \tau^-$ rates by an order of magnitude compared to the SM predictions are
23 possible. Left-handed currents also imply a strong correlation between $b \rightarrow s \tau^+ \tau^-$ and
24 $b \rightarrow s \nu \bar{\nu}$ decays, as well as enhanced $b \rightarrow s \nu \bar{\nu}$ rates. On the other hand, enhancements
25 of $b \rightarrow s \tau^+ \tau^-$ rates that are independent of $b \rightarrow s \nu \bar{\nu}$ are possible in models with right-
26 handed lepton currents. In such scenarios the current experimental bounds can in principle
27 be saturated.

28 2.5.2 Tau decays

29 From Table 2.4 we see that at the tera- Z factory of CEPC we can expect approximately
30 3×10^{10} $\tau^+ \tau^-$ pairs produced from Z decays. This is comparable to the expected number
31 of taus produced at Belle II, i.e., roughly 5×10^{10} . This suggests that the sensitivities to
32 lepton-flavor violating decays of taus at CEPC can be similar to the sensitivities expected
33 at Belle II. The large boost of taus from the Z decays is expected to allow CEPC to
34 measure the standard leptonic branching ratios of the tau and to test lepton universality in
35 $\tau \rightarrow \ell \nu \bar{\nu}$ with unprecedented precision.

2.5.2.1 Lepton universality in $\tau \rightarrow \ell\nu\bar{\nu}$

The best measurements of the leptonic branching ratios of the tau, $\text{BR}(\tau \rightarrow \mu\nu_\tau\bar{\nu}_\mu)$ and $\text{BR}(\tau \rightarrow e\nu_\tau\bar{\nu}_e)$, still come from LEP [288]. The most precise individual results are from Aleph [459] and read $\text{BR}(\tau \rightarrow \mu\nu_\tau\bar{\nu}_\mu) = (17.319 \pm 0.070 \pm 0.032)\%$ and $\text{BR}(\tau \rightarrow e\nu_\tau\bar{\nu}_e) = (17.837 \pm 0.072 \pm 0.036)\%$, where the first uncertainty is due to statistics and the second due to systematics. One can see that the measurements were statistics limited with systematic uncertainties at the level of approximately 2 permille. This implies that the larger statistics of a tera- Z program at the CEPC will result in the world best measurement of these branching ratios with uncertainties at the permille level or even much better. Indeed, it is very likely that the much larger number of τ pairs will also allow the experiments to gain a much better control of systematic uncertainties. Assuming that systematics can be reduced by an order of magnitude (which requires exquisite control of the electron and muon efficiencies), the leptonic tau branching ratios could be measured at CEPC with a relative uncertainty of 10^{-4} . Dedicated studies are required to establish the precise sensitivity of CEPC.

The leptonic branching ratios of the tau can in principle be predicted with very high precision in the SM [460]. The SM precision is limited by the uncertainty in the measured tau lifetime, τ_τ . The most precise tau lifetime determination comes currently from Belle [461] and has an uncertainty of approximately 2 permille. Given the much higher statistics expected at Belle II, future measurements may be able to improve the precision of τ_τ by up to an order of magnitude. We expect that CEPC could reach a precision for τ_τ similar to Belle II. The precise relation between the τ lifetime and the leptonic branching ratios in the SM, combined with future precise determinations of $\text{BR}(\tau \rightarrow \mu\nu_\tau\bar{\nu}_\mu)$ and $\text{BR}(\tau \rightarrow e\nu_\tau\bar{\nu}_e)$ at CEPC would allow to scrutinize the weak interactions in tau decays with an unprecedented precision.

Additional information can be extracted from measurements of kinematic distributions in tau decays and the determination of the tau decay parameters (also known as Michel parameters) [288], which are highly sensitive to the structure (spin and chirality) of the current that mediates tau decays. CEPC can be expected to substantially improve the existing (LEP) and expected (Belle II) measurements of tau decay parameters.

In addition to measurements of the absolute leptonic branching ratios and their kinematic distributions, it is of particular interest to look at the lepton-flavor universality ratio

$$R_\tau = \frac{\text{BR}(\tau \rightarrow \mu\nu_\tau\bar{\nu}_\mu)}{\text{BR}(\tau \rightarrow e\nu_\tau\bar{\nu}_e)}. \quad (2.47)$$

This ratio is independent of the tau lifetime and can be predicted with extremely high precision in the SM, $R_\tau^{\text{SM}} = 0.972559 \pm 0.000005$ [460]. The currently most precise direct measurement of this ratio comes from BaBar and has an uncertainty of approximately 4 permille, $R_\tau^{\text{BaBar}} = 0.9796 \pm 0.0016 \pm 0.0036$ [462]. A measurement of R_τ with an uncertainty of 10^{-4} may be possible at CEPC (cf. discussion above about the expected precision in the absolute branching ratios).

Most new-physics models that explain the current hints for lepton-flavor universality violation in B decays, $R_{K^{(*)}}$ [442, 443] and $R_{D^{(*)}}$ [453] also lead to lepton-flavor universality violation in $\tau \rightarrow \mu\nu_\tau\bar{\nu}_\mu$ vs. $\tau \rightarrow e\nu_\tau\bar{\nu}_e$ [463, 464]. Typical new-physics effects are at the level of a few permille and should be well within the reach of CEPC. Therefore,

1 more accurate measurements of R_τ would be invaluable to scrutinize many motivated
2 new-physics scenarios.

3 2.5.2.2 Lepton-flavor violating τ decays

4 In the SM without neutrino masses, lepton flavor is conserved and lepton-flavor violating
5 tau decays are completely absent. While non-zero neutrino masses in principle lead to
6 lepton-flavor violating tau decays, branching ratios like $\tau \rightarrow \mu\gamma$ are predicted at the level
7 of 10^{-45} . However, in models of new physics such branching ratios could be enhanced by
8 many orders of magnitude and could be in reach of experimental searches. In this sense,
9 any observation of lepton-flavor violating tau decays would be an unambiguous sign of
10 physics beyond the SM.

11 Lepton-flavor violating tau decays have been searched for in a multitude of channels
12 at the B factories BaBar and Belle. Among them are the radiative modes $\tau \rightarrow \mu\gamma$ and
13 $\tau \rightarrow e\gamma$, purely leptonic modes like $\tau \rightarrow 3\mu$, $\tau \rightarrow 3e$, $\tau \rightarrow \mu ee$, etc., as well as many
14 hadronic modes like $\tau \rightarrow \mu\pi^0$, $\tau \rightarrow e\pi^0$, $\tau \rightarrow \mu K$, etc. Most of these decays have
15 been constrained at the level of 10^{-8} [431]. Thanks to its increase in statistics, Belle II is
16 expected to improve the sensitivities to the lepton-flavor violating tau decays by at least
17 one order of magnitude or even more in very clean modes like $\tau \rightarrow 3\mu$.

18 The clean signature of three muons allows LHCb to search for the decay $\tau \rightarrow 3\mu$ with
19 high sensitivity. The current limit, which has been obtained with 3 fb^{-1} of the combined
20 7 TeV and 8 TeV data, reads $\text{BR}(\tau \rightarrow 3\mu)_{\text{LHCb}} < 4.6 \times 10^{-8}$ [465] and is competitive with
21 the existing bounds from BaBar and Belle. In the high-luminosity phase of LHC, LHCb
22 will likely improve this bound by one order of magnitude down to few times 10^{-9} .

23 Given the comparable numbers of taus that will be produced at Belle II and that could be
24 expected from the tera- Z factory at CEPC, we expect similar sensitivities to these decays
25 at both machines. While dedicated studies would need to be performed to ascertain that
26 backgrounds would be under control at CEPC, we expect CEPC's sensitivities to lepton-
27 flavor violating tau decays across the board at the level of 10^{-9} or better.

28 2.5.3 Flavor violating Z decays

29 Rare decays of the Z boson that violate quark flavor, $Z \rightarrow qq'$, are absent in the SM
30 at tree level and therefore strongly suppressed. The largest branching ratio in the SM is
31 expected to be $Z \rightarrow bs$ and can be estimated as $\text{BR}(Z \rightarrow bs) \sim \left| \frac{g^2}{16\pi^2} V_{tb} V_{ts}^* \right|^2 \times \text{BR}(Z \rightarrow$
32 $bb) \sim 10^{-9}$. Even with the statistics expected from 10^{12} Z bosons, a measurement of
33 the SM rate would be extremely challenging as the $Z \rightarrow bs$ events will be buried under
34 an enormous background from $Z \rightarrow q\bar{q}$ and $Z \rightarrow b\bar{b}$ decays. New physics can induce
35 effective quark-flavor violating Z couplings, but such effects are typically constrained by
36 rare meson decays and meson-mixing observables. Rates of $Z \rightarrow qq'$ that are far above
37 SM expectations are therefore unlikely.

38 Lepton-flavor violating decays are completely absent in the SM without neutrino masses.
39 Including neutrino masses, $Z \rightarrow \ell\ell'$ decays can in principle arise but the branching ra-
40 tios are suppressed by the tiny neutrino masses and predicted to be in the ballpark of
41 $10^{-50} - 10^{-60}$. However, new physics could enhance these branching ratios by many
42 orders of magnitude.

43 Searches at LEP established the following upper bounds using $\text{few} \times 10^6$ Z bosons [466–
44 468]: $\text{BR}(Z \rightarrow \mu e) < 1.7 \times 10^{-6}$, $\text{BR}(Z \rightarrow \tau e) < 9.8 \times 10^{-6}$, and $\text{BR}(Z \rightarrow \tau\mu) <$

1 1.2×10^{-5} . Due to the huge numbers of Z bosons produced at the LHC, searches at
 2 ATLAS and CMS for the clean $Z \rightarrow \mu e$ decay have recently set limits at the level
 3 of $\text{few} \times 10^{-7}$ [469, 470]. Searches for the final states with taus are more challenging
 4 at the LHC. The current ATLAS limits for $Z \rightarrow \tau e$ and $Z \rightarrow \tau \mu$ are at the level of
 5 $\text{few} \times 10^{-5}$ [471]. With the high statistics that are to be expected from the future LHC runs,
 6 it is conceivable that the bounds on lepton-flavor violating Z decays will improve by an
 7 order of magnitude or more.

Assuming that the sensitivities at the tera- Z factory of CEPC can be scaled from the
 LEP bounds with the square root of the number of produced Z bosons we find that with
 10^{12} Z bosons

$$\text{BR}(Z \rightarrow \mu e)_{\text{CEPC}} \lesssim 3 \times 10^{-9}, \quad (2.48)$$

$$\text{BR}(Z \rightarrow \tau e)_{\text{CEPC}} \lesssim 2 \times 10^{-8}, \quad (2.49)$$

$$\text{BR}(Z \rightarrow \tau \mu)_{\text{CEPC}} \lesssim 2 \times 10^{-8}. \quad (2.50)$$

8 This is a substantial improvement compared to existing and expected bounds. A more
 9 realistic analysis, including explicit background studies from e.g. $Z \rightarrow \tau \tau$ would need to
 10 be performed to provide a more precise estimate of the sensitivities [472]. Nevertheless,
 11 the above estimates indicate promising sensitivities to new-physics models that induce
 12 lepton-flavor violating Z decays, as for example extensions of the SM with heavy sterile
 13 neutrinos [283].

14 2.5.4 Summary

15 A CEPC that produces 10^{12} Z bosons provides large statistics samples of b and c hadrons
 16 as well as tau leptons in a clean experimental environment. This results to unique op-
 17 portunities for various flavor measurements that are unparalleled in current or any other
 18 future machine. For example, the observation of the rare tauonic decays $B \rightarrow K^* \tau^+ \tau^-$
 19 and $B_s \rightarrow \phi \tau^+ \tau^-$ at the SM rate could be achieved at CEPC, whereas the SM rates of
 20 such tauonic decays are not in reach of neither LHCb nor Belle II. It appears that sufficient
 21 statistics could be accumulated such that even an angular analysis of $B \rightarrow K^{(*)} \tau^+ \tau^-$ may
 22 be possible. CEPC should also achieve the world's best sensitivity to the related tauonic
 23 decay modes $B_s \rightarrow \tau^+ \tau^-$ and $B \rightarrow K \tau^+ \tau^-$ at a level of 10^{-5} . New physics in the rare
 24 tauonic decays is particularly well motivated given the current hints for lepton-flavor uni-
 25 versality violation in $R_{K^{(*)}}$ and $R_{D^{(*)}}$. A future circular electron-positron collider is also
 26 the only machine that would allow measurements of the rare FCNC decays of B_s mesons
 27 and Λ_b baryons to neutrinos, i.e., $B_s \rightarrow \phi \nu \bar{\nu}$ and $\Lambda_b \rightarrow \Lambda \nu \bar{\nu}$, with sensitivities of $\sim 10^{-6}$,
 28 thus complementing the sensitivity of Belle II to $B \rightarrow K^{(*)} \nu \bar{\nu}$.

29 A tera- Z factory of CEPC will also likely reach sensitivities to lepton-flavor violation
 30 in tau decays at a level of 10^{-9} , which is comparable to the sensitivities expected at Belle
 31 II. The leptonic decays of taus, $\tau \rightarrow \mu \nu \nu$ and $\tau \rightarrow e \nu \nu$ would be measured at CEPC
 32 with unprecedented precision, providing extremely sensitive tests of the weak interaction
 33 in tau decays. Furthermore, it may be possible to test lepton universality in $\tau \rightarrow \ell \nu \nu$
 34 at the level of 10^{-4} . Many new-physics explanations of the observed anomalies in $R_{K^{(*)}}$ and
 35 $R_{D^{(*)}}$ predict violation of lepton-flavor universality in tau decays at the permille level and
 36 could, therefore, be scrutinized at CEPC. Finally, the CEPC measurements would improve
 37 the bounds on lepton-flavor violating Z decays by orders of magnitude compared to the
 38 current best bounds from LEP, down to a level of 10^{-8} and better.

Observable	Current sensitivity	Future sensitivity	Tera- Z sensitivity
$\text{BR}(B_s \rightarrow \tau\tau)$	5.2×10^{-3} (LHCb)	$\sim 5 \times 10^{-4}$ (LHCb)	$\sim 10^{-5}$
$\text{BR}(B \rightarrow K^*\tau\tau)$	–	$\sim 10^{-5}$ (Belle II)	$\sim 10^{-8}$
$\text{BR}(B_s \rightarrow \phi\nu\bar{\nu})$	–	–	$\sim 10^{-6}$
$\text{BR}(\Lambda_b \rightarrow \Lambda\nu\bar{\nu})$	–	–	$\sim 10^{-6}$
$\text{BR}(\tau \rightarrow \mu\gamma)$	4.5×10^{-8} (Belle)	$\sim 10^{-9}$ (Belle II)	$\sim 10^{-9}$
$\frac{\text{BR}(\tau \rightarrow \mu\nu\bar{\nu})}{\text{BR}(\tau \rightarrow e\nu\bar{\nu})}$	3.9×10^{-3} (BaBar)	$\sim 10^{-3}$ (Belle II)	$\sim 10^{-4}$
$\text{BR}(Z \rightarrow \mu e)$	1.7×10^{-6} (LEP)	$\sim 10^{-8}$ (ATLAS/CMS)	$\sim 10^{-9}$
$\text{BR}(Z \rightarrow \tau e)$	9.8×10^{-6} (LEP)	$\sim 10^{-6}$ (ATLAS/CMS)	$\sim 10^{-8}$
$\text{BR}(Z \rightarrow \tau\mu)$	1.2×10^{-5} (LEP)	$\sim 10^{-6}$ (ATLAS/CMS)	$\sim 10^{-8}$

Table 2.5: Order of magnitude estimates of the sensitivity to a number of key observables for which the tera- Z factory at CEPC has unique capabilities. The expected future sensitivities assume luminosities of 50 fb^{-1} at LHCb, 50 ab^{-1} at Belle II, and 3 ab^{-1} at ATLAS and CMS. For the tera- Z factory of CEPC we have assumed the production of 10^{12} Z bosons.

1 Table 2.5, we summarize a number of key observables. All listed sensitivities are rough
2 estimates only and need to be followed up by dedicated sensitivity studies that carefully
3 take into account detection efficiencies, background systematics, etc.

4 References

- 5 [1] The ATLAS Collaboration, G. Aad et al., *Observation of a new particle in the*
6 *search for the Standard Model Higgs boson with the ATLAS detector at the LHC,*
7 *Phys. Lett. B* **716** (2012) 1–29, [arXiv:1207.7214 \[hep-ex\]](#).
- 8 [2] The CMS Collaboration, S. Chatrchyan et al., *Observation of a new boson at a*
9 *mass of 125 GeV with the CMS experiment at the LHC,* *Phys. Lett. B* **716** (2012)
10 **30–61**, [arXiv:1207.7235 \[hep-ex\]](#).
- 11 [3] ATLAS Collaboration, P. Glaysher, *ATLAS Higgs physics prospects at the high*
12 *luminosity LHC,* *PoS EPS-HEP2015* (2015) 160.
- 13 [4] P. A. M. Dirac, *New basis for cosmology,* *Proc. Roy. Soc. Lond.* **A165** (1938)
14 **199–208**.
- 15 [5] K. G. Wilson, *The Renormalization Group and Strong Interactions,* *Phys. Rev.* **D3**
16 **(1971) 1818**.
- 17 [6] L. Susskind, *Dynamics of Spontaneous Symmetry Breaking in the Weinberg-Salam*
18 *Theory,* *Phys. Rev.* **D20** (1979) 2619–2625.

- [7] G. 't Hooft, *Naturalness, chiral symmetry, and spontaneous chiral symmetry breaking*, *NATO Sci. Ser. B* **59** (1980) 135–157.
- [8] P. Fayet, *Supersymmetry and Weak, Electromagnetic and Strong Interactions*, *Phys. Lett.* **64B** (1976) 159.
- [9] P. Fayet, *Spontaneously Broken Supersymmetric Theories of Weak, Electromagnetic and Strong Interactions*, *Phys. Lett.* **69B** (1977) 489.
- [10] S. Dimopoulos and H. Georgi, *Softly Broken Supersymmetry and SU(5)*, *Nucl. Phys.* **B193** (1981) 150–162.
- [11] D. B. Kaplan, H. Georgi, and S. Dimopoulos, *Composite Higgs Scalars*, *Phys. Lett.* **136B** (1984) 187–190.
- [12] N. Arkani-Hamed, A. G. Cohen, E. Katz, A. E. Nelson, T. Gregoire, and J. G. Wacker, *The Minimal moose for a little Higgs*, *JHEP* **08** (2002) 021, [arXiv:hep-ph/0206020](https://arxiv.org/abs/hep-ph/0206020) [hep-ph].
- [13] *Composite Higgses*, *Eur. Phys. J.* **C74** (2014) no. 5, 2766, [arXiv:1401.2457](https://arxiv.org/abs/1401.2457) [hep-ph].
- [14] S. Weinberg, *Implications of Dynamical Symmetry Breaking*, *Phys. Rev.* **D13** (1976) 974–996. [Addendum: *Phys. Rev.* **D19**, 1277(1979)].
- [15] N. Arkani-Hamed, S. Dimopoulos, and G. R. Dvali, *The Hierarchy problem and new dimensions at a millimeter*, *Phys. Lett.* **B429** (1998) 263–272, [arXiv:hep-ph/9803315](https://arxiv.org/abs/hep-ph/9803315) [hep-ph].
- [16] I. Antoniadis, N. Arkani-Hamed, S. Dimopoulos, and G. R. Dvali, *New dimensions at a millimeter to a Fermi and superstrings at a TeV*, *Phys. Lett.* **B436** (1998) 257–263, [arXiv:hep-ph/9804398](https://arxiv.org/abs/hep-ph/9804398) [hep-ph].
- [17] L. Randall and R. Sundrum, *A Large mass hierarchy from a small extra dimension*, *Phys. Rev. Lett.* **83** (1999) 3370–3373, [arXiv:hep-ph/9905221](https://arxiv.org/abs/hep-ph/9905221) [hep-ph].
- [18] L. Randall and R. Sundrum, *An Alternative to compactification*, *Phys. Rev. Lett.* **83** (1999) 4690–4693, [arXiv:hep-th/9906064](https://arxiv.org/abs/hep-th/9906064) [hep-th].
- [19] P. W. Graham, D. E. Kaplan, and S. Rajendran, *Cosmological Relaxation of the Electroweak Scale*, *Phys. Rev. Lett.* **115** (2015) no. 22, 221801, [arXiv:1504.07551](https://arxiv.org/abs/1504.07551) [hep-ph].
- [20] J. Gu, H. Li, Z. Liu, S. Su, and W. Su, *Learning from Higgs Physics at Future Higgs Factories*, *JHEP* **12** (2017) 153, [arXiv:1709.06103](https://arxiv.org/abs/1709.06103) [hep-ph].
- [21] A. Djouadi, L. Maiani, G. Moreau, A. Polosa, J. Quevillon, and V. Riquer, *The post-Higgs MSSM scenario: Habemus MSSM?*, *Eur. Phys. J.* **C73** (2013) 2650, [arXiv:1307.5205](https://arxiv.org/abs/1307.5205) [hep-ph].
- [22] J. Baglio, A. Djouadi, and J. Quevillon, *Prospects for Higgs physics at energies up to 100 TeV*, *Rept. Prog. Phys.* **79** (2016) no. 11, 116201, [arXiv:1511.07853](https://arxiv.org/abs/1511.07853) [hep-ph].

- 1 [23] J. Fan, M. Reece, and L.-T. Wang, *Precision Natural SUSY at CEPC, FCC-ee, and*
2 *ILC*, **JHEP** **08** (2015) 152, [arXiv:1412.3107 \[hep-ph\]](#).
- 3 [24] J. Fan and M. Reece, *A New Look at Higgs Constraints on Stops*, **JHEP** **06** (2014)
4 **031**, [arXiv:1401.7671 \[hep-ph\]](#).
- 5 [25] N. Craig, M. Farina, M. McCullough, and M. Perelstein, *Precision Higgsstrahlung*
6 *as a Probe of New Physics*, **JHEP** **03** (2015) 146, [arXiv:1411.0676](#)
7 [\[hep-ph\]](#).
- 8 [26] R. Essig, P. Meade, H. Ramani, and Y.-M. Zhong, *Higgs-Precision Constraints on*
9 *Colored Naturalness*, **JHEP** **09** (2017) 085, [arXiv:1707.03399 \[hep-ph\]](#).
- 10 [27] G. F. Giudice, C. Grojean, A. Pomarol, and R. Rattazzi, *The Strongly-Interacting*
11 *Light Higgs*, **JHEP** **06** (2007) 045, [arXiv:hep-ph/0703164 \[hep-ph\]](#).
- 12 [28] A. Thamm, R. Torre, and A. Wulzer, *Future tests of Higgs compositeness: direct*
13 *vs indirect*, **JHEP** **07** (2015) 100, [arXiv:1502.01701 \[hep-ph\]](#).
- 14 [29] N. Craig, S. Knapen, and P. Longhi, *Neutral Naturalness from Orbifold Higgs*
15 *Models*, **Phys. Rev. Lett.** **114** (2015) no. 6, 061803, [arXiv:1410.6808](#)
16 [\[hep-ph\]](#).
- 17 [30] G. Burdman, Z. Chacko, H.-S. Goh, and R. Harnik, *Folded supersymmetry and the*
18 *LEP paradox*, **JHEP** **02** (2007) 009, [arXiv:hep-ph/0609152 \[hep-ph\]](#).
- 19 [31] Z. Chacko, H.-S. Goh, and R. Harnik, *The Twin Higgs: Natural electroweak*
20 *breaking from mirror symmetry*, **Phys. Rev. Lett.** **96** (2006) 231802,
21 [arXiv:hep-ph/0506256 \[hep-ph\]](#).
- 22 [32] T. Cohen, N. Craig, G. F. Giudice, and M. McCullough, *The Hyperbolic Higgs*,
23 **JHEP** **05** (2018) 091, [arXiv:1803.03647 \[hep-ph\]](#).
- 24 [33] H. Cai, H.-C. Cheng, and J. Terning, *A Quirky Little Higgs Model*, **JHEP** **05**
25 **(2009) 045**, [arXiv:0812.0843 \[hep-ph\]](#).
- 26 [34] N. Craig, C. Englert, and M. McCullough, *New Probe of Naturalness*, **Phys. Rev.**
27 **Lett.** **111** (2013) no. 12, 121803, [arXiv:1305.5251 \[hep-ph\]](#).
- 28 [35] T. Flacke, C. Frugiuele, E. Fuchs, R. S. Gupta, and G. Perez, *Phenomenology of*
29 *relaxion-Higgs mixing*, **JHEP** **06** (2017) 050, [arXiv:1610.02025](#)
30 [\[hep-ph\]](#).
- 31 [36] K. Choi and S. H. Im, *Constraints on Relaxion Windows*, **JHEP** **12** (2016) 093,
32 [arXiv:1610.00680 \[hep-ph\]](#).
- 33 [37] X.-m. Zhang, *Operators analysis for Higgs potential and cosmological bound on*
34 *Higgs mass*, **Phys. Rev.** **D47** (1993) 3065–3067, [arXiv:hep-ph/9301277](#)
35 [\[hep-ph\]](#).
- 36 [38] C. Grojean, G. Servant, and J. D. Wells, *First-order electroweak phase transition*
37 *in the standard model with a low cutoff*, **Phys. Rev.** **D71** (2005) 036001,
38 [arXiv:hep-ph/0407019 \[hep-ph\]](#).

- [39] C. Delaunay, C. Grojean, and J. D. Wells, *Dynamics of Non-renormalizable Electroweak Symmetry Breaking*, **JHEP** **04** (2008) 029, [arXiv:0711.2511 \[hep-ph\]](#).
- [40] Q.-H. Cao, F. P. Huang, K.-P. Xie, and X. Zhang, *Testing the electroweak phase transition in scalar extension models at lepton colliders*, **Chin. Phys.** **C42** (2018) no. 2, 023103, [arXiv:1708.04737 \[hep-ph\]](#).
- [41] F. P. Huang, P.-H. Gu, P.-F. Yin, Z.-H. Yu, and X. Zhang, *Testing the electroweak phase transition and electroweak baryogenesis at the LHC and a circular electron-positron collider*, **Phys. Rev.** **D93** (2016) no. 10, 103515, [arXiv:1511.03969 \[hep-ph\]](#).
- [42] F. P. Huang, Y. Wan, D.-G. Wang, Y.-F. Cai, and X. Zhang, *Hearing the echoes of electroweak baryogenesis with gravitational wave detectors*, **Phys. Rev.** **D94** (2016) no. 4, 041702, [arXiv:1601.01640 \[hep-ph\]](#).
- [43] S. R. Coleman and E. J. Weinberg, *Radiative Corrections as the Origin of Spontaneous Symmetry Breaking*, **Phys.Rev.** **D7** (1973) 1888–1910.
- [44] J. R. Espinosa and M. Quiros, *Novel Effects in Electroweak Breaking from a Hidden Sector*, **Phys. Rev.** **D76** (2007) 076004, [arXiv:hep-ph/0701145 \[hep-ph\]](#).
- [45] C. Caprini et al., *Science with the space-based interferometer eLISA. II: Gravitational waves from cosmological phase transitions*, **JCAP** **1604** (2016) no. 04, 001, [arXiv:1512.06239 \[astro-ph.CO\]](#).
- [46] A. G. Cohen, D. Kaplan, and A. Nelson, *Progress in electroweak baryogenesis*, **Ann.Rev.Nucl.Part.Sci.** **43** (1993) 27–70, [arXiv:hep-ph/9302210 \[hep-ph\]](#).
- [47] M. Carena, M. Quiros, and C. E. M. Wagner, *Opening the window for electroweak baryogenesis*, **Phys. Lett.** **B380** (1996) 81–91, [arXiv:hep-ph/9603420 \[hep-ph\]](#).
- [48] J. R. Espinosa, *Dominant two loop corrections to the MSSM finite temperature effective potential*, **Nucl. Phys.** **B475** (1996) 273–292, [arXiv:hep-ph/9604320 \[hep-ph\]](#).
- [49] T. Cohen, D. E. Morrissey, and A. Pierce, *Electroweak Baryogenesis and Higgs Signatures*, **Phys. Rev.** **D86** (2012) 013009, [arXiv:1203.2924 \[hep-ph\]](#).
- [50] D. Curtin, P. Jaiswal, and P. Meade, *Excluding Electroweak Baryogenesis in the MSSM*, **JHEP** **08** (2012) 005, [arXiv:1203.2932 \[hep-ph\]](#).
- [51] D. J. H. Chung, A. J. Long, and L.-T. Wang, *125 GeV Higgs boson and electroweak phase transition model classes*, **Phys. Rev.** **D87** (2013) no. 2, 023509, [arXiv:1209.1819 \[hep-ph\]](#).
- [52] J. R. Espinosa and M. Quiros, *The Electroweak phase transition with a singlet*, **Phys. Lett.** **B305** (1993) 98–105, [arXiv:hep-ph/9301285 \[hep-ph\]](#).

- 1 [53] J. Choi and R. R. Volkas, *Real Higgs singlet and the electroweak phase transition*
2 *in the Standard Model*, *Phys. Lett.* **B317** (1993) 385–391,
3 [arXiv:hep-ph/9308234](#) [hep-ph].
- 4 [54] J. McDonald, *Electroweak baryogenesis and dark matter via a gauge singlet*
5 *scalar*, *Phys. Lett.* **B323** (1994) 339–346.
- 6 [55] S. Profumo, M. J. Ramsey-Musolf, and G. Shaughnessy, *Singlet Higgs*
7 *phenomenology and the electroweak phase transition*, *JHEP* **08** (2007) 010,
8 [arXiv:0705.2425](#) [hep-ph].
- 9 [56] D. Curtin, P. Meade, and C.-T. Yu, *Testing Electroweak Baryogenesis with Future*
10 *Colliders*, *JHEP* **11** (2014) 127, [arXiv:1409.0005](#) [hep-ph].
- 11 [57] D. Curtin, P. Meade, and H. Ramani, *Thermal Resummation and Phase*
12 *Transitions*, [arXiv:1612.00466](#) [hep-ph].
- 13 [58] M. McCullough, *An Indirect Model-Dependent Probe of the Higgs Self-Coupling*,
14 *Phys. Rev.* **D90** (2014) no. 1, 015001, [arXiv:1312.3322](#) [hep-ph].
15 [Erratum: *Phys. Rev.* **D92**, no. 3, 039903 (2015)].
- 16 [59] P. Huang, A. J. Long, and L.-T. Wang, *Probing the Electroweak Phase Transition*
17 *with Higgs Factories and Gravitational Waves*, *Phys. Rev.* **D94** (2016) no. 7,
18 [075008](#), [arXiv:1608.06619](#) [hep-ph].
- 19 [60] S. Profumo, M. J. Ramsey-Musolf, C. L. Wainwright, and P. Winslow,
20 *Singlet-catalyzed electroweak phase transitions and precision Higgs boson*
21 *studies*, *Phys. Rev.* **D91** (2015) no. 3, 035018, [arXiv:1407.5342](#)
22 [hep-ph].
- 23 [61] A. Noble and M. Perelstein, *Higgs self-coupling as a probe of electroweak phase*
24 *transition*, *Phys. Rev.* **D78** (2008) 063518, [arXiv:0711.3018](#) [hep-ph].
- 25 [62] V. Silveira and A. Zee, *Scalar Phantoms*, *Phys. Lett.* **161B** (1985) 136–140.
- 26 [63] J. McDonald, *Gauge singlet scalars as cold dark matter*, *Phys. Rev.* **D50** (1994)
27 [3637–3649](#), [arXiv:hep-ph/0702143](#) [HEP-PH].
- 28 [64] C. P. Burgess, M. Pospelov, and T. ter Veldhuis, *The Minimal model of*
29 *nonbaryonic dark matter: A Singlet scalar*, *Nucl. Phys.* **B619** (2001) 709–728,
30 [arXiv:hep-ph/0011335](#) [hep-ph].
- 31 [65] B. Patt and F. Wilczek, *Higgs-field portal into hidden sectors*,
32 [arXiv:hep-ph/0605188](#) [hep-ph].
- 33 [66] Y. G. Kim and K. Y. Lee, *The Minimal model of fermionic dark matter*, *Phys. Rev.*
34 **D75** (2007) 115012, [arXiv:hep-ph/0611069](#) [hep-ph].
- 35 [67] V. Barger, P. Langacker, M. McCaskey, M. J. Ramsey-Musolf, and
36 G. Shaughnessy, *LHC Phenomenology of an Extended Standard Model with a*
37 *Real Scalar Singlet*, *Phys. Rev.* **D77** (2008) 035005, [arXiv:0706.4311](#)
38 [hep-ph].

- 1 [68] Y. G. Kim, K. Y. Lee, and S. Shin, *Singlet fermionic dark matter*, *JHEP* **05** (2008)
2 [100](#), [arXiv:0803.2932](#) [hep-ph].
- 3 [69] J. M. Cline, K. Kainulainen, P. Scott, and C. Weniger, *Update on scalar singlet*
4 *dark matter*, *Phys. Rev.* **D88** (2013) 055025, [arXiv:1306.4710](#) [hep-ph].
5 [Erratum: *Phys. Rev.*D92,no.3,039906(2015)].
- 6 [70] L. B. Okun, *Limits of Electrodynamics: Paraphotons?*, *Sov. Phys. JETP* **56** (1982)
7 502. [*Zh. Eksp. Teor. Fiz.*83,892(1982)].
- 8 [71] B. Holdom, *Two U(1)'s and Epsilon Charge Shifts*, *Phys. Lett.* **166B** (1986)
9 [196–198](#).
- 10 [72] K. R. Dienes, C. F. Kolda, and J. March-Russell, *Kinetic mixing and the*
11 *supersymmetric gauge hierarchy*, *Nucl. Phys.* **B492** (1997) 104–118,
12 [arXiv:hep-ph/9610479](#) [hep-ph].
- 13 [73] M. Pospelov, A. Ritz, and M. B. Voloshin, *Secluded WIMP Dark Matter*, *Phys.*
14 *Lett.* **B662** (2008) 53–61, [arXiv:0711.4866](#) [hep-ph].
- 15 [74] N. Arkani-Hamed and N. Weiner, *LHC Signals for a SuperUnified Theory of Dark*
16 *Matter*, *JHEP* **12** (2008) 104, [arXiv:0810.0714](#) [hep-ph].
- 17 [75] N. Arkani-Hamed, D. P. Finkbeiner, T. R. Slatyer, and N. Weiner, *A Theory of*
18 *Dark Matter*, *Phys. Rev.* **D79** (2009) 015014, [arXiv:0810.0713](#) [hep-ph].
- 19 [76] M. Pospelov, *Secluded U(1) below the weak scale*, *Phys. Rev.* **D80** (2009) 095002,
20 [arXiv:0811.1030](#) [hep-ph].
- 21 [77] P. Minkowski, $\mu \rightarrow e\gamma$ at a Rate of One Out of 10^9 Muon Decays?, *Phys. Lett.*
22 **67B** (1977) 421–428.
- 23 [78] R. N. Mohapatra and G. Senjanovic, *Neutrino Mass and Spontaneous Parity*
24 *Violation*, *Phys. Rev. Lett.* **44** (1980) 912.
- 25 [79] S. Dodelson and L. M. Widrow, *Sterile-neutrinos as dark matter*, *Phys. Rev. Lett.*
26 **72** (1994) 17–20, [arXiv:hep-ph/9303287](#) [hep-ph].
- 27 [80] X.-D. Shi and G. M. Fuller, *A New dark matter candidate: Nonthermal sterile*
28 *neutrinos*, *Phys. Rev. Lett.* **82** (1999) 2832–2835,
29 [arXiv:astro-ph/9810076](#) [astro-ph].
- 30 [81] D. E. Kaplan, M. A. Luty, and K. M. Zurek, *Asymmetric Dark Matter*, *Phys. Rev.*
31 **D79** (2009) 115016, [arXiv:0901.4117](#) [hep-ph].
- 32 [82] A. Falkowski, J. Juknevich, and J. Shelton, *Dark Matter Through the Neutrino*
33 *Portal*, [arXiv:0908.1790](#) [hep-ph].
- 34 [83] J. F. Cherry, A. Friedland, and I. M. Shoemaker, *Neutrino Portal Dark Matter:*
35 *From Dwarf Galaxies to IceCube*, [arXiv:1411.1071](#) [hep-ph].
- 36 [84] J. A. Harvey, C. T. Hill, and R. J. Hill, *Standard Model Gauging of the*
37 *Wess-Zumino-Witten Term: Anomalies, Global Currents and*

- 1 *pseudo-Chern-Simons Interactions*, *Phys. Rev.* **D77** (2008) 085017,
2 [arXiv:0712.1230 \[hep-th\]](#).
- 3 [85] R. J. Hill, *Some new implications of the anomalous baryon current in the Standard*
4 *Model*, in *Proceedings, 43rd Rencontres de Moriond on Electroweak Interactions*
5 *and Unified Theories: La Thuile, Italy, March 1-8, 2008*, pp. 355–362. 2008.
6 [arXiv:0806.3673 \[hep-ph\]](#).
7 http://lss.fnal.gov/cgi-bin/find_paper.pl?conf-08-202.
- 8 [86] A. Dedes and K. Suxho, *Heavy Fermion Non-Decoupling Effects in Triple Gauge*
9 *Boson Vertices*, *Phys. Rev.* **D85** (2012) 095024, [arXiv:1202.4940](#)
10 [\[hep-ph\]](#).
- 11 [87] B. Batell, P. deNiverville, D. McKeen, M. Pospelov, and A. Ritz, *Leptophobic*
12 *Dark Matter at Neutrino Factories*, *Phys. Rev.* **D90** (2014) no. 11, 115014,
13 [arXiv:1405.7049 \[hep-ph\]](#).
- 14 [88] J. A. Dror, R. Lasenby, and M. Pospelov, *New constraints on light vectors coupled*
15 *to anomalous currents*, *Phys. Rev. Lett.* **119** (2017) no. 14, 141803,
16 [arXiv:1705.06726 \[hep-ph\]](#).
- 17 [89] A. Ismail, A. Katz, and D. Racco, *On dark matter interactions with the Standard*
18 *Model through an anomalous Z'* , *JHEP* **10** (2017) 165, [arXiv:1707.00709](#)
19 [\[hep-ph\]](#).
- 20 [90] J. A. Dror, R. Lasenby, and M. Pospelov, *Dark forces coupled to nonconserved*
21 *currents*, *Phys. Rev.* **D96** (2017) no. 7, 075036, [arXiv:1707.01503](#)
22 [\[hep-ph\]](#).
- 23 [91] A. Ismail and A. Katz, *Anomalous Z' and Diboson Resonances at the LHC*,
24 [arXiv:1712.01840 \[hep-ph\]](#).
- 25 [92] A. Ekstedt, R. Enberg, G. Ingelman, J. Löfgren, and T. Mandal, *Minimal*
26 *anomalous U(1) theories and collider phenomenology*, [arXiv:1712.03410](#)
27 [\[hep-ph\]](#).
- 28 [93] M. Fabbrichesi, E. Gabrielli, and B. Mele, *Z boson decay into light and darkness*,
29 [arXiv:1712.05412 \[hep-ph\]](#).
- 30 [94] R. D. Peccei and H. R. Quinn, *CP Conservation in the Presence of Instantons*,
31 *Phys. Rev. Lett.* **38** (1977) 1440–1443.
- 32 [95] S. Weinberg, *A New Light Boson?*, *Phys. Rev. Lett.* **40** (1978) 223–226.
- 33 [96] F. Wilczek, *Problem of Strong p and t Invariance in the Presence of Instantons*,
34 *Phys. Rev. Lett.* **40** (1978) 279–282.
- 35 [97] J. M. Frere, D. R. T. Jones, and S. Raby, *Fermion Masses and Induction of the*
36 *Weak Scale by Supergravity*, *Nucl. Phys.* **B222** (1983) 11–19.
- 37 [98] A. E. Nelson and N. Seiberg, *R symmetry breaking versus supersymmetry*
38 *breaking*, *Nucl. Phys.* **B416** (1994) 46–62, [arXiv:hep-ph/9309299](#)
39 [\[hep-ph\]](#).

- [99] J. Bagger, E. Poppitz, and L. Randall, *The R axion from dynamical supersymmetry breaking*, *Nucl. Phys.* **B426** (1994) 3–18, [arXiv:hep-ph/9405345](#) [hep-ph].
- [100] J. P. Conlon, *The QCD axion and moduli stabilisation*, *JHEP* **05** (2006) 078, [arXiv:hep-th/0602233](#) [hep-th].
- [101] P. Svrcek and E. Witten, *Axions In String Theory*, *JHEP* **06** (2006) 051, [arXiv:hep-th/0605206](#) [hep-th].
- [102] Y. Nomura and J. Thaler, *Dark Matter through the Axion Portal*, *Phys. Rev.* **D79** (2009) 075008, [arXiv:0810.5397](#) [hep-ph].
- [103] A. Arvanitaki, S. Dimopoulos, S. Dubovsky, N. Kaloper, and J. March-Russell, *String Axiverse*, *Phys. Rev.* **D81** (2010) 123530, [arXiv:0905.4720](#) [hep-th].
- [104] J. Jaeckel and A. Ringwald, *The Low-Energy Frontier of Particle Physics*, *Ann. Rev. Nucl. Part. Sci.* **60** (2010) 405–437, [arXiv:1002.0329](#) [hep-ph].
- [105] B. S. Acharya, K. Bobkov, and P. Kumar, *An M Theory Solution to the Strong CP Problem and Constraints on the Axiverse*, *JHEP* **11** (2010) 105, [arXiv:1004.5138](#) [hep-th].
- [106] A. Ringwald, *Exploring the Role of Axions and Other WISPs in the Dark Universe*, *Phys. Dark Univ.* **1** (2012) 116–135, [arXiv:1210.5081](#) [hep-ph].
- [107] K. Sigurdson, M. Doran, A. Kurylov, R. R. Caldwell, and M. Kamionkowski, *Dark-matter electric and magnetic dipole moments*, *Phys. Rev.* **D70** (2004) 083501, [arXiv:astro-ph/0406355](#) [astro-ph]. [Erratum: *Phys. Rev.* **D73**, 089903(2006)].
- [108] E. Mazzo, S. Mohanty, and S. Rao, *Dipolar Dark Matter*, *Phys. Rev.* **D80** (2009) 036009, [arXiv:0906.1979](#) [hep-ph].
- [109] S. Chang, N. Weiner, and I. Yavin, *Magnetic Inelastic Dark Matter*, *Phys. Rev.* **D82** (2010) 125011, [arXiv:1007.4200](#) [hep-ph].
- [110] N. Weiner and I. Yavin, *How Dark Are Majorana WIMPs? Signals from MiDM and Rayleigh Dark Matter*, *Phys. Rev.* **D86** (2012) 075021, [arXiv:1206.2910](#) [hep-ph].
- [111] N. Weiner and I. Yavin, *UV completions of magnetic inelastic and Rayleigh dark matter for the Fermi Line(s)*, *Phys. Rev.* **D87** (2013) no. 2, 023523, [arXiv:1209.1093](#) [hep-ph].
- [112] D. Curtin et al., *Exotic decays of the 125 GeV Higgs boson*, *Phys. Rev.* **D90** (2014) no. 7, 075004, [arXiv:1312.4992](#) [hep-ph].
- [113] LHC Higgs Cross Section Working Group Collaboration, D. de Florian et al., *Handbook of LHC Higgs Cross Sections: 4. Deciphering the Nature of the Higgs Sector*, [arXiv:1610.07922](#) [hep-ph].

- [114] Z. Liu, L.-T. Wang, and H. Zhang, *Exotic decays of the 125 GeV Higgs boson at future e^+e^- lepton colliders*, *Chin. Phys.* **C41** (2017) no. 6, 063102, [arXiv:1612.09284 \[hep-ph\]](#).
- [115] J. Liu, L.-T. Wang, X.-P. Wang, and W. Xue, *Exposing Dark Sector with Future Z-Factories*, [arXiv:1712.07237 \[hep-ph\]](#).
- [116] W.-F. Chang, J. N. Ng, and G. White, *Prospects for Detecting light bosons at the FCC-ee and CEPC*, [arXiv:1803.00148 \[hep-ph\]](#).
- [117] L3 Collaboration, M. Acciarri et al., *Search for neutral Higgs boson production through the process $e^+e^- \rightarrow Z^*H0$* , *Phys. Lett.* **B385** (1996) 454–470.
- [118] ATLAS, CMS Collaboration, G. Aad et al., *Measurements of the Higgs boson production and decay rates and constraints on its couplings from a combined ATLAS and CMS analysis of the LHC pp collision data at $\sqrt{s} = 7$ and 8 TeV*, *JHEP* **08** (2016) 045, [arXiv:1606.02266 \[hep-ex\]](#).
- [119] S. Dawson et al., *Working Group Report: Higgs Boson*, in *Proceedings, 2013 Community Summer Study on the Future of U.S. Particle Physics: Snowmass on the Mississippi (CSS2013): Minneapolis, MN, USA, July 29-August 6, 2013*. 2013. [arXiv:1310.8361 \[hep-ex\]](#).
<http://inspirehep.net/record/1262795/files/arXiv:1310.8361.pdf>.
- [120] TLEP Design Study Working Group Collaboration, M. Bicer et al., *First Look at the Physics Case of TLEP*, *JHEP* **01** (2014) 164, [arXiv:1308.6176 \[hep-ex\]](#).
- [121] CEPC-SPPC Study Group Collaboration, *CEPC-SPPC Preliminary Conceptual Design Report. 1. Physics and Detector*, .
http://cepc.ihep.ac.cn/preCDR/main_preCDR.pdf.
- [122] M. Ruan, *Higgs Measurement at e^+e^- Circular Colliders*, *Nucl. Part. Phys. Proc.* **273-275** (2016) 857–862, [arXiv:1411.5606 \[hep-ex\]](#).
- [123] J. Liu, X.-P. Wang, and F. Yu, *A Tale of Two Portals: Testing Light, Hidden New Physics at Future e^+e^- Colliders*, *JHEP* **06** (2017) 077, [arXiv:1704.00730 \[hep-ph\]](#).
- [124] ATLAS Collaboration, G. Aad et al., *Constraints on new phenomena via Higgs boson couplings and invisible decays with the ATLAS detector*, *JHEP* **11** (2015) 206, [arXiv:1509.00672 \[hep-ex\]](#).
- [125] CMS Collaboration, V. Khachatryan et al., *Searches for invisible decays of the Higgs boson in pp collisions at $\sqrt{s} = 7, 8, \text{ and } 13$ TeV*, *JHEP* **02** (2017) 135, [arXiv:1610.09218 \[hep-ex\]](#).
- [126] *Projections for measurements of Higgs boson cross sections, branching ratios and coupling parameters with the ATLAS detector at a HL-LHC*, ATL-PHYS-PUB-2013-014, CERN, Geneva, Oct, 2013.
<http://cds.cern.ch/record/1611186>.

- [127] CMS Collaboration, *Projected Performance of an Upgraded CMS Detector at the LHC and HL-LHC: Contribution to the Snowmass Process*, in *Proceedings, 2013 Community Summer Study on the Future of U.S. Particle Physics: Snowmass on the Mississippi (CSS2013): Minneapolis, MN, USA, July 29-August 6, 2013*. 2013. [arXiv:1307.7135 \[hep-ex\]](https://arxiv.org/abs/1307.7135).
<https://inspirehep.net/record/1244669/files/arXiv:1307.7135.pdf>.
- [128] K. Fujii et al., *Physics Case for the 250 GeV Stage of the International Linear Collider*, [arXiv:1710.07621 \[hep-ex\]](https://arxiv.org/abs/1710.07621).
- [129] Planck Collaboration, P. A. R. Ade et al., *Planck 2015 results. XIII. Cosmological parameters*, *Astron. Astrophys.* **594** (2016) A13, [arXiv:1502.01589 \[astro-ph.CO\]](https://arxiv.org/abs/1502.01589).
- [130] XENON Collaboration, E. Aprile et al., *First Dark Matter Search Results from the XENON1T Experiment*, *Phys. Rev. Lett.* **119** (2017) no. 18, 181301, [arXiv:1705.06655 \[astro-ph.CO\]](https://arxiv.org/abs/1705.06655).
- [131] LUX Collaboration, D. S. Akerib et al., *Results from a search for dark matter in the complete LUX exposure*, *Phys. Rev. Lett.* **118** (2017) no. 2, 021303, [arXiv:1608.07648 \[astro-ph.CO\]](https://arxiv.org/abs/1608.07648).
- [132] PandaX-II Collaboration, A. Tan et al., *Dark Matter Results from First 98.7 Days of Data from the PandaX-II Experiment*, *Phys. Rev. Lett.* **117** (2016) no. 12, 121303, [arXiv:1607.07400 \[hep-ex\]](https://arxiv.org/abs/1607.07400).
- [133] CRESST Collaboration, G. Angloher et al., *Results on light dark matter particles with a low-threshold CRESST-II detector*, *Eur. Phys. J.* **C76** (2016) no. 1, 25, [arXiv:1509.01515 \[astro-ph.CO\]](https://arxiv.org/abs/1509.01515).
- [134] J. Jaeckel and M. Spannowsky, *Probing MeV to 90 GeV axion-like particles with LEP and LHC*, *Phys. Lett.* **B753** (2016) 482–487, [arXiv:1509.00476 \[hep-ph\]](https://arxiv.org/abs/1509.00476).
- [135] OPAL Collaboration, G. Abbiendi et al., *Multiphoton production in e^+e^- collisions at $s^{*(1/2)} = 181\text{-GeV}$ to 209-GeV* , *Eur. Phys. J.* **C26** (2003) 331–344, [arXiv:hep-ex/0210016 \[hep-ex\]](https://arxiv.org/abs/hep-ex/0210016).
- [136] ATLAS Collaboration, G. Aad et al., *Search for Scalar Diphoton Resonances in the Mass Range 65 – 600 GeV with the ATLAS Detector in pp Collision Data at $\sqrt{s} = 8\text{ TeV}$* , *Phys. Rev. Lett.* **113** (2014) no. 17, 171801, [arXiv:1407.6583 \[hep-ex\]](https://arxiv.org/abs/1407.6583).
- [137] ATLAS Collaboration, G. Aad et al., *Search for new phenomena in events with at least three photons collected in pp collisions at $\sqrt{s} = 8\text{ TeV}$ with the ATLAS detector*, *Eur. Phys. J.* **C76** (2016) no. 4, 210, [arXiv:1509.05051 \[hep-ex\]](https://arxiv.org/abs/1509.05051).
- [138] S. Knapen, T. Lin, H. K. Lou, and T. Melia, *Searching for Axionlike Particles with Ultraperipheral Heavy-Ion Collisions*, *Phys. Rev. Lett.* **118** (2017) no. 17, 171801, [arXiv:1607.06083 \[hep-ph\]](https://arxiv.org/abs/1607.06083).

- [139] L3 Collaboration, M. Acciarri et al., *Search for new physics in energetic single photon production in e^+e^- annihilation at the Z resonance*, *Phys. Lett.* **B412** (1997) 201–209.
- [140] J. Fan, M. Reece, and L.-T. Wang, *Possible Futures of Electroweak Precision: ILC, FCC-ee, and CEPC*, *JHEP* **09** (2015) 196, [arXiv:1411.1054 \[hep-ph\]](#).
- [141] L. Bian, J. Shu, and Y. Zhang, *Prospects for Triple Gauge Coupling Measurements at Future Lepton Colliders and the 14 TeV LHC*, *JHEP* **09** (2015) 206, [arXiv:1507.02238 \[hep-ph\]](#).
- [142] J. Ellis and T. You, *Sensitivities of Prospective Future $e+e-$ Colliders to Decoupled New Physics*, *JHEP* **03** (2016) 089, [arXiv:1510.04561 \[hep-ph\]](#).
- [143] S.-F. Ge, H.-J. He, and R.-Q. Xiao, *Probing new physics scales from Higgs and electroweak observables at e^+e^- Higgs factory*, *JHEP* **10** (2016) 007, [arXiv:1603.03385 \[hep-ph\]](#).
- [144] S.-F. Ge, H.-J. He, and R.-Q. Xiao, *Testing Higgs coupling precision and new physics scales at lepton colliders*, *Int. J. Mod. Phys.* **A31** (2016) no. 33, 1644004, [arXiv:1612.02718 \[hep-ph\]](#). [,55(2017)].
- [145] G. Durieux, C. Grojean, J. Gu, and K. Wang, *The leptonic future of the Higgs*, *JHEP* **09** (2017) 014, [arXiv:1704.02333 \[hep-ph\]](#).
- [146] W. H. Chiu, S. C. Leung, T. Liu, K.-F. Lyu, and L.-T. Wang, *Probing 6D operators at future e^-e^+ colliders*, *JHEP* **05** (2018) 081, [arXiv:1711.04046 \[hep-ph\]](#).
- [147] M. A. Fedderke, T. Lin, and L.-T. Wang, *Probing the fermionic Higgs portal at lepton colliders*, *JHEP* **04** (2016) 160, [arXiv:1506.05465 \[hep-ph\]](#).
- [148] C. Cai, Z.-H. Yu, and H.-H. Zhang, *CEPC Precision of Electroweak Oblique Parameters and Weakly Interacting Dark Matter: the Fermionic Case*, *Nucl. Phys.* **B921** (2017) 181–210, [arXiv:1611.02186 \[hep-ph\]](#).
- [149] N. Liu and L. Wu, *An indirect probe of the higgsino world at the CEPC*, *Eur. Phys. J.* **C77** (2017) no. 12, 868, [arXiv:1705.02534 \[hep-ph\]](#).
- [150] C. Cai, Z.-H. Yu, and H.-H. Zhang, *CEPC Precision of Electroweak Oblique Parameters and Weakly Interacting Dark Matter: the Scalar Case*, *Nucl. Phys.* **B924** (2017) 128–152, [arXiv:1705.07921 \[hep-ph\]](#).
- [151] Q.-F. Xiang, X.-J. Bi, P.-F. Yin, and Z.-H. Yu, *Exploring Fermionic Dark Matter via Higgs Boson Precision Measurements at the Circular Electron Positron Collider*, *Phys. Rev.* **D97** (2018) no. 5, 055004, [arXiv:1707.03094 \[hep-ph\]](#).
- [152] J.-W. Wang, X.-J. Bi, Q.-F. Xiang, P.-F. Yin, and Z.-H. Yu, *Exploring triplet-quadruplet fermionic dark matter at the LHC and future colliders*, *Phys. Rev.* **D97** (2018) no. 3, 035021, [arXiv:1711.05622 \[hep-ph\]](#).

- [153] PandaX-II Collaboration, X. Cui et al., *Dark Matter Results From 54-Ton-Day Exposure of PandaX-II Experiment*, *Phys. Rev. Lett.* **119** (2017) no. 18, 181302, [arXiv:1708.06917 \[astro-ph.CO\]](#).
- [154] DARWIN Collaboration, J. Aalbers et al., *DARWIN: towards the ultimate dark matter detector*, *JCAP* **1611** (2016) 017, [arXiv:1606.07001 \[astro-ph.IM\]](#).
- [155] R. J. Hill and M. P. Solon, *WIMP-nucleon scattering with heavy WIMP effective theory*, *Phys. Rev. Lett.* **112** (2014) 211602, [arXiv:1309.4092 \[hep-ph\]](#).
- [156] M. Low and L.-T. Wang, *Neutralino dark matter at 14 TeV and 100 TeV*, *JHEP* **08** (2014) 161, [arXiv:1404.0682 \[hep-ph\]](#).
- [157] J. Kawamura and Y. Omura, *Study of dark matter physics in non-universal gaugino mass scenario*, *JHEP* **08** (2017) 072, [arXiv:1703.10379 \[hep-ph\]](#).
- [158] R. Krall and M. Reece, *Last Electroweak WIMP Standing: Pseudo-Dirac Higgsino Status and Compact Stars as Future Probes*, *Chin. Phys.* **C42** (2018) no. 4, 043105, [arXiv:1705.04843 \[hep-ph\]](#).
- [159] C. Cheung, L. J. Hall, D. Pinner, and J. T. Ruderman, *Prospects and Blind Spots for Neutralino Dark Matter*, *JHEP* **05** (2013) 100, [arXiv:1211.4873 \[hep-ph\]](#).
- [160] P. Huang and C. E. M. Wagner, *Blind Spots for neutralino Dark Matter in the MSSM with an intermediate m_A* , *Phys. Rev.* **D90** (2014) no. 1, 015018, [arXiv:1404.0392 \[hep-ph\]](#).
- [161] T. Han, F. Kling, S. Su, and Y. Wu, *Unblinding the dark matter blind spots*, *JHEP* **02** (2017) 057, [arXiv:1612.02387 \[hep-ph\]](#).
- [162] R. Mahbubani and L. Senatore, *The Minimal model for dark matter and unification*, *Phys. Rev.* **D73** (2006) 043510, [arXiv:hep-ph/0510064 \[hep-ph\]](#).
- [163] T. Cohen, J. Kearney, A. Pierce, and D. Tucker-Smith, *Singlet-Doublet Dark Matter*, *Phys. Rev.* **D85** (2012) 075003, [arXiv:1109.2604 \[hep-ph\]](#).
- [164] A. Dedes and D. Karamitros, *Doublet-Triplet Fermionic Dark Matter*, *Phys. Rev.* **D89** (2014) no. 11, 115002, [arXiv:1403.7744 \[hep-ph\]](#).
- [165] A. Basirnia, S. Macaluso, and D. Shih, *Dark Matter and the Higgs in Natural SUSY*, *JHEP* **03** (2017) 073, [arXiv:1605.08442 \[hep-ph\]](#).
- [166] J. Elias-Miró, C. Grojean, R. S. Gupta, and D. Marzocca, *Scaling and tuning of EW and Higgs observables*, *JHEP* **05** (2014) 019, [arXiv:1312.2928 \[hep-ph\]](#).
- [167] K. Harigaya, K. Ichikawa, A. Kundu, S. Matsumoto, and S. Shirai, *Indirect Probe of Electroweak-Interacting Particles at Future Lepton Colliders*, *JHEP* **09** (2015) 105, [arXiv:1504.03402 \[hep-ph\]](#).

- [168] J. D. Wells and Z. Zhang, *Status and prospects of precision analyses with $e^+e^- \rightarrow W^+W^-$* , *Phys. Rev.* **D93** (2016) no. 3, 034001, [arXiv:1507.01594 \[hep-ph\]](#). [*Phys. Rev.*D93,034001(2016)].
- [169] M. Drees, K. Hagiwara, and A. Yamada, *Process independent radiative corrections in the minimal supersymmetric standard model*, *Phys. Rev.* **D45** (1992) 1725–1743.
- [170] S. P. Martin, K. Tobe, and J. D. Wells, *Virtual effects of light gauginos and higgsinos: A Precision electroweak analysis of split supersymmetry*, *Phys. Rev.* **D71** (2005) 073014, [arXiv:hep-ph/0412424 \[hep-ph\]](#).
- [171] A. Joglekar, P. Schwaller, and C. E. M. Wagner, *Dark Matter and Enhanced Higgs to Di-photon Rate from Vector-like Leptons*, *JHEP* **12** (2012) 064, [arXiv:1207.4235 \[hep-ph\]](#).
- [172] N. Arkani-Hamed, K. Blum, R. T. D’Agnolo, and J. Fan, *2:1 for Naturalness at the LHC?*, *JHEP* **01** (2013) 149, [arXiv:1207.4482 \[hep-ph\]](#).
- [173] C. Englert and M. McCullough, *Modified Higgs Sectors and NLO Associated Production*, *JHEP* **07** (2013) 168, [arXiv:1303.1526 \[hep-ph\]](#).
- [174] R. K. Barman, G. Belanger, B. Bhattacharjee, R. Godbole, G. Mendiratta, and D. Sengupta, *Invisible decay of the Higgs boson in the context of a thermal and nonthermal relic in MSSM*, *Phys. Rev.* **D95** (2017) no. 9, 095018, [arXiv:1703.03838 \[hep-ph\]](#).
- [175] LUX, LZ Collaboration, M. Szydagis, *The Present and Future of Searching for Dark Matter with LUX and LZ*, *PoS ICHEP2016* (2016) 220, [arXiv:1611.05525 \[astro-ph.CO\]](#).
- [176] XENON Collaboration, E. Aprile et al., *Physics reach of the XENONIT dark matter experiment*, *JCAP* **1604** (2016) no. 04, 027, [arXiv:1512.07501 \[physics.ins-det\]](#).
- [177] A. De Simone, G. F. Giudice, and A. Strumia, *Benchmarks for Dark Matter Searches at the LHC*, *JHEP* **06** (2014) 081, [arXiv:1402.6287 \[hep-ph\]](#).
- [178] A. Beniwal, F. Rajec, C. Savage, P. Scott, C. Weniger, M. White, and A. G. Williams, *Combined analysis of effective Higgs portal dark matter models*, *Phys. Rev.* **D93** (2016) no. 11, 115016, [arXiv:1512.06458 \[hep-ph\]](#).
- [179] XENON Collaboration, E. Aprile et al., *Dark Matter Search Results from a One Tonne×Year Exposure of XENONIT*, [arXiv:1805.12562 \[astro-ph.CO\]](#).
- [180] J. Billard, L. Strigari, and E. Figueroa-Feliciano, *Implication of neutrino backgrounds on the reach of next generation dark matter direct detection experiments*, *Phys. Rev.* **D89** (2014) no. 2, 023524, [arXiv:1307.5458 \[hep-ph\]](#).
- [181] PANDA-X Collaboration, H. Zhang et al., *Dark matter direct search sensitivity of the PandaX-4T experiment*, [arXiv:1806.02229 \[physics.ins-det\]](#).

- [182] LZ Collaboration, D. S. Akerib et al., *LUX-ZEPLIN (LZ) Conceptual Design Report*, [arXiv:1509.02910](https://arxiv.org/abs/1509.02910) [physics.ins-det].
- [183] J. Liu, X. Chen, and X. Ji, *Current status of direct dark matter detection experiments*, *Nature Phys.* **13** (2017) no. 3, 212–216, [arXiv:1709.00688](https://arxiv.org/abs/1709.00688) [astro-ph.CO].
- [184] CMS Collaboration, C. Collaboration, *Search for invisible decays of the Higgs boson produced through vector boson fusion at $\sqrt{s} = 13$ TeV*, .
- [185] *Projections for measurements of Higgs boson signal strengths and coupling parameters with the ATLAS detector at a HL-LHC*, ATL-PHYS-PUB-2014-016, CERN, Geneva, Oct, 2014. <http://cds.cern.ch/record/1956710>.
- [186] C. Bernaciak, T. Plehn, P. Schichtel, and J. Tattersall, *Spying an invisible Higgs boson*, *Phys. Rev.* **D91** (2015) 035024, [arXiv:1411.7699](https://arxiv.org/abs/1411.7699) [hep-ph].
- [187] D. Curtin, R. Essig, S. Gori, and J. Shelton, *Illuminating Dark Photons with High-Energy Colliders*, *JHEP* **02** (2015) 157, [arXiv:1412.0018](https://arxiv.org/abs/1412.0018) [hep-ph].
- [188] M. Karliner, M. Low, J. L. Rosner, and L.-T. Wang, *Radiative return capabilities of a high-energy, high-luminosity e^+e^- collider*, *Phys. Rev.* **D92** (2015) no. 3, 035010, [arXiv:1503.07209](https://arxiv.org/abs/1503.07209) [hep-ph].
- [189] ILC Collaboration, G. Aarons et al., *International Linear Collider Reference Design Report Volume 2: Physics at the ILC*, [arXiv:0709.1893](https://arxiv.org/abs/0709.1893) [hep-ph].
- [190] L.-B. Jia, *Study of WIMP annihilations into a pair of on-shell scalar mediators*, *Phys. Rev.* **D94** (2016) no. 9, 095028, [arXiv:1607.00737](https://arxiv.org/abs/1607.00737) [hep-ph].
- [191] L3 Collaboration, M. Acciarri et al., *Missing mass spectra in hadronic events from e^+e^- collisions at $s^{1/2} = 161\text{-GeV} - 172\text{-GeV}$ and limits on invisible Higgs decay*, *Phys. Lett.* **B418** (1998) 389–398.
- [192] DELPHI Collaboration, P. Abreu et al., *A Search for invisible Higgs bosons produced in e^+e^- interactions at LEP-2 energies*, *Phys. Lett.* **B459** (1999) 367–381.
- [193] OPAL, DELPHI, LEP Higgs Working for Higgs boson searches, L3 CERN, ALEPH Collaboration, *Searches for invisible Higgs bosons: Preliminary combined results using LEP data collected at energies up to 209-GeV, in Lepton and photon interactions at high energies. Proceedings, 20th International Symposium, LP 2001, Rome, Italy, July 23-28, 2001*. 2001. [arXiv:hep-ex/0107032](https://arxiv.org/abs/hep-ex/0107032) [hep-ex]. https://inspirehep.net/record/559835/files/arXiv:hep-ex_0107032.pdf.
- [194] B. Batell, N. Lange, D. McKeen, M. Pospelov, and A. Ritz, *Muon anomalous magnetic moment through the leptonic Higgs portal*, *Phys. Rev.* **D95** (2017) no. 7, 075003, [arXiv:1606.04943](https://arxiv.org/abs/1606.04943) [hep-ph].
- [195] T. Liu and C. T. Potter, *Exotic Higgs Decay $h \rightarrow a_1 a_1$ at the International Linear Collider: a Snowmass White Paper*, in *Proceedings, 2013 Community Summer*

- 1 *Study on the Future of U.S. Particle Physics: Snowmass on the Mississippi*
2 (CSSS2013): Minneapolis, MN, USA, July 29-August 6, 2013. 2013.
3 [arXiv:1309.0021](https://arxiv.org/abs/1309.0021) [hep-ph].
4 [https://inspirehep.net/record/1252062/files/arXiv:](https://inspirehep.net/record/1252062/files/arXiv:1309.0021.pdf)
5 [1309.0021.pdf](https://inspirehep.net/record/1252062/files/arXiv:1309.0021.pdf).
- 6 [196] J. Kile, A. Kobach, and A. Soni, *Lepton-Flavored Dark Matter*, *Phys. Lett.* **B744**
7 (2015) 330–338, [arXiv:1411.1407](https://arxiv.org/abs/1411.1407) [hep-ph].
- 8 [197] J. Huang, T. Liu, L.-T. Wang, and F. Yu, *Supersymmetric Exotic Decays of the 125*
9 *GeV Higgs Boson*, *Phys. Rev. Lett.* **112** (2014) no. 22, 221803,
10 [arXiv:1309.6633](https://arxiv.org/abs/1309.6633) [hep-ph].
- 11 [198] E. Gabrielli, B. Mele, M. Raidal, and E. Venturini, *FCNC decays of standard*
12 *model fermions into a dark photon*, *Phys. Rev.* **D94** (2016) no. 11, 115013,
13 [arXiv:1607.05928](https://arxiv.org/abs/1607.05928) [hep-ph].
- 14 [199] Q.-H. Cao, Y. Li, B. Yan, Y. Zhang, and Z. Zhang, *Probing dark particles*
15 *indirectly at the CEPC*, *Nucl. Phys.* **B909** (2016) 197–217,
16 [arXiv:1604.07536](https://arxiv.org/abs/1604.07536) [hep-ph].
- 17 [200] P. Agrawal, S. Blanchet, Z. Chacko, and C. Kilic, *Flavored Dark Matter, and Its*
18 *Implications for Direct Detection and Colliders*, *Phys. Rev.* **D86** (2012) 055002,
19 [arXiv:1109.3516](https://arxiv.org/abs/1109.3516) [hep-ph].
- 20 [201] P. Agrawal, Z. Chacko, E. C. F. S. Fortes, and C. Kilic, *Skew-Flavored Dark*
21 *Matter*, *Phys. Rev.* **D93** (2016) no. 10, 103510, [arXiv:1511.06293](https://arxiv.org/abs/1511.06293)
22 [hep-ph].
- 23 [202] A. Birkedal, K. Matchev, and M. Perelstein, *Dark matter at colliders: A Model*
24 *independent approach*, *Phys. Rev.* **D70** (2004) 077701,
25 [arXiv:hep-ph/0403004](https://arxiv.org/abs/hep-ph/0403004) [hep-ph].
- 26 [203] Y. J. Chae and M. Perelstein, *Dark Matter Search at a Linear Collider: Effective*
27 *Operator Approach*, *JHEP* **05** (2013) 138, [arXiv:1211.4008](https://arxiv.org/abs/1211.4008) [hep-ph].
- 28 [204] H. Dreiner, M. Huck, M. Krämer, D. Schmeier, and J. Tattersall, *Illuminating Dark*
29 *Matter at the ILC*, *Phys. Rev.* **D87** (2013) no. 7, 075015, [arXiv:1211.2254](https://arxiv.org/abs/1211.2254)
30 [hep-ph].
- 31 [205] Z.-H. Yu, Q.-S. Yan, and P.-F. Yin, *Detecting interactions between dark matter*
32 *and photons at high energy e^+e^- colliders*, *Phys. Rev.* **D88** (2013) no. 7, 075015,
33 [arXiv:1307.5740](https://arxiv.org/abs/1307.5740) [hep-ph].
- 34 [206] Z.-H. Yu, X.-J. Bi, Q.-S. Yan, and P.-F. Yin, *Dark matter searches in the mono-Z*
35 *channel at high energy e^+e^- colliders*, *Phys. Rev.* **D90** (2014) no. 5, 055010,
36 [arXiv:1404.6990](https://arxiv.org/abs/1404.6990) [hep-ph].
- 37 [207] Y. Gao and M. Jin, *Z-pole test of effective dark matter diboson interactions at the*
38 *CEPC*, [arXiv:1712.02140](https://arxiv.org/abs/1712.02140) [hep-ph].
- 39 [208] SuperCDMS Collaboration, R. Agnese et al., *Search for Low-Mass Weakly*
40 *Interacting Massive Particles with SuperCDMS*, *Phys. Rev. Lett.* **112** (2014)
41 no. 24, 241302, [arXiv:1402.7137](https://arxiv.org/abs/1402.7137) [hep-ex].

- 1 [209] CDEX Collaboration, H. Jiang et al., *Limits on Light Weakly Interacting Massive*
2 *Particles from the First 102.8 kg \times day Data of the CDEX-10 Experiment*, *Phys.*
3 *Rev. Lett.* **120** (2018) no. 24, 241301, [arXiv:1802.09016 \[hep-ex\]](#).
- 4 [210] SuperCDMS Collaboration, R. Agnese et al., *New Results from the Search for*
5 *Low-Mass Weakly Interacting Massive Particles with the CDMS Low Ionization*
6 *Threshold Experiment*, *Phys. Rev. Lett.* **116** (2016) no. 7, 071301,
7 [arXiv:1509.02448 \[astro-ph.CO\]](#).
- 8 [211] Fermi-LAT Collaboration, M. Ackermann et al., *Updated search for spectral lines*
9 *from Galactic dark matter interactions with pass 8 data from the Fermi Large Area*
10 *Telescope*, *Phys. Rev.* **D91** (2015) no. 12, 122002, [arXiv:1506.00013](#)
11 [\[astro-ph.HE\]](#).
- 12 [212] M. T. Frandsen, U. Haisch, F. Kahlhoefer, P. Mertsch, and K. Schmidt-Hoberg,
13 *Loop-induced dark matter direct detection signals from gamma-ray lines*, *JCAP*
14 **1210** (2012) 033, [arXiv:1207.3971 \[hep-ph\]](#).
- 15 [213] SNO Collaboration, Q. R. Ahmad et al., *Direct evidence for neutrino flavor*
16 *transformation from neutral current interactions in the Sudbury Neutrino*
17 *Observatory*, *Phys. Rev. Lett.* **89** (2002) 011301, [arXiv:nucl-ex/0204008](#)
18 [\[nucl-ex\]](#).
- 19 [214] Super-Kamiokande Collaboration, Y. Fukuda et al., *Evidence for oscillation of*
20 *atmospheric neutrinos*, *Phys. Rev. Lett.* **81** (1998) 1562–1567,
21 [arXiv:hep-ex/9807003 \[hep-ex\]](#).
- 22 [215] *NuFIT 3.2 (2018)*, [HTTP://WWW.NU-FIT.ORG/](http://www.nu-fit.org/).
- 23 [216] I. Esteban, M. C. Gonzalez-Garcia, M. Maltoni, I. Martinez-Soler, and T. Schwetz,
24 *Updated fit to three neutrino mixing: exploring the accelerator-reactor*
25 *complementarity*, *JHEP* **01** (2017) 087, [arXiv:1611.01514 \[hep-ph\]](#).
- 26 [217] M. Lattanzi and M. Gerbino, *Status of neutrino properties and future prospects -*
27 *Cosmological and astrophysical constraints*, *Front.in Phys.* **5** (2018) 70,
28 [arXiv:1712.07109 \[astro-ph.CO\]](#).
- 29 [218] E. Majorana, *Teoria simmetrica dell'electron e del positrone*, *Nuovo Cim.* **14**
30 (1937) 171–184.
- 31 [219] Y. Cai, T. Han, T. Li, and R. Ruiz, *Lepton-Number Violation: Seesaw Models and*
32 *Their Collider Tests*, [arXiv:1711.02180 \[hep-ph\]](#).
- 33 [220] K. N. Abazajian et al., *Light Sterile Neutrinos: A White Paper*,
34 [arXiv:1204.5379 \[hep-ph\]](#).
- 35 [221] M. Drewes, *The Phenomenology of Right Handed Neutrinos*, *Int. J. Mod. Phys.*
36 **E22** (2013) 1330019, [arXiv:1303.6912 \[hep-ph\]](#).
- 37 [222] E. Ma, *Pathways to naturally small neutrino masses*, *Phys. Rev. Lett.* **81** (1998)
38 1171–1174, [arXiv:hep-ph/9805219 \[hep-ph\]](#).
- 39 [223] S. L. Glashow, *The Future of Elementary Particle Physics*, *NATO Sci. Ser. B* **61**
40 (1980) 687.

- [224] M. Gell-Mann, P. Ramond, and R. Slansky, *Complex Spinors and Unified Theories*, Conf. Proc. **C790927** (1979) 315–321, [arXiv:1306.4669 \[hep-th\]](#).
- [225] T. Yanagida, *Horizontal Symmetry and Masses of Neutrinos*, *Prog. Theor. Phys.* **64** (1980) 1103.
- [226] J. Schechter and J. W. F. Valle, *Neutrino Masses in $SU(2) \times U(1)$ Theories*, *Phys. Rev.* **D22** (1980) 2227.
- [227] M. Magg and C. Wetterich, *Neutrino Mass Problem and Gauge Hierarchy*, *Phys. Lett.* **94B** (1980) 61–64.
- [228] T. P. Cheng and L.-F. Li, *Neutrino Masses, Mixings and Oscillations in $SU(2) \times U(1)$ Models of Electroweak Interactions*, *Phys. Rev.* **D22** (1980) 2860.
- [229] G. Lazarides, Q. Shafi, and C. Wetterich, *Proton Lifetime and Fermion Masses in an $SO(10)$ Model*, *Nucl. Phys.* **B181** (1981) 287–300.
- [230] R. N. Mohapatra and G. Senjanovic, *Neutrino Masses and Mixings in Gauge Models with Spontaneous Parity Violation*, *Phys. Rev.* **D23** (1981) 165.
- [231] R. Foot, H. Lew, X. G. He, and G. C. Joshi, *Seesaw Neutrino Masses Induced by a Triplet of Leptons*, *Z. Phys.* **C44** (1989) 441.
- [232] C. D. Froggatt and H. B. Nielsen, *Hierarchy of Quark Masses, Cabibbo Angles and CP Violation*, *Nucl. Phys.* **B147** (1979) 277–298.
- [233] A. Zee, *A Theory of Lepton Number Violation, Neutrino Majorana Mass, and Oscillation*, *Phys. Lett.* **93B** (1980) 389. [Erratum: *Phys. Lett.* 95B,461(1980)].
- [234] E. Witten, *Neutrino Masses in the Minimal $O(10)$ Theory*, *Phys. Lett.* **91B** (1980) 81–84.
- [235] A. Zee, *Quantum Numbers of Majorana Neutrino Masses*, *Nucl. Phys.* **B264** (1986) 99–110.
- [236] K. S. Babu, *Model of 'Calculable' Majorana Neutrino Masses*, *Phys. Lett.* **B203** (1988) 132–136.
- [237] E. Ma, *Verifiable radiative seesaw mechanism of neutrino mass and dark matter*, *Phys. Rev.* **D73** (2006) 077301, [arXiv:hep-ph/0601225 \[hep-ph\]](#).
- [238] M. Shaposhnikov, *A Possible symmetry of the nuMSM*, *Nucl. Phys.* **B763** (2007) 49–59, [arXiv:hep-ph/0605047 \[hep-ph\]](#).
- [239] *Right-Handed Neutrinos at CERN LHC and the Mechanism of Neutrino Mass Generation*, *Phys. Rev.* **D76** (2007) 073005, [arXiv:0705.3221 \[hep-ph\]](#).
- [240] K. Moffat, S. Pascoli, and C. Weiland, *Equivalence between massless neutrinos and lepton number conservation in fermionic singlet extensions of the Standard Model*, [arXiv:1712.07611 \[hep-ph\]](#).
- [241] R. N. Mohapatra, *Mechanism for Understanding Small Neutrino Mass in Superstring Theories*, *Phys. Rev. Lett.* **56** (1986) 561–563.

- [242] R. N. Mohapatra and J. W. F. Valle, *Neutrino Mass and Baryon Number Nonconservation in Superstring Models*, *Phys. Rev.* **D34** (1986) 1642.
- [243] J. Bernabeu, A. Santamaria, J. Vidal, A. Mendez, and J. W. F. Valle, *Lepton Flavor Nonconservation at High-Energies in a Superstring Inspired Standard Model*, *Phys. Lett.* **B187** (1987) 303–308.
- [244] E. K. Akhmedov, M. Lindner, E. Schnapka, and J. W. F. Valle, *Left-right symmetry breaking in NJL approach*, *Phys. Lett.* **B368** (1996) 270–280, [arXiv:hep-ph/9507275](#) [hep-ph].
- [245] E. K. Akhmedov, M. Lindner, E. Schnapka, and J. W. F. Valle, *Dynamical left-right symmetry breaking*, *Phys. Rev.* **D53** (1996) 2752–2780, [arXiv:hep-ph/9509255](#) [hep-ph].
- [246] T. Asaka, S. Blanchet, and M. Shaposhnikov, *The nuMSM, dark matter and neutrino masses*, *Phys. Lett.* **B631** (2005) 151–156, [arXiv:hep-ph/0503065](#) [hep-ph].
- [247] T. Asaka and M. Shaposhnikov, *The nuMSM, dark matter and baryon asymmetry of the universe*, *Phys. Lett.* **B620** (2005) 17–26, [arXiv:hep-ph/0505013](#) [hep-ph].
- [248] V. V. Khoze and G. Ro, *Leptogenesis and Neutrino Oscillations in the Classically Conformal Standard Model with the Higgs Portal*, *JHEP* **10** (2013) 075, [arXiv:1307.3764](#) [hep-ph].
- [249] B. Bajc and G. Senjanovic, *Seesaw at LHC*, *JHEP* **08** (2007) 014, [arXiv:hep-ph/0612029](#) [hep-ph].
- [250] B. Bajc, M. Nemevsek, and G. Senjanovic, *Probing seesaw at LHC*, *Phys. Rev.* **D76** (2007) 055011, [arXiv:hep-ph/0703080](#) [hep-ph].
- [251] F. del Aguila, J. A. Aguilar-Saavedra, A. Martinez de la Ossa, and D. Meloni, *Flavor and polarisation in heavy neutrino production at e^+e^- colliders*, *Phys. Lett.* **B613** (2005) 170–180, [arXiv:hep-ph/0502189](#) [hep-ph].
- [252] T. Saito, M. Asano, K. Fujii, N. Haba, S. Matsumoto, T. Nabeshima, Y. Takubo, H. Yamamoto, and K. Yoshioka, *Extra dimensions and Seesaw Neutrinos at the International Linear Collider*, *Phys. Rev.* **D82** (2010) 093004, [arXiv:1008.2257](#) [hep-ph].
- [253] A. Das and N. Okada, *Inverse seesaw neutrino signatures at the LHC and ILC*, *Phys. Rev.* **D88** (2013) 113001, [arXiv:1207.3734](#) [hep-ph].
- [254] S. Banerjee, P. S. B. Dev, A. Ibarra, T. Mandal, and M. Mitra, *Prospects of Heavy Neutrino Searches at Future Lepton Colliders*, *Phys. Rev.* **D92** (2015) 075002, [arXiv:1503.05491](#) [hep-ph].
- [255] W. Liao and X.-H. Wu, *Signature of heavy sterile neutrinos at CEPC*, *Phys. Rev.* **D97** (2018) no. 5, 055005, [arXiv:1710.09266](#) [hep-ph].
- [256] G. Anamiati, M. Hirsch, and E. Nardi, *Quasi-Dirac neutrinos at the LHC*, *JHEP* **10** (2016) 010, [arXiv:1607.05641](#) [hep-ph].

- [257] S. Antusch, E. Cazzato, and O. Fischer, *Heavy neutrino-antineutrino oscillations at colliders*, [arXiv:1709.03797 \[hep-ph\]](#).
- [258] S. Antusch, E. Cazzato, M. Drewes, O. Fischer, B. Garbrecht, D. Gueter, and J. Klaric, *Probing Leptogenesis at Future Colliders*, [arXiv:1710.03744 \[hep-ph\]](#).
- [259] E. J. Chun, K. Y. Lee, and S. C. Park, *Testing Higgs triplet model and neutrino mass patterns*, *Phys. Lett.* **B566** (2003) 142–151, [arXiv:hep-ph/0304069 \[hep-ph\]](#).
- [260] J. Garayoa and T. Schwetz, *Neutrino mass hierarchy and Majorana CP phases within the Higgs triplet model at the LHC*, *JHEP* **03** (2008) 009, [arXiv:0712.1453 \[hep-ph\]](#).
- [261] M. L. Swartz, *Limits on Doubly Charged Higgs Bosons and Lepton Flavor Violation*, *Phys. Rev.* **D40** (1989) 1521.
- [262] P. Fileviez Perez, T. Han, G.-y. Huang, T. Li, and K. Wang, *Neutrino Masses and the CERN LHC: Testing Type II Seesaw*, *Phys. Rev.* **D78** (2008) 015018, [arXiv:0805.3536 \[hep-ph\]](#).
- [263] A. Melfo, M. Nemevsek, F. Nesti, G. Senjanovic, and Y. Zhang, *Type II Seesaw at LHC: The Roadmap*, *Phys. Rev.* **D85** (2012) 055018, [arXiv:1108.4416 \[hep-ph\]](#).
- [264] ATLAS Collaboration, M. Aaboud et al., *Search for doubly charged Higgs boson production in multi-lepton final states with the ATLAS detector using proton-proton collisions at $\sqrt{s} = 13$ TeV*, *Eur. Phys. J.* **C78** (2018) no. 3, 199, [arXiv:1710.09748 \[hep-ex\]](#).
- [265] M. Mitra, S. Niyogi, and M. Spannowsky, *Type-II Seesaw Model and Multilepton Signatures at Hadron Colliders*, *Phys. Rev.* **D95** (2017) no. 3, 035042, [arXiv:1611.09594 \[hep-ph\]](#).
- [266] S. Kanemura, M. Kikuchi, K. Yagyu, and H. Yokoya, *Bounds on the mass of doubly-charged Higgs bosons in the same-sign diboson decay scenario*, *Phys. Rev.* **D90** (2014) no. 11, 115018, [arXiv:1407.6547 \[hep-ph\]](#).
- [267] M. Aoki, S. Kanemura, and K. Yagyu, *Testing the Higgs triplet model with the mass difference at the LHC*, *Phys. Rev.* **D85** (2012) 055007, [arXiv:1110.4625 \[hep-ph\]](#).
- [268] Z.-L. Han, R. Ding, and Y. Liao, *LHC phenomenology of the type II seesaw mechanism: Observability of neutral scalars in the nondegenerate case*, *Phys. Rev.* **D92** (2015) no. 3, 033014, [arXiv:1506.08996 \[hep-ph\]](#).
- [269] P. Agrawal, M. Mitra, S. Niyogi, S. Shil, and M. Spannowsky, *Probing the Type-II Seesaw Mechanism through the Production of Higgs Bosons at a Lepton Collider*, [arXiv:1803.00677 \[hep-ph\]](#).
- [270] T. G. Rizzo, *Doubly Charged Higgs Bosons and Lepton Number Violating Processes*, *Phys. Rev.* **D25** (1982) 1355–1364. [Addendum: *Phys. Rev.* **D27**, 657 (1983)].

- [271] M. Lusignoli and S. Petrarca, *EXOTIC HIGGS PRODUCTION AT $E^+ E^-$ COLLIDERS*, *Phys. Lett.* **B226** (1989) 397–400.
- [272] J. F. Gunion, J. Grifols, A. Mendez, B. Kayser, and F. I. Olness, *Higgs Bosons in Left-Right Symmetric Models*, *Phys. Rev.* **D40** (1989) 1546.
- [273] S. Atag and K. O. Ozansoy, *Realistic constraints on the doubly charged bilepton couplings from Bhabha scattering with LEP data*, *Phys. Rev.* **D68** (2003) 093008, [arXiv:hep-ph/0310046](#) [hep-ph].
- [274] V. D. Barger, J. F. Beacom, K.-m. Cheung, and T. Han, *Production of weak bosons and Higgs bosons in $e^- e^-$ collisions*, *Phys. Rev.* **D50** (1994) 6704–6712, [arXiv:hep-ph/9404335](#) [hep-ph].
- [275] W. Rodejohann and H. Zhang, *Higgs triplets at like-sign linear colliders and neutrino mixing*, *Phys. Rev.* **D83** (2011) 073005, [arXiv:1011.3606](#) [hep-ph].
- [276] J. C. Pati and A. Salam, *Lepton Number as the Fourth Color*, *Phys. Rev.* **D10** (1974) 275–289. [Erratum: *Phys. Rev.* **D11**, 703(1975)].
- [277] R. N. Mohapatra and J. C. Pati, *Left-Right Gauge Symmetry and an Isoconjugate Model of CP Violation*, *Phys. Rev.* **D11** (1975) 566–571.
- [278] G. Senjanovic and R. N. Mohapatra, *Exact Left-Right Symmetry and Spontaneous Violation of Parity*, *Phys. Rev.* **D12** (1975) 1502.
- [279] G. Senjanovic, *Spontaneous Breakdown of Parity in a Class of Gauge Theories*, *Nucl. Phys.* **B153** (1979) 334–364.
- [280] A. Maiezza, M. Nemevsek, and F. Nesti, *Lepton Number Violation in Higgs Decay at LHC*, *Phys. Rev. Lett.* **115** (2015) 081802, [arXiv:1503.06834](#) [hep-ph].
- [281] M. Nemevsek, F. Nesti, and J. C. Vasquez, *Majorana Higgses at colliders*, *JHEP* **04** (2017) 114, [arXiv:1612.06840](#) [hep-ph].
- [282] F. del Aguila and J. A. Aguilar-Saavedra, *Distinguishing seesaw models at LHC with multi-lepton signals*, *Nucl. Phys.* **B813** (2009) 22–90, [arXiv:0808.2468](#) [hep-ph].
- [283] A. Abada, V. De Romeri, S. Monteil, J. Orloff, and A. M. Teixeira, *Indirect searches for sterile neutrinos at a high-luminosity Z-factory*, *JHEP* **04** (2015) 051, [arXiv:1412.6322](#) [hep-ph].
- [284] S. Antusch, E. Cazzato, and O. Fischer, *Sterile neutrino searches at future $e^- e^+$, pp , and $e^- p$ colliders*, *Int. J. Mod. Phys.* **A32** (2017) no. 14, 1750078, [arXiv:1612.02728](#) [hep-ph].
- [285] S. Banerjee, B. Bhattacharjee, M. Mitra, and M. Spannowsky, *The Lepton Flavour Violating Higgs Decays at the HL-LHC and the ILC*, *JHEP* **07** (2016) 059, [arXiv:1603.05952](#) [hep-ph].

- [286] E. Arganda, M. J. Herrero, X. Marcano, and C. Weiland, *Imprints of massive inverse seesaw model neutrinos in lepton flavor violating Higgs boson decays*, *Phys. Rev.* **D91** (2015) no. 1, 015001, [arXiv:1405.4300 \[hep-ph\]](#).
- [287] *Charged lepton flavor violating Higgs decays at the CEPC*, [arXiv:1711.07243 \[hep-ph\]](#).
- [288] Particle Data Group Collaboration, C. Patrignani et al., *Review of Particle Physics*, *Chin. Phys.* **C40** (2016) no. 10, 100001.
- [289] S. Antusch and O. Fischer, *Non-unitarity of the leptonic mixing matrix: Present bounds and future sensitivities*, *JHEP* **10** (2014) 094, [arXiv:1407.6607 \[hep-ph\]](#).
- [290] J.-h. Park, *Lepton non-universality at LEP and charged Higgs*, *JHEP* **10** (2006) 077, [arXiv:hep-ph/0607280 \[hep-ph\]](#).
- [291] P. S. B. Dev, R. N. Mohapatra, and Y. Zhang, *Lepton Flavor Violation Induced by a Neutral Scalar at Future Lepton Colliders*, *Phys. Rev. Lett.* **120** (2018) no. 22, 221804, [arXiv:1711.08430 \[hep-ph\]](#).
- [292] S. Antusch, E. Cazzato, and O. Fischer, *Higgs production from sterile neutrinos at future lepton colliders*, *JHEP* **04** (2016) 189, [arXiv:1512.06035 \[hep-ph\]](#).
- [293] S. Antusch, E. Cazzato, and O. Fischer, *Higgs production through sterile neutrinos*, *Int. J. Mod. Phys.* **A31** (2016) no. 33, 1644007. [,93(2017)].
- [294] S. Antusch and O. Fischer, *Testing sterile neutrino extensions of the Standard Model at future lepton colliders*, *JHEP* **05** (2015) 053, [arXiv:1502.05915 \[hep-ph\]](#).
- [295] *Combining experimental and cosmological constraints on heavy neutrinos*, *Nucl. Phys.* **B921** (2017) 250–315, [arXiv:1502.00477 \[hep-ph\]](#).
- [296] E. Accomando, L. Delle Rose, S. Moretti, E. Olaiya, and C. H. Shepherd-Themistocleous, *Extra Higgs boson and Z^2 as portals to signatures of heavy neutrinos at the LHC*, *JHEP* **02** (2018) 109, [arXiv:1708.03650 \[hep-ph\]](#).
- [297] F. F. Deppisch, W. Liu, and M. Mitra, *Long-lived Heavy Neutrinos from Higgs Decays*, [arXiv:1804.04075 \[hep-ph\]](#).
- [298] A. G. Akeroyd and S. Moretti, *Enhancement of H to $\gamma\gamma$ from doubly charged scalars in the Higgs Triplet Model*, *Phys. Rev.* **D86** (2012) 035015, [arXiv:1206.0535 \[hep-ph\]](#).
- [299] P. S. Bhupal Dev, D. K. Ghosh, N. Okada, and I. Saha, *125 GeV Higgs Boson and the Type-II Seesaw Model*, *JHEP* **03** (2013) 150, [arXiv:1301.3453 \[hep-ph\]](#). [Erratum: JHEP05,049(2013)].
- [300] D. Das and A. Santamaria, *Updated scalar sector constraints in the Higgs triplet model*, *Phys. Rev.* **D94** (2016) no. 1, 015015, [arXiv:1604.08099 \[hep-ph\]](#).

- [301] L. Basso, O. Fischer, and J. J. van der Bij, *A singlet-triplet extension for the Higgs search at LEP and LHC*, *EPL* **101** (2013) no. 5, 51004, [arXiv:1212.5560 \[hep-ph\]](#).
- [302] A. Maiezza, M. Nemevsek, and F. Nesti, *Perturbativity and mass scales in the minimal left-right symmetric model*, *Phys. Rev.* **D94** (2016) no. 3, 035008, [arXiv:1603.00360 \[hep-ph\]](#).
- [303] *The triple Higgs coupling: A new probe of low-scale seesaw models*, *JHEP* **04** (2017) 038, [arXiv:1612.06403 \[hep-ph\]](#).
- [304] I. Gogoladze, N. Okada, and Q. Shafi, *Higgs Boson Mass Bounds in the Standard Model with Type III and Type I Seesaw*, *Phys. Lett.* **B668** (2008) 121–125, [arXiv:0805.2129 \[hep-ph\]](#).
- [305] B. He, N. Okada, and Q. Shafi, *125 GeV Higgs, type III seesaw and gauge?Higgs unification*, *Phys. Lett.* **B716** (2012) 197–202, [arXiv:1205.4038 \[hep-ph\]](#).
- [306] S. Antusch and O. Fischer, *Testing sterile neutrino extensions of the Standard Model at the Circular Electron Positron Collider*, *Int. J. Mod. Phys.* **A30** (2015) no. 23, 1544004.
- [307] S. Antusch and O. Fischer, *Probing the nonunitarity of the leptonic mixing matrix at the CEPC*, *Int. J. Mod. Phys.* **A31** (2016) no. 33, 1644006, [arXiv:1604.00208 \[hep-ph\]](#). [,83(2017)].
- [308] S. Antusch, E. Cazzato, and O. Fischer, *Displaced vertex searches for sterile neutrinos at future lepton colliders*, *JHEP* **12** (2016) 007, [arXiv:1604.02420 \[hep-ph\]](#).
- [309] A. Abada, C. Biggio, F. Bonnet, M. B. Gavela, and T. Hambye, *Low energy effects of neutrino masses*, *JHEP* **12** (2007) 061, [arXiv:0707.4058 \[hep-ph\]](#).
- [310] R. Ruiz, *Lepton Number Violation at Colliders from Kinematically Inaccessible Gauge Bosons*, *Eur. Phys. J.* **C77** (2017) no. 6, 375, [arXiv:1703.04669 \[hep-ph\]](#).
- [311] S. Antusch, C. Biggio, E. Fernandez-Martinez, M. B. Gavela, and J. Lopez-Pavon, *Unitarity of the Leptonic Mixing Matrix*, *JHEP* **10** (2006) 084, [arXiv:hep-ph/0607020 \[hep-ph\]](#).
- [312] F. del Aguila, J. de Blas, and M. Perez-Victoria, *Effects of new leptons in Electroweak Precision Data*, *Phys. Rev.* **D78** (2008) 013010, [arXiv:0803.4008 \[hep-ph\]](#).
- [313] S. Parke and M. Ross-Lonergan, *Unitarity and the three flavor neutrino mixing matrix*, *Phys. Rev.* **D93** (2016) no. 11, 113009, [arXiv:1508.05095 \[hep-ph\]](#).
- [314] A. Atre, T. Han, S. Pascoli, and B. Zhang, *The Search for Heavy Majorana Neutrinos*, *JHEP* **05** (2009) 030, [arXiv:0901.3589 \[hep-ph\]](#).

- [315] *Global Constraints on a Heavy Neutrino*, *Phys. Rev.* **D93** (2016) no. 3, 033005, [arXiv:1511.00683 \[hep-ph\]](#).
- [316] E. Fernandez-Martinez, J. Hernandez-Garcia, and J. Lopez-Pavon, *Global constraints on heavy neutrino mixing*, *JHEP* **08** (2016) 033, [arXiv:1605.08774 \[hep-ph\]](#).
- [317] F. J. Escrihuela, D. V. Forero, O. G. Miranda, M. Tortola, and J. W. F. Valle, *On the description of nonunitary neutrino mixing*, *Phys. Rev.* **D92** (2015) no. 5, 053009, [arXiv:1503.08879 \[hep-ph\]](#). [Erratum: *Phys. Rev.* **D93**, no. 11, 119905 (2016)].
- [318] J. P. Chou, D. Curtin, and H. J. Lubatti, *New Detectors to Explore the Lifetime Frontier*, *Phys. Lett.* **B767** (2017) 29–36, [arXiv:1606.06298 \[hep-ph\]](#).
- [319] MATHUSLA Collaboration, C. Alpigiani, *Ultra Long-Lived Particles with MATHUSLA*, *PoS EPS-HEP2017* (2017) 772.
- [320] F. Kling and S. Trojanowski, *Heavy Neutral Leptons at FASER*, [arXiv:1801.08947 \[hep-ph\]](#).
- [321] P. S. B. Dev, R. N. Mohapatra, and Y. Zhang, *Long Lived Light Scalars as Probe of Low Scale Seesaw Models*, *Nucl. Phys.* **B923** (2017) 179–221, [arXiv:1703.02471 \[hep-ph\]](#).
- [322] P. Bhupal Dev, R. N. Mohapatra, and Y. Zhang, *Displaced photon signal from a possible light scalar in minimal left-right seesaw model*, *Phys. Rev.* **D95** (2017) no. 11, 115001, [arXiv:1612.09587 \[hep-ph\]](#).
- [323] DELPHI Collaboration, P. Abreu et al., *Searches for heavy neutrinos from Z decays*, *Phys. Lett.* **B274** (1992) 230–238.
- [324] DELPHI Collaboration, P. Abreu et al., *Search for neutral heavy leptons produced in Z decays*, *Z. Phys.* **C74** (1997) 57–71. [Erratum: *Z. Phys.* **C75**, 580 (1997)].
- [325] *Probing leptogenesis with GeV-scale sterile neutrinos at LHCb and Belle II*, *Phys. Rev.* **D90** (2014) no. 12, 125005, [arXiv:1404.7114 \[hep-ph\]](#).
- [326] A. Freitas, *Weakly coupled neutral gauge bosons at future linear colliders*, *Phys. Rev.* **D70** (2004) 015008, [arXiv:hep-ph/0403288 \[hep-ph\]](#).
- [327] S. Iso, N. Okada, and Y. Orikasa, *The minimal B-L model naturally realized at TeV scale*, *Phys. Rev.* **D80** (2009) 115007, [arXiv:0909.0128 \[hep-ph\]](#).
- [328] L. Basso, A. Belyaev, S. Moretti, and G. M. Pruna, *Probing the Z-prime sector of the minimal B-L model at future Linear Colliders in the $e^+ e^- \rightarrow \mu^+ \mu^-$ process*, *JHEP* **10** (2009) 006, [arXiv:0903.4777 \[hep-ph\]](#).
- [329] S. Bertolini, A. Maiezza, and F. Nesti, *Present and Future K and B Meson Mixing Constraints on TeV Scale Left-Right Symmetry*, *Phys. Rev.* **D89** (2014) no. 9, 095028, [arXiv:1403.7112 \[hep-ph\]](#).
- [330] A. Maiezza and M. Nemevsek, *Strong P invariance, neutron electric dipole moment, and minimal left-right parity at LHC*, *Phys. Rev.* **D90** (2014) no. 9, 095002, [arXiv:1407.3678 \[hep-ph\]](#).

- [331] W.-Y. Keung and G. Senjanovic, *Majorana Neutrinos and the Production of the Right-handed Charged Gauge Boson*, *Phys. Rev. Lett.* **50** (1983) 1427.
- [332] M. Nemevsek, F. Nesti, G. Senjanovic, and Y. Zhang, *First Limits on Left-Right Symmetry Scale from LHC Data*, *Phys. Rev.* **D83** (2011) 115014, [arXiv:1103.1627 \[hep-ph\]](#).
- [333] A. Ferrari, J. Collot, M.-L. Andrieux, B. Belhorma, P. de Saintignon, J.-Y. Hostachy, P. Martin, and M. Wielers, *Sensitivity study for new gauge bosons and right-handed Majorana neutrinos in pp collisions at $s = 14\text{-TeV}$* , *Phys. Rev.* **D62** (2000) 013001.
- [334] M. Mitra, R. Ruiz, D. J. Scott, and M. Spannowsky, *Neutrino Jets from High-Mass W_R Gauge Bosons in TeV-Scale Left-Right Symmetric Models*, *Phys. Rev.* **D94** (2016) no. 9, 095016, [arXiv:1607.03504 \[hep-ph\]](#).
- [335] O. Mattelaer, M. Mitra, and R. Ruiz, *Automated Neutrino Jet and Top Jet Predictions at Next-to-Leading-Order with Parton Shower Matching in Effective Left-Right Symmetric Models*, [arXiv:1610.08985 \[hep-ph\]](#).
- [336] G. Cottin, J. C. Helo, and M. Hirsch, *Searches for light sterile neutrinos with multitrack displaced vertices*, *Phys. Rev.* **D97** (2018) no. 5, 055025, [arXiv:1801.02734 \[hep-ph\]](#).
- [337] M. Nemevsek, F. Nesti, and G. Popara, *Keung-Senjanović process at LHC: from LNV to displaced vertices to invisible decays*, [arXiv:1801.05813 \[hep-ph\]](#).
- [338] M. Fukugita and T. Yanagida, *Baryogenesis Without Grand Unification*, *Phys. Lett.* **B174** (1986) 45–47.
- [339] V. A. Kuzmin, V. A. Rubakov, and M. E. Shaposhnikov, *On the Anomalous Electroweak Baryon Number Nonconservation in the Early Universe*, *Phys. Lett.* **B155** (1985) 36.
- [340] L. Canetti, M. Drewes, and M. Shaposhnikov, *Matter and Antimatter in the Universe*, *New J. Phys.* **14** (2012) 095012, [arXiv:1204.4186 \[hep-ph\]](#).
- [341] A. Sakharov, *Violation of CP Invariance, c Asymmetry, and Baryon Asymmetry of the Universe*, *Pisma Zh.Eksp.Teor.Fiz.* **5** (1967) 32–35.
- [342] F. F. Deppisch, J. Harz, and M. Hirsch, *Falsifying High-Scale Leptogenesis at the LHC*, *Phys. Rev. Lett.* **112** (2014) 221601, [arXiv:1312.4447 \[hep-ph\]](#).
- [343] *Falsifying High-Scale Baryogenesis with Neutrinoless Double Beta Decay and Lepton Flavor Violation*, *Phys. Rev.* **D92** (2015) no. 3, 036005, [arXiv:1503.04825 \[hep-ph\]](#).
- [344] E. J. Chun et al., *Probing Leptogenesis*, *Int. J. Mod. Phys.* **A33** (2018) no. 05n06, 1842005, [arXiv:1711.02865 \[hep-ph\]](#).
- [345] A. Pilaftsis and T. E. J. Underwood, *Resonant leptogenesis*, *Nucl. Phys.* **B692** (2004) 303–345, [arXiv:hep-ph/0309342 \[hep-ph\]](#).

- [346] E. K. Akhmedov, V. A. Rubakov, and A. Yu. Smirnov, *Baryogenesis via neutrino oscillations*, *Phys. Rev. Lett.* **81** (1998) 1359–1362, [arXiv:hep-ph/9803255 \[hep-ph\]](#).
- [347] T. Hambye and D. Teresi, *Higgs doublet decay as the origin of the baryon asymmetry*, *Phys. Rev. Lett.* **117** (2016) no. 9, 091801, [arXiv:1606.00017 \[hep-ph\]](#).
- [348] M. Drewes et al., *A White Paper on keV Sterile Neutrino Dark Matter*, *JCAP* **1701** (2017) no. 01, 025, [arXiv:1602.04816 \[hep-ph\]](#).
- [349] *Testable Baryogenesis in Seesaw Models*, *JHEP* **08** (2016) 157, [arXiv:1606.06719 \[hep-ph\]](#).
- [350] M. Drewes, B. Garbrecht, D. Gueter, and J. Klaric, *Testing the low scale seesaw and leptogenesis*, *JHEP* **08** (2017) 018, [arXiv:1609.09069 \[hep-ph\]](#).
- [351] C. O. Dib, C. S. Kim, K. Wang, and J. Zhang, *Distinguishing Dirac/Majorana Sterile Neutrinos at the LHC*, *Phys. Rev.* **D94** (2016) no. 1, 013005, [arXiv:1605.01123 \[hep-ph\]](#).
- [352] L. Canetti, M. Drewes, T. Frossard, and M. Shaposhnikov, *Dark Matter, Baryogenesis and Neutrino Oscillations from Right Handed Neutrinos*, *Phys. Rev.* **D87** (2013) 093006, [arXiv:1208.4607 \[hep-ph\]](#).
- [353] G. C. Branco, P. M. Ferreira, L. Lavoura, M. N. Rebelo, M. Sher, and J. P. Silva, *Theory and phenomenology of two-Higgs-doublet models*, *Phys. Rept.* **516** (2012) 1–102, [arXiv:1106.0034 \[hep-ph\]](#).
- [354] ATLAS Collaboration, M. Aaboud et al., *Search for additional heavy neutral Higgs and gauge bosons in the ditau final state produced in 36 fb² of pp collisions at $\sqrt{s} = 13$ TeV with the ATLAS detector*, *JHEP* **01** (2018) 055, [arXiv:1709.07242 \[hep-ex\]](#).
- [355] CMS Collaboration, C. Collaboration, *Search for additional neutral MSSM Higgs bosons in the di-tau final state in pp collisions at $\sqrt{s} = 13$ TeV*, .
- [356] ATLAS Collaboration, M. Aaboud et al., *Search for heavy resonances decaying into WW in the $e\nu\mu\nu$ final state in pp collisions at $\sqrt{s} = 13$ TeV with the ATLAS detector*, *Eur. Phys. J.* **C78** (2018) no. 1, 24, [arXiv:1710.01123 \[hep-ex\]](#).
- [357] ATLAS Collaboration, M. Aaboud et al., *Search for heavy ZZ resonances in the $\ell^+\ell^-\ell^+\ell^-$ and $\ell^+\ell^-\nu\bar{\nu}$ final states using proton proton collisions at $\sqrt{s} = 13$ TeV with the ATLAS detector*, [arXiv:1712.06386 \[hep-ex\]](#).
- [358] CMS Collaboration, C. Collaboration, *Search for a new scalar resonance decaying to a pair of Z bosons in proton-proton collisions at $\sqrt{s} = 13$ TeV*, .
- [359] ATLAS Collaboration, M. Aaboud et al., *Search for new phenomena in high-mass diphoton final states using 37 fb⁻¹ of proton–proton collisions collected at $\sqrt{s} = 13$ TeV with the ATLAS detector*, *Phys. Lett.* **B775** (2017) 105–125, [arXiv:1707.04147 \[hep-ex\]](#).

- [360] ATLAS Collaboration, M. Aaboud et al., *Search for heavy resonances decaying into a W or Z boson and a Higgs boson in final states with leptons and b -jets in 36 fb^{-1} of $\sqrt{s} = 13\text{ TeV}$ pp collisions with the ATLAS detector*, [arXiv:1712.06518](https://arxiv.org/abs/1712.06518) [hep-ex].
- [361] ATLAS Collaboration, T. A. collaboration, *Search for charged Higgs bosons in the $H^\pm \rightarrow tb$ decay channel in pp collisions at $\sqrt{s} = 13\text{ TeV}$ using the ATLAS detector*, .
- [362] ATLAS Collaboration, T. A. collaboration, *Search for charged Higgs bosons in the τ +jets final state using 14.7 fb^{-1} of pp collision data recorded at $\sqrt{s}=13\text{ TeV}$ with the ATLAS experiment*, .
- [363] *Beyond Standard Model Higgs boson searches at a High-Luminosity LHC with ATLAS*, ATL-PHYS-PUB-2013-016, CERN, Geneva, Oct, 2013. <http://cds.cern.ch/record/1611190>.
- [364] CMS Collaboration, C. Collaboration, *2HDM Neutral Higgs Future Analysis Studies*, .
- [365] M. Carena, I. Low, N. R. Shah, and C. E. M. Wagner, *Impersonating the Standard Model Higgs Boson: Alignment without Decoupling*, *JHEP* **04** (2014) 015, [arXiv:1310.2248](https://arxiv.org/abs/1310.2248) [hep-ph].
- [366] P. S. Bhupal Dev and A. Pilaftsis, *Maximally Symmetric Two Higgs Doublet Model with Natural Standard Model Alignment*, *JHEP* **12** (2014) 024, [arXiv:1408.3405](https://arxiv.org/abs/1408.3405) [hep-ph]. [Erratum: *JHEP*11,147(2015)].
- [367] J. Bernon, J. F. Gunion, H. E. Haber, Y. Jiang, and S. Kraml, *Scrutinizing the alignment limit in two-Higgs-doublet models: $m_h=125\text{ GeV}$* , *Phys. Rev.* **D92** (2015) no. 7, 075004, [arXiv:1507.00933](https://arxiv.org/abs/1507.00933) [hep-ph].
- [368] G. P. Lepage, P. B. Mackenzie, and M. E. Peskin, *Expected Precision of Higgs Boson Partial Widths within the Standard Model*, [arXiv:1404.0319](https://arxiv.org/abs/1404.0319) [hep-ph].
- [369] M. Baak et al., *Working Group Report: Precision Study of Electroweak Interactions*, in *Proceedings, 2013 Community Summer Study on the Future of U.S. Particle Physics: Snowmass on the Mississippi (CSS2013): Minneapolis, MN, USA, July 29-August 6, 2013*. 2013. [arXiv:1310.6708](https://arxiv.org/abs/1310.6708) [hep-ph]. <http://www.slac.stanford.edu/econf/C1307292/docs/EnergyFrontier/Electroweak-19.pdf>.
- [370] Gfitter Group Collaboration, M. Baak, J. Cúth, J. Haller, A. Hoecker, R. Kogler, K. Mönig, M. Schott, and J. Stelzer, *The global electroweak fit at NNLO and prospects for the LHC and ILC*, *Eur. Phys. J.* **C74** (2014) 3046, [arXiv:1407.3792](https://arxiv.org/abs/1407.3792) [hep-ph].
- [371] Z. Liang, *Z and W Physics at CEPC*, <http://indico.ihep.ac.cn/getFile.py/access?contribId=32&sessionId=2&resId=1&materialId=slides&confId=4338>.

- [372] B. Coleppa, F. Kling, and S. Su, *Constraining Type II 2HDM in Light of LHC Higgs Searches*, *JHEP* **01** (2014) 161, [arXiv:1305.0002 \[hep-ph\]](#).
- [373] V. Barger, L. L. Everett, H. E. Logan, and G. Shaughnessy, *Scrutinizing the 125 GeV Higgs boson in two Higgs doublet models at the LHC, ILC, and Muon Collider*, *Phys. Rev.* **D88** (2013) no. 11, 115003, [arXiv:1308.0052 \[hep-ph\]](#).
- [374] G. Belanger, B. Dumont, U. Ellwanger, J. F. Gunion, and S. Kraml, *Global fit to Higgs signal strengths and couplings and implications for extended Higgs sectors*, *Phys. Rev.* **D88** (2013) 075008, [arXiv:1306.2941 \[hep-ph\]](#).
- [375] P. M. Ferreira, J. F. Gunion, H. E. Haber, and R. Santos, *Probing wrong-sign Yukawa couplings at the LHC and a future linear collider*, *Phys. Rev.* **D89** (2014) no. 11, 115003, [arXiv:1403.4736 \[hep-ph\]](#).
- [376] X.-F. Han and L. Wang, *Wrong sign Yukawa coupling of 2HDM with a scalar dark matter confronted with dark matter and Higgs data*, [arXiv:1708.06882 \[hep-ph\]](#).
- [377] S. Kanemura, M. Kikuchi, and K. Yagyu, *Fingerprinting the extended Higgs sector using one-loop corrected Higgs boson couplings and future precision measurements*, *Nucl. Phys.* **B896** (2015) 80–137, [arXiv:1502.07716 \[hep-ph\]](#).
- [378] S. Kanemura, M. Kikuchi, and K. Yagyu, *Radiative corrections to the Yukawa coupling constants in two Higgs doublet models*, *Phys. Lett.* **B731** (2014) 27–35, [arXiv:1401.0515 \[hep-ph\]](#).
- [379] S. Kanemura, Y. Okada, E. Senaha, and C. P. Yuan, *Higgs coupling constants as a probe of new physics*, *Phys. Rev.* **D70** (2004) 115002, [arXiv:hep-ph/0408364 \[hep-ph\]](#).
- [380] N. Chen, T. Han, S. Su, W. Su, and Y. Wu, *Type-II 2HDM under the Precision Measurements at the Z-pole and a Higgs Factory*, In preparation.
- [381] JADE Collaboration, S. Bethke, S. Kluth, C. Pahl, and J. Schieck, *Determination of the Strong Coupling $\alpha(s)$ from hadronic Event Shapes with $O(\alpha^3(s))$ and resummed QCD predictions using JADE Data*, *Eur. Phys. J.* **C64** (2009) 351–360, [arXiv:0810.1389 \[hep-ex\]](#).
- [382] G. Dissertori, A. Gehrmann-De Ridder, T. Gehrmann, E. W. N. Glover, G. Heinrich, G. Luisoni, and H. Stenzel, *Determination of the strong coupling constant using matched NNLO+NLLA predictions for hadronic event shapes in e^+e^- annihilations*, *JHEP* **08** (2009) 036, [arXiv:0906.3436 \[hep-ph\]](#).
- [383] G. Dissertori, A. Gehrmann-De Ridder, T. Gehrmann, E. W. N. Glover, G. Heinrich, and H. Stenzel, *Precise determination of the strong coupling constant at NNLO in QCD from the three-jet rate in electron–positron annihilation at LEP*, *Phys. Rev. Lett.* **104** (2010) 072002, [arXiv:0910.4283 \[hep-ph\]](#).

- [384] OPAL Collaboration, G. Abbiendi et al., *Determination of α_s using OPAL hadronic event shapes at $\sqrt{s} = 91 - 209$ GeV and resummed NNLO calculations*, *Eur. Phys. J.* **C71** (2011) 1733, [arXiv:1101.1470 \[hep-ex\]](#).
- [385] JADE Collaboration, J. Schieck, S. Bethke, S. Kluth, C. Pahl, and Z. Trocsanyi, *Measurement of the strong coupling α_s from the three-jet rate in $e+e-$ annihilation using JADE data*, *Eur. Phys. J.* **C73** (2013) no. 3, 2332, [arXiv:1205.3714 \[hep-ex\]](#).
- [386] R. A. Davison and B. R. Webber, *Non-Perturbative Contribution to the Thrust Distribution in $e+e-$ Annihilation*, *Eur. Phys. J.* **C59** (2009) 13–25, [arXiv:0809.3326 \[hep-ph\]](#).
- [387] R. Abbate, M. Fickinger, A. H. Hoang, V. Mateu, and I. W. Stewart, *Precision Thrust Cumulant Moments at N^3LL* , *Phys. Rev.* **D86** (2012) 094002, [arXiv:1204.5746 \[hep-ph\]](#).
- [388] T. Gehrmann, G. Luisoni, and P. F. Monni, *Power corrections in the dispersive model for a determination of the strong coupling constant from the thrust distribution*, *Eur. Phys. J.* **C73** (2013) no. 1, 2265, [arXiv:1210.6945 \[hep-ph\]](#).
- [389] A. H. Hoang, D. W. Kolodrubetz, V. Mateu, and I. W. Stewart, *C -parameter distribution at N^3LL including power corrections*, *Phys. Rev.* **D91** (2015) no. 9, 094017, [arXiv:1411.6633 \[hep-ph\]](#).
- [390] A. H. Hoang, D. W. Kolodrubetz, V. Mateu, and I. W. Stewart, *Precise determination of α_s from the C -parameter distribution*, *Phys. Rev.* **D91** (2015) no. 9, 094018, [arXiv:1501.04111 \[hep-ph\]](#).
- [391] T. Becher and M. D. Schwartz, *A precise determination of α_s from LEP thrust data using effective field theory*, *JHEP* **07** (2008) 034, [arXiv:0803.0342 \[hep-ph\]](#).
- [392] Y.-T. Chien, R. Kelley, M. D. Schwartz, and H. X. Zhu, *Resummation of Jet Mass at Hadron Colliders*, *Phys. Rev.* **D87** (2013) no. 1, 014010, [arXiv:1208.0010 \[hep-ph\]](#).
- [393] A. Kardos, S. Kluth, G. Somogyi, Z. Tulipánt, and A. Verbytskyi, *Precise determination of $\alpha_s(M_Z)$ from a global fit of energy-energy correlation to NNLO+NNLL predictions*, [arXiv:1804.09146 \[hep-ph\]](#).
- [394] I. Moulton and H. X. Zhu, *Simplicity from Recoil: The Three-Loop Soft Function and Factorization for the Energy-Energy Correlation*, [arXiv:1801.02627 \[hep-ph\]](#).
- [395] Z. Nagy and Z. Trocsanyi, *Next-to-leading order calculation of four jet observables in electron positron annihilation*, *Phys. Rev.* **D59** (1999) 014020, [arXiv:hep-ph/9806317 \[hep-ph\]](#). [Erratum: *Phys. Rev.* **D62**, 099902(2000)].

- [396] OPAL Collaboration, G. Abbiendi et al., *Determination of $\alpha(s)$ using jet rates at LEP with the OPAL detector*, *Eur. Phys. J.* **C45** (2006) 547–568, [arXiv:hep-ex/0507047](#) [hep-ex].
- [397] A. Gehrmann-De Ridder, T. Gehrmann, E. W. N. Glover, and G. Heinrich, *Second-order QCD corrections to the thrust distribution*, *Phys. Rev. Lett.* **99** (2007) 132002, [arXiv:0707.1285](#) [hep-ph].
- [398] A. Gehrmann-De Ridder, T. Gehrmann, E. W. N. Glover, and G. Heinrich, *NNLO corrections to event shapes in e^+e^- annihilation*, *JHEP* **12** (2007) 094, [arXiv:0711.4711](#) [hep-ph].
- [399] S. Weinzierl, *NNLO corrections to 3-jet observables in electron-positron annihilation*, *Phys. Rev. Lett.* **101** (2008) 162001, [arXiv:0807.3241](#) [hep-ph].
- [400] V. Del Duca, C. Duhr, A. Kardos, G. Somogyi, and Z. Trócsányi, *Three-Jet Production in Electron-Positron Collisions at Next-to-Next-to-Leading Order Accuracy*, *Phys. Rev. Lett.* **117** (2016) no. 15, 152004, [arXiv:1603.08927](#) [hep-ph].
- [401] V. Del Duca, C. Duhr, A. Kardos, G. Somogyi, Z. Szőr, Z. Trócsányi, and Z. Tulipánt, *Jet production in the CoLoRFulNNLO method: event shapes in electron-positron collisions*, *Phys. Rev.* **D94** (2016) no. 7, 074019, [arXiv:1606.03453](#) [hep-ph].
- [402] S. Badger, C. Brønnum-Hansen, H. B. Hartanto, and T. Peraro, *First look at two-loop five-gluon scattering in QCD*, *Phys. Rev. Lett.* **120** (2018) no. 9, 092001, [arXiv:1712.02229](#) [hep-ph].
- [403] S. Abreu, F. Febres Cordero, H. Ita, B. Page, and M. Zeng, *Planar Two-Loop Five-Gluon Amplitudes from Numerical Unitarity*, [arXiv:1712.03946](#) [hep-ph].
- [404] T. Gehrmann, J. M. Henn, and N. A. Lo Presti, *Analytic form of the two-loop planar five-gluon all-plus-helicity amplitude in QCD*, *Phys. Rev. Lett.* **116** (2016) no. 6, 062001, [arXiv:1511.05409](#) [hep-ph]. [Erratum: *Phys. Rev. Lett.* 116, no. 18, 189903 (2016)].
- [405] C. G. Papadopoulos, D. Tommasini, and C. Wever, *The Pentabox Master Integrals with the Simplified Differential Equations approach*, *JHEP* **04** (2016) 078, [arXiv:1511.09404](#) [hep-ph].
- [406] A. Banfi, H. McAslan, P. F. Monni, and G. Zanderighi, *The two-jet rate in e^+e^- at next-to-next-to-leading-logarithmic order*, *Phys. Rev. Lett.* **117** (2016) no. 17, 172001, [arXiv:1607.03111](#) [hep-ph].
- [407] M. Dasgupta and G. P. Salam, *Accounting for coherence in interjet $E(t)$ flow: A Case study*, *JHEP* **03** (2002) 017, [arXiv:hep-ph/0203009](#) [hep-ph].
- [408] A. Banfi, G. Marchesini, and G. Smye, *Away from jet energy flow*, *JHEP* **08** (2002) 006, [arXiv:hep-ph/0206076](#) [hep-ph].

- [409] R. B. Appleby and M. H. Seymour, *Nonglobal logarithms in interjet energy flow with kt clustering requirement*, **JHEP** **12** (2002) 063, [arXiv:hep-ph/0211426](#) [hep-ph].
- [410] M. Rubin, *Non-Global Logarithms in Filtered Jet Algorithms*, **JHEP** **05** (2010) 005, [arXiv:1002.4557](#) [hep-ph].
- [411] A. Banfi, M. Dasgupta, K. Khelifa-Kerfa, and S. Marzani, *Non-global logarithms and jet algorithms in high- p_T jet shapes*, **JHEP** **08** (2010) 064, [arXiv:1004.3483](#) [hep-ph].
- [412] R. Kelley, M. D. Schwartz, and H. X. Zhu, *Resummation of jet mass with and without a jet veto*, [arXiv:1102.0561](#) [hep-ph].
- [413] A. Hornig, C. Lee, I. W. Stewart, J. R. Walsh, and S. Zuberi, *Non-global Structure of the $O(\alpha_s^2)$ Dijet Soft Function*, **JHEP** **08** (2011) 054, [arXiv:1105.4628](#) [hep-ph]. [Erratum: JHEP10,101(2017)].
- [414] A. J. Larkoski and I. Moult, *Nonglobal correlations in collider physics*, **Phys. Rev. D** **93** (2016) no. 1, 014012, [arXiv:1510.05657](#) [hep-ph].
- [415] H. Weigert, *Nonglobal jet evolution at finite $N(c)$* , **Nucl. Phys. B** **685** (2004) 321–350, [arXiv:hep-ph/0312050](#) [hep-ph].
- [416] Y. Hatta and T. Ueda, *Resummation of non-global logarithms at finite N_c* , **Nucl. Phys. B** **874** (2013) 808–820, [arXiv:1304.6930](#) [hep-ph].
- [417] Y. Hagiwara, Y. Hatta, and T. Ueda, *Hemisphere jet mass distribution at finite N_c* , **Phys. Lett. B** **756** (2016) 254–258, [arXiv:1507.07641](#) [hep-ph].
- [418] M. D. Schwartz and H. X. Zhu, *Nonglobal logarithms at three loops, four loops, five loops, and beyond*, **Phys. Rev. D** **90** (2014) no. 6, 065004, [arXiv:1403.4949](#) [hep-ph].
- [419] K. Khelifa-Kerfa and Y. Delenda, *Non-global logarithms at finite N_c beyond leading order*, **JHEP** **03** (2015) 094, [arXiv:1501.00475](#) [hep-ph].
- [420] S. Caron-Huot, *Resummation of non-global logarithms and the BFKL equation*, **JHEP** **03** (2018) 036, [arXiv:1501.03754](#) [hep-ph].
- [421] A. J. Larkoski, I. Moult, and D. Neill, *Non-Global Logarithms, Factorization, and the Soft Substructure of Jets*, **JHEP** **09** (2015) 143, [arXiv:1501.04596](#) [hep-ph].
- [422] T. Becher, M. Neubert, L. Rothen, and D. Y. Shao, *Effective Field Theory for Jet Processes*, **Phys. Rev. Lett.** **116** (2016) no. 19, 192001, [arXiv:1508.06645](#) [hep-ph].
- [423] D. Neill, *The Edge of Jets and Subleading Non-Global Logs*, [arXiv:1508.07568](#) [hep-ph].
- [424] T. Becher, M. Neubert, L. Rothen, and D. Y. Shao, *Factorization and Resummation for Jet Processes*, **JHEP** **11** (2016) 019, [arXiv:1605.02737](#) [hep-ph]. [Erratum: JHEP05,154(2017)].

- [425] A. J. Larkoski, I. Moulton, and D. Neill, *The Analytic Structure of Non-Global Logarithms: Convergence of the Dressed Gluon Expansion*, **JHEP** **11** (2016) 089, [arXiv:1609.04011 \[hep-ph\]](#).
- [426] T. Becher, B. D. Pecjak, and D. Y. Shao, *Factorization for the light-jet mass and hemisphere soft function*, **JHEP** **12** (2016) 018, [arXiv:1610.01608 \[hep-ph\]](#).
- [427] D. Neill, *The Asymptotic Form of Non-Global Logarithms, Black Disc Saturation, and Gluonic Deserts*, **JHEP** **01** (2017) 109, [arXiv:1610.02031 \[hep-ph\]](#).
- [428] T. Becher, R. Rahn, and D. Y. Shao, *Non-global and rapidity logarithms in narrow jet broadening*, **JHEP** **10** (2017) 030, [arXiv:1708.04516 \[hep-ph\]](#).
- [429] J. Gao, *Probing light-quark Yukawa couplings via hadronic event shapes at lepton colliders*, [arXiv:1608.01746 \[hep-ph\]](#).
- [430] LHC Higgs Cross Section Working Group Collaboration, J. R. Andersen et al., *Handbook of LHC Higgs Cross Sections: 3. Higgs Properties*, [arXiv:1307.1347 \[hep-ph\]](#).
- [431] HFLAV Collaboration, Y. Amhis et al., *Averages of b -hadron, c -hadron, and τ -lepton properties as of summer 2016*, **Eur. Phys. J. C** **77** (2017) no. 12, 895, [arXiv:1612.07233 \[hep-ex\]](#).
- [432] L. Gladilin, *Fragmentation fractions of c and b quarks into charmed hadrons at LEP*, **Eur. Phys. J. C** **75** (2015) no. 1, 19, [arXiv:1404.3888 \[hep-ex\]](#).
- [433] M. Lisovyi, A. Verbytskyi, and O. Zenaiev, *Combined analysis of charm-quark fragmentation-fraction measurements*, **Eur. Phys. J. C** **76** (2016) no. 7, 397, [arXiv:1509.01061 \[hep-ex\]](#).
- [434] C. Bobeth, M. Gorbahn, T. Hermann, M. Misiak, E. Stamou, and M. Steinhauser, *$B_{s,d} \rightarrow l^+l^-$ in the Standard Model with Reduced Theoretical Uncertainty*, **Phys. Rev. Lett.** **112** (2014) 101801, [arXiv:1311.0903 \[hep-ph\]](#).
- [435] LHCb Collaboration, R. Aaij et al., *Measurement of the $B_s^0 \rightarrow \mu^+\mu^-$ branching fraction and effective lifetime and search for $B^0 \rightarrow \mu^+\mu^-$ decays*, **Phys. Rev. Lett.** **118** (2017) no. 19, 191801, [arXiv:1703.05747 \[hep-ex\]](#).
- [436] CDF Collaboration, T. Aaltonen et al., *Search for the Decays $B_s^0 \rightarrow e^+\mu^-$ and $B_s^0 \rightarrow e^+e^-$ in CDF Run II*, **Phys. Rev. Lett.** **102** (2009) 201801, [arXiv:0901.3803 \[hep-ex\]](#).
- [437] J. Albrecht, F. Bernlochner, M. Kenzie, S. Reichert, D. Straub, and A. Tully, *Future prospects for exploring present day anomalies in flavour physics measurements with Belle II and LHCb*, [arXiv:1709.10308 \[hep-ph\]](#).
- [438] L3 Collaboration, M. Acciarri et al., *Search for neutral B meson decays to two charged leptons*, **Phys. Lett. B** **391** (1997) 474–480.
- [439] BaBar Collaboration, B. Aubert et al., *A search for the rare decay $B^0 \rightarrow \tau^+\tau^-$ at BABAR*, **Phys. Rev. Lett.** **96** (2006) 241802, [arXiv:hep-ex/0511015 \[hep-ex\]](#).

- [440] LHCb Collaboration, R. Aaij et al., *Search for the decays $B_s^0 \rightarrow \tau^+\tau^-$ and $B^0 \rightarrow \tau^+\tau^-$* , *Phys. Rev. Lett.* **118** (2017) no. 25, 251802, [arXiv:1703.02508 \[hep-ex\]](#).
- [441] E. Kou et al., *The Belle II Physics Book*, 2018.
<http://inspirehep.net/record/1117445/files/arXiv:1206.1230.pdf>.
- [442] LHCb Collaboration, R. Aaij et al., *Test of lepton universality using $B^+ \rightarrow K^+\ell^+\ell^-$ decays*, *Phys. Rev. Lett.* **113** (2014) 151601, [arXiv:1406.6482 \[hep-ex\]](#).
- [443] LHCb Collaboration, R. Aaij et al., *Test of lepton universality with $B^0 \rightarrow K^{*0}\ell^+\ell^-$ decays*, *JHEP* **08** (2017) 055, [arXiv:1705.05802 \[hep-ex\]](#).
- [444] LHCb Collaboration, R. Aaij et al., *Angular analysis of the $B^0 \rightarrow K^{*0}\mu^+\mu^-$ decay using 3 fb^{-1} of integrated luminosity*, *JHEP* **02** (2016) 104, [arXiv:1512.04442 \[hep-ex\]](#).
- [445] BaBar Collaboration, K. Flood, *New results in radiative electroweak penguin decays at BaBar*, *PoS ICHEP2010* (2010) 234.
- [446] J. F. Kamenik, S. Monteil, A. Semkiv, and L. V. Silva, *Lepton polarization asymmetries in rare semi-tauonic $b \rightarrow s$ exclusive decays at FCC-ee*, *Eur. Phys. J. C* **77** (2017) no. 10, 701, [arXiv:1705.11106 \[hep-ph\]](#).
- [447] M. D. Straub, *$B \rightarrow K^{(*)}\nu\bar{\nu}$ SM predictions*, BELLE2-MEMO-2016-007 (2015).
- [448] BaBar Collaboration, J. P. Lees et al., *Search for $B \rightarrow K^{(*)}\nu\bar{\nu}$ and invisible quarkonium decays*, *Phys. Rev.* **D87** (2013) no. 11, 112005, [arXiv:1303.7465 \[hep-ex\]](#).
- [449] L. Calibbi, F. Goertz, D. Redigolo, R. Ziegler, and J. Zupan, *Minimal axion model from flavor*, *Phys. Rev.* **D95** (2017) no. 9, 095009, [arXiv:1612.08040 \[hep-ph\]](#).
- [450] P. Urquijo, *Extrapolation of $B \rightarrow K^{(*)}\nu\bar{\nu}$ to the full Belle II dataset*, BELLE2-MEMO-2016-008 (2016).
- [451] C. Bobeth and U. Haisch, *New Physics in $\Gamma_{12}^s: (\bar{s}b)(\bar{\tau}\tau)$ Operators*, *Acta Phys. Polon.* **B44** (2013) 127–176, [arXiv:1109.1826 \[hep-ph\]](#).
- [452] U. Haisch, *(No) New physics in B_s mixing and decay*, in *2012 Electroweak Interactions and Unified Theories: Proceedings of the 47th Rencontres de Moriond on Electroweak Interactions and Unified Theories, La Thuile, March 3-10, 2012*, pp. 219–226. 2012. [arXiv:1206.1230 \[hep-ph\]](#).
<http://inspirehep.net/record/1117445/files/arXiv:1206.1230.pdf>.
- [453] BaBar Collaboration, J. P. Lees et al., *Evidence for an excess of $\bar{B} \rightarrow D^{(*)}\tau^-\bar{\nu}_\tau$ decays*, *Phys. Rev. Lett.* **109** (2012) 101802, [arXiv:1205.5442 \[hep-ex\]](#).

- [454] W. Altmannshofer, S. Gori, M. Pospelov, and I. Yavin, *Quark flavor transitions in $L_\mu - L_\tau$ models*, *Phys. Rev.* **D89** (2014) 095033, [arXiv:1403.1269](#) [[hep-ph](#)].
- [455] W. Altmannshofer and I. Yavin, *Predictions for lepton flavor universality violation in rare B decays in models with gauged $L_\mu - L_\tau$* , *Phys. Rev.* **D92** (2015) no. 7, [075022](#), [arXiv:1508.07009](#) [[hep-ph](#)].
- [456] S. L. Glashow, D. Guadagnoli, and K. Lane, *Lepton Flavor Violation in B Decays?*, *Phys. Rev. Lett.* **114** (2015) 091801, [arXiv:1411.0565](#) [[hep-ph](#)].
- [457] B. Bhattacharya, A. Datta, D. London, and S. Shivashankara, *Simultaneous Explanation of the R_K and $R(D^{(*)})$ Puzzles*, *Phys. Lett.* **B742** (2015) 370–374, [arXiv:1412.7164](#) [[hep-ph](#)].
- [458] A. Greljo, G. Isidori, and D. Marzocca, *On the breaking of Lepton Flavor Universality in B decays*, *JHEP* **07** (2015) 142, [arXiv:1506.01705](#) [[hep-ph](#)].
- [459] ALEPH Collaboration, S. Schael et al., *Branching ratios and spectral functions of tau decays: Final ALEPH measurements and physics implications*, *Phys. Rept.* **421** (2005) 191–284, [arXiv:hep-ex/0506072](#) [[hep-ex](#)].
- [460] A. Pich, *Precision Tau Physics*, *Prog. Part. Nucl. Phys.* **75** (2014) 41–85, [arXiv:1310.7922](#) [[hep-ph](#)].
- [461] Belle Collaboration, K. Belous et al., *Measurement of the τ -lepton lifetime at Belle*, *Phys. Rev. Lett.* **112** (2014) no. 3, 031801, [arXiv:1310.8503](#) [[hep-ex](#)].
- [462] BaBar Collaboration, B. Aubert et al., *Measurements of Charged Current Lepton Universality and $|V_{us}|$ using Tau Lepton Decays to $e^- \bar{\nu}_e \nu_\tau$, $\mu^- \bar{\nu}_\mu \nu_\tau$, $\pi^- \nu_\tau$ and $K^- \nu_\tau$* , *Phys. Rev. Lett.* **105** (2010) 051602, [arXiv:0912.0242](#) [[hep-ex](#)].
- [463] F. Feruglio, P. Paradisi, and A. Pattori, *Revisiting Lepton Flavor Universality in B Decays*, *Phys. Rev. Lett.* **118** (2017) no. 1, 011801, [arXiv:1606.00524](#) [[hep-ph](#)].
- [464] C. Cornella, F. Feruglio, and P. Paradisi, *Low-energy Effects of Lepton Flavour Universality Violation*, [arXiv:1803.00945](#) [[hep-ph](#)].
- [465] LHCb Collaboration, R. Aaij et al., *Search for the lepton flavour violating decay $\tau^- \rightarrow \mu^- \mu^+ \mu^-$* , *JHEP* **02** (2015) 121, [arXiv:1409.8548](#) [[hep-ex](#)].
- [466] L3 Collaboration, O. Adriani et al., *Search for lepton flavor violation in Z decays*, *Phys. Lett.* **B316** (1993) 427–434.
- [467] OPAL Collaboration, R. Akers et al., *A Search for lepton flavor violating $Z0$ decays*, *Z. Phys.* **C67** (1995) 555–564.
- [468] DELPHI Collaboration, P. Abreu et al., *Search for lepton flavor number violating $Z0$ decays*, *Z. Phys.* **C73** (1997) 243–251.

- 1 [469] ATLAS Collaboration, G. Aad et al., *Search for the lepton flavor violating decay*
2 *$Z \rightarrow e\mu$ in pp collisions at \sqrt{s} TeV with the ATLAS detector*, **Phys. Rev. D****90**
3 (2014) no. 7, 072010, [arXiv:1408.5774](https://arxiv.org/abs/1408.5774) [hep-ex].
- 4 [470] CMS Collaboration Collaboration, *Search for Lepton Flavor Violation in Z decays*
5 *in pp collisions at $\sqrt{s} = 8$ TeV*, CMS-PAS-EXO-13-005, CERN, Geneva, 2015.
6 <http://cds.cern.ch/record/2019863>.
- 7 [471] ATLAS Collaboration, M. Aaboud et al., *A search for lepton-flavor-violating*
8 *decays of the Z boson into a τ -lepton and a light lepton with the ATLAS detector*,
9 Submitted to: Phys. Rev. (2018) , [arXiv:1804.09568](https://arxiv.org/abs/1804.09568) [hep-ex].
- 10 [472] S. Monteil, *Flavour Physics beyond the current foreseen programs. A closer look*
11 *at Future Circular Colliders*, PoS **BEAUTY2016** (2016) 058.

Draft-V1.0

CHAPTER 3

EXPERIMENTAL CONDITIONS, PHYSICS REQUIREMENTS AND DETECTOR CONCEPTS

1 The CEPC physics program spans a wide range of center-of-mass energies and beam lu-
2 minosities to achieve the highest yields of Z , W and Higgs bosons produced in the excep-
3 tionally clean environment of an e^+e^- collider. As described in Chapter 2, the CEPC data
4 will provide new levels of high precision tests of the Standard Model and in the search for
5 new physics. This chapter describes the design requirements for the CEPC detectors to
6 achieve these physics goals, taking into account the CEPC collision environment and the
7 related backgrounds. The CEPC precision physics program places stringent requirements
8 on the detector performance. These include large and precisely defined solid angle cov-
9 erage, precise track momentum resolution, high efficiency vertex reconstruction, precise
10 photon energy reconstruction, excellent particle identification, excellent jet reconstruction
11 and flavor tagging.

12 Three preliminary CEPC detector concepts are introduced in this chapter. They derive
13 from detector concepts introduced for the International Linear Collider project, benefit-
14 ing from a long period of prior development, and incorporate modifications motivated by
15 the circular collider experimental environment and by the higher luminosity. Although
16 the overall design and main building blocks of the three concepts are similar, the partic-
17 ular technology choices are different. The CEPC baseline detector is based on a 3 Tesla
18 solenoid magnetic field and follows closely the International Large Detector (ILD) design.
19 It is guided by particle flow principles and it includes an ultra high granularity calorime-
20 ter system and a Time Projection Chamber (TPC). An alternative proposal substitutes the
21 TPC with a full-silicon tracker (FST). A third design based on a lower magnetic field of 2
22 Tesla, a drift chamber, and dual readout calorimetry is also presented. While the baseline
23 concept detector is used for the physics performance studies in this Conceptual Design
24 Report, the other two designs are considered fully valid alternatives. The final two CEPC

1 detectors are likely to be composed of the detector technologies included in any of these
2 three concepts.

3 3.1 CEPC Experimental Conditions

4 The CEPC is an electron-positron collider with 100 km circumference and two interaction
5 points (IP). The details of the full CEPC accelerator complex are described in the CDR
6 Volume I [1]. The final stage of the CEPC complex is a double-ring collider. Electron and
7 positron beams circulate in opposite directions in separate beam pipes. They collide at
8 two interaction points (IPs) where are located large detectors, the specifications of which
9 are presented in this volume.

10 The detectors must operate in three primary sets of conditions, corresponding to three
11 different center-of-mass energies (\sqrt{s}): Higgs factory ($e^+e^- \rightarrow ZH$) at $\sqrt{s} \sim 240$ GeV, Z
12 boson factory ($e^+e^- \rightarrow Z$) at $\sqrt{s} \sim 91.2$ GeV and W threshold scan ($e^+e^- \rightarrow W^+W^-$)
13 at $\sqrt{s} \sim 160$ GeV. The instantaneous luminosities are expected to reach 3×10^{34} , 32×10^{34}
14 and 10×10^{34} $\text{cm}^{-2}\text{s}^{-1}$, respectively, as shown in Table 3.2, and will remain relatively
15 constant throughout operation through a process of full-energy top-up injection by the
16 CEPC accelerator complex. The current tentative operation plan will allow the detectors
17 to collect one million Higgs bosons or more, close to one trillion Z boson events, and ten
18 million W^+W^- event pairs.

19 The detector designs must comprehensively meet the requirements imposed by the
20 CEPC experimental conditions and the physics program. Each of the beam conditions
21 and corresponding detector implications are presented below.

22 3.1.1 The CEPC beam

23 The detectors will record collisions in beam conditions presented in Figure 3.1. Several of
24 these parameters impose important constraints on the detectors. The bunch spacing of the
25 colliding beams differ greatly in the three operational modes (25 ns, 210 ns, and 680 ns,
26 respectively) as does the power dissipated into synchrotron radiation (16.5 MW for Z
27 factory and 30 MW for W threshold scan and Higgs factory). Other important differences
28 are also present in the expected beam backgrounds, described in more detail below, and,
29 most importantly, in the event rates and types of events to be recorded, according to the
30 cross sections shown in Figure 3.1 for different center-of-mass energies.

31 3.1.2 Beam backgrounds

32 Three most important sources of radiation backgrounds are evaluated for the CEPC:

- 33 1. synchrotron radiation photons from the last bending dipole magnet
- 34 2. e^+e^- pair production following the beamstrahlung process
- 35 3. off-energy beam particles lost in the interaction region

36 3.1.2.1 Synchrotron radiation

37 Synchrotron radiation (SR) photons are critical at circular machines. A large flux SR
38 photons are generated in the last bending dipole magnets. They are then transported to the
39 interaction region with the BDSim software [2]. They can hit the central beam pipe, either

	Higgs	W	Z (3T)	Z (2T)
Number of IPs	2			
Beam energy (GeV)	120	80	45.5	
Circumference (km)	100			
Synchrotron radiation loss/turn (GeV)	1.73	0.34	0.036	
Crossing angle at IP (mrad)	16.5×2			
Piwinski angle	3.48	7	23.8	
Bunch number	242	1524	12000 (10% gap)	
Bunch spacing (ns)	680	210	25	
No. of particles/bunch $N_e(10^{10})$	15	12	8	
Beam current (mA)	17.4	87.9	461	
Synch. radiation power (MW)	30	30	16.5	
Bending radius (km)	10.7			
β function at IP: β_x^* (m)	0.36	0.36	0.2	0.2
β_y^* (m)	0.0015	0.0015	0.0015	0.001
Emittance: x (nm)	1.21	0.54	0.18	0.18
y (nm)	0.0024	0.0016	0.004	0.0016
Beam size at IP: σ_x (μm)	20.9	13.9	6.0	6.0
σ_y (μm)	0.06	0.049	0.078	0.04
Beam-beam parameters: ξ_x	0.018	0.013	0.004	0.004
ξ_y	0.109	0.123	0.06	0.079
RF voltage V_{RF} (GV)	2.17	0.47	0.1	
RF frequency f_{RF} (MHz)	650			
Natural bunch length σ_z (mm)	2.72	2.98	2.42	
Bunch length σ_z (mm)	4.4	5.9	8.5	
Natural energy spread (%)	0.1	0.066	0.038	
Energy spread (%)	0.134	0.098	0.08	
Photon number due to beamstrahlung	0.082	0.05	0.023	
Lifetime (hour)	0.43	1.4	4.6	2.5
F (hour glass)	0.89	0.94	0.99	
Luminosity/IP ($10^{34} \text{ cm}^{-2}\text{s}^{-1}$)	3	10	17	32

Table 3.1: Main beam parameters for the CEPC operation at three center-of-mass energies. The detector solenoid magnetic field affects the beam quality in the Z-factory operation mode. The last two columns compare the beam parameters for the case of a two- or three-Tesla detector solenoid.

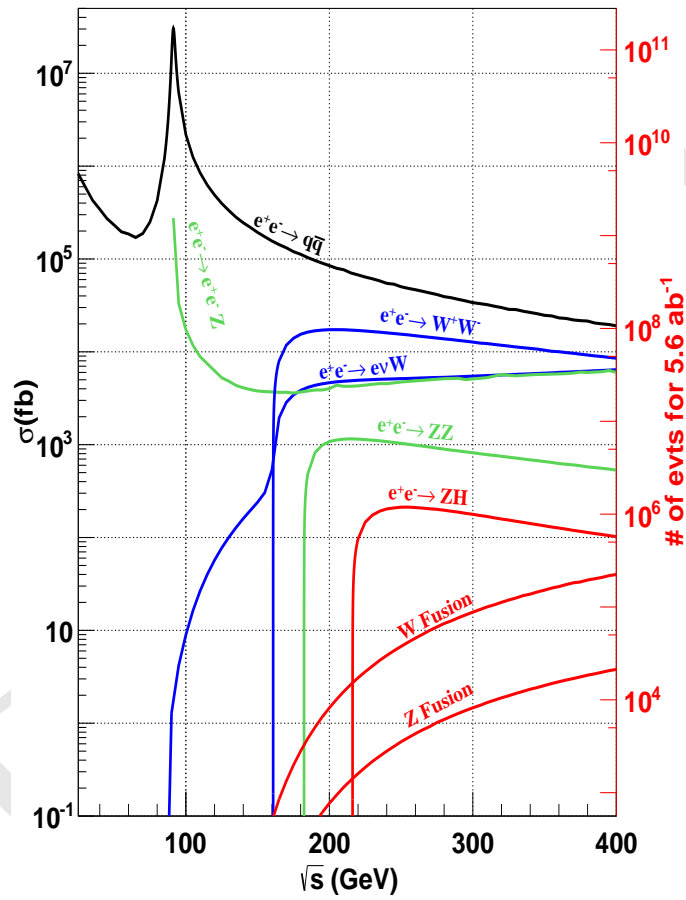

Figure 3.1: Cross sections of the leading Standard Model processes for unpolarized electron-positron collisions and the numbers of events expected in 5.6 ab^{-1} the data of a integrated luminosity. They are Higgs production: Higgs bremsstrahlung, W fusion, and Z fusion; The dominant 2-fermions background: $e^+e^- \rightarrow q\bar{q}$; The 4-fermions backgrounds: $e^+e^- \rightarrow W^+W^-$, ZZ , $e^+\nu W$, and e^+e^-Z , etc.

Operation mode	Z factory	W threshold scan	Higgs factory
\sqrt{s} (GeV)	91.2	158 - 172	240
L ($10^{34}\text{cm}^{-2}\text{s}^{-1}$)	16-32	10	3
Running time (years)	2	1	7
Integrated Luminosity (ab^{-1})	8 - 16	2.6	5.6
Higgs yield	-	-	10^6
W yield	-	10^7	10^8
Z yield	10^{11-12}	10^9	10^9

Table 3.2: Instantaneous and integrated luminosities at different values of center-of-mass energy (\sqrt{s}) and anticipated corresponding boson yields at the CEPC. The range of luminosities for the Z factory correspond to the two possible solenoidal magnetic fields, 3 or 2 Tesla.

1 directly or after scattered by the beam pipe in the forward region. SR photons can also be
2 generated in the final focusing magnets but contribute little to the detector backgrounds
3 because they are produced with extremely small polar angles and can leave the interaction
4 region without interacting in the beam pipe. To suppress the SR photons, three sets of
5 mask tips made with high- Z material are introduced at $|z| = 1.51, 1.93$ and 4.2 m away
6 from the interaction point. The studies prove that the masks can reduce effectively the
7 number of SR photons hitting the central beam pipe, from almost 40,000 to below 80
8 from one of the two beams per bunch crossing. Further optimization may suppress SR
9 photons even more and make this particular background well controlled.

10 3.1.2.2 Pair production

11 Electron-positron pairs are produced via the interaction of beamstrahlung photons with
12 the strong electromagnetic fields of the colliding bunches. Pair production, in particu-
13 lar the incoherent pair production, represents the most important detector background at
14 CEPC. The process is simulated with GUINEAPIG [3] and interfaced to GEANT4 [4–6]
15 for detector simulation. Despite of the magnitude of beam squeezing being different in x
16 and y directions, the hit distribution is almost uniform in the azimuthal (ϕ) direction. The
17 resulting hit density at the first vertex detector layer ($r = 1.6$ cm) is about 2.2 hits/ cm^2
18 per bunch crossing when running at $\sqrt{s} = 240$ GeV. The total ionizing energy (TID) and
19 non-ionizing energy loss (NIEL) are 620 kRad/year and 1.2×10^{12} 1 MeV $n_{eq}/\text{cm}^2 \cdot \text{year}$,
20 respectively. For the background estimation, safety factors of ten are applied to cope with
21 the uncertainties on the event generation and the detector simulation.

22 3.1.2.3 Off-energy beam particles

23 Beam particles after losing a certain amount of energy, *i.e.* 1.5% of the nominal beam en-
24 ergy, can be kicked off their orbit. Such off-energy beam particles may hit machine and/or
25 detector elements close to the interaction region and give rise to important backgrounds.
26 The three main scattering process are radiative Bhabha scattering, beamstrahlung and
27 beam-gas interaction. After the introduction of two sets of collimators upstream of the
28 IPs, backgrounds due to beamstrahlung and beam-gas interaction become negligible. The
29 residual backgrounds due to radiative Bhabha scattering yields hit densities of about 0.22

1 hits/cm² per bunch crossing when operating at $\sqrt{s} = 240$ GeV. The corresponding TID
 2 and NIEL are 310 kRad/year and 9.3×10^{11} 1 MeV $n_{eq}/\text{cm}^2 \cdot \text{year}$, respectively.

3 3.1.2.4 Backgrounds at different energies

4 When operating the machine at the center-of-mass energy of $\sqrt{s} = 240$ GeV, the main
 5 detector backgrounds come from the pair-production and off-energy beam particles. At
 6 lower operational energies, *i.e.* $\sqrt{s} = 160$ GeV for W and $\sqrt{s} = 91$ GeV for Z , the back-
 7 ground particles are usually produced with lower energies but with higher rates given the
 8 higher machine luminosities. The pair-production becomes dominant, while contributions
 9 from other sources tend to be negligible.

10 3.2 Physics Requirements

11 As Higgs, Z , and W boson factories, the CEPC should be equipped with detectors that
 12 can identify all the corresponding physics objects with high efficiency, high purity and
 13 measure them with high precision. In addition, the CEPC physics program requires a
 14 precise determination of the instant luminosity, a precise control and monitoring of the
 15 beam energy. Generally, the CEPC detector is required to:

- 16 1 Operate reliably at high efficiency in the CEPC collision environment. The detector
 17 should be fast enough to record all the physics events with excellent efficiency and
 18 meet the performance requirements throughout the CEPC operation, including being
 19 robust against beam backgrounds.
- 20 2 Provide highly hermetic coverage for physics events. The detector should provide a
 21 solid angle coverage of $|\cos(\theta)| < 0.99$.
- 22 3 Accurately record the integrated luminosity. The luminosity should be measured to
 23 a relative accuracy of 0.1% for the Higgs factory operation, and 10^{-4} for the Z line
 24 shape scan.
- 25 4 The beam energy should be measured to an accuracy of the order of 1 MeV for the
 26 Higgs factory operation, and 100 keV for the Z pole and W mass threshold scan,
 27 following the methods described in [7].

28 The requirements on the physics objects reconstruction are briefly quantified with bench-
 29 mark physics analyses, see discussion below.

30 3.2.1 Multiplicity

31 In each physics event, the visible final state particles include the electrons, muons, charged
 32 hadrons, photons, and neutral hadrons. The multiplicities of these three basic ingredients,
 33 with the charged particles collectively described as tracks, are shown in Figure 3.2 for
 34 the WW , ZZ , and ZH processes (the leading SM processes) at the CEPC Higgs factory
 35 operation.

36 The charged tracks and the photons carry most of the visible energies and are much nu-
 37 merous than the neutral hadrons. They follow a similar distribution of multiplicity, which
 38 can be as high as $\mathcal{O}(10^2)$. These final state particles can have extremely small angles in
 39 between, especially for those generated in high energy jets. An efficient separation of

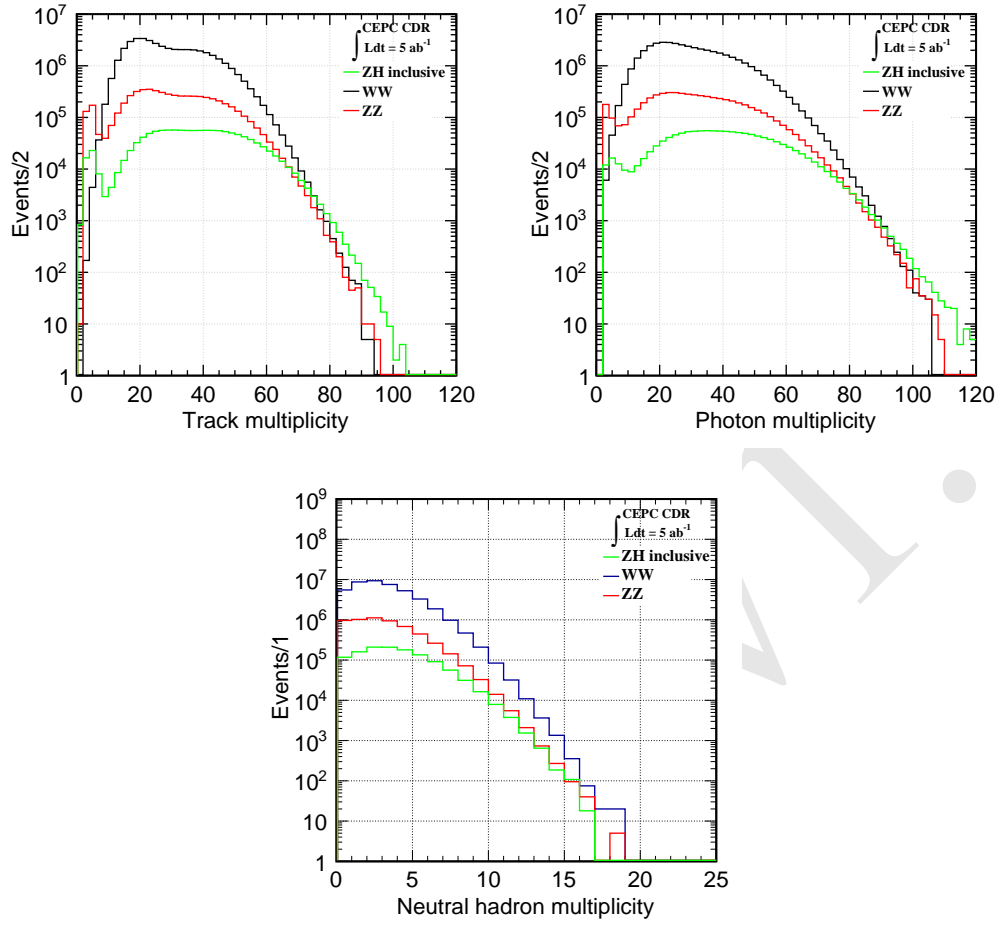

Figure 3.2: The multiplicities of charged particles, photons, and neutral hadrons from the WW , ZZ , and ZH events at the CEPC Higgs operation (corresponding to non-polarized electron positron collision at 240 GeV center of mass energy), normalized to 5 ab^{-1} integrated luminosity. The multiplicities of tracks and photons those events can be as high as one hundred, 5 times larger than that of neutral hadrons. These physics events with large multiplicity request a detector that can efficiently separate of the final state particles.

- 1 these final state particles provides a solid basis for the reconstruction of all the physics
- 2 objects, which is addressed explicitly by the Particle Flow Principle.

3 3.2.2 Tracking

- 4 The CEPC detector should have excellent track finding efficiency and track momentum
- 5 resolution. Corresponding to the WW , ZZ and the ZH processes at the CEPC Higgs
- 6 factory operation, the energy and polar angle distributions of the charged particles are
- 7 shown in Figure 3.3.

- 8 In the polar angle distribution, the ZH process is almost flat in the polar angle direction,
- 9 while the other two processes are more forward region dominated. A large solid angle
- 10 coverage is essential to characterize and to distinguish different physics processes, and
- 11 a coverage of $|\cos(\theta)| = 0.99$ is benchmarked. In the energy distribution, these three
- 12 processes share the same pattern. For energies below 20 GeV, these distributions follow

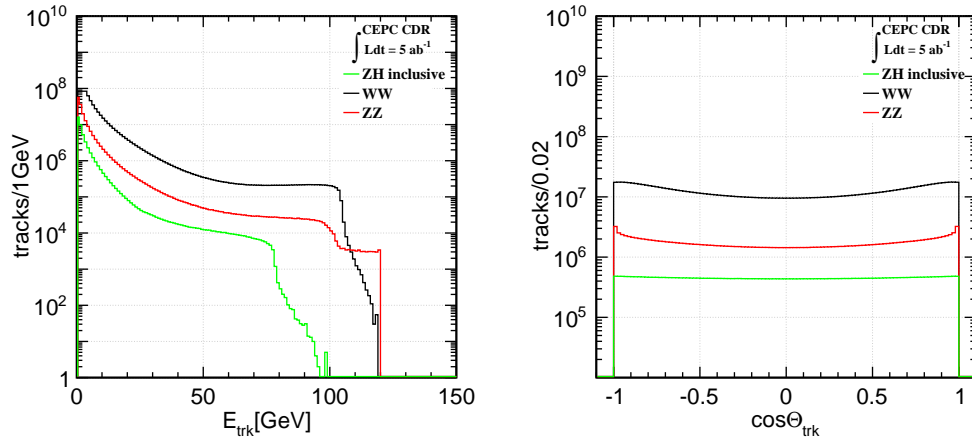

Figure 3.3: The energy and polar angle distributions of charged particles from the WW , ZZ , and ZH events at the CEPC Higgs operation, normalized to 5 ab^{-1} integrated luminosity. The ZH events is flatly distributed along the $\cos(\theta)$ while the other two processes are peaked at forward region.

1 an exponential distribution, while in the high energy side there is a flat plateau with a steep
 2 cliff. Therefore, the CEPC detector should have a high efficiency track reconstruction,
 3 especially for these low energy tracks. Meanwhile, it should have an excellent momentum
 4 resolution and linearity for a wide energy range (0.1–120 GeV).

5 For any tracks within the detector acceptance and a transverse momentum larger than
 6 1 GeV, we request an track finding efficiency better than 99%. In order to measure the
 7 $H \rightarrow \mu^+ \mu^-$ signal and to reconstruct precisely the Higgs boson mass from the recoil mass
 8 distribution at $\ell^+ \ell^- H$ events, the momentum resolution is required to achieve a per mille
 9 level relative accuracy.

10 3.2.3 Charged Leptons

11 The charged lepton is one of the most important physics signatures and it plays a crucial
 12 role in the classification of different physics events. A high efficiency and high purity
 13 charged lepton identification is fundamental for the CEPC physics program.

14 At the CEPC Higgs factory operation, roughly 7% of the Higgs bosons are generated
 15 with a pair of charged leptons. These $\ell^+ \ell^- H$ samples are the golden signal for the Higgs
 16 boson recoil mass analyses. Figure 3.4 shows the energy distribution of the prompt leptons
 17 and these generated in Higgs boson decay cascade. The prompt muons in $\mu^+ \mu^- H$ events
 18 have a flat energy distribution within the kinematic range (20–100 GeV) and a low energy
 19 tail induced by the Z boson width and final state radiation (FSR). The prompt electron-
 20 positron pair in $e^+ e^- H$ events follows a similar pattern, except the population increases
 21 at energy smaller than 10 GeV. This low-energy peak is mainly induced by the Z fusion
 22 events where one of the two scattered electrons is produced with low momentum.

23 The Higgs boson decay also generates leptons, which is mostly concentrated in the
 24 low energy side, but can have energies as high as 70 GeV. These high energy leptons are
 25 mainly generated from $H \rightarrow \tau^+ \tau^-$, ZZ^* , WW^* decay cascades.

26 The basic requirements on the lepton identification for the CEPC detector is, to identify
 27 the prompt charged leptons with high efficiency and high purity. Therefore, we require

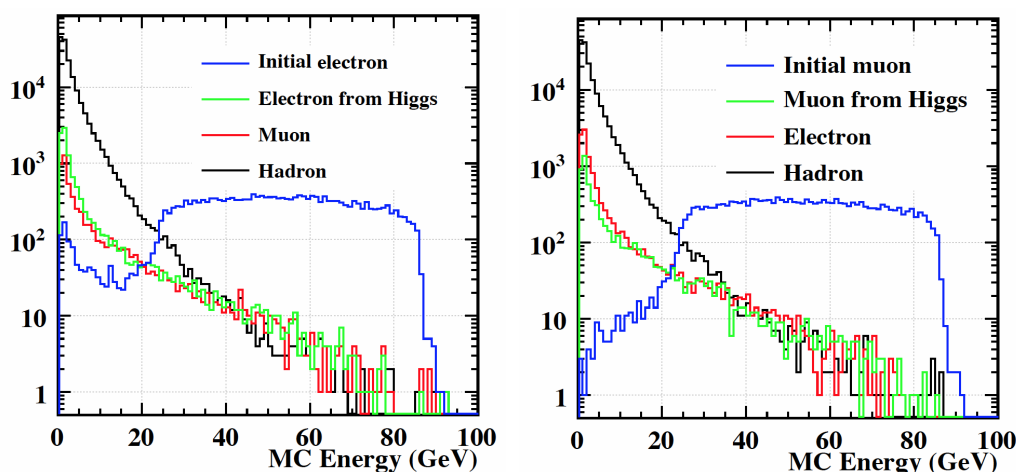

Figure 3.4: The energy spectrum of the prompt leptons and the charged particles in the e^+e^-H events (left) and the $\mu^+\mu^-H$ events (right). Most of the prompt leptons are generated from the Z boson decay in the $ZH, Z \rightarrow \ell^+\ell^-$ events, therefore, their energy spectrum exhibits a flat plateau from 20 to 90 GeV. Therefore, the CEPC detector is required to identify those leptons with high efficiency and high purity. The prompt electron/positron energy spectrum in the e^+e^-H events (the left plot) exhibit a tiny low energy peak, which is induced from the Z fusion events.

1 a lepton identification with efficiency higher than 99% and misidentification rate smaller
 2 than 2% for energetic isolated leptons (energetic means energy higher than 5 GeV). These
 3 requirements are also essential for the identification of $H \rightarrow \tau^+\tau^-$ events and the semi-
 4 leptonic/leptonic decays modes of $H \rightarrow ZZ^*, WW^*$ events.

5 The charged leptons produced in the numerous jets generated in the Higgs boson decay
 6 cascades can be crucial for the jet flavor tagging and jet charge reconstruction. Therefore,
 7 a good identification of leptons in jets is highly advantageous. More detailed study is
 8 needed to quantify the requirements on the lepton-in-jet identification.

9 3.2.4 Charged hadron identification

10 The particle identification, especially the identification of charged kaons, is crucial for
 11 the flavor physics. Similar to the jet leptons, the identification of charged kaon is highly
 12 appreciated for the jet flavor tagging and jet charge reconstruction. Typically, we request
 13 the efficiency and purity of the kaon identification at the inclusive Z pole sample to be
 14 better than 90%.

15 3.2.5 Photons

16 The photons are crucial for the jet energy resolution, the $H \rightarrow \gamma\gamma$ branching ratio mea-
 17 surements, radiative processes and the physics with τ final states. Figure 3.5 shows the
 18 energy and polar angle distributions for the inclusive photons, and the initial-state radia-
 19 tion (ISR) photons in Figure 3.6, from these benchmark physics processes at the CEPC
 20 Higgs factory operation.

21 As for the photon reconstruction, we request a photon identification efficiency higher
 22 than 99% and a misidentification rate smaller than 5%, for unconverted, isolated photons
 23 with energy higher than 1 GeV. To observe at least 50% of di-photon resonances with
 24 a pair of unconverted photons, the material budget in front of the calorimeter should be

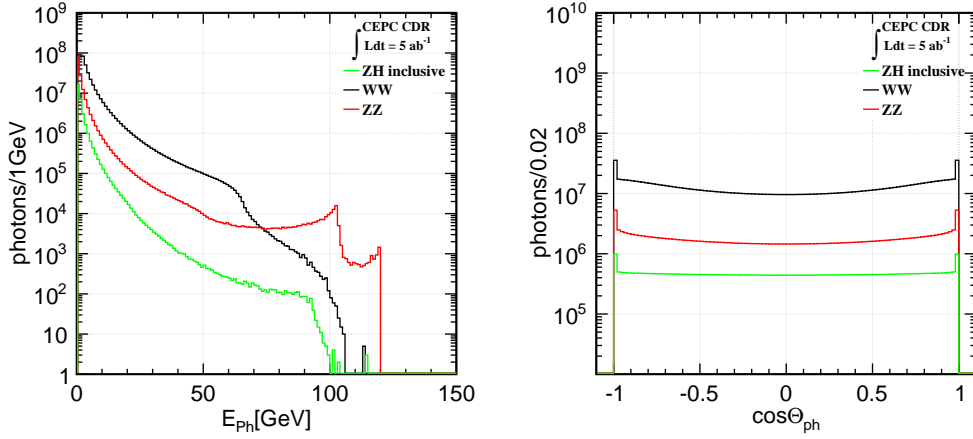

Figure 3.5: The energy and polar angle distributions of all photons from WW , ZZ , and ZH events at the CEPC Higgs operation, normalized to 5 ab^{-1} integrated luminosity. In the energy spectra, the distribution corresponding to ZZ events exhibits a peak near 100 GeV, which is induced from the ISR return events. The tiny peak at the polar angle distribution at the very forward region is corresponding to the ISR photons, see also the next plot.

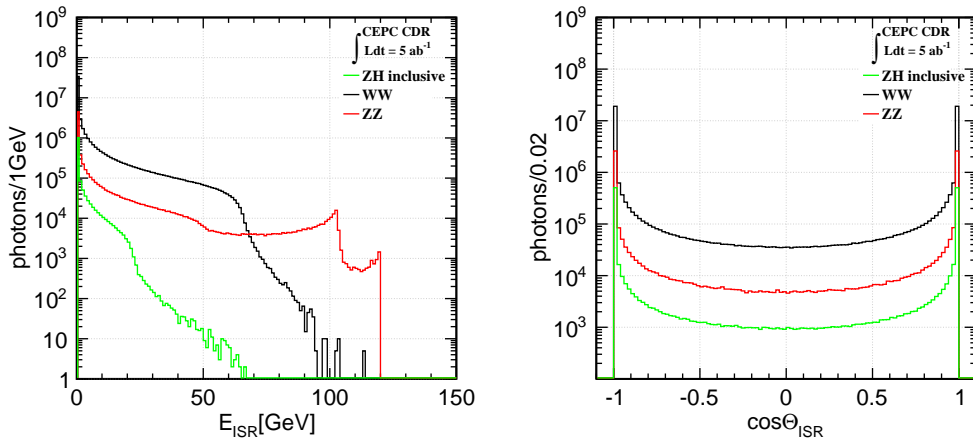

Figure 3.6: The energy and polar angle distributions of ISR photons from WW , ZZ , and ZH events at the CEPC Higgs operation, normalized to 5 ab^{-1} integrated luminosity. These ISR photons are concentrated at forward region (see the right hand plot).

1 less than $0.35X_0$ averaged over all solid angle. To identify the τ leptons with different
 2 decay modes, the photons should be identified from the π^0 with an efficiency and purity
 3 higher than 95% from the $Z \rightarrow \tau^+\tau^-$ event sample at CEPC Z factory operation. To
 4 fully exploit the hadronic decays of the Z , W , and Higgs bosons, the requirements on
 5 the jet energy resolution, described in the next section, impose a photon energy resolution
 6 requirement of better than $20\%/\sqrt{E} \oplus 1\%$. This photon energy resolution requirement
 7 for jets is sufficient to meet the needs of the $g(H\gamma\gamma)$ measurement at CEPC due to the
 8 low background environment for the di-photon final state. Further evaluation of photon
 9 energy resolution requirements for radiative processes need to be carefully studied.

10 3.2.6 Jets and Missing energy

11 The reconstruction of jets is essential for the CEPC physics program, since the major-
 12 ity of W , Z , and Higgs bosons decay into hadronic final states. Jets are measured with
 13 particles that interact with the full range of sub-detector systems. The Particle Flow prin-
 14 ciple and corresponding particle flow algorithms (PFA), based upon it, are an overarching
 15 approach to reconstructing and interpreting measurements into a form that identifies and
 16 optimally measures the properties and kinematic quantities of all individual final state par-
 17 ticles produced in the high-energy collision. For Particle Flow oriented detectors, the jet
 18 is constructed from a list of final state particles produced by the PFA. Therefore, the jet
 19 reconstruction is determined by the reconstruction of final state particles and the jet clus-
 20 tering algorithm. Consequently, the jet reconstruction performance should be evaluated at
 21 two stages.

22 The first is the Boson Mass Resolution (BMR) for massive SM bosons. The boson
 23 mass resolution represents the jet energy resolution with perfect jet clustering, or more
 24 accurately, a perfect identification of the color singlet. The BMR is defined as the relative
 25 resolution of the visible mass on the $\nu\bar{\nu}H$, $H \rightarrow gg$ events with a standard cleaning pro-
 26 cedure. The cleaning procedure has a typical efficiency of 65%, it vetoes the events with
 27 energetic visible ISR photon(s), energetic neutrinos generated in the Higgs boson decay,
 28 and jets pointing to the very forward regions. Since the width of the SM Higgs boson
 29 (4 MeV) is negligible comparing to the jet energy resolution (GeV), BMR is equivalently
 30 the Higgs boson mass resolution with cleaned $\nu\bar{\nu}H$, $H \rightarrow gg$ event sample.

31 Figure 3.7 shows the reconstructed W , Z , and Higgs boson masses with different BMR.
 32 In order to distinguish the W , Z , and the Higgs boson from their hadronic decay final state,
 33 a boson mass resolution better than 4% is required. It should be remarked that an efficient
 34 separation of individual W , Z , and Higgs boson is a prerequisite for a clear separation of
 35 WW , ZZ , and ZH events in the 4-jet final states, since the latter strongly depends on the
 36 jet clustering performance.

37 The missing energy measurement with jet final states can also be characterized by the
 38 BMR. The physics benchmark for the missing energy-momentum measurement is the
 39 $\text{BR}(H \rightarrow \text{invisible})$ measurement with $q\bar{q}H$ final states. The signal has a Higgs boson
 40 mass peak in the missing mass spectrum. The dominant SM background, the $ZZ \rightarrow \nu\bar{\nu}q\bar{q}$
 41 process, exhibits a peak at the Z boson mass. Meanwhile, because the initial state radia-
 42 tion and the heavy flavor component of the $Z \rightarrow q\bar{q}$ decay, both missing mass distributions
 43 exhibit a high mass tail. The missing mass distributions at different BMR are displayed
 44 in Figure 3.8. At a BMS worse than 4%, the Z recoil mass peak of the background be-

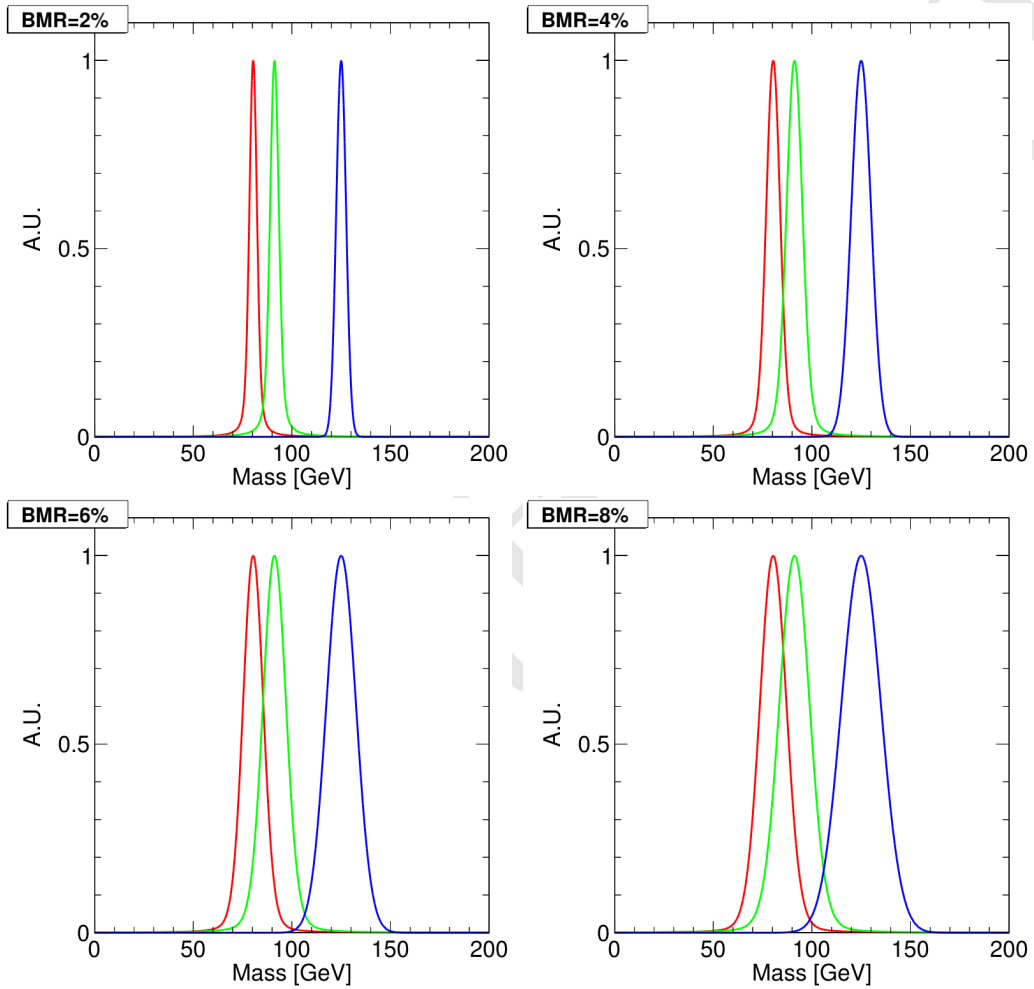

Figure 3.7: The invariant mass distributions of W , Z and Higgs bosons for different Boson Mass Resolutions (BMR), corresponding to the red, the green and the blue curves. Normalized to unit height. The distributions of the W and Z bosons are modeled with an Breit-Wigner Distribution with 2 and 2.5 GeV the width, convoluted with the relative BMR.

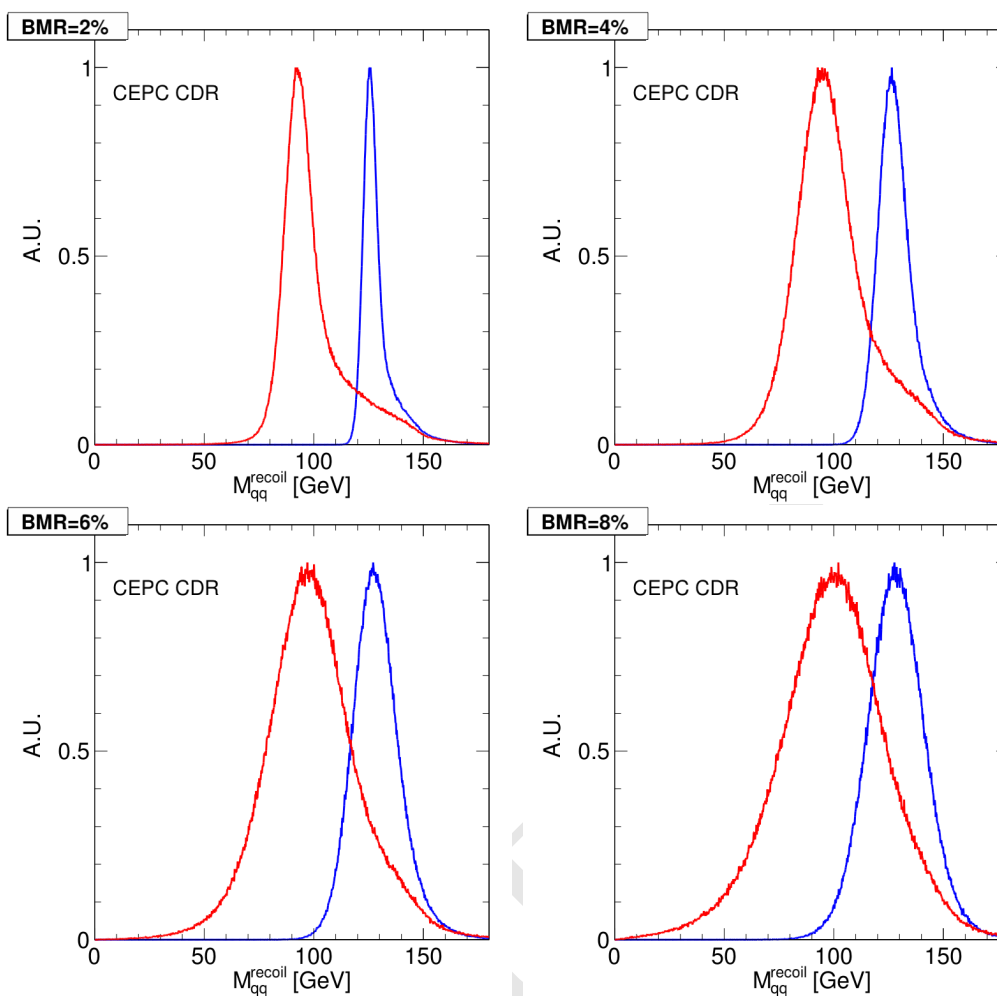

Figure 3.8: The di-jet recoil mass distribution of $ZZ \rightarrow v\bar{v}q\bar{q}$ events and ZH events with Z decays into a pair of quarks and the Higgs boson decaying invisibly at different Boson Mass Resolution (BMR). The red/blue curve is corresponding to the ZZ/ZH events, respectively. Each distribution is normalized to an unit height. At a BMR equal or smaller than 4%, the ZZ events exhibit a high recoil mass tail induced by the heavy flavor jets and the ISR photons; while at large BMR, this high mass tail got absorbed into the main peak with large intrinsic width.

1 comes so wide that it starts to overlap with the Higgs boson mass peak. Therefore, for this
 2 benchmark, a boson mass resolution better than 4% is certainly advantageous.

3 The identification of individual jets, and its energy-momentum reconstruction is crucial
 4 for the CEPC physics measurements. The individual jet energy response is highly depend-
 5 ing on the event topology and the jet clustering algorithms. Detailed analyses are required
 6 to disentangle the actual physics requirement, which need to be analyzed carefully.

7 3.2.7 Flavor Tagging

8 One of the key physics objectives of the CEPC Higgs program is to measure $g(Hc\bar{c})$. The
 9 CEPC detector is therefore required to efficiently distinguish the b -jets, the c -jets, and the
 10 light jets from each other. High performance flavor tagging is also highly advantageous in
 11 EW precision measurements.

Benchmarked with the $Z \rightarrow q\bar{q}$ sample at 91.2 GeV c.m.s, we require the b -jets to be identified with a efficiency and purity higher than 80%, and a c -jet identification efficiency/purity better than 60%.

The classification of different kinds of jets depends strongly on the reconstruction of secondary vertex, where the performance of the vertex system is crucial. The clean collision environment of the CEPC allows much aggressive vertex system design, a detailed vertex optimization study can be found in Section 4.1.3.

3.2.8 Requirements on the physics objects: summary

The discussion above quantifies the physics requirements on the physics object reconstruction. It can be summarized as:

- 1 Tracking performance: For tracks with transverse momentum greater than 1 GeV that are within the detector acceptance, a reconstruction efficiency of better than 99% is required. The relative resolution of the track momentum should achieve per mille level accuracy, required by the measurements of $g(H\mu\mu)$ and the Higgs boson recoil mass analyses with $\ell^+\ell^-H$ events.
- 2 Excellent lepton identification. For isolated leptons with a momentum larger than 5 GeV, we request an identification efficiency of 99% and accumulated misidentification rate smaller than 2%. The leptons inside the jets also need to be identified well, as they provide information on the jet flavor and jet charge.
- 3 Capability to identify charged kaons, which enhances the rich flavor physics program at CEPC Z factory operation. For the inclusive $Z \rightarrow q\bar{q}$ sample at $\sqrt{s} = 91.2$ GeV, we request a charged kaon identification with efficiency and purity to be both higher than 90%.
- 4 Precise reconstruction of photons. Required by the $g(H\gamma\gamma)$ measurement and the jet energy reconstruction, the photon energy should be measured to a precision better than $20\%/\sqrt{E} \oplus 1\%$. Meanwhile, to identify the τ leptons with different decay modes, the photons should be identified from the π^0 with an efficiency and purity higher than 95% in the $Z \rightarrow \tau^+\tau^-$ event sample at CEPC Z factory operation.
- 5 Excellent Jet/Missing Energy reconstruction. The jet/missing energy reconstruction is essential for the CEPC since most of the physics events are generated with one or more of these physics objects. To avoid the complication from jet clustering performance, we characterize the jet and missing energy reconstruction with Boson Mass Resolution. Benchmarking with the separation of massive SM bosons (W , Z , and Higgs boson) and the $\text{BR}(H \rightarrow \text{invisible})$ measurements, a BMR better than 4% is identified.
- 6 Capability to separate b -jets, c -jets and light jets (uds and gluon jets): required by the $g(Hb\bar{b})$, $g(Hc\bar{c})$, $g(Hgg)$, and the EW measurements. Benchmarking with the $Z \rightarrow q\bar{q}$ sample at $\sqrt{s} = 91.2$ GeV, we require the b -jets to be identified with an efficiency and purity higher than 80%, and a c -jet identification efficiency/purity better than 60%.

Most of the above-mentioned requirements are driven by the precision Higgs measurements. However, it also applies to the precise EW measurements as the W and Z bosons decay into similar physics objects.

3.3 Detector concepts

To address the physics requirements at the CEPC, two(three) different detector concepts are proposed.

The first (two) detector concept(s) is (are) guided by the Particle Flow Principle. The Particle Flow principle interprets all the detector signals as originating from final state particles. For each physics event, all the physics objects are reconstructed from a unique list of final state particles. The single particle level physics objects, for example the leptons, the photons, and the kaons, are identified directly from the final state particle list. The compound physics objects, for example the converted photons, the K_S^0 , the τ lepton and the jets, are identified using dedicated finding algorithms such as the τ finder and jet clustering algorithms. Subtracting the total visible four-momentum of all the final state particles from the initial four momentum determines the missing four-momentum. This global interpretation of the final state particles leads to high efficiency and high purity reconstruction of all the physics objects. In addition, the Particle Flow algorithm in principle associates the detector hits to each individual particle, therefore, the final state particle could be measured in the most-suited sub-detector system. For the charged particles, the relative accuracy of track momentum resolution from the tracking system is usually much better than the energy resolution from the calorimeter system. Therefore, the Particle Flow algorithm also significantly improves the accuracies on the energy reconstruction of compound objects, especially for the τ lepton and the jets.

The baseline detector geometry is named APODIS, which stands for A Particle Flow Oriented Detector for the Higgs factory. It was initially developed from the concept of International Large Detector (ILD, the baseline detector for the linear colliders). It is optimized for the CEPC collision environments, and enhances the particle identification performance which is essential for flavor physics. The APODIS uses an ultra high granularity calorimeter system to efficiently separate the final state particle showers, low material tracking system to limit the probability of interaction of final state particles in the tracking material, and a large volume solenoid that hosts the entire ECAL and HCAL inside. There are two options for its tracking system, the time-projection chamber (TPC) and the full silicon tracking (FST).

An alternative detector geometry, IDEA, is also proposed. IDEA uses a dual readout calorimeter to achieve excellent energy resolution for both electromagnetic and hadronic showers. Comparing to APODIS, IDEA uses a lower field solenoid but compensates with a large tracking volume. The IDEA is also used as a reference detector for FCC-ee studies.

The main detector parameters of both concepts are summarized in Table 3.3.

3.3.1 The baseline detector concept

From inner to outer, as shown in Figure 3.9, the baseline geometry is composed of a silicon pixel vertex system, a silicon internal tracker, a TPC main tracker, a Silicon-tungsten sampling ECAL, an Iron-Glass Resistive Plate Chamber HCAL, a solenoid, and a return yoke.

The baseline geometry has a dedicated design in the forward region and machine-detector interface (MDI). The L^* of the baseline geometry has a length of 2.2 meters, and a compensation solenoid system is installed at a z position of 1100–6000 mm. A luminosity calorimeter (LumiCal) is installed at the end of this nose structure. A compact,

Concept	ILD	CEPC baseline	IDEA
Tracker	TPC/Silicon	TPC/Silicon or FST	Drift Chamber/Silicon
Solenoid B-Field (T)	3.5	3	2
Solenoid Inner Radius (m)	3.4	3.2	2.1
Solenoid Length (m)	8.0	7.8	6.0
L^* (m)	3.5	2.2	2.2
VTX Inner Radius (mm)	16	16	16
Tracker Outer Radius (m)	1.81	1.81	2.05
Calorimeter	PFA	PFA	Dual readout
Calorimeter λ_I	6.6	5.6	7.5
ECAL Cell Size (mm)	5	10	-
ECAL Time resolution (ns)	-	200 ps/hit	-
ECAL X_0	24	24	-
HCAL Layer Number	48	40	-
HCAL Absorber	Fe	Fe	-
HCAL λ_I	5.9	4.9	-
DRCAL Cell Size (mm)	-	-	6.0
DRCAL Time resolution (ns)	-	-	100 ps/hit
DRCAL Absorber	-	-	Pb or Cu or Fe
Overall Height (m)	14.0	11.4	11.0
Overall Length (m)	13.2	11.1	13.0

Table 3.3: Comparison of detector parameters. [expand caption](#)

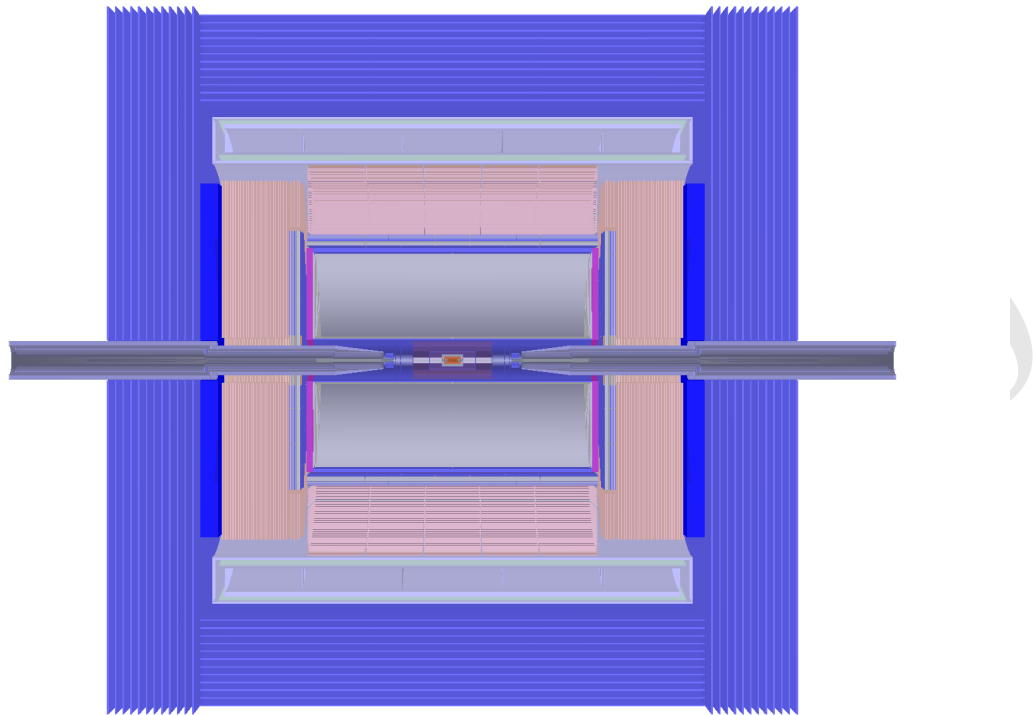

(a)

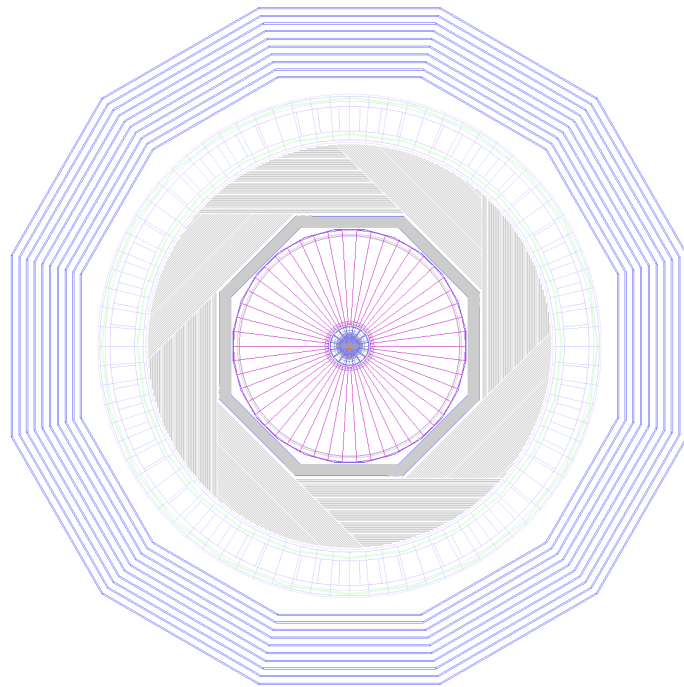

(b)

Figure 3.9: The RZ (a) and R- ϕ (b) view of the baseline detector geometry. The baseline geometry uses a double beam with 33 mrad crossing angle, and has a short L^* of 2.2 meter. In the central Barrel, from inner to outer, the baseline geometry is composed of a Vertex system, a Silicon Inner Tracker, a TPC, a Silicon External Tracker, an ECAL, an HCAL, a Solenoid of 3 Tesla and a Return Yoke. In the forward region, 5 pairs of tracking disks are installed to enlarge the tracker acceptance (from $|\cos(\theta)| < 0.99$ to $|\cos(\theta)| < 0.996$).

1 forward tracking system composed of 5 pairs of tracking disks is installed in between a
2 z position of 200–1000 mm.

3 The solenoid B-Field of the baseline is 3 Tesla. The CEPC uses a double ring config-
4 uration, with a crossing angle of 33 mrad at the interaction point. Each time the bunch
5 passing through the detector, the beam emittance increases via the coupling to the detector
6 solenoid B-Field (especially the vertical emittance). In order to achieve a high luminos-
7 ity, this solenoid B-Field needs to be compensated locally. Therefore, a compensating
8 solenoid is installed in the forward region of the CEPC detector. Considering the technol-
9 ogy challenge of the compensating solenoid and the physics requirements at the CEPC,
10 the baseline geometry uses a solenoid of 3 Tesla for CEPC Higgs factory operation, and
11 the central solenoid may be ramped down to 2 Tesla for CEPC Z factory operation.

12 The baseline geometry uses the Time Projection Chamber (TPC) as its main tracker.
13 The TPC provides good energy resolution, excellent track reconstruction efficiency, low
14 material budgets, and its dE/dx measurement is important for particle identification, see
15 Section 10.2.7. On the other hand, compared to the silicon tracking, the TPC is a slow
16 technology: the drift time of ions is of the order of one second in the APODIS TPC. In the
17 TPC, both primary ionization of charged tracks and ion backflow from the amplification
18 procedure generates ions, which accumulate in the gas volume. These ions will distort
19 the drift electric field and eventually limit the precision of track momentum measurement.
20 The physics event rate at the CEPC Z factory operation is of the order of 10^{3-4} Hz.
21 Therefore, ions generated from thousands of events pile up in the gas volume. The control
22 of backflow ion is then essential for the TPC operation.

23 Iterated with the hardware R&D, dedicated simulation studies are performed in the
24 CEPC TPC study. Using a double amplification layer, the ion backflow could be con-
25 trolled to per mille level without gating [8]. On the other hand, the simulation analysis
26 shows that at this level of ion backflow control, the degrading of spatial point resolution
27 is smaller than the intrinsic TPC spatial resolution. The TPC occupancy is also analyzed
28 at the CEPC Z factory. Those studies lead to the conclusion that the TPC is a feasible
29 technology option for the CEPC [9].

30 The TPC in the baseline has an inner radius of 0.3 meters, an outer radius of 1.8 meters,
31 and a length of 4.7 meters. It is divided into 220 radial layers, each has a thickness of
32 6 mm. Along the ϕ direction, each layer is segmented into 1 mm wide cells. In total,
33 the TPC has 1 million readout channels in each endcap. Operating in 3 Tesla solenoid
34 B-Field, the TPC provides a spatial resolution of $100 \mu\text{m}$ in the $R - \phi$ plane and $500 \mu\text{m}$
35 resolution in the Z direction for each tracker hit. The TPC reaches a standalone momen-
36 tum resolution of $\delta(1/P_t) \sim 10^{-4} \text{GeV}^{-1}$.

37 The baseline is equipped with large-area silicon tracking devices, including the pixel
38 vertex system, the forward tracking system, and the silicon inner/external tracking lay-
39 ers located at the boundary of the TPC. Combining the measurements from the sili-
40 con tracking system and the TPC, the track momentum resolution could be improved
41 to $\delta(1/P_t) \sim 2 \times 10^{-5} \text{GeV}^{-1}$. In fact, the TPC is mainly responsible for the pattern
42 recognition and track finding, while the silicon tracking devices dominate the momentum
43 measurement. The silicon pixel vertex system also provides precise impact parameter res-
44 olution ($\sim 5 \mu\text{m}$), which is highly advantageous for the τ lepton reconstruction and the jet
45 flavor tagging.

46 The baseline geometry uses a high granular sampling Electromagnetic Calorimeter
47 (ECAL) and Hadronic Calorimeter (HCAL). The calorimeter is responsible for separating

1 final state particle showers, measuring the neutral particle energy, and providing informa-
 2 tion for the lepton identification [10][11]. The entire ECAL and HCAL are installed inside
 3 the solenoid, providing 3-dimensional spatial position and the energy information. The
 4 ECAL geometry parameter is determined by a dedicated optimization study [12]. The
 5 ECAL is composed of 30 layers of alternating silicon sensors and tungsten absorber. It
 6 has a total absorber thickness of 84 mm. Transversely, each sensor layer is segmented
 7 into 10 mm by 10 mm cells. The HCAL uses Resistive Plate Chamber sensor and Iron ab-
 8 sorber. It has 40 longitudinal layers, each consists of a 25 mm Iron absorber. Transversely,
 9 it is segmented into 10 mm by 10 mm cells.

10 This calorimeter system provides good energy measurement for the neutral particles
 11 (i.e. roughly $16\%/\sqrt{E/\text{GeV}}$ for the photons and $60\%/\sqrt{E/\text{GeV}}$ for the neutral hadrons).
 12 More importantly, it records enormous information of the shower spatial development,
 13 ensuring efficient separation between nearby showers and providing essential information
 14 for the lepton identification, see Section 10.2.1. In addition, the silicon-tungsten ECAL
 15 could provide precise time measurements. Requesting a cluster level time resolution of
 16 50 ps, the ECAL Time-of-Flight (ToF) measurement plays a complementary role to the
 17 TPC dE/dx measurement, leading to good charged Kaon identification performance, see
 18 Section 10.2.7.

19 As will be introduced in the following chapter, the baseline geometry maintains the
 20 same performance for the CEPC Higgs boson measurements comparing to the ILD. Mean-
 21 while, the total cost, the total weight, and the calorimeter thickness have been significantly
 22 optimized (by 25%, 50% and 20% respectively). In addition, the baseline geometry has
 23 good performance for charged kaon identification, which is highly advantageous for flavor
 24 physics and in the jet flavor/charge reconstruction.

25 3.3.2 Full silicon detector concept

26 Silicon detectors provide at present the most precise tracking for charged particles in high
 27 energy physics experiments. They have an excellent space point resolution and granular-
 28 ity to cope track separation in dense jets and hits from the high luminosity beam related
 29 background. A full-silicon tracker (FST) would offer a competitive choice of detector
 30 concepts for CEPC that provides excellent tracking efficiency, momenta resolution, and
 31 vertexing capability for charged particles from the interaction point as well as from the
 32 decay of secondary particles. The challenge is to build it with minimal material to pre-
 33 serve the momentum resolution and being covered hermetically down to the dip angle of
 34 $|\cos\theta| < 0.992$ from the beam pipe.

35 Here we will demonstrate that the full-silicon tracking concept is a viable option for
 36 CEPC by replacing the TPC with additional silicon stereo-strip layers while keeping the
 37 rest of detector unchanged under the same detector boundary conditions used by the CEPC
 38 baseline concept described above. We so far have not changed the detector boundary con-
 39 ditions such as the B field and the track volume in order to provide a cost-optimized
 40 detector since the performance may not matter. However, within these boundary con-
 41 ditions, we have optimized the layout with the number of silicon layers, single- versus
 42 double-sided layers, and support materials using a toy simulation. This concept option is
 43 described below in Section 4.3.

44 Two approaches are considered for the design: the first is to keep the silicon detectors
 45 (VXD, SIT, FTD) in the CEPC baseline detector and replacing TPC with additional silicon

1 detectors, as shown in Figure 3.10 for 3D view of a full and zoomed detector; the second
 2 is to optimize the ILC-SID tracker to fulfill the CEPC tracking volume in order to achieve
 3 the excellent momentum resolution using 3 Tesla B field. The new detector geometry has
 4 been implemented in the simulation and the track reconstruction has also been adopted
 5 for the full silicon tracker. The initial study of the tracking performance looks promising.
 6 There are still many improvements needed in the simulation and reconstruction in order
 7 to explore the full potential of the full-silicon tracker.

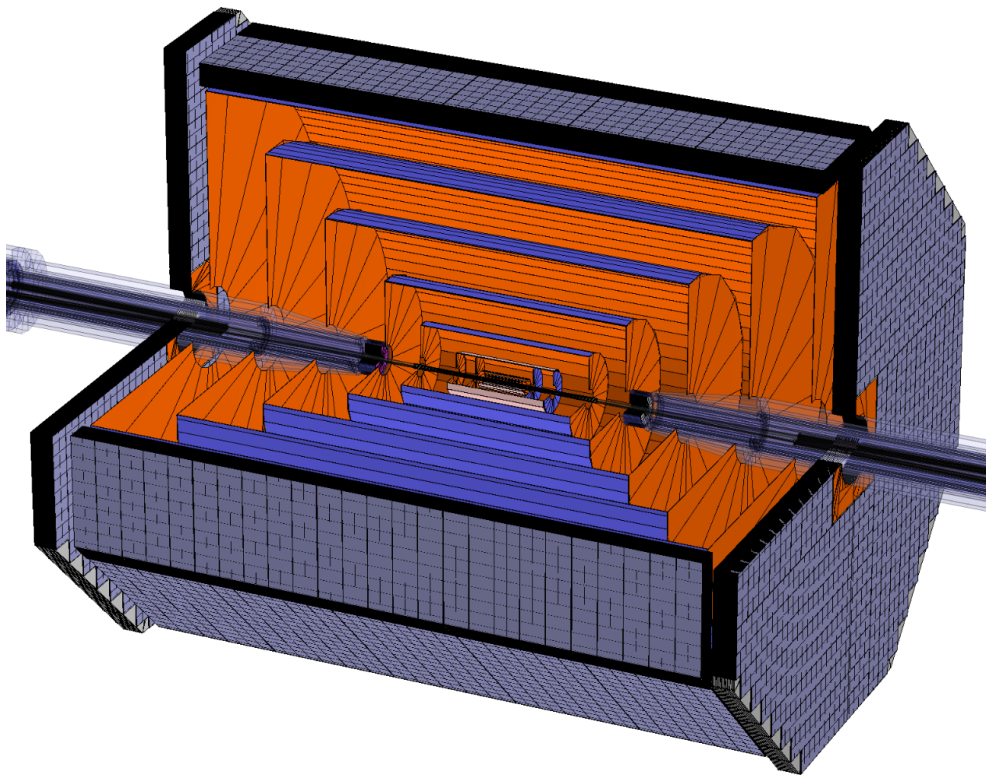

Figure 3.10: Schematic 3-D view of the FST detector and the zoomed full-silicon tracker.

8 3.3.3 An alternative low magnetic field detector concept

9 Remove any mention of the name IDEA and substitute it with alternative detector?

10 The baseline detector described in this CDR is a very straightforward evolution of the
 11 ILD detector originally conceived for the International Linear Collider (ILC) [13]. We
 12 propose here a new detector concept, IDEA (Innovative Detector for Electron-positron
 13 Accelerator), that is specifically designed for a circular electron-positron collider and also
 14 attempts to economize on the overall cost of the detector.

15 While most detector requirements needed for detectors at ILC are very similar to those
 16 for CEPC [14], there are however some notable differences. First of all the typical lumi-
 17 nosity expected both at the Z pole ($\sqrt{s} = 90$ GeV) and above the ZH threshold ($\sqrt{s} =$
 18 240 GeV) is expected to be one or two orders of magnitude larger, with a much shorter
 19 bunch spacing and no large time gaps in the beam structure. This places severe con-
 20 straints on the tracking system. In particular one would prefer an intrinsically fast main
 21 tracker to fully exploit the cleanliness of the e^+e^- environment while integrating as little

background as possible, and a very low-power vertex detector, since power pulsing is not allowed by the bunch spacing. Additional issues of emittance preservation, typical of circular machines, set limits on the maximum magnetic field usable for the tracker solenoid, especially when running at lower center-of-mass energies. This could be a problem for a large volume TPC, due to the resolution degradation, and also for a silicon tracker, since it would require more layers at a large radius, thus significantly increasing the cost.

Additional specific requirements on a detector for CEPC come from precision physics at the Z pole, where the statistical accuracy on various electroweak parameters is expected to be over an order of magnitude better than at the ILC. This calls for a very tight control of the systematic error on the acceptance, with a definition of the acceptance boundaries at the level of a few μm , and a very good $e - \gamma - \pi_0$ discrimination to identify τ leptons efficiently and measure their polarization. A layer of silicon microstrip detectors around the main tracker can provide the needed acceptance control for charged tracks, while also improving the tracking resolution. Similarly, the acceptance accuracy and improved identification efficiency of γ 's can be obtained with a pre-shower based on micro-pattern gas detectors (MPGD) located just outside the detector magnet, which serves as a radiator.

The particle flow calorimeters, currently proposed for both ILC and CLIC, feature an extremely large number of readout channels and require significant data processing to obtain the optimal performance. A less expensive and more effective calorimeter can be made using the dual readout technique [15], which has been extensively studied and demonstrated in over ten years of R&D by the DREAM/RD52 collaboration [16, 17]. With this technology the electromagnetic and hadronic calorimeters come in a single package that plays both functions and allows an excellent discrimination between hadronic and electromagnetic showers [18]. Since all the readout electronics is located in the back of the calorimeter, its cooling is greatly simplified relative to the case of particle flow calorimeters.

Finally recent developments in micro-pattern gas detector technology, such as μRwell [19], can significantly reduce the cost of large area tracking chambers to be used for tracking muons outside the calorimeter volume.

The IDEA detector The structure of the IDEA detector is outlined in Figure 3.11, which also shows its overall dimensions.

A key element of IDEA is a thin, ~ 30 cm, and low mass, $\sim 0.8 X_0$, solenoid with a magnetic field of 2 Tesla. This field is optimal, according to studies done for FCC-ee, as it minimizes the impact on emittance growth and allows for manageable fields in the compensating solenoids [20], but it is certainly not optimal for a large TPC or a silicon tracker of reasonable size. The low mass and thickness of the solenoid allows it to be located between the calorimeter and the tracking volume without a significant performance loss.

The innermost detector, surrounding the 1.5 cm radius beam pipe, is a silicon pixel detector for the precise determination of the impact parameter of charged particle tracks. Recent test beam results on the detectors planned for the ALICE inner tracker system (ITS) upgrade, based on the ALPIDE readout chip [21], indicate an excellent resolution, $\sim 5 \mu\text{m}$, and high efficiency at low power and dark noise rate [22]. This looks like a good starting point for the IDEA vertex detector and a similar approach is proposed for the CEPC baseline detector (see Section 4.1). The two detector concepts could then share the

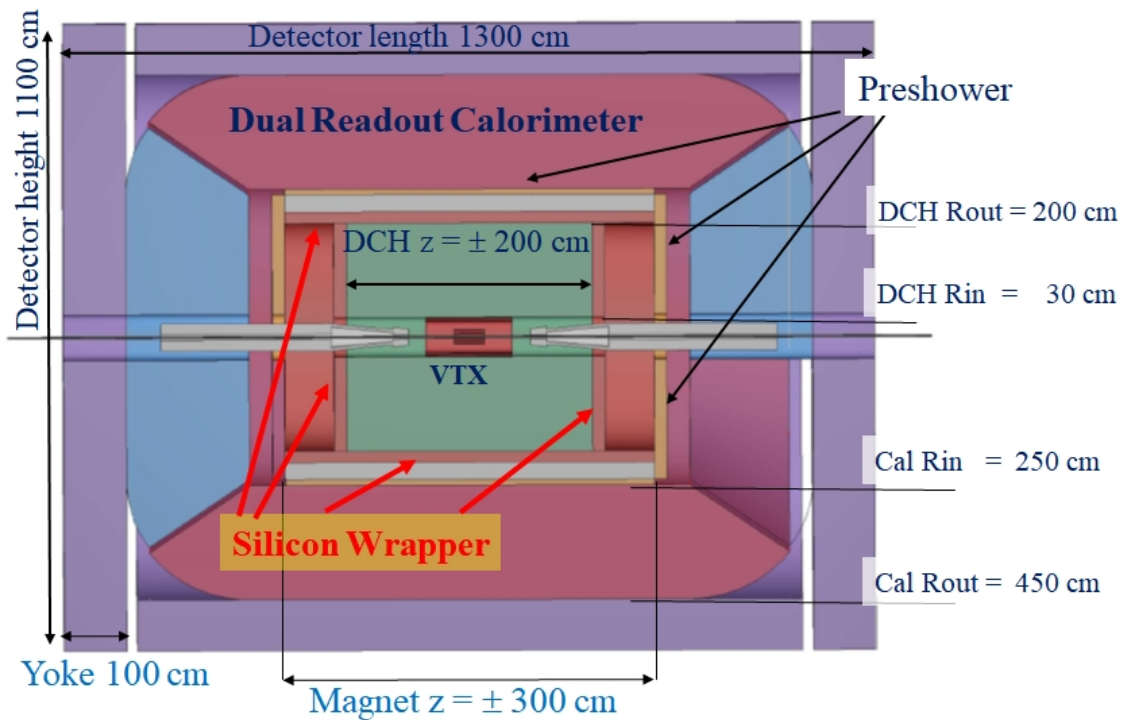

Figure 3.11: Schematic layout of the IDEA detector. [expand caption](#)

1 same pixel technology as well as profit from the electronic and mechanical work of the
2 ALICE ITS.

3 Outside the vertex detector we have a 4 m long cylindrical drift chamber starting from
4 a radius of ~ 35 cm and extending until 2 m. The chamber can be made extremely light,
5 with low mass wires and operation using 90% helium gas; less than 1% X_0 is considered
6 feasible for 90° tracks. Additional features of this chamber, which is described in detail in
7 Section 4.4, are a good spatial resolution, $< 100 \mu\text{m}$, dE/dx resolution at the 2% level and
8 a maximum drift time of only 400 ns. A layer of silicon microstrip detectors surrounds the
9 drift chamber in both barrel and forward/backward regions. Track momentum resolution
10 of less than 0.5% for 100 GeV tracks is expected when vertex detector and silicon wrapper
11 information is included in the track fit. It is worth noting that the design of this chamber is
12 the evolution of work done over many years on two existing chambers, that of the KLOE
13 detector [23] and that of the recent MEG experiment upgrade [24]; major R&D work was
14 done also for the 4th concept detector at ILC [25] and then for the Mu2E tracker [26].

15 A pre-shower is located between the solenoid magnet and the calorimeter in the barrel
16 region and between the drift chamber and the end-cap calorimeter in the forward region.
17 This detector consists of two passive material radiators each followed by a layer of MPGD
18 detectors. In the barrel region the solenoidal magnet plays the role of the first radiator,
19 while in all other cases the radiators are made of lead. The actual thickness of the radiators
20 are still being optimized based on test beams currently in progress. In the extreme case
21 of using a total of two radiation lengths about 75% of the π^0 's can be tagged by having
22 both γ 's from their decay identified by the pre-shower. Additional π^0 identification power
23 comes from the high granularity of the calorimeter.

1 A solenoidal magnet surrounds the tracking system and the first pre-shower layer.
 2 Presently planned dimensions are 6 m of length and 4.2 m inner diameter. The relatively
 3 low two Tesla field and the small dimensions have important implications on the overall
 4 magnet package thickness, that can be kept at the 30-40 cm level, and on the size of the
 5 flux return yoke, which scales linearly with the field and the square of the coil diameter.
 6 With the given dimensions a yoke thickness of less than 100 cm of iron is sufficient to
 7 completely contain the magnetic flux and provide adequate shielding and support for the
 8 muon chambers.

9 A dual readout fiber calorimeter (see Section 5.5) is located behind the second pre-
 10 shower layer. We assume a total calorimeter depth of 2 m, corresponding to approximately
 11 seven pion interaction lengths. The detector resolution is expected to be about $10.5\%/\sqrt{E}$
 12 for electrons and $35\%/\sqrt{E}$ for isolated pions with negligible constant terms, as obtained
 13 from extrapolations from test beam data using GEANT4 without including the pre-shower.
 14 This detector has very good intrinsic discrimination between muons, electrons/photons
 15 and hadrons for isolated particles [18]. This discrimination power is further enhanced
 16 when the information of the pre-shower and the muon chambers is added, extending the
 17 separation power also into hadronic jets and making it suitable for the application of par-
 18 ticle flow algorithms. The intrinsic high transverse granularity provides a good matching
 19 of showers to tracks and pre-shower signals.

20 The muon system consists of layers of muon chambers embedded in the magnet yoke.
 21 The area to be covered is substantial, several hundreds of square meters, requiring an
 22 inexpensive chamber technology. Recent developments in the industrialization of μ Rwell
 23 based large area chambers, as planned for the CMS Phase II upgrade, are very promising
 24 (see Section 7.3).

25 **Conclusions** A different concept for a detector at CEPC has been proposed. This de-
 26 tector is designed specifically for CEPC and its specific running conditions and physics
 27 goals. In particular it is safe with respect to interaction between the detector solenoid field
 28 and the beam. Although additional R&D to optimize performance, reduce costs and come
 29 to a detailed engineered design of the detector is still necessary, this detector is based on
 30 technologies which are established after many years of R&D and whose feasibility has
 31 by large been established. Furthermore several choices are made to simplify the detector
 32 structure and reduce the cost, which in the end should be smaller than for an ILD-like
 33 detector.

34 References

- 35 [1] The CEPC-SPPC Study Group, *CEPC-SPPC Conceptual Design Report, Volume I -*
 36 *Accelerator*, IHEP, Beijing, China, Rep. IHEP-CEPC-DR-2018-01 (2018) .
- 37 [2] I. Agapov, G. A. Blair, S. Malton, and L. Deacon, *BDSIM: A particle tracking code*
 38 *for accelerator beam-line simulations including particle-matter interactions*, *Nucl.*
 39 *Instrum. Meth.* **A606** (2009) 708–712.
- 40 [3] D. Schulte, *Beam-beam simulation with GUINEA-PIG*, In 5th International
 41 Computational Accelerator Physics Conference (1998) . CLIC-NOTE 387.
- 42 [4] GEANT4 Collaboration, S. Agostinelli et al., *GEANT4: A Simulation toolkit*, *Nucl.*
 43 *Instrum. Meth.* **A506** (2003) 250–303.

- 1 [5] J. Allison et al., *Geant4 developments and applications*, *IEEE Trans. Nucl. Sci.* **53**
2 (2006) 270.
- 3 [6] Geant4 Collaboration, M. Asai et al., *Recent developments in Geant4*, *Annals Nucl.*
4 *Energy* **82** (2015) 19–28.
- 5 [7] L. Arnaudon, B. Dehning, P. Grosse-Wiesmann, R. Jacobsen, M. Jonker,
6 J. Koutchouk, J. Miles, R. Olsen, M. Placidi, R. Schmidt, et al., *Accurate*
7 *determination of the LEP beam energy by resonant depolarization*, *Zeitschrift für*
8 *Physik C Particles and Fields* **66** (1995) no. 1-2, 45–62.
- 9 [8] H. Qi, *Status and progress of TPC module and prototype R&D for CEPC*, 2017.
- 10 [9] M. Zhao, M. Ruan, H. Qi, and Y. Gao, *Feasibility study of TPC at electron positron*
11 *colliders at Z pole operation*, *Journal of Instrumentation* **12** (2017) no. 07, P07005.
12 <http://stacks.iop.org/1748-0221/12/i=07/a=P07005>.
- 13 [10] M. Ruan, D. Jeans, V. Boudry, J.-C. Brient, and H. Videau, *Fractal Dimension of*
14 *Particle Showers Measured in a Highly Granular Calorimeter*, *Phys. Rev. Lett.* **112**
15 (2014) 012001.
16 <https://link.aps.org/doi/10.1103/PhysRevLett.112.012001>.
- 17 [11] D. Yu, M. Ruan, V. Boudry, and H. Videau, *Lepton identification at Particle Flow*
18 *oriented detector for the future e^+e^- Higgs factories*, *The European Physical*
19 *Journal C* **77** (2017) no. 9, 591.
20 <https://doi.org/10.1140/epjc/s10052-017-5146-5>.
- 21 [12] H. Zhao, C. Fu, D. Yu, Z. Wang, T. Hu, and M. Ruan, *Particle flow oriented*
22 *electromagnetic calorimeter optimization for the circular electron positron collider*,
23 *JINST* **13** (2018) no. 03, P03010, [arXiv:1712.09625](https://arxiv.org/abs/1712.09625)
24 [[physics.ins-det](https://arxiv.org/abs/1712.09625)].
- 25 [13] H. Abramowicz et al., *The International Linear Collider Technical Design Report -*
26 *Volume 4: Detectors*, [arXiv:1306.6329](https://arxiv.org/abs/1306.6329) [[physics.ins-det](https://arxiv.org/abs/1306.6329)].
- 27 [14] CEPC-SPPC Study Group, *CEPC-SPPC Preliminary Conceptual Design Report. 1.*
28 *Physics and Detector*, IHEP, Beijing, China, Rep. IHEP-CEPC-DR-2015-01,
29 IHEP-TH-2015-01, IHEP-EP-2015-01 (2015) .
- 30 [15] DREAM Collaboration, R. Wigmans, *The DREAM project: Towards the ultimate in*
31 *calorimetry*, *Nucl. Instrum. Meth.* **A617** (2010) 129–133.
- 32 [16] N. Akchurin et al., *The electromagnetic performance of the RD52 fiber calorimeter*,
33 *Nucl. Instrum. Meth.* **A735** (2014) 130–144.
- 34 [17] RD52 (DREAM) Collaboration, R. Wigmans, *New results from the RD52 project*,
35 *Nucl. Instrum. Meth.* **A824** (2016) 721–725.
- 36 [18] N. Akchurin et al., *Particle identification in the longitudinally unsegmented RD52*
37 *calorimeter*, *Nucl. Instrum. Meth.* **A735** (2014) 120–129.
- 38 [19] M. Poli Lener, G. Bencivenni, R. de Olivera, G. Felici, S. Franchino, M. Gatta,
39 M. Maggi, G. Morello, and A. Sharma, *The μ -RWELL: A compact, spark protected,*
40 *single amplification-stage MPGD*, *Nucl. Instrum. Meth.* **A824** (2016) 565–568.

- 1 [20] M. Koratzinos et al., *Progress in the FCC-ee Interaction Region Magnet Design*,
2 <http://inspirehep.net/record/126211/files/wepik034.pdf> (2017) , IPAC2017.
- 3 [21] ALICE Collaboration, M. Mager, *ALPIDE, the Monolithic Active Pixel Sensor for*
4 *the ALICE ITS upgrade*, *Nucl. Instrum. Meth.* **A824** (2016) 434–438.
- 5 [22] ALICE Collaboration, G. Aglieri Rinella, *The ALPIDE pixel sensor chip for the*
6 *upgrade of the ALICE Inner Tracking System*, *Nucl. Instrum. Meth.* **A845** (2017)
7 **583–587**.
- 8 [23] KLOE Collaboration, A. Calcaterra, *The KLOE drift chamber*, *Nucl. Instrum.*
9 *Meth.* **A367** (1995) 104–107.
- 10 [24] MEG Collaboration, Y. Uchiyama, *Upgrade of MEG experiment*, PoS
11 **EPS-HEP2013** (2013) 380.
- 12 [25] A. Mazzacane, *The 4th concept detector for the ILC*, *Nucl. Instrum. Meth.* **A617**
13 **(2010) 173–176**.
- 14 [26] L. De Lorenzis, F. Grancagnolo, A. L’Erario, A. Maffezzoli, A. Miccoli, S. Rella,
15 M. Spedicato, and G. Zavarise, *Analysis and Characterization of the Mechanical*
16 *Structure for the I-Tracker of the Mu2e Experiment*, *Nucl. Phys. Proc. Suppl.*
17 **248-250** (2014) 134–136.

Draft-V1.0

CHAPTER 4

TRACKING SYSTEM

1 The CEPC physics program demands a robust and highly performant charged particle
2 tracking system. Charged particles are used directly in physics analyses; they are input
3 to determine primary and secondary vertices; and they are crucial input to particle flow
4 calorimetry.

5 The tracking system has two major components. The vertex tracker has excellent spatial
6 resolution and is optimized for vertex reconstruction. The main tracker is optimized for
7 tracking efficiency and resolution required for the CEPC physics program.

8 Section 4.1 describes the CEPC vertex tracker, the inner tracker, which can be paired
9 with one of the outer tracker options discussed in Section 4.2 (Time Projection Chamber
10 and Silicon tracker), Section 4.3 (Full Silicon Tracker) and Section 4.4 (Drift Chamber
11 Tracker).

12 4.1 Vertex tracker detector

13 The identification of heavy-flavor (b- and c-) quarks and τ leptons is essential for the
14 CEPC physics program. It requires precise determination of the track parameters of
15 charged particles in the vicinity of the interaction point (IP), permitting reconstruction
16 of the displaced decay vertices of short-lived particles. This drives the need for a vertex
17 detector with low material budget and high spatial resolution. The baseline design of the
18 CEPC vertex detector is a cylindrical barrel with six silicon pixel layers and optimized for
19 the energy regime and utilizes modern sensors.

4.1.1 Performance Requirements and Detector Challenges

As required for the precision physics program, the CEPC vertex detector is designed to achieve excellent impact parameter resolution, which in the $r\phi$ plane can be parameterized by:

$$\sigma_{r\phi} = a \oplus \frac{b}{p(\text{GeV})\sin^{3/2}\theta} \quad (4.1)$$

where $\sigma_{r\phi}$ denotes the impact parameter resolution, p the track momentum, and θ the polar track angle. The first term describes the intrinsic resolution of the vertex detector in the absence of multiple scattering and is independent of the track parameters, while the second term reflects the effects of multiple scattering. The parameters $a = 5 \mu\text{m}$ and $b = 10 \mu\text{mGeV}$ are taken as the design values for the CEPC vertex detector. The main physics performance goals can be achieved with a three concentric cylinders of double-layer pixellated vertex detector with the following characteristics:

- Single-point resolution of the first layer better than $3 \mu\text{m}$;
- Material budget below $0.15\% X_0/\text{layer}$;
- First layer located close to the beam pipe at a radius of 16 mm , with a material budget of $0.15\% X_0$ for the beam pipe;
- Detector occupancy not exceeding 1% .

The power consumption of the sensors and readout electronics should be kept below $50 \text{ mW}/\text{cm}^2$, if the detector is air cooled. The readout time of the pixel sensor needs to be shorter than $10 \mu\text{s}$, to minimize event accumulation from consecutive bunch crossings. The radiation tolerance requirements, which are critical for the innermost detector layer, are driven by the beam-related backgrounds as described in Chapter 9.

4.1.2 Baseline design

The baseline layout of the CEPC vertex detector consists of six concentric cylindrical layers of high spatial resolution silicon pixel sensor located between 16 and 60 mm from the beam line (see Figure 4.1), providing six precise space-points for charged particles traversing the detector. The main mechanical structure is called a ladder. Each ladder supports sensors on both sides; thus, there are three sets of ladders for the vertex detector. The material budget of each detector layer amounts to $\sim 0.15\% X_0$. Extensive simulation studies (see Section 4.1.3) show that this configuration with the single-point resolutions listed in Table 4.1 achieves the required impact parameter resolution.

4.1.3 Detector performance studies

The identification of b/c -quark jets (called "flavor-tagging") is essential in physics analysis where signal events with b/c -quark jets in the final state have to be separated from one another and from light-quark jets. Flavor tagging requires the precise determination of the trajectory of charged tracks embedded in the jets. For CEPC operation at the center-of-mass energy of 240 GeV , those tracks are often of low momentum, for which the multiple scattering effect dominates the tracking performance as illustrated by Eq. 4.1.

The CEPC vertex detector layout has been fully implemented in the GEANT4-based simulations framework MOKKA [1]. In addition, the LiC Detector TOY fast simulation

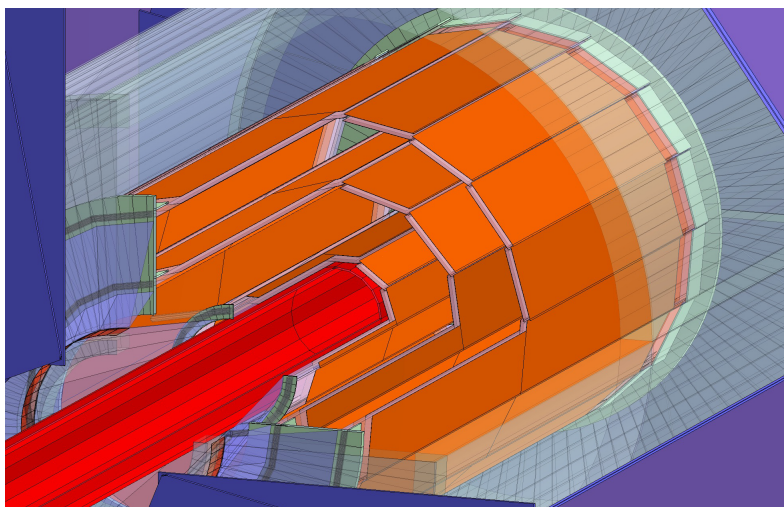

Figure 4.1: Schematic view of pixel detector. Two layers of silicon pixel sensors (in orange) are mounted on both sides of each of three ladders to provide six space points. The vertex detector surrounds the beam pipe (red).

	$R(mm)$	$ z (mm)$	$ \cos\theta $	pixel size ($\mu m \times \mu m$)	$\sigma(\mu m)$
Layer 1	16	62.5	0.97	16×16	2.8
Layer 2	18	62.5	0.96	25×25	6
Layer 3	37	125.0	0.96	25×25	4
Layer 4	39	125.0	0.95	25×25	4
Layer 5	58	125.0	0.91	25×25	4
Layer 6	60	125.0	0.90	25×25	4

Table 4.1: The baseline design parameters of CEPC vertex detector including position, pixel size and single-point resolution.

and reconstruction framework (LDT) [2] have been used for detector performance evaluation and layout optimization. The preliminary studies for optimization to evaluate the sensitivity of the results on the chosen parameters have been done, for the purpose of assessing the impact of the detector geometries and material budgets on required flavor-tagging performance. However, beam-induced background was not included at the moment.

4.1.3.1 Performance of the Baseline Configurations

The impact parameter resolution following from the single-point resolutions provided in the Table 4.1 is displayed in Figure 4.2 as a function of the particle momentum, showing that the ambitious impact parameter resolution is achievable.

4.1.3.2 Material Budget

The baseline design includes very small material budget for the beam pipe as well as for the sensor layers and their support. To assess the sensitivity of the performance on the amount of material, the material budget of the beam pipe and the vertex detector layers has been varied. The resulting transverse impact-parameter resolutions for low-momentum

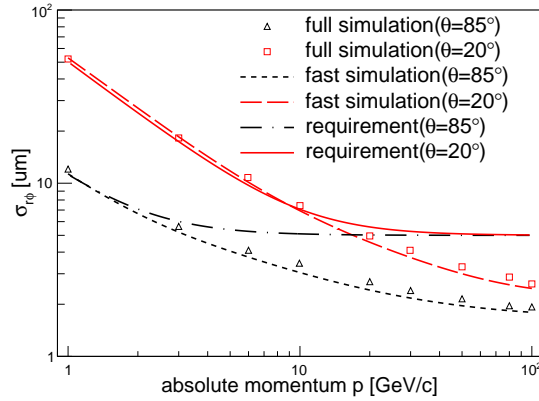

Figure 4.2: Transverse impact-parameter resolutions for single muon events as a function of momentum for two polar angles 20° and 85° . The results are shown for both fast simulation and full simulation method.

- 1 tracks are shown in Figure 4.3. When increasing the material of the detector layers by a
- 2 factor of two, the resolution degrades by approximately 20%.

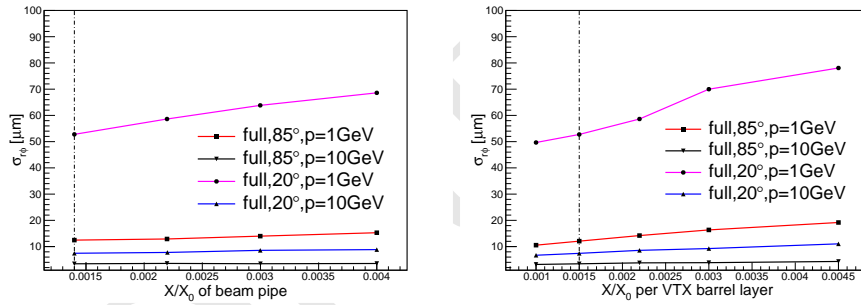

Figure 4.3: Transverse impact-parameter resolution as function of the amount of material in beam pipe (left) and in each vertex detector barrel layer (right), as obtained from the simulation. The results are shown for 1 GeV and 10 GeV muon tracks and for polar angles of $\theta=20$ degrees and of $\theta=85$ degrees. The material budget corresponding to the baseline configuration is indicated by dashed lines.

3 4.1.3.3 Dependence on Single-Point Resolution

- 4 The dependence of the transverse impact-parameter resolution on the pixel size was stud-
- 5 ied by worsening the single-point resolution of the vertex layers by 50% w.r.t. the baseline
- 6 values. The resulting impact parameter resolution for high and low momentum tracks as
- 7 function of the polar angle θ is shown in Figure 4.4. The impact parameter resolution
- 8 for track momenta of 100 GeV is found to change by approximately 50% in the barrel
- 9 region, which is expected. They are better than the target value for the high-momentum
- 10 limit of $a \sim 5 \mu\text{m}$ in both cases, as expected from the corresponding single-point resolu-
- 11 tions. For 1 GeV, where multiple-scattering effects dominate, the corresponding variation
- 12 of the transverse impact-parameter resolution is only 10% larger. The target value for the
- 13 multiple-scattering term of $b \sim 10 \mu\text{m GeV}$ is approximately reached in both cases. It
- 14 should be noted, however, that the pixel size is also constrained by the background occu-

1 pancies (see Section 4.1.4) and the ability to separate adjacent tracks in very dense jets in
 2 the presence of such backgrounds.

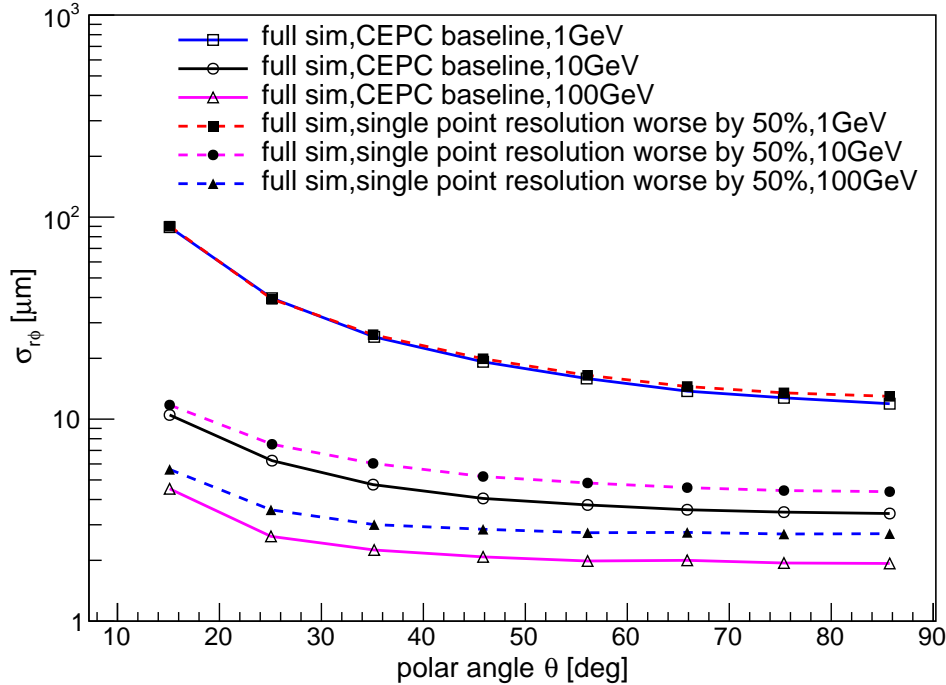

Figure 4.4: Transverse impact-parameter resolutions as function of the polar angle θ for different values of the single-point resolution of the CEPC vertex detector. Shown are the resolutions for 1 GeV, 10 GeV and 100 GeV tracks.

2

3 4.1.3.4 Distance to Beam Line

4

5 The distance of the first two vertex layers, which are supported by a single ladder, from
 6 the interaction point (IP) was varied by ± 4 mm relative to baseline geometry of the CEPC
 7 vertex detector. **When we move the first layer from 16 to 12 mm, does it still clear the
 8 beam pipe? In any case, what do we do with beam pipe radius in this study? It is the
 9 last scattering surface when extrapolating back and has impact on the answer. I think we
 10 need to clarify what has been studied.** Figure 4.5 shows the resulting transverse impact
 11 parameter resolution at $\theta=85$ degrees as function of the momentum and for different radial
 12 distances of the innermost barrel vertex layer from the IP. For low momentum tracks, the
 13 transverse impact-parameter resolution is proportional to the inner radius, as expected

14

14 4.1.4 Beam-induced Background in the Vertex Detector

15

16 Pair-production and off-energy beam particles are expected to be the dominating source
 17 of detector backgrounds originating from the interaction region. These processes have
 18 been studied with detailed Monte Carlo simulation in Chapter 9. For the first vertex detec-
 19 tor layer, the maximum annual values of the Total Ionising Dose (TID) and Non-Ionising
 20 Energy Loss (NIEL) are estimated to be 3.4 MRad and 6.2×10^{12} 1 MeV n_{eq}/cm^2 per year,
 respectively, with a safety factor of 10 included (see Table 9.4 in Chapter 9). This hap-

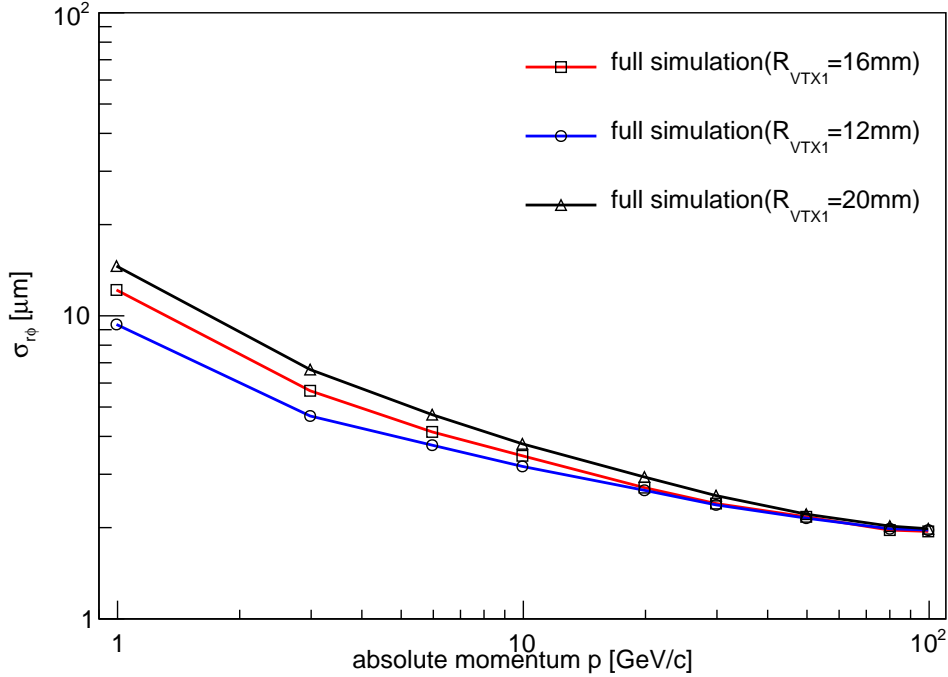

Figure 4.5: Transverse impact-parameter resolution at $\theta=85$ degrees as function of the momentum for different values of inner most layer radius R_{VTX1} . The red curve indicates the baseline configuration of $R_{VTX1}=16$ mm.

- 1 pens when the machine is operating at the Z-pole energy, and imposes radiation tolerance
2 requirements on the silicon pixel sensor and associated readout electronics.

	H(240)	W(160)	Z(91)
Hit density (hits \cdot cm $^{-2}$ \cdot BX $^{-1}$)	2.4	2.3	0.25
Bunching spacing (μ s)	0.68	0.21	0.025
Occupancy (%)	0.08	0.25	0.23

Table 4.2: Occupancies of the first vertex detector layer at different machine operation energies: 240 GeV for ZH production, 160 GeV near W-pair threshold and 91 GeV for Z-pole.

- 3 The beam-induced background will have impacts on vertex detector occupancy, which
4 is critical for the innermost detector layer. Table 4.2 shows the expected hit density and
5 occupancies of the first vertex detector layer at different machine operation energies. The
6 result of occupancies depends on assumptions of detector readout time and average cluster
7 size. Here we assume 10 μ s of readout time for the silicon pixel sensor and an average
8 cluster size of 9 pixels per hit, where a pixel is taken to be 16×16 μ m 2 . The resulting
9 maximal occupancy at each machine operation mode is below 1%.

10 4.1.5 Sensor Technology Options

- 11 Significant progress has been made since the first silicon pixel detector was first used
12 in high-energy physics experiments, and considerable R&D efforts have taken place to

1 develop pixel sensors for vertex tracking at future particle physics experiments [3], driven
 2 by track density, single-point resolution and radiation level.

3 As outlined in Section 4.1.1, the detector challenges for the CEPC include high impact-
 4 parameter resolution, low material budget, low occupancy and sufficient radiation tol-
 5 erance (mild comparing to LHC but not necessarily easy to achieve). To fulfill these
 6 requirements at system level, sensor technologies which achieve fine pitch, low power
 7 and fast readout must be selected. These considerations present unique challenges to the
 8 CEPC vertex detector. CEPC has a bunch spacing of $0.68 \mu\text{s}$, and power pulsing cannot
 9 be utilized to reduce average power as is planned at the ILC. Experiments such as the
 10 STAR[4], BELLEII[5] and ALICE upgrade[6] readout continuously as the CEPC. How-
 11 ever, they have less stringent requirements in terms of impact-parameter resolution and
 12 material budget.

13 The monolithic pixel sensor has the potential to satisfy the low-material and high-
 14 resolution requirements of the CEPC vertex detector. This technology has been devel-
 15 oping fast. The 1st generation MAPS-based vertex detector for the STAR HFT upgrade
 16 [4, 7] just completed 3-year physics run successfully, while the new generation HR CMOS
 17 Pixel Sensor for ALICE-ITS upgrade [6] is in mass production. In the previous $0.35 \mu\text{m}$
 18 double-well process, only N-MOS transistors can be used in the pixel design. This con-
 19 straint is removed in the new $0.18 \mu\text{m}$ quadruple-well process. Both N- and P-MOS
 20 transistors could be used in the pixel design. Combining with the smaller feature size, it
 21 becomes a very appealing technology. A good start point for the CEPC vertex would be
 22 the ALPIDE design [8], which is developed for the aforementioned ALICE-ITS upgrade
 23 and has achieved performances very close to the requirements of the CEPC. Further R&Ds
 24 are needed to shrink the pixel pitch to $16 \mu\text{m}$ (binary readout) in order to accomplish the
 25 required $2.8 \mu\text{m}$ single-point resolution. Another monolithic option is the Silicon On In-
 26 sulator (SOI) pixel sensor. After more than 10 years of evolution, SOI has entered a new
 27 stage of maturity. Fundamental issues, including the transistor shielding [9] and the TID
 28 tolerance [10], have been addressed and wafer thinning [11] has been demonstrated. In the
 29 meanwhile, R&Ds for the ILC and CLIC [12, 13] are exploring time stamping and analog
 30 readout schemes. The SOI has a unique feature of a fully-depleted substrate as the active
 31 silicon. And its $0.2 \mu\text{m}$ CMOS process provides the necessary density of transistors as the
 32 $0.18 \mu\text{m}$ CMOS in HR CMOS does. Therefore it is envisaged that the readout design for
 33 the CEPC vertex may be adapted for both processes and to exploit each ones potentials.

34 Depleted P-channel Field Effect Transistor (DEPFET) is referred to as semi-monolithic
 35 because the first amplification stage can be integrated into the pixel combined with subse-
 36 quent processing circuit in separate readout ASICs. The BELLE II is anticipating its full
 37 detector operation with a DEPFET-based vertex detector [5] installed at the end of 2018.
 38 It is very helpful to have the readout ASICs, as the major heat sources, located outside
 39 the detector acceptance area, while keeping the sensors exceptionally low power and low
 40 material. The challenge is to periodically sample the modulated current over a large pixel
 41 array within required intervals, $20 \mu\text{s}/\text{frame}$ or even less.

42 Hybrid pixel has been used at hadron colliders for the past decades, and now CLIC
 43 R&D is pushing for $50 \mu\text{m}$ thinned sensors, bump-bonded on $25 \mu\text{m}$ pitch to $50 \mu\text{m}$
 44 thinned ASICs [14]. The hybrid approach evolves constantly and profits from industrial
 45 technology developments. Apart from the Very Deep Sub-Micron (VDSM) ASIC tech-
 46 nology that enables complex functionalities and superior performances, a close watch on

1 industrial developments of the vertical and lateral inter-connection technologies will also
2 be very helpful to meet the material budget.

3 **4.1.6 Mechanics and Integration**

4 The design of the vertex detector is conceived as a barrel structure with three concentric
5 cylinders of double-sided layers. Each double-sided layer is equipped with pixel sensors
6 on both sides, and has a common support frame. In the azimuthal direction, each layer is
7 segmented in elements called ladders. The ladder, which extends over the whole length of
8 the layer, is the basic building block of the detector. It contains all structural and functional
9 components, such as chips, flex cable, support frame and cold plate if it is necessary. Pixel
10 chips in a row are connected to flex cable by wire bonding or other bonding techniques,
11 and then glued to the support frame, which is composed of low- Z materials, such as
12 carbon fiber and silicon carbide, providing stable mechanical support. The other side of
13 the support frame is equipped with another layer of pixel sensors.

14 The design of the ladders should take into account the specifications of the vertex de-
15 tector. In order to reduce a small multiple Coulomb scattering contribution to the charged-
16 track vertex resolution and control deformations from gravity and cooling forces for the
17 sensor position stability, the ladder mechanical support must fulfill stringent requirements
18 in terms of minimum material budget and highest stiffness. Ladder designs similar to
19 the STAR pixel detector, the ALICE ITS, the BELLE II PXD, and the ILD double-sided
20 ladder are under consideration.

21 The ladder mechanical support is inherently linked to the layout of the cooling system
22 that will be adopted to remove the heat dissipated by the pixel sensors since the cooling
23 system is integrated in the mechanical structure. The cooling system of the CEPC vertex
24 detector must balance the conflicting demands of efficient heat dissipation with a minimal
25 material budget. Therefore a suitable, high thermal conductivity and low material budget,
26 cold plate coupled with pixel sensors should be implemented in the ladder design. There
27 are two main types of cooling methods in particle physics experiments, air cooling and
28 active cooling. Table 4.3 gives a list of cooling methods and the corresponding material
29 of each layer of the aforementioned experiments. The upgrade of ALICE ITS [6] adopts
30 water cooling with respect to a chips power dissipation value of 300 mW/cm^2 . Poly-
31 imide cooling pipes fully filled with water are embedded in the cold plate. STAR-PXL
32 [15] uses air cooling according to its chips power consumption of 170 mW/cm^2 . For
33 ILD [16] vertex system, two different cooling options are considered, depending on the
34 sensor technology. The sensors and SWITCHER chips of BELLE II PXD [17] require air
35 cooling, while active cooling will be used for readout chips on each end of the detector,
36 which is out of the sensitive region of the detector. For the CEPC vertex detector, the
37 suitable cooling method will be determined according to the sensor option and the power
38 consumption.

39 Simulation and module prototype studies will be carried out to find suitable designs that
40 can meet requirements of stability, cooling and the performance of the vertex detector. For
41 the design of the whole mechanical structure of the vertex detector, some criteria must be
42 taken into account. Firstly, minimum material has to be used in the sensitive region to
43 reduce multiple Coulomb scattering. Secondly, to ensure high accuracy in the relative
44 position of the detector sensors and provide an accurate position of the detector with
45 respect to the central tracker of TPC and the beam pipe, a mechanical connector or locating

Vertex detector	Power dissipation	Cooling method	Material budget requirement/layer
Alice ITS	300 mW/cm^2	water	0.3%
STAR PXL	170 mW/cm^2	air	0.39%
ILD vertex	$<120 \text{ mW/cm}^2$ (CPS and DEPFET)	air or N_2	0.15%
	35W inside cryostat (FPCCD)	two-phase CO_2	
BELLE-II PXD	20W for sensor and SWITCHER	Air	0.2%
	180W on each end	CO_2	

Table 4.3: Cooling method of the vertex detector in each experiment.

1 pin at each end of the ladder should be considered to allow the fixation and alignment
 2 of the ladder itself on the end rings. Thirdly, the cooling system should be arranged
 3 reasonably to ensure stable heat dissipation. Lastly, to reduce the dead region caused by
 4 the boundary of each ladder, neighboring ladders should be partially superimposed.

5 In addition, the main mechanical support structures of the vertex should also meet the
 6 requirements of the integration with the other detectors, such as time-projection chamber
 7 (TPC) and forward tracking disks.

8 4.1.7 Critical R&D

9 The inner most layers have to fulfill the most demanding requirements imposed by the
 10 physics program. In addition, the system is bounded by stringent running constraints. The
 11 technology options in Section 4.1.5 are able to meet each individual requirement, includ-
 12 ing single-point resolution, low material budget, fast readout, low power consumption and
 13 radiation tolerance, but R&D is needed to select the specific design which can achieve the
 14 combination of all these criteria. Due to the limited manpower and availability of process,
 15 presently R&D efforts have been put into CMOS and SOI pixel sensor development to
 16 address the challenges concerning single-point resolution and low power consumption.
 17 Further developments are foreseen to follow in the future, including enhancement of den-
 18 sity, radiation hardness and ultra-light module assembly.

19 The current R&D activities have access to two advanced processes. The TowerJazz
 20 $0.18 \mu\text{m}$ quadruple-well process enables the full CMOS pixel circuit, while Lapis $0.2 \mu\text{m}$
 21 double-SOI process has properly solved the crosstalk between sensor and digital part, and
 22 improved TID tolerance significantly.

23 In order to exploit the potential of these new developments, two design teams have
 24 started chip designs using HR CMOS and SOI technologies, respectively. Two designs
 25 have been submitted to the TowerJazz foundry. The first one uses simple three transistor
 26 (3T) analog amplification circuit to carry out the optimization of sensing diode and eval-
 27 uate the influence of radiation damage [18]. The second one implements a well-proved
 28 rolling shutter readout as well as an innovative data-driven readout [19, 20]. Another two

1 designs that adopt the SOI technology have also been submitted [21]. With the amplifier
 2 and discriminator integrated into each pixel, the pixel size has been shrunk to $16\ \mu\text{m}$ pitch.
 3 The chip has been thinned to $75\ \mu\text{m}$ successfully and an infrared laser test has shown that
 4 a single-point resolution of $2.8\ \mu\text{m}$ is achievable with that pitch [11]. All the designs for
 5 current R&D are in line with the same principle of in-pixel discrimination even though
 6 each one has its own implementation. An in-pixel discriminator can reduce analog current
 7 therefore lead to reduced power consumption.

8 Enhancements of the TowerJazz $0.18\ \mu\text{m}$ process or Lapis $0.2\ \mu\text{m}$ process are possible
 9 by migrating to a smaller feature size, $0.13\ \mu\text{m}$ for example, or combining with a micro-
 10 bump 3D integration process. The latter is able to attach a second layer of pixel circuit
 11 on top of the existing layer of the sensing diode and front-end circuit. The upper tier can
 12 be the fully digital part that implements data-driven readout architecture, while the lower
 13 tier can be HR CMOS or SOI pixel matrix. A promising result has been demonstrated by
 14 the successful formation of $2.5\ \mu\text{m}$ Au cone bump with NpD (Nano-particle deposition)
 15 technique [22]. However, the throughput needs further improvement and the thinning of
 16 sensors has to be compatible with micro-bump 3D integration.

17 The TowerJazz process is expected to be sufficiently radiation hard for the expected
 18 TID. An N-type plain implant has recently been added to improve the charge collection
 19 efficiency [23], which therefore will benefit the non-ionization radiation damage. In terms
 20 of the SOI process, the weak point is the BOX layer of SiO_2 . Although the TID tolerance
 21 of the SOI process has been improved dramatically by the introduction of Double-SOI and
 22 the optimization of transistor doping recipe (LDD, lightly doped drain) [10], SOI needs
 23 carefully study on the irradiation of large scale chips and of low power designs.

24 Sensor thinning and ultra-low material construction of modules are subject to the con-
 25 straint of $0.15\% X_0/\text{layer}$. HR CMOS wafer thinned to $50\ \mu\text{m}$ is routine in semiconductor
 26 industry nowadays. SOI wafers thinned to $75\ \mu\text{m}$ with backside implant have also been
 27 demonstrated by current R&D. However, low material detector modules need to integrate
 28 mechanical support, power and signal connections, and have sufficient stiffness to avoid
 29 vibration.

30 A pixel detector prototype will be built with full-size pixel sensors to develop and test
 31 some of these critical aspects, including the mechanical design of low-mass support struc-
 32 tures, cooling, fast readout and radiation tolerance.

33 4.1.8 Summary

34 The basic concept of the CEPC Vertex detector, including the detector layout, the material
 35 budget per layer, and the pixel sensors specifications required by the impact parameter
 36 resolution are implemented in the baseline detector simulation. This is an essential re-
 37 quirement for the detailed mechanical design. Small pixel sensor prototypes that can
 38 satisfy some of the CEPC requirements have already been produced.

39 It will be crucial to continue the pixel sensor R&D program and develop pixel sensors
 40 with radiation tolerance, lower power consumption and fast readout electronics because
 41 of continuous colliding mode and strong beam-related background. Detailed designs for
 42 low-mass mechanical supports, cooling, cabling, and power conversion are also necessary.
 43 Most of these issues will be addressed by R&D for the CEPC and by exploring synergies
 44 with experiments which have similar requirements.

4.2 Time Projection Chamber and Silicon tracker

The Time Projection Chamber (TPC) is one of the options being considered for the CEPC outer tracker. The high density of space points provides unparalleled pattern recognition capability. The TPC is complemented by an envelope of silicon detectors to improve its momentum resolution. The silicon detectors are also useful for monitoring possible field distortions in the TPC and for alignment purposes.

4.2.1 Time Projection Chamber

Time Projection Chambers have been extensively studied and used in different fields, especially in particle physics experiments such as STAR [24] and ALICE [25]. The technology directly provides three-dimensional space points; the gaseous detector volume gives a low material budget; and the high density of such space points enables excellent pattern recognition capability. However, care must be taken to address space charge distortion resulting from the accumulation of positive ions in the drift volume [26]. This issue is especially important in high rate conditions.

There have been extensive R&D on readout modules to optimize position resolution and to control ion feedback. These studies will continue for the next few years in order to understand and resolve several critical technology challenges.

4.2.1.1 CEPC Time Projection Chamber

The TPC consists of a field cage, which is made with advanced composite materials, and two readout end-plates that are self-contained including the gas amplification, readout electronics, supply voltage, and cooling. The CEPC TPC consists of a cylindrical drift volume with an inner radius of 0.3 m and an outer radius of 1.8 m, and it has a full length of 6 m. The central cathode plane is held at a potential of 50 kV, and the two anodes at the two endplates are at ground potential. The cylindrical walls of the volume form the field cage, which ensures a highly homogeneous electrical field between the electrodes of 300 V/cm. The drift volume is filled with Ar/CF₄/iC₄H₁₀ in the ratio of 95/3/2. Ionization electrons released by charged particle tracks drift along the electric field to the anodes where they are amplified in an electron avalanche and readout using a micro-pattern gaseous detector (MPGD).

The CEPC TPC is operated at atmospheric pressure resulting in a material budget of less than 1% X_0 in the central region. The 3-Tesla solenoidal magnetic field suppresses transverse diffusion and improves position resolution. It also curls up low-momentum tracks resulting in higher occupancy near the beam line. The readout modules are attached to the end-plates from the inside to minimise the dead area between adjacent readout modules. Thus, a particular mounting technique is required to enable rotation and tilting of the readout modules during installation.

The chamber's cylindrical inner and outer walls serve multiple functions. They hold the field forming strips, which are attached to a divider chain of non-magnetic resistors. Since the central cathode will be held at approximately 50 kV, the walls must withstand this enormous potential. The field cage will be designed to maintain the electric field uniform over the whole active TPC volume. Advanced composite material will be used for the cylindrical walls because of its low mass.

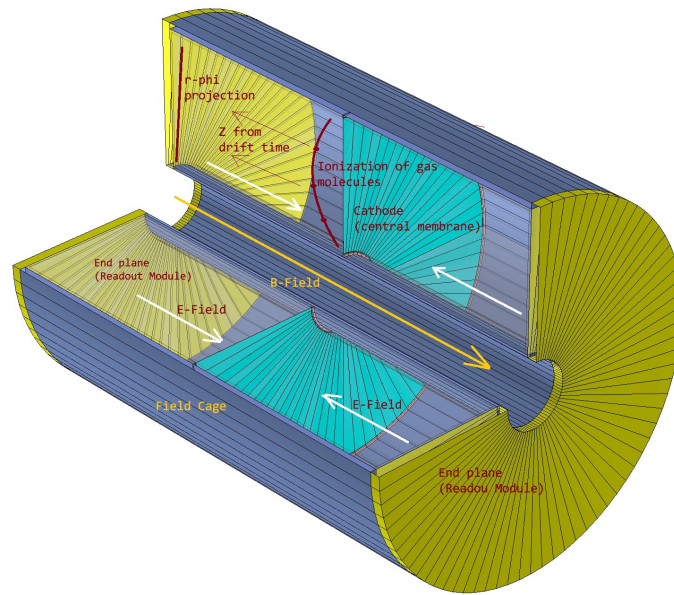

Figure 4.6: Sketch of the TPC detector structure.

1 The MPGD detector on each endplate is divided into many independent readout mod-
 2 ules to facilitate construction and maintenance. The modules are mounted closely together
 3 on the endplate to provide nearly full coverage. Power cables, electronic connectors, cool-
 4 ing pipes, PCB boards and support brackets wall are also mounted on the end-plate. The
 5 end-plate needs to be constructed from a lightweight material in order not to compromise
 6 the jet energy resolution in the forward region but also should be still sufficiently rigid to
 7 maintain stable positioning of the detector modules with a position accuracy better than
 8 $50 \mu\text{m}$. The endcap structure has a thickness of $8\%X_0$, 7% of which originate from the
 9 material for the readout planes, front-end electronics and cooling. Adding power cables
 10 and connectors, the total thickness increases from $8\%X_0$ up to $10\%X_0$.

11 The CEPC TPC provides 220 space points per track with a single-point resolution in
 12 $r - \phi$ of $100\mu\text{m}$. In addition to position information, the TPC measures the energy loss
 13 on each readout pad. This can be combined with the measurement of momentum in the
 14 magnetic field to provide particle identification.

15 4.2.1.2 Baseline design and technology challenges

16 The readout structure is designed to be modular to facilitate construction and maintenance.
 17 Each module will consist of gas amplification system, readout plane and the associated
 18 front-end electronics. An MPGD-based gas amplification system will be necessary to
 19 achieve the required performance, and the charge from the amplification system will be
 20 collected on the readout board. The readout module will also have to provide all necessary
 21 power and cooling. Each module will be approximately 170 mm in width and 200 mm in
 22 height.

23 Figure 4.7 shows the design of the mechanical support for the mounting of the readout
 24 modules on the inside of the TPC endwall developed by the LC-TPC international collab-
 25 oration group *R&D*. Readout modules are inserted at an angle through openings in the
 26 endwall (white in the figure) into the drift volume. They are then rotated to the proper
 27 orientation, pulled back against the mounting frame (yellow in the figure), and bolted into

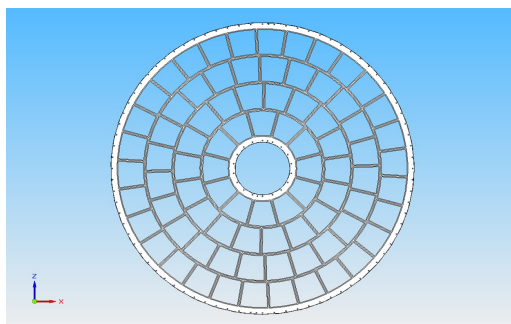

Figure 4.7: Diagram of mechanical support for the mounting of the readout modules on the inside of the TPC endwall. The module assembled in the every module support area, the example size of the module is $170\text{mm} \times 210\text{mm}$

1 place from the outside. This approach allows the active areas of adjacent readout modules
2 to be very close to one another and therefore minimizes dead space between them.

3 **Gas amplification detector module**

4 The required physics performance can be achieved with any amplification technology
5 with gain in the range of $10^3 - 10^4$ combined with a spatial granularity of approximately
6 1mm^2 . Gas Electron Multiplier (GEM) [27] and Micro-Mesh Gaseous Structure detector
7 (MicroMEGAS) [28] of the MPGD family of detectors [29] are both viable technologies
8 for the large-area application in the CEPC TPC readout module. They can generate the
9 very high fields necessary for gas amplification with modest voltages (300-400V) across
10 $50 - 100\mu\text{m}$ structures. In the case of GEM, two or three will be stacked together to
11 achieve sufficient charge amplification while MicroMEGAS have enough amplification in
12 a single stage.

13 Micro-pattern gaseous devices such as GEM and MicroMEGAS provide:

- 14 1. High gain
- 15 2. High rate capability: MPGDs provide a rate capability over $10^5\text{Hz}/\text{mm}^2$ without
16 discharges that can damage electronics.
- 17 3. Intrinsic ion feedback suppression: Most of the ions produced in the amplification
18 region will be neutralised on the mesh or GEM foil and do not go back to the drift
19 volume.
- 20 4. A direct electron signal, which gives good time resolution ($< 100\text{ps}$) and spatial
21 resolution ($100\mu\text{m}$).
- 22 5. Small $E \times B$ effects.

23 **Optimization readout strip size**

24 Signals are read out in two orthogonal sets of strips. The readout strips in the X direction
25 are $193\mu\text{m}$ wide with a pitch of $752\mu\text{m}$. The readout strips in the Y direction are $356\mu\text{m}$
26 wide with a pitch of $457\mu\text{m}$. The difference in strip widths is to improve signal sharing
27 between adjacent strips. Strips are approximately 6 mm long, and each strip is connected
28 to one electronic channel to process the signal. Each readout unit contains 267 channels
29 for the X direction and 437 channels for the Y direction.

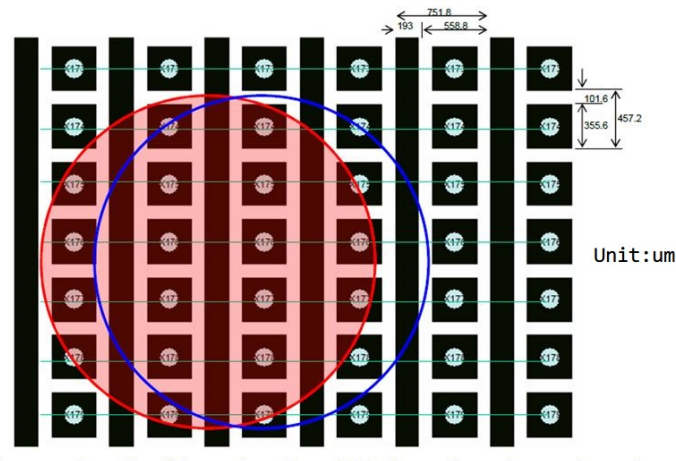

Figure 4.8: The profile of an electron cluster in Triple GEMs. Vertical black lines are the strips in the X direction with a pitch of $752 \mu\text{m}$. The light blue horizontal lines connect electrodes to form strips in the Y direction. The red and blue circles are two representative clusters.

1 Figure 4.8 is a typical layout of the X and Y readout strips, and two representative
 2 electron clusters are also superimposed. Each X-Y strip crossing has an area about 1
 3 mm^2 . Thus each cluster spans a large number of such crossings, allowing the use of the
 4 Center-of-Gravity method to reach a position resolution finer than the strip pitches.

5 **Operation gas for the long drift**

6 The choice of chamber gas strongly affects the properties and eventually the perfor-
 7 mance of a TPC. Desirable characteristics are:

- 8 1. High drift velocity (to avoid accumulation of too many events inside the chamber)
- 9 2. Low electron capture probability (to preserve signal size)
- 10 3. Low transverse and longitudinal diffusion coefficients (to prevent deterioration of the
 11 spatial resolution)
- 12 4. Large specific energy loss dE/dx (to improve particle identification)
- 13 5. Stability against electrical breakthroughs (to allow reliable operation of the ampli-
 14 fication device)
- 15 6. Nonhazardous chemical properties (to address safety concerns like inflammability and
 16 damages to the hardware)

17 Due to the long drift distance of ~ 3.0 m and the fact that ions are more massive and
 18 much slower than electrons, a large number of ions can accumulate in the chamber. This
 19 effect can lead to electric field distortions and should be minimized. To decrease this
 20 effect, the structure of the readout chambers is generally designed to avoid ions from es-
 21 caping into the gas volume. A gas with a large drift velocity is also chosen in experiments
 22 with large interaction rate.

23 In a given working gas, the drift velocity of the electron is a function of E/P where
 24 E denotes the electric field and P the gas pressure. Figure 4.9 shows the drift velocity
 25 obtained in two different gas mixtures. The mixture of $\text{Ar}/\text{CF}_4/\text{iC}_4\text{H}_{10}$ (95%/3%/2%)
 26 is widely used in a number of experiments and is the default for CEPC. At atmospheric

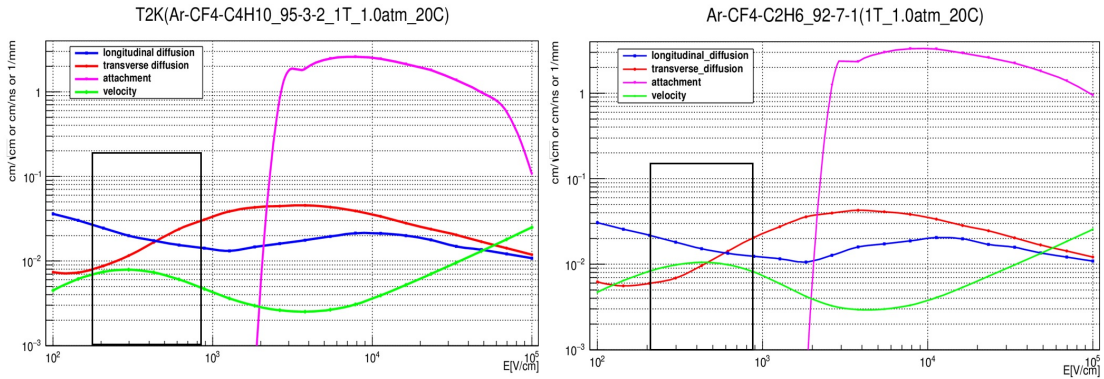

Figure 4.9: The drift velocity in different gas mixture and the faster possible mixture gas comparing T2K gas. (Green line: Drift velocity, Red line: Transverse diffusion coefficient, Blue line: Longitudinal diffusion coefficient, Purple line: Attachment coefficient, Black rectangle: Possible operation range)

1 pressure, this mixture has a saturated drift velocity of approximately $8 \text{ cm}/\mu\text{s}$ in a drift field
 2 of $\sim 300 \text{ V/cm}$. In addition, the gas has a transverse diffusion coefficient of $30 \mu\text{m}/\sqrt{\text{cm}}$.
 3 The bunch spacing at the CEPC in Higgs factory operation is $0.68 \mu\text{s}$, and 25 ns in Z
 4 factory operation. Since the ion backflow problem scales with the number of collisions
 5 within the maximum drift time, a working gas with a higher saturated drift velocity would
 6 be beneficial and should be considered. The mixture $\text{Ar}/\text{CF}_4/\text{C}_2\text{H}_6$ ($92\%/7\%/1\%$) is a
 7 candidate: its saturated drift velocity is roughly 20% higher than the default gas mixture
 8 and the diffusion coefficients are lower. Further R&D is needed to confirm that its other
 9 properties are compatible with CEPC needs.

10 Low power consumption electronics readout

11 Small readout pads of a few square millimeters (e.g. $1 \text{ mm} \times 6 \text{ mm}$, there are 3 pads in
 12 the electron cluster size 4.8) are needed to achieve high spatial and momentum resolution
 13 in TPC, demanding about 1 million channels of readout electronics per endcap. The total
 14 power consumption of the front-end electronics is limited by the cooling system to be
 15 several kilo-watts in practice. The architecture of the TPC readout electronics is shown
 16 in Figure 4.10, selected from a broad range of survey on current electronics installed or
 17 under development during past decades, including ALTRO/S-ALTRO and more recently
 18 SAMPA for ALICE, AFTER/GET for T2K and Timepix for ILC. It consists of the front-
 19 end electronics on the detector panel and the data acquisition system several meters away
 from the detector.

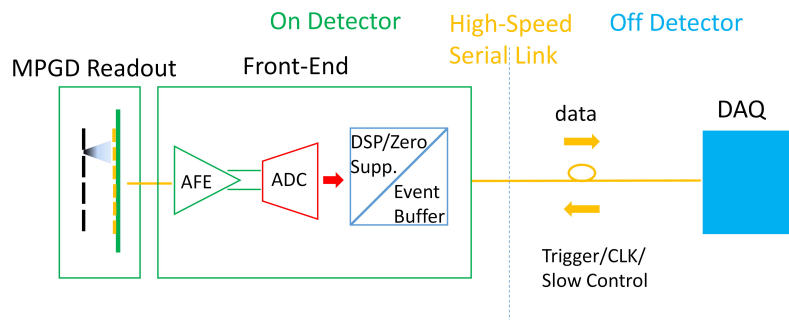

Figure 4.10: The architecture of the TPC readout electronics.

Total number of channels		1 million per endcap
AFE (Analog Front-End)	ENC (Equivalent Noise Charge)	500e @ 10pF input capacitance
	Gain	$10mV/fC$
	Shaper	CR-RC
	Peaking time	100ns
ADC	Sampling rate	≥ 20 MSPS
	Resolution	10 bit
Power consumption		$\leq 5mW$ per channel
Output data bandwidth		300MB/s-500MB/s
Channel number		32
Process		TSMC 65nm LP

Table 4.4: The Key Specifications of the Front-End ASIC for TPC.

1 The waveform sampling front end is preferable, including a preamplifier and a shaper
2 as the analog front-end (AFE), a waveform sampling ADC operating at ≥ 20 MSPS,
3 a dedicated digital signal processing (DSP) and zero-suppression unit and a de-randomize
4 event buffer for each channel. To satisfy the stringent requirements on the integration and
5 the power consumption, a front-end ASIC will be developed in advanced 65nm CMOS
6 process. The key specifications of the front-end ASIC are summarized in Table 4.4 as
7 follow.

8 CMOS scales down in favor of digital circuits regarding power and density. The power
9 consumption of the DSP circuits reported in Ref. [27] was $4mW/ch$ in a 130nm process
10 and could be reduced by a factor of at least two by migrating the same design to 65nm.
11 However, this is not the equivalent of the analog circuits. The design strategy for the
12 front-end ASIC is to keep the analog part as simple as possible. The block diagram of the
13 analog front-end and the Successive Approximation Register (SAR) ADC are shown in
14 Figure 4.11 and Figure 4.12, respectively. The CR-RC shaper and the SAR ADC instead
15 of pipeline ADC will be used for their simplicity in analog circuits and hence the higher
16 power efficiency, hence the development of the low power front-end ASIC is essential.

17 Dedicated digital filters will be applied to the continuously digitized input signals to
18 suppress the pedestal perturbations caused by the non-ideal effects such as temperature
19 variation and environmental disturbance. Then the data will be compressed by only stor-
20 ing the data packets above a programmable threshold with a specified number of pre- and
21 post-samples. A data head will be added to each packet with its timestamp and other in-
22 formation for reconstruction afterward. The buffered data are readout through high-speed
23 serial links to the DAQ system. The front-end electronics can support both external trigger
24 and self-trigger mode.

25 Even with the state of the art technology, the TPC front-end electronics on the endplate
26 needs cooling system to keep the temperature stable. Two-phase CO_2 cooling[7] is a
27 well-developed technology and can be used as a baseline solution to bring out the heat
28 generated by the front-end electronics and to keep the temperature of the TPC chamber

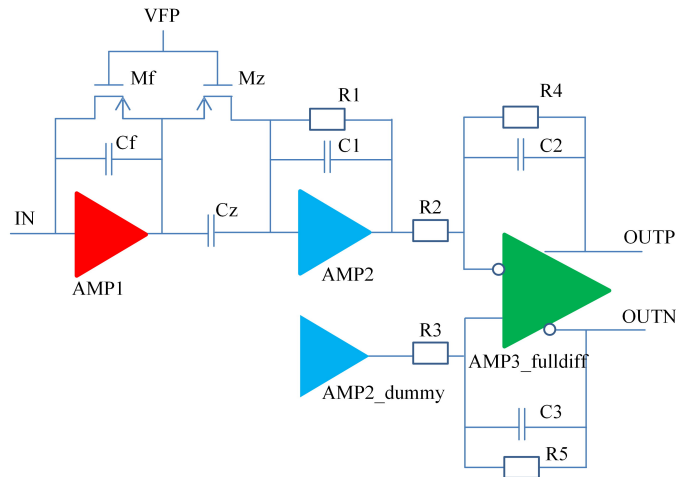

Figure 4.11: The block diagram of the analog front-end.(AMP1: core amplifier for the preamplifier; AMP2/AMP_dummy: first stage shaper amplifier; AMP3_fulldiff: fully differential amplifier for the second stage shaper; VFP: bias voltage to adjust feedback resistor for the preamplifier)

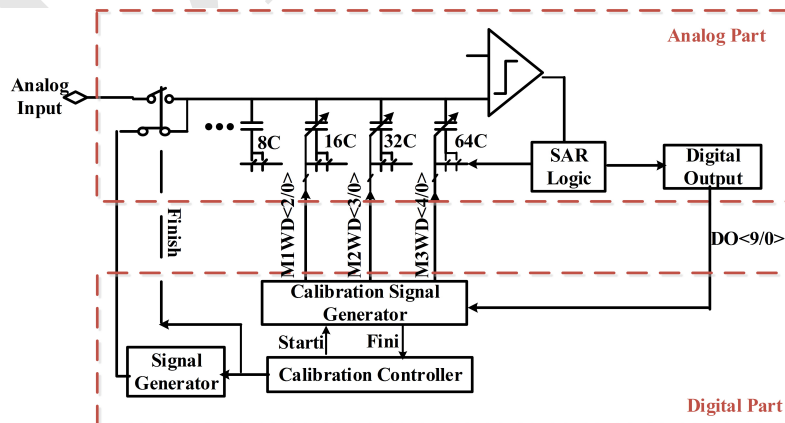

Figure 4.12: The block diagram of the SAR(Successive Approximation Register)-ADC.

1 stable at 20°C. Micro-channel CO_2 cooling has lower mass and may be studied further
 2 and can be an alternative technique to copper pipes [8].

3 The TPC readout electronics are meters away from the collision point, and the radiation
 4 dose is rather low ($< 1krad$) at CEPC, which allows us to use standard, radiation soft
 5 technologies. On the other hand, energetic particles can always produce instantaneous
 6 failure (SEU or SEL) from time to time. Hence radiation sophisticated design needs to be
 7 considered that the overall system performance will not be affected or even irreversibly
 8 damaged by the rare events.

9 Critical technology challenges of TPC detector

10 It will be challenging to design and manufacture the support structure with a relatively
 11 light material, and at the same time very rigid. It is required to maintain accuracy, robust-
 12 ness in all directions, and stability over long time periods. As the field cage is not strong
 13 enough due to the limited material budget, the end-plates become the only choice, where
 14 the support structure connects to. In the current stage of design, how the TPC end-plate
 15 should be supported is not fixed yet. A promising solution is to suspend from the solenoid,
 16 in which a number of spokes run radially along the faces of the calorimeter to the TPC
 17 end-plates. A bearing is not the most challenging issue.

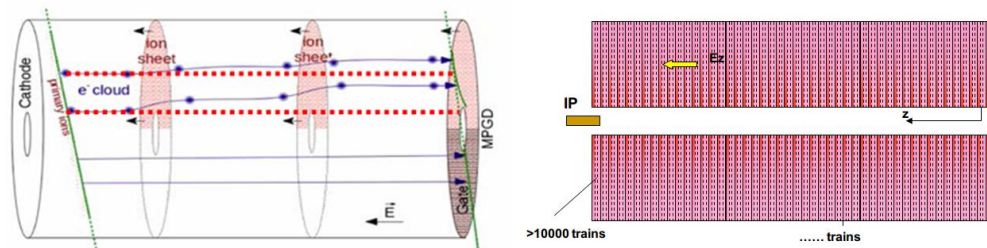

Figure 4.13: The diagram of distortion and ion disks in CEPC. (Left: Red dots line is the original track of the electrons without the distortion, blue line is the measurement track of the electrons with the distortion in the several ions disk cloud. Right: The profile of the ions disks under the beam structure in the circular machine.)

18 Ions in the drift volume of the TPC move towards the cathode at a much lower velocity
 19 than electrons, and they can accumulate in this volume to build up a significant space
 20 charge in the form of 'ion discs' that distort the trajectory of electrons moving towards the
 21 anodes. In the CEPC TPC, the majority of ions inside the drift volume are created in the
 22 amplification region and backflow to the drift region. It is therefore important to suppress
 23 this ion backflow in order to minimize the deteriorating influence on spatial resolution.

24 Figure 4.13 shows a diagram of the distortion due to ion backflow and ion disks in
 25 CEPC. An often used method of backflow suppression is a so-called gating grid; however,
 26 it is not applicable here because the bunch spacing of $0.62\mu s$ is short compared with the
 27 maximum electron drift time. Another promising option is to exploit the 'built-in' ion
 28 backflow suppression of GEMs or MicroMEGAS. In next section, the R&D study of the
 29 hybrid detector module has been promoted to control ions continuously, and the updated
 30 results will be described.

4.2.1.3 Simulation and estimation for the key issues

Occupancy requirement of Higgs and Z pole run

Occupancy at 240 GeV center-of-mass energy has been estimated at WZ and Z pole and the CEPC accelerator design instantaneous luminosity of $3 \times 10^{34} \text{cm}^2 \text{s}^{-1}$. Occupancy when operating at the Z-pole has been estimated based on a cross-section of 32nb for $Z \rightarrow q\bar{q}$ and a luminosity of $16 \times 10^{34} \text{cm}^2 \text{s}^{-1}$.

Using an sample of 9 thousand fully simulated $Z \rightarrow q\bar{q}$ events at center of mass energy of 91.2 GeV[30], we studied the voxel occupancy and the local charge density of the CEPC TPC at Z pole operation for future circular electron positron colliders, with the value of an instant luminosity from $2 \times 10^{34} \text{cm}^2 \text{s}^{-1}$ to $2 \times 10^{36} \text{cm}^2 \text{s}^{-1}$.

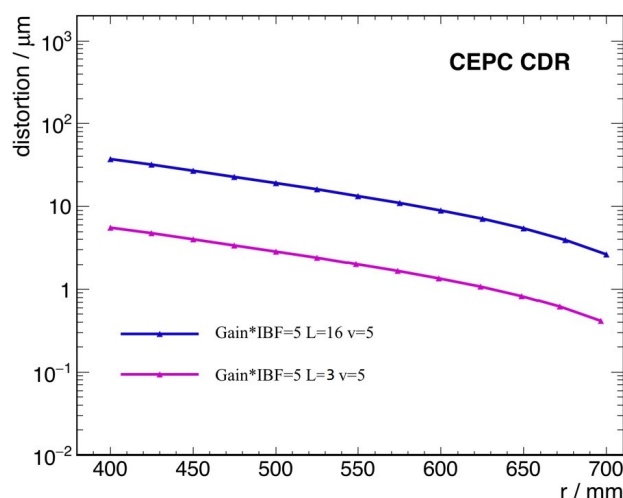

Figure 4.14: Distortion as a function of electron initial r position with different parameters.(Gain is the GEM-Micromegas, IBF is the ions back flow reducing rate,L is the key fact of the luminosity, and v is the drift velocity of the ions(m/s).)

Given the fact that the beam bunch is evenly distributed along the accelerator circumference, the voxel occupancy is extremely low ($1.4 \times 10^{-5}/1.4 \times 10^{-7}$ for the innermost layer and $3.4 \times 10^{-6}/3.4 \times 10^{-8}$ for average) and poses no pressure for the TPC usage. The distortion on TPC hit positions induced by the ion charges is estimated with dedicated program and calculation. At instant luminosity of 1×10^{36} and an ion backflow control of percent level, the distortion can be as significant as 10 mm at the innermost TPC layer at the CEPC conceptual detector geometry, which is two orders of magnitude larger than the intrinsic TPC spatial resolution.

A few approaches are proposed to reduce the effects caused by distortion:

1. Ion backflow control technology; the ion backflow should be controlled to per mille level, in other words, only 1 – 10 backflow ions are allowed for each primary ionization.
2. Dedicated distortion correction algorithm, for the innermost layers, which should result in a mitigation of the hit position distortion by one order of magnitude.
3. Adequate track finding algorithm that could link the TPC track fragments to vertex tracks at high efficiency and purity.

1 Taking all of these approaches account, the distortion can be mitigated by approxi-
 2 mately the safe factors of magnitude. To conclude, the pad occupancy and distortion
 3 stress no pressure to CEPC and if the above items can be achieved.

4 Distortion of Ions backflow in drift length

5 Early TPCs were equipped with multi-wire proportional chambers (MWPCs) as gas am-
 6 plification devices. The IBF ratio in a standard MWPC is 30 – 40%, so a gating grid
 7 is essential to prevent ions from reaching the drift volume. In the presence of a trigger,
 8 the gating grid switches to the open state to allow ionization electrons to travel into the
 9 gas amplification region. After a maximum drift time of about 100 μs the gating grid
 10 is closed to prevent positive ions from drifting back into the drift volume. Since it must
 11 remain closed until the ions have been collected on the grid wires, the ionization electrons
 12 are also blocked during this time and the dead time consequently increases.

13 Triggered operation of a gating grid will, therefore, lead to loss of data. Thus, the TPC
 14 at the proposed circular collider will have to be operated continuously, and the backflow
 15 of ions must be minimized without the use of a gating grid.

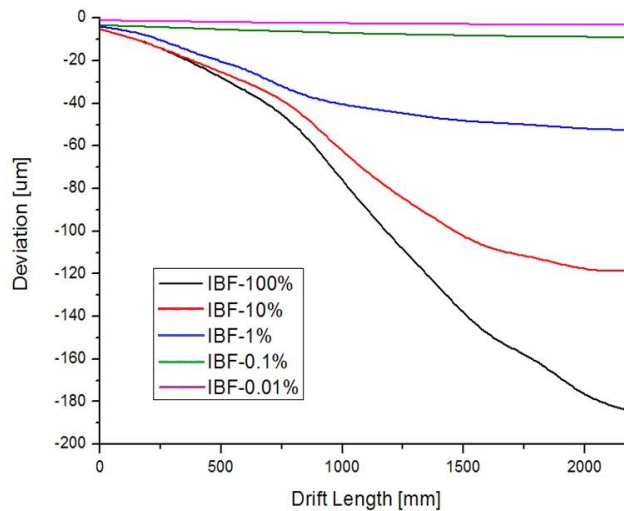

Figure 4.15: Evaluation of track distortions due to space charge effects of positive ions. IBF is the ions back flow reducing rate of the number of the ions back in the drift chamber divided the number of the ions from avalanche.

16 The ions generated from the ionisation in the drift volume or from the avalanche mul-
 17 tiplication and have found their way into the drift region will not only introduce field
 18 distortion, but also reduce the TPC counting rate capability. This effect is called ion back-
 19 flow, and should be fully suppressed in the TPC drift volume. With an averaged 300 eV
 20 required by per ion-electron ionisation and 2 keV energy loss per milli-meter, there will
 21 be roughly many primary electrons generated by a track with a typical length of 1.8 m.
 22 With the electron drift velocity of 5 cm/ μs , it takes $\sim 40 \mu\text{s}$ for all the electrons to drift
 23 2 m to reach the end-plate. With the expected bunch spacing of 0.68 μs at the CEPC,
 24 there will be about 60 events overlapping in the TPC volume. Therefore there will be
 25 $240\text{k} \times 60 / 2 = 7.2 \text{ M}$ electrons continuously drifting toward the end-plate. On the other
 26 hand, ions drift much slower than electrons, with a velocity of only 5 m/s in an electric
 27 field of 500 V/cm. This leads to ions from 600,000 events overlapping in the TPC volume.
 28 All of the ions should be reduce continuously.

4.2.1.4 Feasibility study of TPC detector module and future work

Hybrid structure TPC detector module

TPC readout with micro-pattern gaseous detectors (MPGDs), especially Gas Electron Multipliers (GEM) and micro-mesh gaseous structures (Micromegas), is very attractive, because the IBF of those detectors is intrinsically low, usually around a few percents. GEM detectors have been extensively proved in the last decade to be the prime candidate, as they offer excellent results for spatial resolution and low IBF. Numerous GEM foils can be cascaded, allowing multilayer GEM detectors to be operated at an overall gas gain above 10^4 in the presence of highly ionized particles. Micromegas is another kind of MPGD that is likely to be used as endcap detectors for the TPC readout. It is a parallel plate device, composed of a very thin metallic micromesh which separates the detector region into a drift and amplification volumes. The IBF of this detector is equal to the inverse of the field ratio between the amplification and the drift electric fields. Low IBF, therefore, favors high gain. However, the high gain will make it particularly vulnerable to sparking. The idea of combining GEM with Micromegas was first proposed with the goal of reducing the spark rate of Micromegas detectors. Pre-amplification using GEMs also extends the maximum achievable gain, so there have also been studies on gaseous photomultipliers with this hybrid configuration.

The TPC detector at the proposed circular collider will have to be operated continuously and the IBF of ions must be minimized without the open/close time of a gating device technology. The gain of the selection detector module can be achieved up to about 5000 without any obvious discharge behaviour. The currents on the anode and drift cathode were measured precisely with an electrometer. The experimental results showed that IBF can be reduced to $\sim 0.1\%$ at the gain of about 5000.

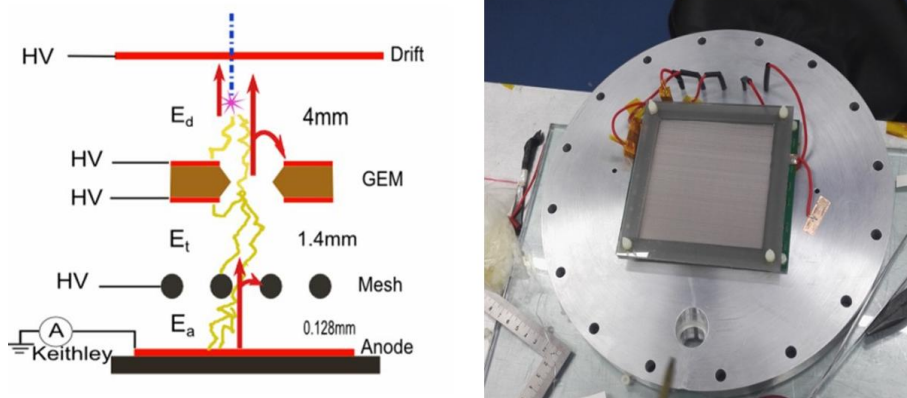

Figure 4.16: Schematic diagram of the detector module using GEM+Micromegas detector with 100mm^2 active area. (Left: the diagram of the hybrid structure detector concept for CEPC, Right: the photo of the detector prototype designed basing this concept)

To accomplish the physics purposes of the future circular collider, a TPC with superior performance is required. MPGDs with outstanding single-point accuracy and excellent multi-track resolution are needed. We have proposed and investigated the performance of a novel configuration detector module: a combination of GEM and a Micromegas. The detector will be called GEM-MM for short throughout this paper. This study aims to suppress IBF continually by eliminating the gating grid. The design concept and some preliminary results of the detector module are described as following.

^{55}Fe X-ray source with a characteristic energy of 5.9 keV was used in the test. In the argon-based working gas mixture, a typically pulse height spectrum for a GEM or Micromegas detector contains one major peak corresponding to the 5.9 keV X-rays and an escape peak at lower pulse heights corresponds to the ionization energy of an electron from the argon K-shell.

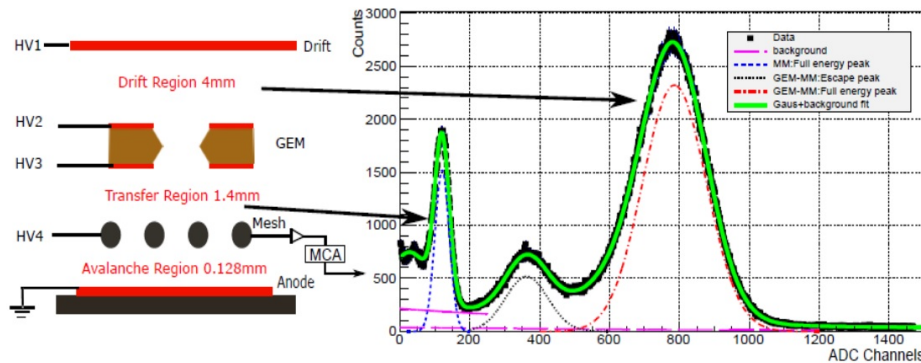

Figure 4.17: Energy spectrum of the hybrid structure TPC detector module with ^{55}Fe radioactive source. (The green curve is the whole energy spectrum from the hybrid detector, the last two peaks amplified by GEM and Micromegas, the first two peaks amplified by Micromegas only.)

In the GEM-MM detector, the situation is different. There are two amplification stages inside this detector. The primary ionization created by photon absorption can be in the drift region or in the transfer region (Figure 4.17). Photoelectrons starting from the drift region get amplified by both the GEM detector and the Micromegas detector before they are collected on the anode. If the photons are absorbed in the transfer region, the primary electrons will be amplified only once (by Micromegas).

Figure 4.17 depicts a typical ^{55}Fe pulse height spectrum obtained by the GEM-MM detector. Four peaks are seen in the pulse height spectrum. From left, the first peak and the second peak are the escape peak and the full energy peak of the stand alone Micromegas. The last two peaks are created by photons with their energy deposited in the drift region. These primary electrons show combination amplification. The principle of the GEM-MM detector is fully verified.

Another issue should be considered that is the space charge effect to reduce the IBF value. To quantify the effect of IBF in terms of resulting space-charge distortions one can study the gas-dependent parameters as a function of the space-charge density. We make the experiment to confirm the IBF value according to the different X-ray's voltage and current.

Our IBF results just obtained in the green rectangle area, there is no any obvious discharge or spark, and there is no high electrons to led the high space charge to reduce the value of IBF.

A new concept in IBF reduction uses a hybrid structure with one GEM foil above a MicroMegas detector. A prototype has been built, and tests have been carried out in Ar/CO_2 (90/10) gas mixture with a ^{55}Fe X-ray source. The pre-amplification effect of GEM foil has been demonstrated in the energy spectrum measurement. With the novel hybrid structure, the effective gain of the GEM can be measured even when it is relatively low. The energy resolution of this hybrid structure gaseous detector is measured to be

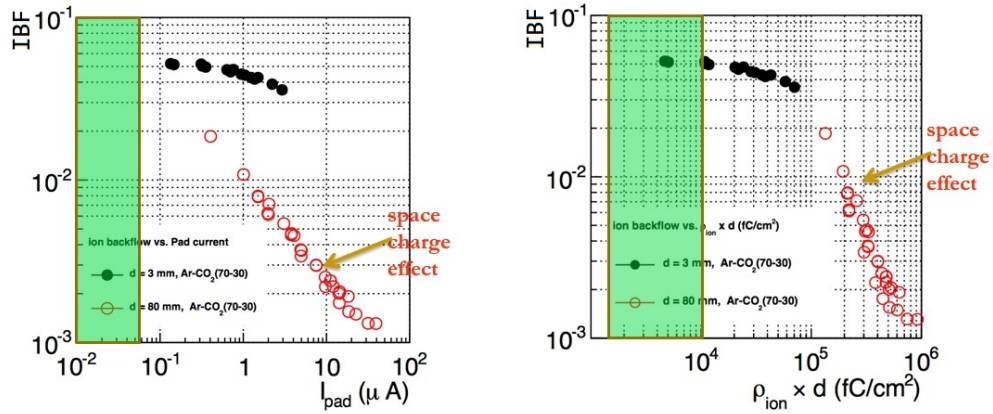

Figure 4.18: Comparison of the IBF with the different X-ray's voltage and current. (The test results of the detector prototype appear in the green area and there is no the space charge effect, it means that the IBF rate is the IBF controlling intrinsic possibility.)

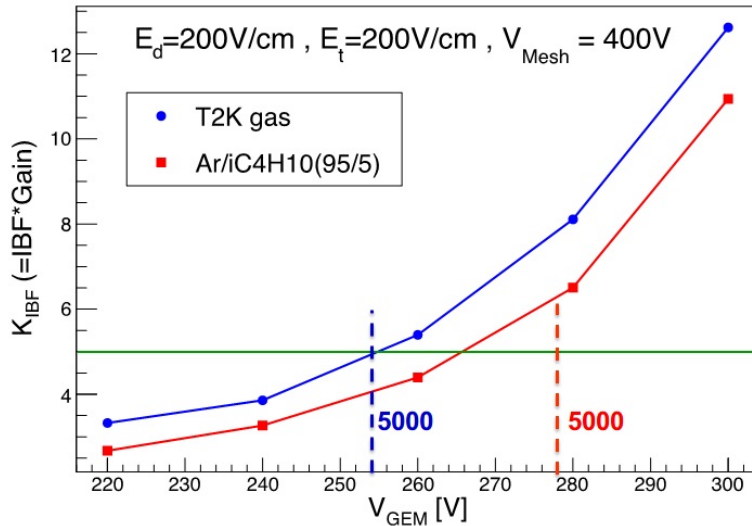

Figure 4.19: IBF Result of TPC detector module operating in the different mixture gases. (5000 is the detector prototype's gain at the different operating voltage, the results show that the $Gain \times IBF$ could reach to 5 in the T2K gas, and the $Gain \times IBF$ could reach to 7 in the Ar/iC_4H_{10} gas. The T2K mixture gas will be acted as the baseline gas for the hybrid detector.)

1 27%(FWHM). The gain properties of this device were measured. A gain up to about 5000
 2 can be achieved without any apparent discharge behavior. The currents on the anode and
 3 drift cathode were measured precisely with an electrometer. Out experimental measure-
 4 ments show that IBF can be reduced down to 0.19% at a gain of about 5000.

5 In 2018, the parameters of the electric field of drift, transfer, GEM detector and Mi-
 6 cromegas detector have been optimized testing. The key factor of the gas gain times IBF
 7 obtained at the mixtures gases of T2K and Ar/iC_4H_{10} separately. The new results has
 8 been shown in the Figure4.19.

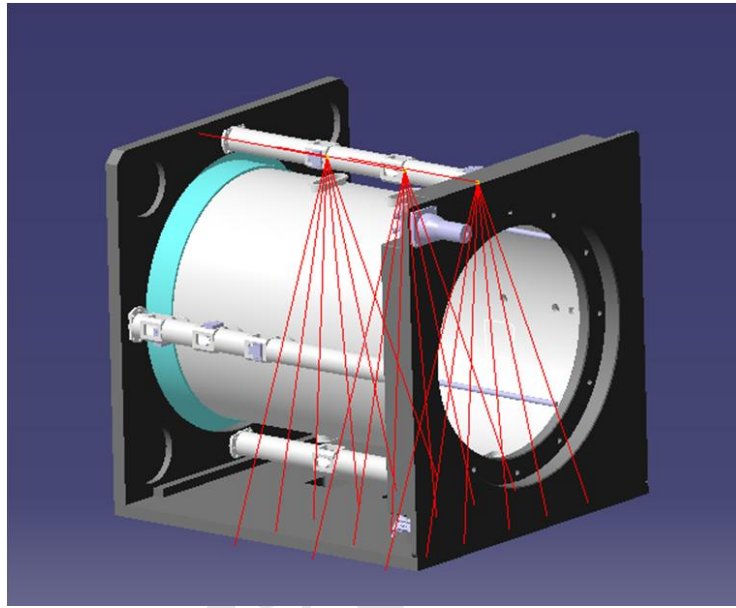

Figure 4.20: Schematic diagram of the detector module with the 266nm laser system. (The red lines are the split laser beam injection the drift chamber and every laser beam's position stability could be kept in $20\mu m$)

9 Laser calibration and alignment system

10 Alaser calibratio system with narrow laser beams inside the drift volume to simulate
 11 ionizing tracks at predefined locations will be used for calibration and distortion mea-
 12 surements. The goal is to obtain a uniformity of the TPC drift field within a reasonable
 13 relative error corresponding to a spacial resolution of $\sigma_{r\phi} = 100\mu m$. The system can
 14 be used for tests and calibration either outside or during normal data taking with the aim
 15 of understanding the chamber performance. Of particular interest is the testing of elec-
 16 tronics, alignment of the read-out chambers, and measurements of variations of the drift
 17 velocity due to mechanical imperfections and non-uniformities in the gas, temperature
 18 and the electric and magnetic fields.

19 The laser system would be used for calibration and distortion measurement in the pro-
 20 totype with one module as a readout or large, A Nd:YAG laser with a wavelength of
 21 266nm shall be used to study the track distortions. An additional UV-lamp could gener-
 22 ate additional ions. The complete optical path and the laser power will be split into
 23 6 – 7 laser tracks. The laser map coupling into the chamber and the planned laser tracks
 24 could be designed. The UV laser beam for calibration and alignment purposes to monitor
 25 the drift velocity, operation gas, gain uniformity and electric field. Nd:YAG laser device

- 1 with 266nm wavelength could make the ionization in the gas volume along the laser path
 2 occurs via two-photon absorption by organic impurities. The laser power should reach
 3 $\sim 10\mu J/mm^2$ to equal 10MIP.

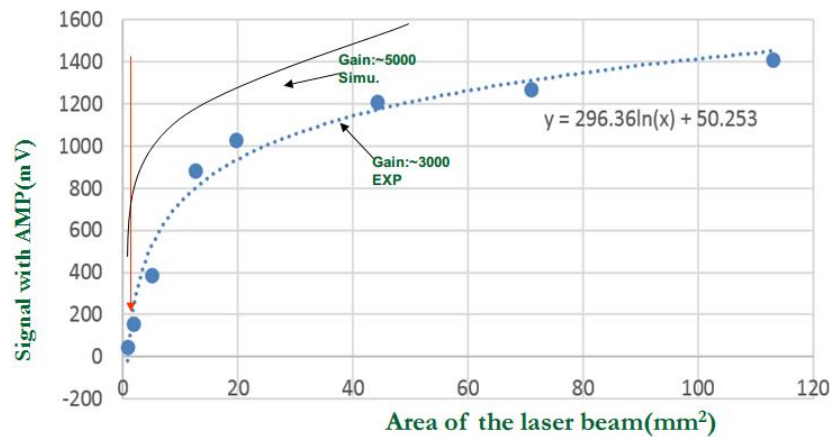
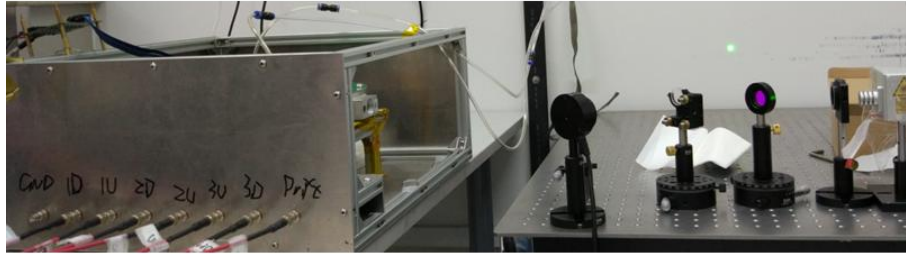

Figure 4.21: Signal with the different size of laser beam.(The beam size is the diameter of the laser beam, the test has been done at the gain of 3000 to keep the detector safe. The final results will be dedicated that the output signal is 300mV-500mV at the gain of 5000 when the diameter of the laser beam was set 0.8mm)

- 4 ▪ Photoelectric laser source with UV light source: Enlightens the cathode with UVs
 5 could produce photoelectrons to study and monitor distortions, the cathode with UVs
 6 to produce photoelectrons to study and monitor distortions, Deuterium lamp with
 7 160nm – 400nm of the wavelength as UV light source and smooth Aluminum film as
 8 a cathode. To mimic the bunch structure and the ions distortion with UV light lamp by
 9 the specific time structure shine controller, UV could create more than about 10000
 10 *electrons/s.mm²*.
- 11 ▪ Calibration laser beam size: The shine and entrance window could use the fused silica
 12 as of 99% *trans.*@266nm. Provides a UV laser beam for calibration and alignment
 13 purposes to monitor the drift velocity, operation gas, gain uniformity and electric
 14 field. The ionization in the gas volume along the laser path occurs via two-photon
 15 absorption by organic impurities. The study has been done using Nd:YAG laser device
 16 has the 266nm of wavelength(4.68eV). The optimization laser beam area of the laser
 17 device will be the range from 0.8mm² to 1.0mm² in the figure4.21.

18 To solve the critical technology problems in CEPC, the hybrid structure MPGD de-
 19 tector module has been developed, and some preliminary results have been obtained and
 20 analyzed, the further study will be done from this combination detector module. Another

1 small TPC prototype with 266nm laser calibration system and UV photoelectric func-
 2 tion has been designed and would be assembled, and the calibration experiment would be
 3 further studied for CEPC.

4 4.2.1.5 Conclusion

5 The TPC designed following the CEPC CDR concept provides an excellent starting point
 6 for the CEPC TPC R&D, but numerous modifications are foreseen due to the different
 7 performance requirements and experimental conditions. Several critical R&D issues have
 8 been identified in pre-studies. Possible solutions to those issues have been suggested and
 9 will have to be verified with a prototype TPC in future.

10 Aiming for the CDR and next steps of the CEPC project, two-phase funding scheme
 11 is proposed by the funding agency, the Ministry of Science and Technology (MOST) of
 12 China. To launch the project, the MOST funded the CEPC accelerator and detector R&D
 13 project for phase-I period of 2016 – 2021. Among sub-detectors, the feasibility study
 14 of the TPC tracker detector was initiated for the purpose to identify feasible technology
 15 options and to gain expertise to build the detector units which meet the basic requirements
 16 of the CEPC detector design.

17 4.2.2 Silicon tracker

18 The silicon tracker and the TPC (Time Projection Chamber, see Section 4.2.1) together
 19 with the vertex detector form the complete baseline tracking system of CEPC. With suffi-
 20 ciently low material budget to minimize the multi-scattering effect, the silicon tracker pro-
 21 vides additional high-precision hit points along trajectories of charged particles, improv-
 22 ing tracking efficiency and precision significantly. In addition to complementary tracking,
 23 it also provides the following functionalities:

- 24 ▪ monitoring possible field distortion in the TPC,
- 25 ▪ contributing detector alignment,
- 26 ▪ separating events between bunch crossings with relative time-stamping,
- 27 ▪ potentially dE/dx measurement.

28 The CEPC physics requirements put a required performance on the central tracker as

$$\sigma_{1/p_T} = a \oplus \frac{b}{p \sin^{3/2} \theta} \quad [\text{GeV}^{-1}] \quad (4.2)$$

29 with p and p_T in GeV and θ the polar angle with

$$a \sim 2 \times 10^{-5} \text{ GeV}^{-1} \quad \text{and} \quad b \sim 1 \times 10^{-3}. \quad (4.3)$$

30 At low momenta, less than 50 GeV for perpendicular tracks, the resolution is dominated
 31 by the multiple scattering effect, and at high momenta, the resolution is dominated by the
 32 single-point resolution. Hence, stringent constraint has to be put on material budget.

33 4.2.2.1 Baseline design

34 The silicon tracker consists of four components: the Silicon Inner Tracker (SIT), the
 35 Silicon External Tracker (SET), the End-cap Tracking Detector (ETD) and the Forward

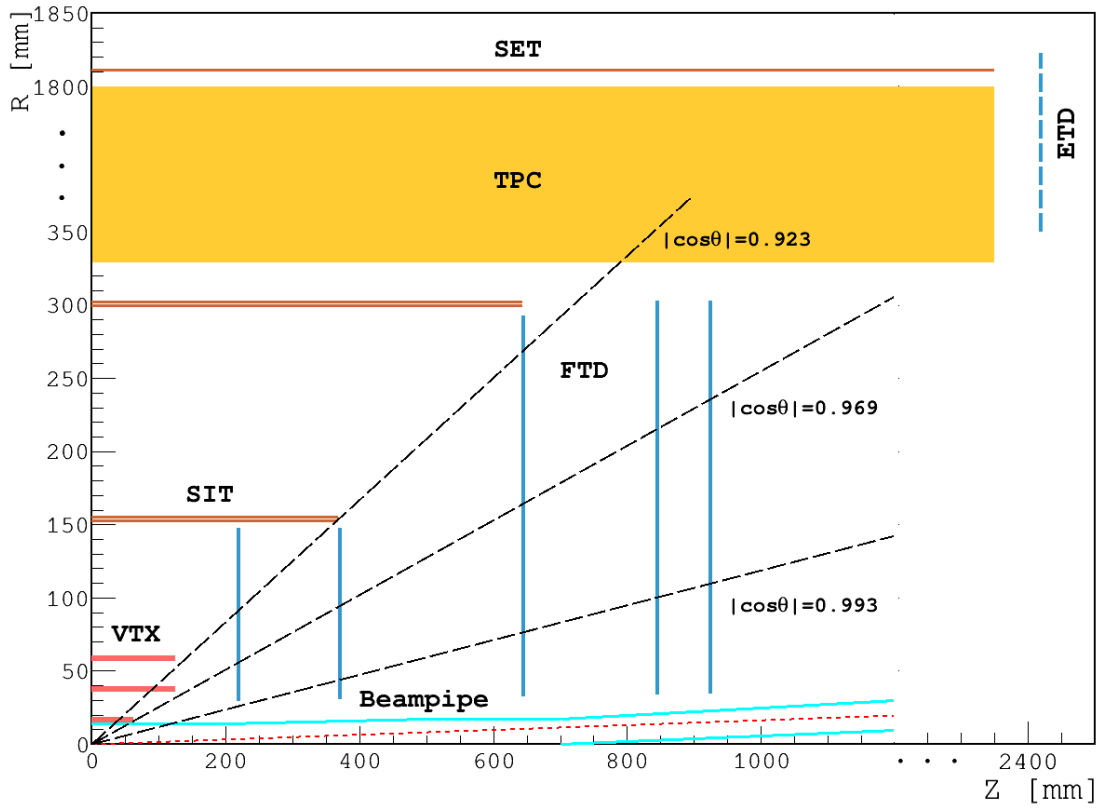

Figure 4.22: Preliminary layout of the CEPC silicon tracker. The red lines indicate positions of the vertex detector layers, orange lines for the SIT and SET components of the silicon tracker, the grey-blue lines for the FTD and ETD components of the silicon tracker, and the cyan lines for the beampipe. The ETD line is a dashed line because it is not in the present full simulation.

Table 4.5: Main parameters of the CEPC silicon tracker.

Detector		Radius R [mm]	z [mm]	Material budget [X_0]
SIT	Layer 1:	153	371.3	0.65%
	Layer 2:	300	664.9	0.65%
SET	Layer 3:	1811	2350	0.65%
FTD	Disk 1:	$R_{in} = 39$ $R_{out} = 151.9$	220	0.50%
	Disk 2:	$R_{in} = 49.6$ $R_{out} = 151.9$	371.3	0.50%
	Disk 3:	$R_{in} = 70.1$ $R_{out} = 298.9$	644.9	0.65%
	Disk 4:	$R_{in} = 79.3$ $R_{out} = 309$	846	0.65%
	Disk 5:	$R_{in} = 92.7$ $R_{out} = 309$	1057.5	0.65%
ETD	Disk:	$R_{in} = 419.3$ $R_{out} = 1822.7$	2420	0.65%

Tracking Detector (FTD). The overall layout is shown in Figure 4.22, and the main parameters are summarized in Table 4.5.

The barrel components SIT and SET provide precise hit points before and after the TPC, improving the overall tracking performance in the central region. The SIT helps the link between the vertex detector and the TPC, enhancing the reconstruction efficiency, particularly for low-momentum charged particles. The SET sits between the TPC and the calorimeter and helps in extrapolating from the TPC to the calorimeter. In addition, the good timing resolution of silicon sensors provides time-stamping for bunch separation.

The ETD is positioned in the gap between the endplate of the TPC and the end-cap calorimeter. It helps to reconstruct charged particles with a reduced path in the TPC. The SIT, SET and ETD covers the central tracking region. They form the complete silicon envelope and help in calibrating the tracking system. The ETD has not been included in the current version of full simulation.

The FTD is installed between the beam pipe and the inner cage of the TPC, covering the very forward region. It consists of five silicon disks on each side. The FTD is essential for precise and efficient tracking down to very small (or large) polar angles, where a number of challenges exist: the magnetic field approaching zero along the beam pipe, significantly larger occupancies due to forward going jets and high backgrounds from the interaction region. To achieve the best tracking performance, the FTD needs precise space points, a large lever arm, but low material budget.

4.2.2.2 Sensor technologies

The basic sensor technology is silicon microstrips for all tracker components except the two innermost FTD disks where silicon pixels are foreseen. Requirements of the single point resolution vary with positions of tracker components, but a general condition of $\sigma_{SP} < 7 \mu\text{m}$ is required for high precision tracking. The microstrip sensors have proven to be capable of the resolution, taking into account material budget and power consumption. The baseline features of microstrip sensors will be a large detection area of $10 \times 10 \text{ cm}^2$, a fine pitch of $50 \mu\text{m}$ and the thickness $< 200 \mu\text{m}$ to minimize the multi-scattering effect.

An alternative that is being investigated is a fully pixelated silicon tracker. Although the choice of pixel technologies is open, the CMOS pixel sensors (CPS) have gained particular interest because of two main performance advantages compared to the microstrip sensors:

- Granularity. The CPS provides better single-point spatial resolution and significantly reduces the ambiguity caused by multiple hits in a single strip.
- Material budget. The CPS can be thinned to less than $50 \mu\text{m}$, whereas the strip sensor is usually a few hundred microns.

In addition, production cost could be significantly reduced for fabricating large area sensors because CPS is based on standard CMOS procedure in industry. And it's possible to embed circuits in the pixel to simplify the tracker readout circuitry. Initial R&D on large area CPS has been carried out.

The pixelated silicon tracker alternative is used to set data acquisition requirements because it is more demanding. Table 4.6 estimates the pixel occupancy of SIT-L1 and FTD-D1 based on a few assumptions.

1. The pixel dimension is assumed to be $50 \mu\text{m} \times 350 \mu\text{m}$, with which at least in one dimension spatial resolution can reach $7 \mu\text{m}$ by implementing in-pixel ADC with multiple bits.

- 1 2. The track multiplicities in different operation modes are inferred from hit densities in
- 2 Table 9.4.
- 3 3. Readout time of pixel sensors is set as $10\ \mu\text{s}$, the same as that of VTX.
- 4 4. Cluster size is set as 9 hits per track.

Table 4.6: Pixel occupancy of SIT-L1 and FTD-D1. See context for explanations.

operation mode	H (240)	W (160)	Z (91)
track multiplicity (BX^{-1})	310	300	32
bunching spacing (ns)	680	210	25
SIT-L1 occupancy (%)	0.19	0.58	0.52
FTD-D1 occupancy (%)	0.17	0.54	0.48

5 4.2.2.3 Front-End electronics

6 The Front-End (FE) electronics will depend on the choice of sensor, namely microstrips
7 or pixels.

8 For the microstrips, custom designed ASICs with deep sub-micron CMOS technol-
9 ogy will be used. The chips will provide functions of the analogue to digital conversion
10 (ADC), zero suppression, sparcification and possibly time stamping, together with nec-
11 essary control circuitry. The high degree digitization is for relaxing the data processing
12 pressure on downstream electronics.

13 As for the pixels, all FE functions can be realized in a pixel chip, even with some func-
14 tions, e.g., ADC on pixels themselves. Particular concerns are readout time and electronic
15 channels.

16 Commonly, the FE chip will be developed in mind with low noise, low power consump-
17 tion and high radiation tolerance. New developments, such as in the SiLC collaboration
18 and the LHC experiment upgrades, will be good references.

19 4.2.2.4 Powering and cooling

20 Powering and cooling are a challenge for the CEPC silicon tracker. It is important to in-
21 vestigate the novel powering scheme based on DC-DC converters, which has been already
22 actively pursued by the ATLAS and CMS experiments for silicon detector upgrades [31–
23 33]. It allows significant reduction in material budget for the low-voltage power cables
24 and gives less power dissipation in the delivery system. Cooling is another critical issue.
25 Although cooling based on forced cooled gas flow might be still feasible to efficiently con-
26 duct away the heat generated by the sensors, ASICs and other electronics, it is important
27 to look into other cooling techniques, such as silicon micro-channel cooling [34], which
28 are being investigated by several other experiments. The technique chosen will have to
29 provide sufficient cooling without compromising the detector performance.

30 4.2.2.5 Mechanics and integration

31 There will always be additional challenging aspects of the mechanical design for a large
32 area silicon tracker. A lightweight but stiff support structure can be built based on Car-
33 bon fibre Reinforced Plastic material [35]. The support structure, cable routing and elec-
34 tronics common to other sub-detectors need to be carefully designed to minimize the

1 overall quantity of material and make easy construction and integration possible. Precise
 2 and quick system alignment might be achieved with dedicated laser monitoring systems,
 3 while the final alignment will be accomplished using tracks from well-understood physics
 4 events [36].

5 **4.2.2.6 Critical R&D**

6 Silicon technology for large-area tracking detectors will continue to evolve over the next
 7 few years [37]. There are ongoing R&D activities conducted by the ATLAS and CMS
 8 experiments to develop advanced silicon detectors for the High Luminosity LHC as well
 9 as several pioneering R&D projects by the SiLC (Silicon tracking for the Linear Collider)
 10 collaboration. Despite the rather different operation conditions and requirements, it is
 11 always important to exploit synergies with existing R&D from other experiments to share
 12 expertise. During the preliminary studies, several critical R&D items have been identified
 13 for the CEPC silicon tracker. All of them, as listed below, will be pursued in the R&D
 14 phase of the CEPC project and made available for engineering construction.

- 15 ▪ Alternative pixelated strip sensors with CMOS technologies;
- 16 ▪ p^+ -on-n silicon microstrip sensors with slim-edge structure;
- 17 ▪ Front-end electronics with low power consumption and low noise, fabricated with
 18 CMOS technologies of small feature size;
- 19 ▪ Efficient powering with low material budget and CO_2 cooling techniques;
- 20 ▪ Lightweight but robust support structure and related mechanics;
- 21 ▪ Detector layout optimization, in particular in the forward region.

22 It will be vital to develop necessary instrumentation for the module assembly and to
 23 verify the detector module performance with beam tests. Prototypes of support structures,
 24 including cooling solutions, shall be also built for mechanical and thermal tests.

25 **4.2.3 TPC and Silicon tracker performance**

26 The performance study described in the section is based on the vertex detector and the
 27 silicon tracker.

28 While the tracking performance in the central region has been extensively studied, the
 29 performance in the forward region, which has been designed to cope with the rather short
 30 L^* , requires additional careful evaluation. Figure 4.23 shows the estimated transverse
 31 momentum resolution for single muon tracks for two polar angles $\theta = 20^\circ$ and 85° , and
 32 the analytical results from Equation (4.2) and Equation (4.3). Due the reduced lever arm
 33 of the tracks and fewer FTD disks in the forward region ($\theta = 20^\circ$), the resolution is worse.

34 **4.3 Full-silicon tracker detector**

35 A full-silicon tracker is also an option for the CEPC Main Tracker. It offers a well known
 36 technology that provides excellent space point resolution and granularity to cope with
 37 track separation in dense jets and hits from the high luminosity beam related background.

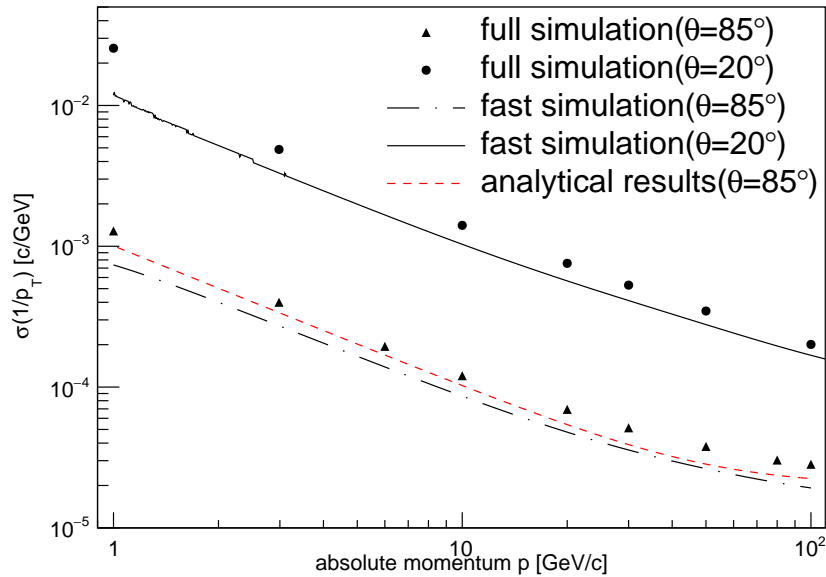

Figure 4.23: Transverse momentum resolution for single muon tracks as a function of the track momentum estimated for the CEPC baseline design with full simulation (dots) and fast simulation (black lines) compared to the analytical results obtained with Eqs. 4.2 and 4.3 (red line).

1 Potential drawbacks include the relatively high material density within the tracking sys-
 2 tem, fewer space points available for pattern recognition, and limited dE/dx measure-
 3 ments.

4 This Section will demonstrate that the full-silicon tracking concept is a viable option
 5 for CEPC. The layout presented here is constrained to fit within the main tracker detector
 6 envelope in the CEPC baseline layout of TPC and silicon tracker in the previous section.
 7 Thus, they share the same vertex tracker as well as the same calorimeter. While the bound-
 8 ary conditions are held fixed in this study, we have optimized the layout with the number
 9 of silicon layers, single vs double sided, and support material. Relaxing these constraints
 10 are expected to yield further optimization. The parameters used in this simplified simula-
 11 tion study are summarized in the following:

- 12 ▪ the solenoid B field is set to 3 Tesla,
- 13 ▪ the tracking envelope consists of a cylinder with a radius of 1.83 m and a length of
 14 4.6 m,
- 15 ▪ the tracker covers down to 7.25 degree from the beam pipe,
- 16 ▪ the Be beam pipe has a radius of 1.45 cm and 14 cm long.

17 4.3.1 Full silicon tracker layout

18 Two layouts have been investigated in this study.

19 The first, referred to as FST, has six double-strip layers in the barrel region and five
 20 double-strip layers in the endcap region. The barrel strips are labeled SOT and the endcap
 21 strips are labeled EOT. Together with the six vertex tracker pixel hits, this layout provides
 22 12 precisely measured points for all tracks in the central region, and at least 7 points down

to a polar angle of about 7.25 degree, as shown in Figure 4.25. The six vertex tracker pixel hits and the forward disks of FST are capable of excellent track finding on their own. The outer FST strip layers provide additional track-finding constraints at large radii where the hit density is low while improving the momentum measurement over a large layer arm with excellent hit resolution in the transverse plane.

The second alternative, referred to as FST2, provides information on the effect of having fewer hits. This layout has five single-sided strip layers in the barrel and four double-sided strip layers in the endcap as shown in Figure 4.24. The number of expected hits on the track from FST2 is also shown in Figure 4.25. Combined with the vertex tracker pixel hits, FST2 provides ten space points in the barrel region.

Tables 4.7 and 4.8 summarize the geometry parameters of the layer and disk configurations that were investigated for both FST and FST2. The total radiation length for all-silicon tracking systems, including dead material such as readout, cables and supports, is about 5-7% for FST and 7-10% for FST2, respectively.

VXD	FST			FST2		
	R (m)	$\pm z$ (m)		R (m)	$\pm z$ (m)	
Layer 1	0.016	0.078		0.016	0.173	
Layer 2	0.025	0.125		0.030	0.173	
Layer 3	0.037	0.150		0.054	0.173	
Layer 4	0.038	0.150		0.077	0.173	
Layer 5	0.058	0.175		0.100	0.173	
Layer 6	0.059	0.175				
EIT	R_{in} (m)	R_{out} (m)	$\pm z$ (m)	R_{in} (m)	R_{out} (m)	$\pm z$ (m)
Disk 1	0.030	0.151	0.221	0.015	0.074	0.104
Disk 2	0.051	0.151	0.368	0.016	0.074	0.130
Disk 3				0.018	0.074	0.171
Disk 4				0.021	0.074	0.247
Disk 5				0.028	0.163	0.290
Disk 6				0.076	0.163	0.745
Disk 7				0.118	0.163	1.145

Table 4.7: Geometry parameters for the pixel layers of the two full-silicon-tracker detectors (FST and FST2) discussed in the text. The vertex detector in the barrel region (VXD) has either 5 or 6 layers depending on the configuration. The Endcap Inner Tracker (EIT) is composed of two pixel disks in the FST case, and seven pixel disks in the FST2 case.

4.3.2 Expected Resolution

For each layout, we use the semi-analytical program IdRes, developed by the ATLAS experiment [38], to calculate the expected tracking resolution as function of track momentum for a given incident angle θ , in which the effects of multiple scattering due to the

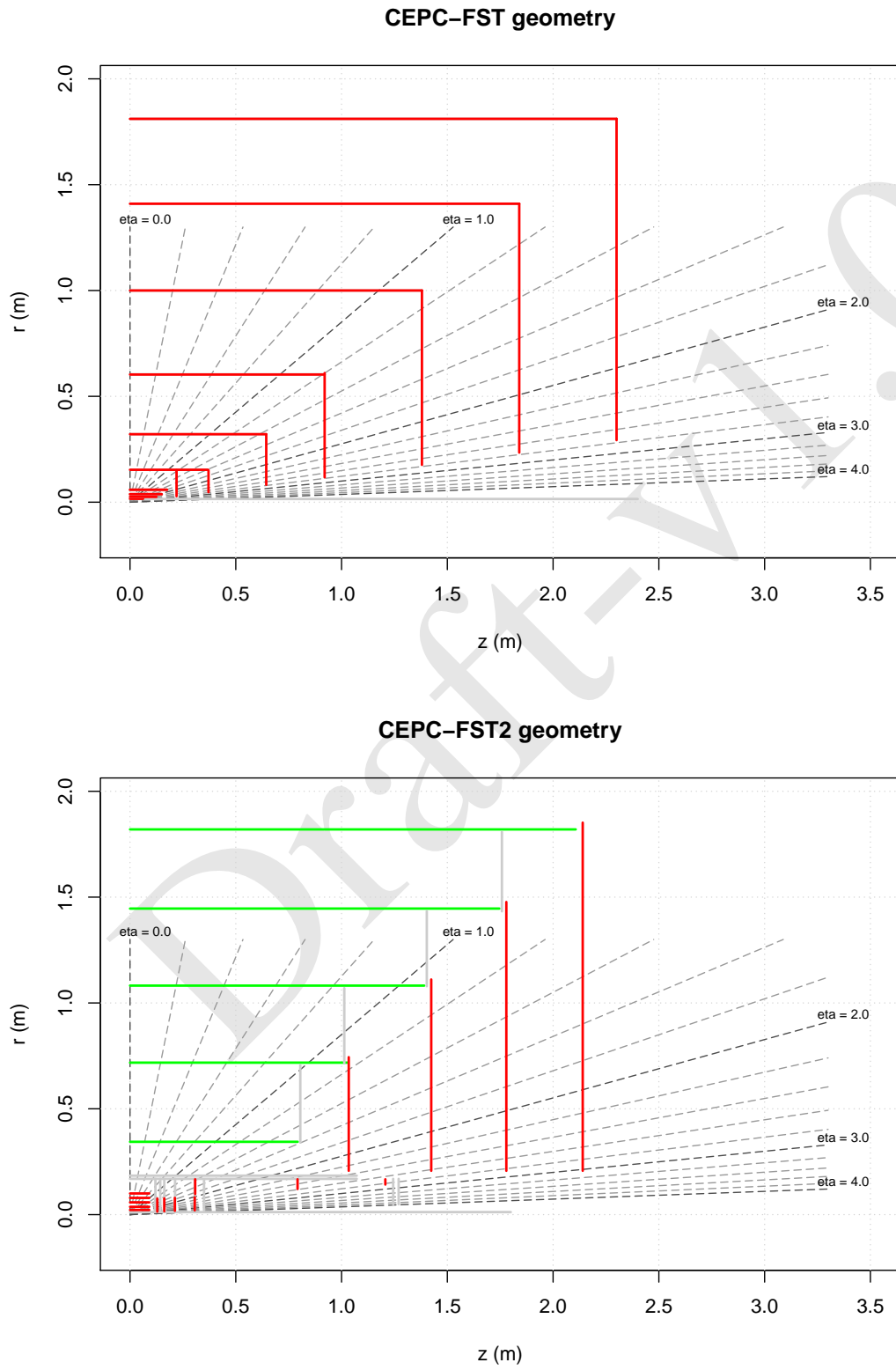

Figure 4.24: The R-Z view of the full silicon tracker proposed for FST (top) and FST2 (bottom).

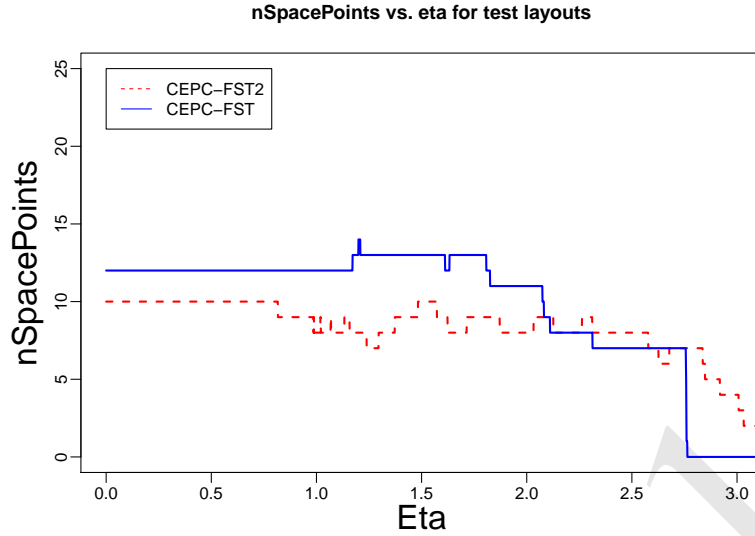

Figure 4.25: The number of expected hits are shown as function of track pseudo-rapidity.

1 material are taken into account. The results are cross checked using LDT program [39],
 2 which gives a consistent result. The coverage of the full-silicon tracking system is shown
 3 in Figure 4.25 as function of track pseudo-rapidity.

4 The expected transverse momentum (p_T) and impact parameters (d_0 , and z_0) resolutions
 5 are compared as function of track p_T for tracks with $\theta = 85$ and 20 degree, respectively,
 6 as shown in Figure 4.26. The z_0 resolution is better for FST than for FST2 due to extra
 7 stereo-strip layers while the p_T and d_0 resolutions in the barrel region are similar.

8 4.3.3 Detector simulation and reconstruction

9 In order to optimize the full silicon tracker detector for CEPC, we generate several bench-
 10 mark processes that include single muon events, $e^+e^- \rightarrow ZH \rightarrow \nu\nu\mu\mu$, and $e^+e^- \rightarrow$
 11 $ZH \rightarrow \nu\nu gg$ (two gluon jets). The events are then simulated and reconstructed using
 12 different detector geometries, which are then used for the tracking performance studies.

13 4.3.3.1 FST tracker

14 The performance of the FST tracker is studied using the same Mokka simulation tool
 15 used to study the CEPC baseline detector by substituting the FST tracker for the baseline
 16 tracker while keeping all other detector elements unchanged.

17 Edit strip detector details.

18 In order to improve the flexibility of design, a new package of SiTracker is implemented
 19 in Mokka which represents the silicon tracker by planar structure, which consists of a
 20 thin layer of silicon with $150 \mu m$ thickness and $50 \mu m$ pitch size. For VXD and SOT,
 21 they are composed by several layers, and each layer is composed by several ladders, and
 22 each ladder is divided to several sensors. The SOT layer consist of double silicon layers
 23 mounted back to back with a stereo-angle of 7 degree. The endcap tracker is composed
 24 by several pixel disks EIT and several double-side strip disks EOT that are composed
 25 by petals. The strip EOT disks have two sensitive silicon sub-layers on each side with

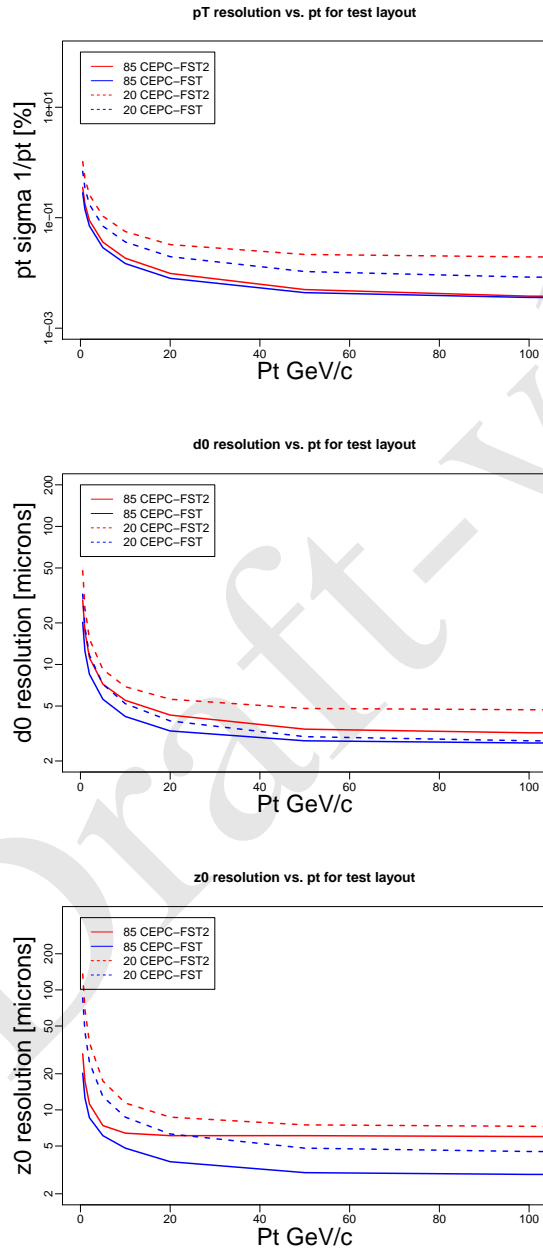

Figure 4.26: The expected p_T , d0, and z0 resolutions from the toy simulation (Idres) are compared as function of track p_T in GeV/c for tracks with $\theta = 85$ and 20 degree, respectively.

SOT	FST			FST2				
	R (m)	$\pm z$ (m)	Type	R (m)	$\pm z$ (m)	Type		
Layer 1	0.153	0.368	D	0.344	0.793	S		
Layer 2	0.321	0.644	D	0.718	1.029	S		
Layer 3	0.603	0.920	D	1.082	1.391	S		
Layer 4	1.000	1.380	D	1.446	1.746	S		
Layer 5	1.410	1.840	D	1.820	2.107	S		
Layer 6	1.811	2.300	D					
EOT	R_{in} (m)	R_{out} (m)	$\pm z$ (m)	Type	R_{in} (m)	R_{out} (m)	$\pm z$ (m)	Type
Disk 1	0.082	0.321	0.644	D	0.207	0.744	1.034	D
Disk 2	0.117	0.610	0.920	D	0.207	1.111	1.424	D
Disk 3	0.176	1.000	1.380	D	0.207	1.477	1.779	D
Disk 4	0.234	1.410	1.840	D	0.207	1.852	2.140	D
Disk 5	0.293	1.811	2.300	D				

Table 4.8: Geometry parameters for the strip layers of the two Full Silicon Tracker detectors (FST and FST2) discussed in the text, where D and S stand for double and single-sided strip layers. The Silicon Outer Tracker (SOT) has either 5 or 6 layers depending on the configuration. The Endcap Outer Tracker (EOT) is composed of either 4 or 5 disks, all double-sided.

a stereo-angle of 5 degree. The material budget of the whole tracker is about 5% in the barrel region and about 8% in the endcap region as shown in Figure 4.27, which also shows the contributions of each part of the tracker. In the endcap region, the zigzags are caused by the alternation and overlap of layers.

A conformal tracking algorithm developed for CLIC [40] has been adapted for use with the full silicon tracker here. Through the conformal transform $u = \frac{x}{x^2+y^2}$ and $v = \frac{y}{x^2+y^2}$, where x and y are the positions of the track hits in the detector space, the positions of the track hits in the conformal space lie at a straight line for the track in a magnetic field. Therefore, track finding becomes straight line searching in the pattern recognition. Currently, a cellular automaton is used as pattern recognition for the straight line searching.

4.3.3.2 FST2 tracker

In the case of FST2, events were simulated and reconstructed using software developed for the International Linear Collider (ILC) [41, 42]. The track reconstruction was performed with the LCSIM 4.0 package [40] using the “seed tracker” algorithm developed for the SiD detector simulation. Track candidates with at least six hits in the silicon pixel and microstrip layers were considered. Only tracks with a minimum transverse momentum (p_T) of 100 MeV were accepted. The track-fitting was performed with the following requirements; maximum distance of closest approach (DCA) is $|DCA| < 6$ mm, $|z_0| < 10$ mm, and fit $\chi^2 < 10$. The reconstruction includes particle-flow algorithms (PFA) which enable identification and reconstruction of individual particles. The PFA objects can be reconstructed using the software algorithms implemented in the PANDORA package [43, 44].

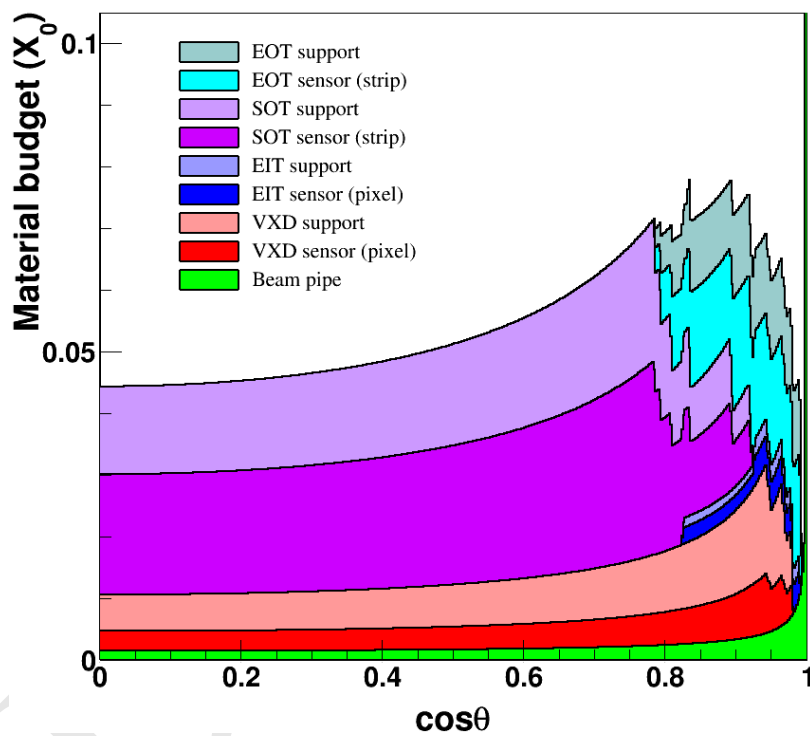

Figure 4.27: Material budget for the FST highlighting the contributions from the vertex detector (VXD) and strip detector (SOT) in the barrel region, and the pixel disks (EIT) and strip disks (EOT) in the endcap region. Comparing to the baseline detector, there are some differences on the thickness of the silicon layers and support materials considered.

4.3.4 Tracking performance

After the detector simulation and reconstruction, the tracking performances are measured in terms of efficiencies, fake rates, momentum resolution, and the impact parameter resolutions using single muons or $e^+e^- \rightarrow ZH$ events. The tracking efficiency is defined as a fraction of stable charged particles that can be matched to well reconstructed tracks. The stable particles are defined as those charged particles with $p_T > 1$ GeV/c in the detector fiducial region ($9 < \theta < 170$ degree), originated from the interaction point, and lived long enough to reach the calorimeter. A well reconstructed track is defined as sharing more than 50% of its assigned silicon hits originating from a single particle (truth hits). We define a truth hit fraction as ratio of truth hits over total assigned hits of the track using silicon hits only. A poorly reconstructed track is defined to have the truth hit fraction less than 50%. The fake rate is defined as the fraction of poorly reconstructed tracks out of total reconstructed tracks, but this requires a realistic detector simulation, which we are not there yet. Since the CEPC baseline and the CEPC-FST detectors are sharing the common software and design, we will focus on their tracking performance comparisons to demonstrate that the full-silicon tracking concept is a viable option for CEPC.

4.3.4.1 Single muon particle

Figure 4.28 shows the tracking efficiency for single muons in CEPC-FST as function of p_T . The tracking efficiency is close to 100% at high p_T and slightly lower at small p_T . The trend is the same for CEPC baseline (v_4), which indicate both trackers are capable of finding tracks efficiently in the detector fiducial region.

Since the track resolution depends on the track angle θ , we divide the tracks in the barrel region with $40 < \theta < 140$ degree and in the endcap region with $7.25 < \theta < 40$ degree or $140 < \theta < 172.75$ degree. Figure 4.29 shows the track resolutions of p_T , d_0 , and z_0 as function of track p_T in the barrel and endcap region. The resolutions seem comparable to each other, but they seem slightly better for the low momentum tracks in the CEPC v4 detector (TPC+Silicon) than CEPC-FST due to extra materia in the detector while they are compatible at the high p_T .

4.3.4.2 Di-muon mass resolution

Figure 4.30 shows the di-muon invariant mass distributions from $ZH \rightarrow \nu\nu\mu\mu$ decay between different detector configurations. The higgs mass used in the simulation is 125 GeV/c². The di-muon mass resolution from CEPC-FST has $\sigma = 0.21$ GeV/c² and seems 14% better than ones obtained from CEPC baseline detector.

4.3.4.3 Tracking inside the jets

In order to study the tracking performance inside the jets, we generated and simulated some Higgs decaying into two gluon jets (GG) in $zH \rightarrow \nu\nu GG$ events. Figure 4.31 shows the tracking efficiency inside the jets as function of track momentum. The efficiency of finding tracks inside the jets is very similar between the CEPC baseline and the CEPC-FST detectors, which is close to 97%.

4.3.5 Conclusion

We present a preliminary study of full silicon tracker option as an alternative design for CEPC tracker. Two approaches are considered for the design: the first is to keep the

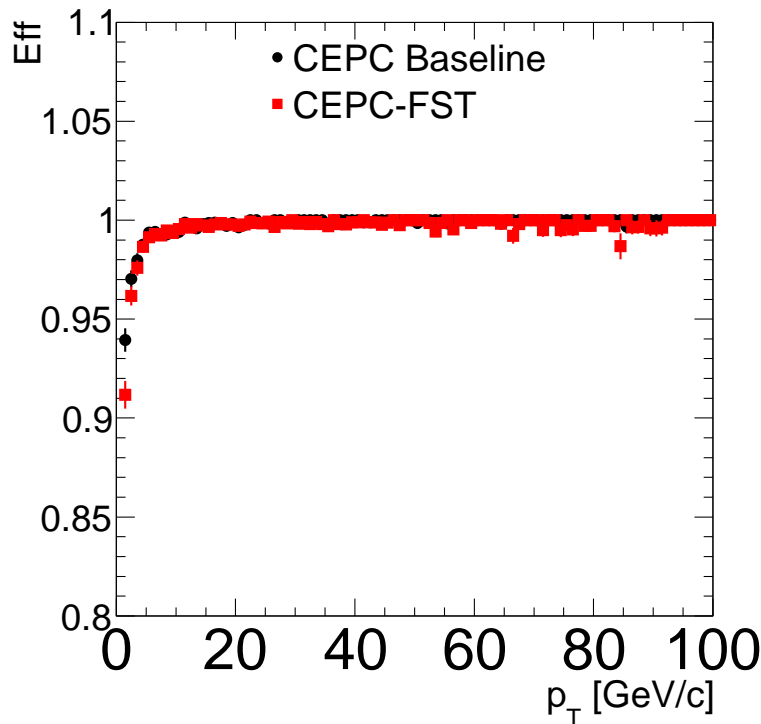

Figure 4.28: The tracking efficiencies are measured as function of p_T for single muons using CEPC baseline and CEPC-FST detectors.

1 silicon detectors (VXD, SIT, FTD) in the CEPC baseline detector and replacing TPC with
 2 additional silicon detectors, the second is to optimize the ILC-SID tracker to fulfil the
 3 CEPC tracking volume in order to achieve the excellent momentum resolution using 3
 4 Tesla B field. The new detector geometry has been implemented in the simulation and the
 5 track reconstruction has also been adopted for the full silicon tracker. The initial study of
 6 the tracking performance looks promising. There are still many improvements needed in
 7 the simulation and reconstruction in order to explore the full potential of the full-silicon
 8 tracker.

9 4.4 Drift chamber tracker detector

10 4.4.1 Introduction

11 The drift chamber (DCH) is another option for the CEPC Main Tracker. It is designed
 12 to provide good tracking, high precision momentum measurement and excellent particle
 13 identification by cluster counting.

14 The special feature of this drift chamber is its high transparency, in terms of radia-
 15 tion lengths, obtained thanks to the novel approach adopted for the wiring and assembly
 16 procedures. The design concept originated with the KLOE experiment[45], and more
 17 recently culminated in the realisation of the MEG2[46] drift chamber. As implemented
 18 here for the CEPC main tracker, the total amount of material in radial direction, towards
 19 the barrel calorimeter, is of the order of 1.6% X_0 , whereas, in the forward and backward

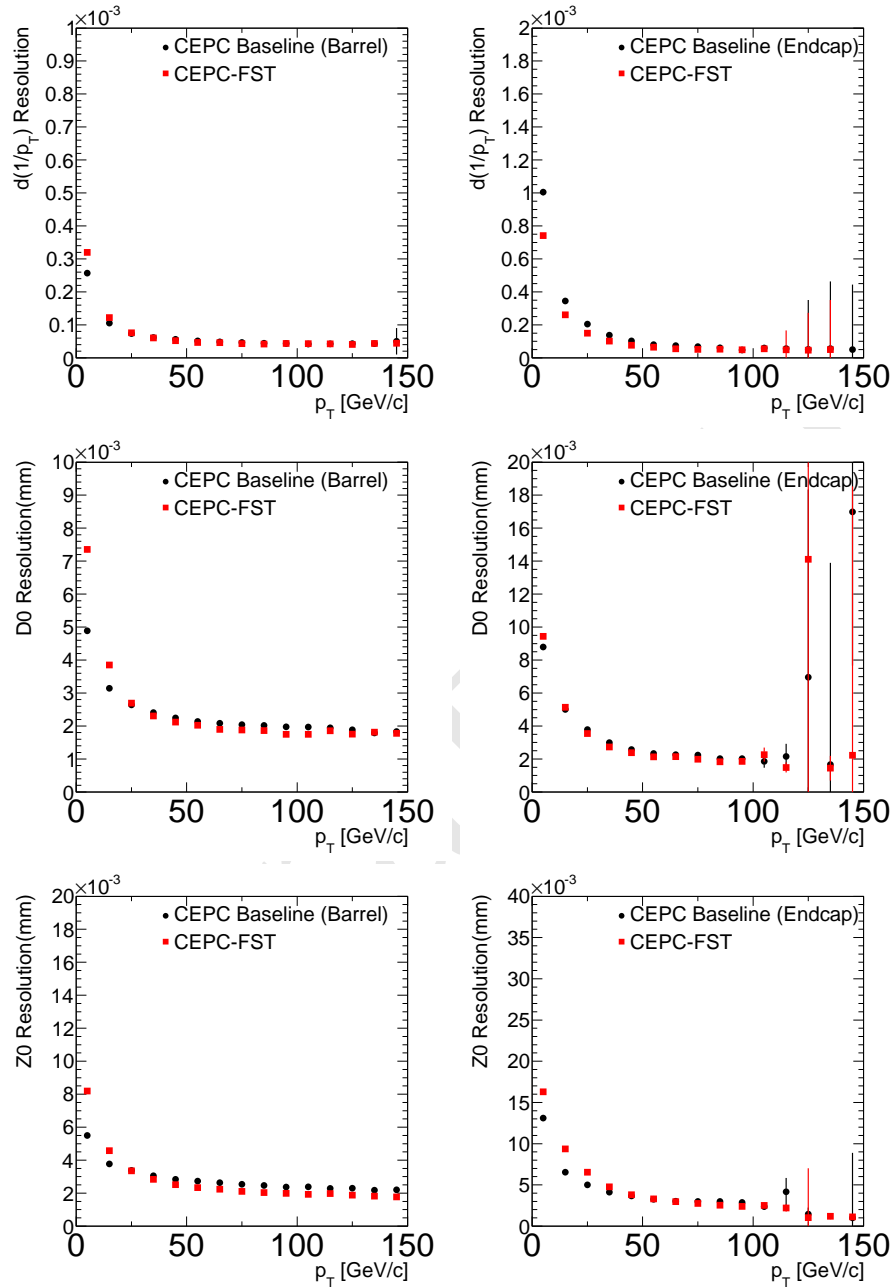

Figure 4.29: The tracking p_T , d_0 , and z_0 resolutions are measured as function of p_T using single muons, left in the barrel region and right in the endcap region. They are compared between CEPC v_4 and CEPC-FST detectors. The resolutions for the low momentum tracks in the CEPC baseline detector seems slightly better than CEPC-FST, due to extra materia in the detector. **Let's make sure the baseline numbers are consistent with what we presented earlier in the baseline subsection!**

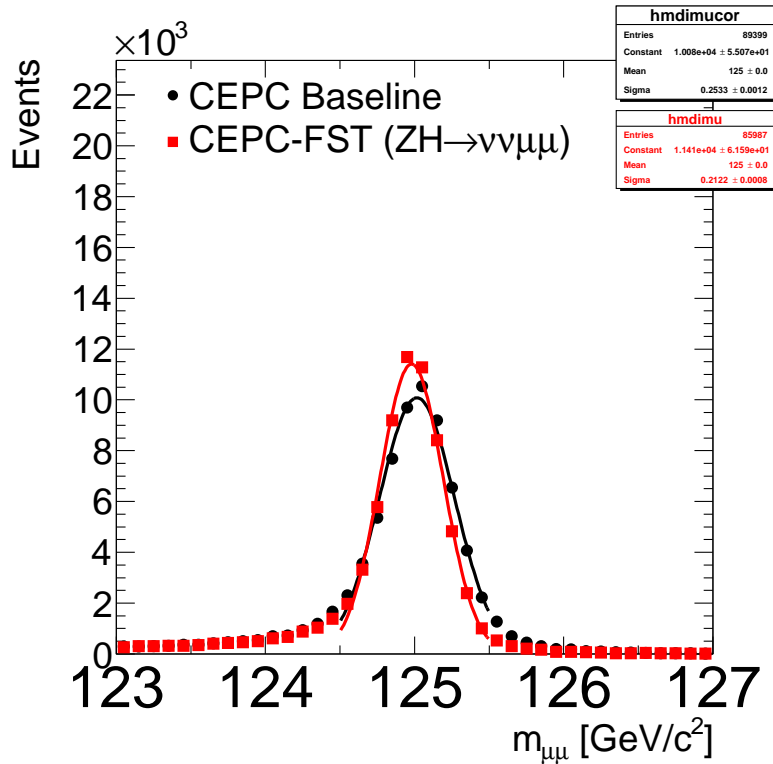

Figure 4.30: The di-muon mass distribution is compared from CEPC baseline and CEPC-FST detectors.

1 directions, this is equivalent to about 5.0% X_0 , including the endplates instrumented with
 2 front end electronics. The high transparency is particularly relevant for precision elec-
 3 troweak physics at the Z pole and for flavour physics, where the average charged particles
 4 momenta are in a range over which the multiple scattering contribution to the momentum
 5 measurement is significant.

6 4.4.2 Overview

7 The DCH is a unique volume, high granularity, all stereo, low mass cylindrical drift cham-
 8 ber, co-axial to the 2 T solenoid field. It extends from an inner radius $R_{in} = 0.35$ m to an
 9 outer radius $R_{out} = 2$ m, for a length $L = 4$ m and consists of 112 co-axial layers, at al-
 10 ternating sign stereo angles (in the range from 50 mrad to 250 mrad), arranged in 24
 11 identical azimuthal sectors. The square cell size (5 field wires per sense wire) varies be-
 12 tween 12.0 and 14.5 mm for a total of 56,448 drift cells. Thanks to the peculiar design of
 13 the wiring procedures, successfully applied to the recent construction of the MEG2 drift
 14 chamber, such a large number of wires poses no particular concern.

15 A system of tie-rods directs the wire tension stress to the outer endplate rim, where
 16 a cylindrical carbon fibre support structure bearing the total load is attached. Two thin
 17 carbon fibre domes, suitably shaped to minimise the stress on the inner cylinder and free to
 18 deform under the gas pressure without affecting the wire tension, enclose the gas volume.

19 The angular coverage, for infinite momentum tracks originated at the interaction point
 20 and efficiently reconstructed in space, extends down to approximately 13° .

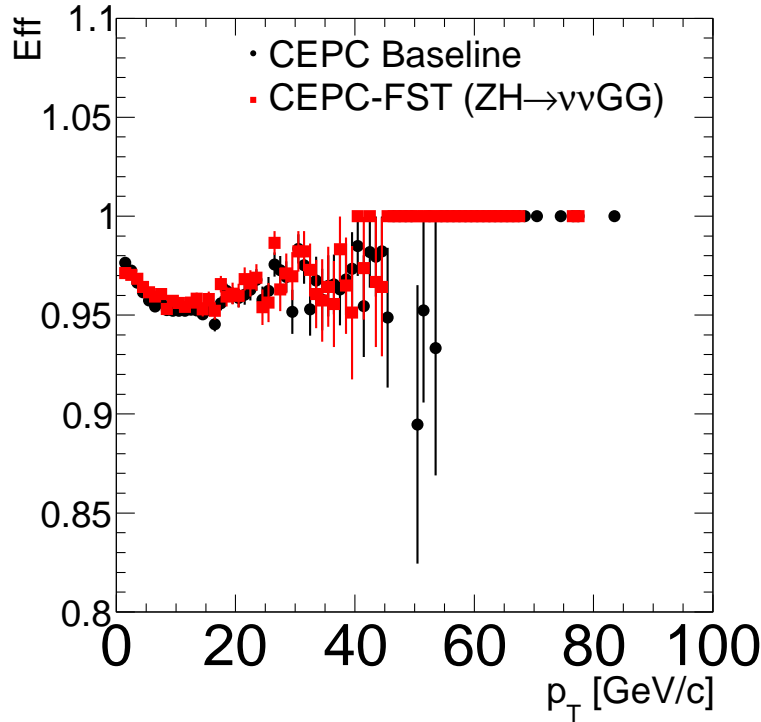

Figure 4.31: The tracking efficiencies for the stable particles inside the gluon jets as function of track p_T with CEPC_v4 and CEPC-FST.

1 In order to facilitate track finding, the sense wires are read out from both ends to allow
2 for charge division and time propagation difference measurements.

3 The chamber is operated with a very light gas mixture, 90%He – 10% iC_4H_{10} , corre-
4 sponding to about 400 ns maximum drift time for the largest cell size. The number of ion-
5 isation clusters generated by a *m.i.p.* in this gas mixture is about 12.5 cm^{-1} , allowing for
6 the exploitation of the cluster counting/timing techniques for improving both spatial reso-
7 lution ($\sigma_x < 100\ \mu\text{m}$) and particle identification ($\sigma(dN_{cluster}/dx)/(dN_{cluster}/dx) \approx 2\%$).

8 4.4.3 Expected performance

9 Figure 4.32 indicates a $100\ \mu\text{m}$ drift distance resolution, averaged over all drift times,
10 measured in a MEG2 drift chamber prototype[47] (7 mm cell size), with very similar
11 electrostatic configuration and gas mixture. A better resolution is expected for DCH,
12 because of the longer drift distances. Cluster timing technique may further improve it.
13 Analytical calculations for the expected transverse momentum and angular resolutions
14 are plotted in Figure 4.33.

15 Based on the assumption that one can, in principle, reach a relative resolution on the
16 measurement of the number of primary ionisation clusters, N_{cl} , equal to $1/\sqrt{N_{cl}}$, the
17 expected performance relative to particle separation in number of units of standard devi-
18 ations is presented in Figure 4.34 as a function of the particle momentum. Solid curves
19 refer to cluster counting technique applied to a 2 m track length with 80% cluster iden-
20 tification efficiency and negligible (a few percent) fake clusters contamination. Dashed

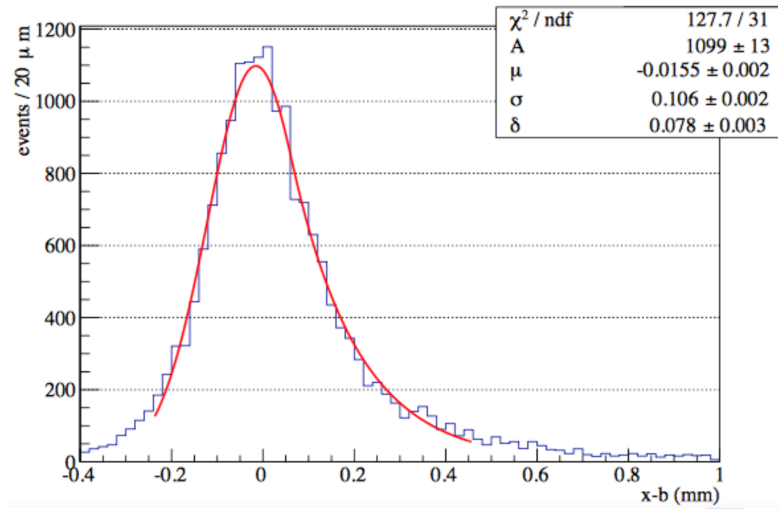

Figure 4.32: Measured drift distance residue distribution in the MEG2 drift chamber prototype under cosmic rays, indicating a resolution of less than $110\mu\text{m}$, averaged over all drift times and in a wide range of track angles. 85% He – 15% iC_4H_{10} gas mixture.

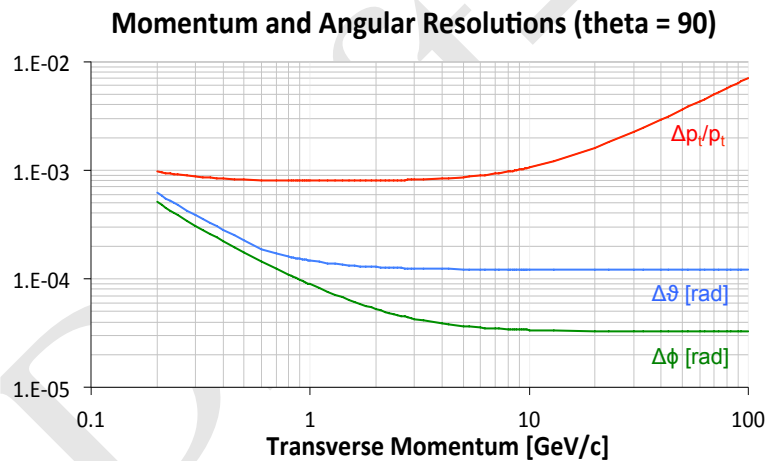

Figure 4.33: Momenta and angular resolutions as a function of the particle momentum for $\theta = 90^\circ$.

1 curves refer to the best theoretical prediction attainable with the dE/dx technique for the
 2 same track length and same number of samples. For the whole range of momenta, particle
 3 separation with cluster counting outperforms dE/dx technique by more than a factor of
 4 two, estimating an expected pion/kaon separation better than three standard deviations for
 5 all momenta below $850\text{ MeV}/c$ and slightly above $1.0\text{ GeV}/c$.

6 4.4.4 Tracking system simulation results

7 For the purpose of optimising the track reconstruction performance, a vertex detector (dif-
 8 ferent from the baseline choice) made of seven cylindrical layers, inside the drift chamber
 9 inner radius, and of five forward disks, has been simulated together with a layer of silicon
 10 microstrip detectors surrounding the drift chamber both in the barrel and in the forward
 11 regions, followed by a pre-shower detector system within a homogeneous $2T$ longitudi-

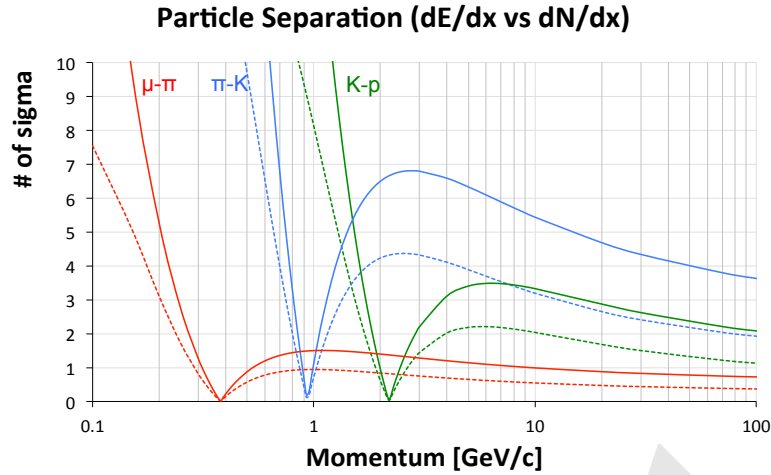

Figure 4.34: Particle type separation in units of standard deviations, with cluster counting (solid lines) and with dE/dx (broken lines) as a function of the particle momentum. A cluster counting efficiency of 80% and a dE/dx resolution of 4.2% have been assumed.

1 nal magnetic field. Details of ionisation clustering for cluster counting/timing analysis
 2 have not been included in the simulations, limiting the drift chamber performance both in
 3 spatial resolution (a $100 \mu\text{m}$ gaussian smeared point resolution has been assumed) and in
 4 particle separation (no dN_{cl}/dx analysis has been simulated). A simplified track finding
 5 algorithm at its preliminary stage of development has been used to feed the space points
 6 to the GenFit2 interface for the ultimate track fit. Figure 4.35 shows the momentum, angle
 7 and impact parameter resolutions obtained by the tracking system simulation. No optimi-
 8 sation has been tried yet. Momentum resolutions $\Delta p/p = 4 \times 10^{-3}$ at $p = 100 \text{ GeV}/c$, for
 9 $\theta = 65^\circ$, and angular resolutions $\leq 0.1 \text{ mrad}$ for $p \geq 10 \text{ GeV}/c$, are within reach. Lastly,
 10 a fit to the bottom right plot in Figure 4.35 gives a d_0 impact parameter resolution:

$$\sigma_{d_0} = a \oplus \frac{b}{p \sin^{3/2} \theta}$$

11 with $a = 3 \mu\text{m}$ and $b = 15 \mu\text{m} \cdot \text{GeV}/c$.

12 4.4.5 Backgrounds in the tracking system

13 Of the main sources of backgrounds in the tracking system: incoherent pair production
 14 (IPC), synchrotron radiation and $\gamma\gamma$ to hadrons, IPC is the dominant one. However, only
 15 very few of the primary e^\pm particles will have a transverse momentum large enough to
 16 reach the inner radius of the drift chamber and the majority of the hits will be generated
 17 by secondary particles (mainly photons of energy below 1 MeV) produced by scattering
 18 off the material at low radii. Based on experience from the very similar MEG2 drift
 19 chamber, which has a smaller number of hits per track and a much more complicated
 20 event topology, occupancies of up to several percent will not affect tracking efficiency and
 21 single track momentum resolution. The level of occupancy here is expected to be even
 22 smaller with the use of the drift chamber timing measurement. As opposed to charged
 23 particles, indeed, that leave a string of ionisation in the drift cells they traverse, photons
 24 are characterised by a localised energy deposition. Signals from photons can therefore be
 25 effectively suppressed at the data acquisition level by requiring that a threshold be reached

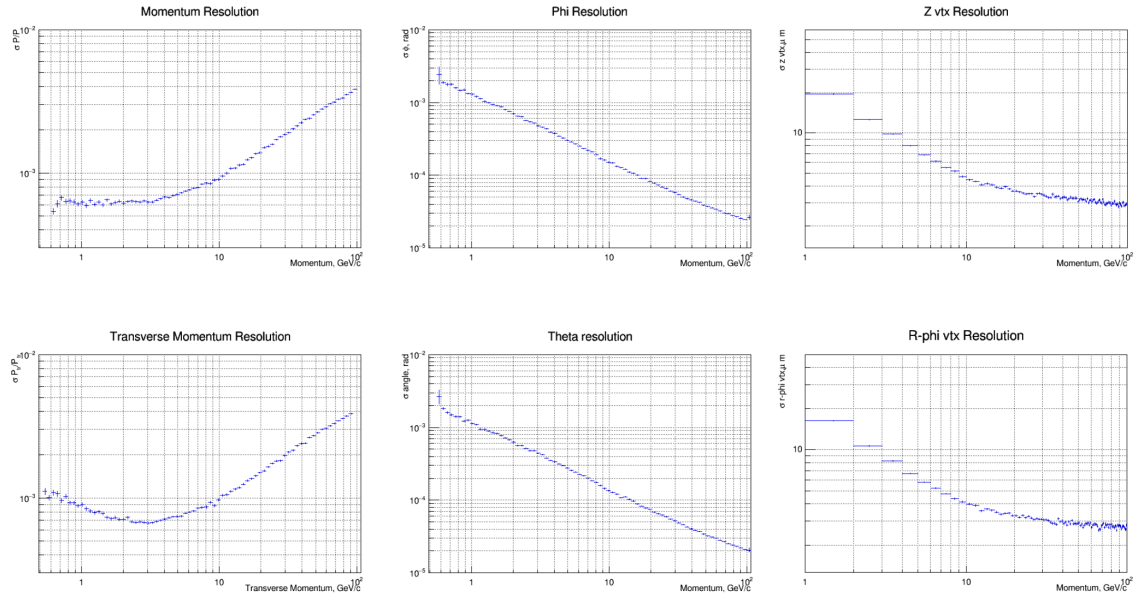

Figure 4.35: Momentum resolutions (top and bottom left), angle resolutions (top and bottom center) and impact parameter resolutions (top and bottom right) from simulation of isolated tracks.

1 by the number of ionisation clusters within a reasonable time window. In addition, charge
 2 strings with holes longer than the average cluster separation can be interpreted as due to
 3 separate signals, thus avoiding piling up of any remaining photon induced background.
 4 With this effective suppression of photon induced signals, the background from IPC is
 5 expected to remain low and is unlikely to cause adverse issues for the track reconstruction.

6 4.4.6 Constraints on the readout system

7 With a drift chamber, all digitised hits generated at the occurrence of a trigger are usually
 8 transferred to data storage. The IDEA drift chamber transfers 2 B/ns from both ends of
 9 all wires hit, over a maximum drift time of 400 ns. With 20 tracks/event and 130 cells
 10 hit for each track, the size of a hadronic Z decay in the DCH is therefore about 4 MB,
 11 corresponding to a bandwidth of 40 GB/s at the Z pole (at a trigger rate of approximately
 12 10 KHz). The contribution from $\gamma\gamma$ to hadrons amounts to 6 GB/s. As mentioned in
 13 the previous paragraph, the IPC background causes the read-out of additional 1400 wires
 14 on average for every trigger, which translates into a bandwidth of 25 GB/s. A similar
 15 bandwidth is taken by the noise induced by the low single electron detection threshold
 16 necessary for an efficient cluster counting. Altogether, the various contributions sum up
 17 to a data rate of about 0.1 TB/s. Reading out these data and sending them into an "event
 18 builder" would not be a challenge, but the data storage requires a large reduction. Such a
 19 reduction can be achieved by transferring, for each hit drift cell, the minimal information
 20 needed by the cluster timing/counting, i.e., the amplitude and the arrival time of each peak
 21 associated with each individual ionisation electron, each encoded in 1 Byte, instead of the
 22 full signal spectrum. The data generated by the drift chamber, subsequently digitised
 23 by an ADC, can be analysed in real time by a fast read-out algorithm implemented in a
 24 FPGA[48]. This algorithm identifies, in the digitised signal, the peaks corresponding to

1 the different ionisation electrons, stores the amplitude and the time for each peak in an
 2 internal memory, filters out spurious and isolated hits and sends these reduced data to the
 3 acquisition system at the occurrence of a trigger. Each hit cell integrates the signal of up
 4 to 30 ionisation electrons, which can thus be encoded within 60 B per wire end instead of
 5 the aforementioned 800 B. Because the noise and background hits are filtered out by the
 6 FPGA algorithm, the data rate induced by Z hadronic decays is reduced to 3 GB/s, for a
 7 total bandwidth of about 3.6 GB/s, roughly a factor 30 reduction.

8 References

- 9 [1] P. M. De Freitas and H. Videau, *Detector simulation with MOKKA/GEANT4:*
 10 *Present and future*, in *International Workshop on Linear Colliders (LCWS 2002)*,
 11 *Jeju Island, Korea*, pp. 26–30. 2002.
- 12 [2] M. Regler, M. Valentan, and R. Frühwirth, *The LiC detector toy program*, Nuclear
 13 *Instruments and Methods in Physics Research Section*
 14 *A:Accelerators,Spectrometers,Detectors and Associated Equipment* **581** (2007)
 15 no. 1, 553–556.
- 16 [3] M. Battaglia, C. Da Viá, D. Bortoletto, R. Brenner, M. Campbell, P. Collins,
 17 G. Dalla Betta, M. Demarteau, P. Denes, H. Graafsma, et al., *R&D paths of pixel*
 18 *detectors for vertex tracking and radiation imaging*, Nuclear Instruments and
 19 *Methods in Physics Research Section A:Accelerators,Spectrometers,Detectors and*
 20 *Associated Equipment* **716** (2013) 29–45.
- 21 [4] G. Contin, E. Anderssen, L. Greiner, J. Schambach, J. Silber, T. Stezelberger,
 22 X. Sun, M. Szelezniak, C. Vu, H. Wieman, et al., *The MAPS based PXL vertex*
 23 *detector for the STAR experiment*, *Journal of Instrumentation* **10** (2015) no. 03,
 24 C03026.
- 25 [5] C. Lacasta, *The DEPFET pixel detector for the Belle II experiment at SuperKEKB*,
 26 *PoS* (2014) 005.
- 27 [6] B. Abelev, J. Adam, D. Adamova, M. Aggarwal, G. A. Rinella, M. Agnello,
 28 A. Agostinelli, N. Agrawal, Z. Ahammed, N. Ahmad, et al., *Technical design report*
 29 *for the upgrade of the ALICE inner tracking system*, *Journal of Physics G: Nuclear*
 30 *and Particle Physics* **41** (2014) no. 8, .
- 31 [7] I. Valin, C. Hu-Guo, J. Baudot, G. Bertolone, A. Besson, C. Colledani, G. Claus,
 32 A. Dorokhov, G. DoziÅšre, W. Dulinski, M. Gelin, M. Goffe, A. Himmi,
 33 K. Jaaskelainen, F. Morel, H. Pham, C. Santos, S. Senyukov, M. Specht,
 34 G. Voutsinas, J. Wang, and M. Winter, *A reticle size CMOS pixel sensor dedicated*
 35 *to the STAR HFT*, *Journal of Instrumentation* **7** (2012) no. 01, C01102.
 36 <http://stacks.iop.org/1748-0221/7/i=01/a=C01102>.
- 37 [8] G. A. Rinella, *The ALPIDE pixel sensor chip for the upgrade of the ALICE Inner*
 38 *Tracking System*, *Nuclear Instruments and Methods in Physics Research Section A:*
 39 *Accelerators, Spectrometers, Detectors and Associated Equipment* **845** (2017) 583
 40 –587. <http://www.sciencedirect.com/science/article/pii/>

- 1 S0168900216303825. Proceedings of the Vienna Conference on
2 Instrumentation 2016.
- 3 [9] Y. Lu, Q. Ouyang, Y. Arai, Y. Liu, Z. Wu, and Y. Zhou, *First results of a*
4 *Double-SOI pixel chip for X-ray imaging*, *Nuclear Instruments and Methods in*
5 *Physics Research Section A: Accelerators, Spectrometers, Detectors and Associated*
6 *Equipment* **831** (2016) 44 – 48. <http://www.sciencedirect.com/science/article/pii/S0168900216301851>. Proceedings of the 10th
7 International Hiroshima Symposium on the Development and Application of
8 Semiconductor Tracking Detectors.
- 10 [10] I. Kurachi, K. Kobayashi, M. Mochizuki, M. Okihara, H. Kasai, T. Hatsui, K. Hara,
11 T. Miyoshi, and Y. Arai, *Tradeoff Between Low-Power Operation and Radiation*
12 *Hardness of Fully Depleted SOI pMOSFET by Changing LDD Conditions*, *IEEE*
13 *Transactions on Electron Devices* **63** (2016) no. 6, 2293–2298.
- 14 [11] Z. Wu, *A prototype SOI pixel sensor for CEPC vertex*,
15 [https://indico.cern.ch/event/577879/contributions/](https://indico.cern.ch/event/577879/contributions/2741627/attachments/1575067/2486910/A_prototype_SOI_pixel_sensor_for_CEPC_vertex.pdf)
16 [2741627/attachments/1575067/2486910/A_prototype_SOI_](https://indico.cern.ch/event/577879/contributions/2741627/attachments/1575067/2486910/A_prototype_SOI_pixel_sensor_for_CEPC_vertex.pdf)
17 [pixel_sensor_for_CEPC_vertex.pdf](https://indico.cern.ch/event/577879/contributions/2741627/attachments/1575067/2486910/A_prototype_SOI_pixel_sensor_for_CEPC_vertex.pdf).
- 18 [12] S. Ono, M. Togawa, R. Tsuji, T. Mori, M. Yamada, Y. Arai, T. Tsuboyama, and
19 K. Hanagaki, *Development of a pixel sensor with fine space-time resolution based*
20 *on SOI technology for the ILC vertex detector*, *Nuclear Instruments and Methods in*
21 *Physics Research Section A: Accelerators, Spectrometers, Detectors and Associated*
22 *Equipment* **845** (2017) 139 – 142. [http://www.sciencedirect.com/](http://www.sciencedirect.com/science/article/pii/S0168900216303783)
23 [science/article/pii/S0168900216303783](http://www.sciencedirect.com/science/article/pii/S0168900216303783). Proceedings of the Vienna
24 Conference on Instrumentation 2016.
- 25 [13] M. Idzik, *SOI-Cracow*, [https://](https://agenda.linearcollider.org/event/7450/contributions/38595/attachments/31561/47538/2017_LCVertex_Idzik.pdf)
26 [agenda.linearcollider.org/event/7450/contributions/](https://agenda.linearcollider.org/event/7450/contributions/38595/attachments/31561/47538/2017_LCVertex_Idzik.pdf)
27 [38595/attachments/31561/47538/2017_LCVertex_Idzik.pdf](https://agenda.linearcollider.org/event/7450/contributions/38595/attachments/31561/47538/2017_LCVertex_Idzik.pdf).
- 28 [14] S. Spannagel, *Silicon technologies for the CLIC vertex detector*, *Journal of*
29 *Instrumentation* **12** (2017) no. 06, C06006.
30 <http://stacks.iop.org/1748-0221/12/i=06/a=C06006>.
- 31 [15] H. Wieman, E. Anderssen, L. Greiner, H. Matis, H. Ritter, X. Sun, and
32 M. Szelezniak, *STAR PIXEL detector mechanical design*, *Journal of*
33 *Instrumentation* **4** (2009) no. 05, P05015.
- 34 [16] H. Abramowicz et al., *The International Linear Collider Technical Design Report -*
35 *Volume 4: Detectors*, [arXiv:1306.6329](https://arxiv.org/abs/1306.6329) [[physics.ins-det](https://arxiv.org/abs/1306.6329)].
- 36 [17] Belle-II Collaboration, T. Abe et al., *Belle II Technical Design Report*,
37 [arXiv:1011.0352](https://arxiv.org/abs/1011.0352) [[physics.ins-det](https://arxiv.org/abs/1011.0352)].
- 38 [18] Y. Zhang, H. Zhu, L. Zhang, and M. Fu, *Charge collection and non-ionizing*
39 *radiation tolerance of CMOS pixel sensors using a 0.18 μm CMOS process*,
40 *Nuclear Instruments and Methods in Physics Research Section A: Accelerators,*
41 *Spectrometers, Detectors and Associated Equipment* **831** (2016) 99 – 104.

- 1 <http://www.sciencedirect.com/science/article/pii/S0168900216300481>. Proceedings of the 10th International Hiroshima
2 Symposium on the Development and Application of Semiconductor Tracking
3 Detectors.
4
- 5 [19] Y. Zhou, *Development of highly compact digital pixels for the vertex detector of the*
6 *future e+e- collider*, [https://](https://indico.cern.ch/event/577879/contributions/2740073/)
7 indico.cern.ch/event/577879/contributions/2740073/.
- 8 [20] Y. Zhang, *A Monolithic Active Pixel Sensor prototype for the CEPC vertex detector*,
9 [https://](https://indico.cern.ch/event/577879/contributions/2740125/attachments/1574470/2485730/P15_ZY_POSTER_Final.pdf)
10 [indico.cern.ch/event/577879/contributions/2740125/](https://indico.cern.ch/event/577879/contributions/2740125/attachments/1574470/2485730/P15_ZY_POSTER_Final.pdf)
11 [attachments/1574470/2485730/P15_ZY_POSTER_Final.pdf](https://indico.cern.ch/event/577879/contributions/2740125/attachments/1574470/2485730/P15_ZY_POSTER_Final.pdf).
- 12 [21] Y. Lu, *Study of SOI Pixel for the Vertex*,
13 <http://indico.ihep.ac.cn/event/6433/>.
- 14 [22] M. Motoyoshi, T. Miyoshi, M. Ikebec, and Y. Arai, *3D integration technology for*
15 *sensor application using less than 5 μ m-pitch gold cone-bump connpdfection*,
16 *Journal of Instrumentation* **10** (2015) no. 03, C03004.
17 <http://stacks.iop.org/1748-0221/10/i=03/a=C03004>.
- 18 [23] W. Snoeys, G. A. Rinella, H. Hillemanns, T. Kugathasan, M. Mager, L. Musa,
19 P. Riedler, F. Reidt, J. V. Hoorne, A. Fenigstein, and T. Leitner, *A process*
20 *modification for CMOS monolithic active pixel sensors for enhanced depletion,*
21 *timing performance and radiation tolerance*, *Nuclear Instruments and Methods in*
22 *Physics Research Section A: Accelerators, Spectrometers, Detectors and Associated*
23 *Equipment* **871** (2017) 90–96. [http://www.sciencedirect.com/](http://www.sciencedirect.com/science/article/pii/S016890021730791X)
24 [science/article/pii/S016890021730791X](http://www.sciencedirect.com/science/article/pii/S016890021730791X).
- 25 [24] F. Shen, S. Wang, C. Yang, and Q. Xu, *MWPC prototyping and testing for STAR*
26 *inner TPC upgrade*, *JINST* **12** (2017) no. 06, C06008.
- 27 [25] ALICE Collaboration, D. Rohr, *Tracking performance in high multiplicities*
28 *environment at ALICE*, in *5th Large Hadron Collider Physics Conference (LHCP*
29 *2017) Shanghai, China, May 15-20, 2017*. 2017. [arXiv:1709.00618](https://arxiv.org/abs/1709.00618)
30 [\[physics.ins-det\]](https://arxiv.org/abs/1709.00618).
31 [https://inspirehep.net/record/1621494/files/arXiv:](https://inspirehep.net/record/1621494/files/arXiv:1709.00618.pdf)
32 [1709.00618.pdf](https://inspirehep.net/record/1621494/files/arXiv:1709.00618.pdf).
- 33 [26] P. Bhattacharya, S. S. Sahoo, S. Biswas, B. Mohanty, N. Majumdar, and
34 S. Mukhopadhyay, *Numerical Investigation on Electron and Ion Transmission of*
35 *GEM-based Detectors*, *EPJ Web Conf.* **174** (2018) 06001.
- 36 [27] M. Posik and B. Surrow, *Construction of a Triple-GEM Detector Using*
37 *Commercially Manufactured Large GEM Foils*, 2018. [arXiv:1806.01892](https://arxiv.org/abs/1806.01892)
38 [\[physics.ins-det\]](https://arxiv.org/abs/1806.01892).
- 39 [28] ATLAS Muon Collaboration, D. Sampsonidis, *Study of the performance of*
40 *Micromegas detectors in magnetic field*, *EPJ Web Conf.* **174** (2018) 05003.

- 1 [29] S. Dalla Torre, E. Oliveri, L. Ropelewski, and M. Titov, *R&D Proposal: RD51*
2 *Extension Beyond 2018*, [arXiv:1806.09955](https://arxiv.org/abs/1806.09955) [[physics.ins-det](https://arxiv.org/archive/physics)].
- 3 [30] M. Zhao, M. Ruan, H. Qi, and Y. Gao, *Feasibility study of TPC at electron positron*
4 *colliders at Z pole operation*, *JINST* **12** (2017) no. 07, P07005,
5 [arXiv:1704.04401](https://arxiv.org/abs/1704.04401) [[physics.ins-det](https://arxiv.org/archive/physics)].
- 6 [31] A. Affolder et al., *DC-DC converters with reduced mass for trackers at the*
7 *HL-LHC*, *JINST* **6** (2011) C11035.
- 8 [32] S. Diez, *System Implications of the Different Powering Distributions for the ATLAS*
9 *Upgrade Strips Tracker*, *Phys.Procedia* **37** (2012) 960–969.
- 10 [33] K. Klein et al., *DC-DC conversion powering schemes for the CMS tracker at*
11 *Super-LHC*, *JINST* **5** (2010) C07009.
- 12 [34] A. Nomerotski et al., *Evaporative CO2 cooling using microchannels etched in*
13 *silicon for the future LHCb vertex detector*, *JINST* **8** (2013) P04004,
14 [arXiv:1211.1176](https://arxiv.org/abs/1211.1176) [[physics.ins-det](https://arxiv.org/archive/physics)].
- 15 [35] The ATLAS Collaboration, A. Affolder, *Silicon Strip Detectors for the ATLAS*
16 *HL-LHC Upgrade*, *Phys.Procedia* **37** (2012) 915–922.
- 17 [36] V. Blobel, *Software alignment for tracking detectors*, *Nucl.Instrum.Meth.* **A566**
18 (2006) 5–13.
- 19 [37] A. Savoy-Navarro, *Large Area Silicon Tracking: New Perspectives*,
20 [arXiv:1203.0736](https://arxiv.org/abs/1203.0736) [[physics.ins-det](https://arxiv.org/archive/physics)].
- 21 [38] N. Calace and A. Salzburger, *ATLAS Tracking Detector Upgrade studies using the*
22 *Fast Simulation Engine*, *J. Phys.:Conf. Ser.* **664** (2015) 072005.
- 23 [39] M. Regler et al., *The LiC Detector Toy program*, *J. Phys.:Conf. Ser.* **119** (2008)
24 032034.
- 25 [40] N. Graf and J. McCormick, *LCSIM: A detector response simulation toolkit*, in *2012*
26 *IEEE Nuclear Science Symposium and Medical Imaging Conference Record*
27 *(NSS/MIC)*, p. 1016. Oct, 2012.
- 28 [41] C. Adolphsen et al., *The International Linear Collider Technical Design Report -*
29 *Volume 3. II: Accelerator Baseline Design*, 2013. [arXiv:1306.6328](https://arxiv.org/abs/1306.6328)
30 [[physics.acc-ph](https://arxiv.org/archive/physics)].
- 31 [42] H. Abramowicz et al., *The International Linear Collider Technical Design Report -*
32 *Volume 4: Detectors*, 2013. [arXiv:1306.6329](https://arxiv.org/abs/1306.6329) [[physics.ins-det](https://arxiv.org/archive/physics)].
- 33 [43] M. J. Charles, *PFA Performance for SiD*, in *Linear colliders. Proceedings,*
34 *International Linear Collider Workshop, LCWS08, and International Linear*
35 *Collider Meeting, ILC08, Chicago, USA, November 16-20, 2008*. 2009.
36 [arXiv:0901.4670](https://arxiv.org/abs/0901.4670) [[physics.data-an](https://arxiv.org/archive/physics)].
- 37 [44] J. S. Marshall and M. A. Thomson, *Pandora Particle Flow Algorithm*, in
38 *Proceedings, International Conference on Calorimetry for the High Energy*

- 1 *Frontier (CHEF 2013)*, pp. 305–315. 2013. [arXiv:1308.4537](#)
2 [\[physics.ins-det\]](#).
- 3 [45] M. Adinolfi et al., *The tracking detector of the KLOE experiment*, *Nucl. Instrum.*
4 *Meth. A***488** (2002) 51–73.
- 5 [46] A. M. Baldini et al., *MEG Upgrade Proposal*, [arXiv:1301.7225](#)
6 [\[physics.ins-det\]](#).
- 7 [47] A. M. Baldini et al., *Single-hit resolution measurement with MEG II drift chamber*
8 *prototypes*, [arXiv:1605.07970](#) [\[physics.ins-det\]](#).
- 9 [48] G. Chiarello, C. Chiri, G. Cociolo, A. Corvaglia, F. Grancagnolo, M. Panareo,
10 A. Pepino, and G. F. Tassielli, *The Use of FPGA in Drift Chambers for High Energy*
11 *Physics Experiments*, 2017.
12 <http://inspirehep.net/record/1663851/files/53616.pdf>.

CHAPTER 5

CALORIMETRY

1 5.1 Introduction to calorimeters

2 A calorimetry system is employed in the CEPC detector to provide hermetic coverage
3 for high-resolution energy measurements of electrons, photons, taus and hadronic jets.
4 To fully exploit the potential of the CEPC physics program for Higgs and electroweak
5 physics, all possible final states from decays of the intermediate vector bosons, W and Z,
6 and the Higgs boson need to be separately identified and reconstructed with high sensitiv-
7 ity. In particular, to clearly discriminate the $H \rightarrow ZZ^* \rightarrow 4j$ and $H \rightarrow WW^* \rightarrow 4j$ final
8 states, the energy resolution of the CEPC calorimetry system for hadronic jets needs to be
9 pushed quite beyond today's limits. Indeed, in order to distinguish the hadronic decays of
10 W and Z bosons, a 3%-4% invariant mass resolution for two-jet systems is required. Such
11 a performance needs a jet energy resolution of $\sim 30\%/\sqrt{E}$, at energies below 100 GeV.
12 This would be about a factor of two better than that provided by the LEP detectors and the
13 currently operating calorimeters at the LHC, and would significantly improve the separa-
14 tion of the W and Z bosons in their hadronic decays, as shown in Figure 5.1. Two different
15 technology approaches are pursued for the CEPC calorimetry system, the first one aiming
16 to measure individual particles in a jet using a calorimetry system with very high granu-
17 larity based on the particle flow concept, while the second aiming at a homogeneous and
18 integrated solution based on the dual-readout concept. Both approaches will be described
19 in this chapter, while the first approach is the current baseline for the design of the CEPC
20 calorimetry system in that it is integrated in the full CEPC detector simulation.

21
22 The particle flow algorithm (PFA [1]) is a very promising approach to achieve the un-
23 precedented jet energy resolution of 3%-4%. The basic idea of the PFA is to make use

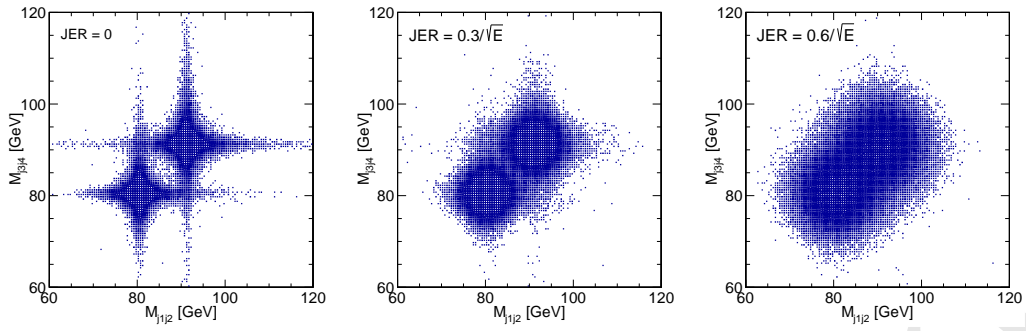

Figure 5.1: Separation of W and Z bosons in their hadronic decays with different jet energy resolutions: $0/\sqrt{E}$ (left), $30\%/\sqrt{E}$ (middle), and $60\%/\sqrt{E}$ (right). A jet energy resolution of $30\%/\sqrt{E}$ is required to separate the hadronic decays of W and Z bosons.

1 of the optimal sub-detector in a detector system to determine the energy/momentum of
 2 each particle in a jet. An essential prerequisite for realization of this idea is to distinguish
 3 among energy deposits of individual particles from a jet in the calorimetry system. High,
 4 three-dimensional spatial granularity is required for the calorimetry system to achieve this.
 5 Therefore, PFA calorimeters feature finely segmented, three-dimensional granularity and
 6 compact, spatially separated, particle showers to facilitate the reconstruction and identifica-
 7 tion of every single particle shower in a jet. It is for this feature PFA calorimeters are
 8 usually also called imaging calorimeters. A PFA calorimetry system generally consists
 9 of an electromagnetic calorimeter (ECAL), optimized for measurements of photons and
 10 electrons, and a hadronic calorimeter (HCAL) to measure hadronic showers.

11 In a typical jet, 65% of its energy is carried by charged particles, 25% by photons and
 12 10% by neutral hadrons. The charged particles in a jet can be precisely measured with
 13 a tracking system, especially for low momentum particles where the relatively small,
 14 multiple scattering term dominates in the resolution, and their tracks can be matched
 15 to their energy deposits in a PFA calorimetry system. This combination maximizes the
 16 overall resolution of the jet energy measurement by compensating for the worsening of
 17 calorimeter-only energy resolution for low energy particles by leveraging the improved
 18 resolution from the tracking system. Energy deposits in the PFA calorimetry system with-
 19 out matched tracks are considered to originate from the neutral particles of photons and
 20 neutral hadrons in the jet. Among these neutral particles, photons are measured using the
 21 ECAL with good energy resolution, while only the neutral hadrons are primarily measured
 22 using a combination of the ECAL and HCAL with a limited energy resolution. Therefore,
 23 in the PFA, the jet energy is determined by combining the best measurement in a detector
 24 system of each single particle in the jet: the track momenta of charged particles measured
 25 using the tracking system, the energies of photons measured using the ECAL and the
 26 energies of neutral hadrons measured primarily using the HCAL.

27 Extensive studies have been carried out within the CALICE collaboration [2] to devel-
 28 op compact PFA calorimeters. Various detector technology options have been explored
 29 to address challenges from stringent performance requirements as shown in Figure 5.2.
 30 Prototypes with high granularity using several technological options have been developed
 31 and exposed to particle beams, which have demonstrated the in-depth understanding of
 32 the PFA calorimetry performance.

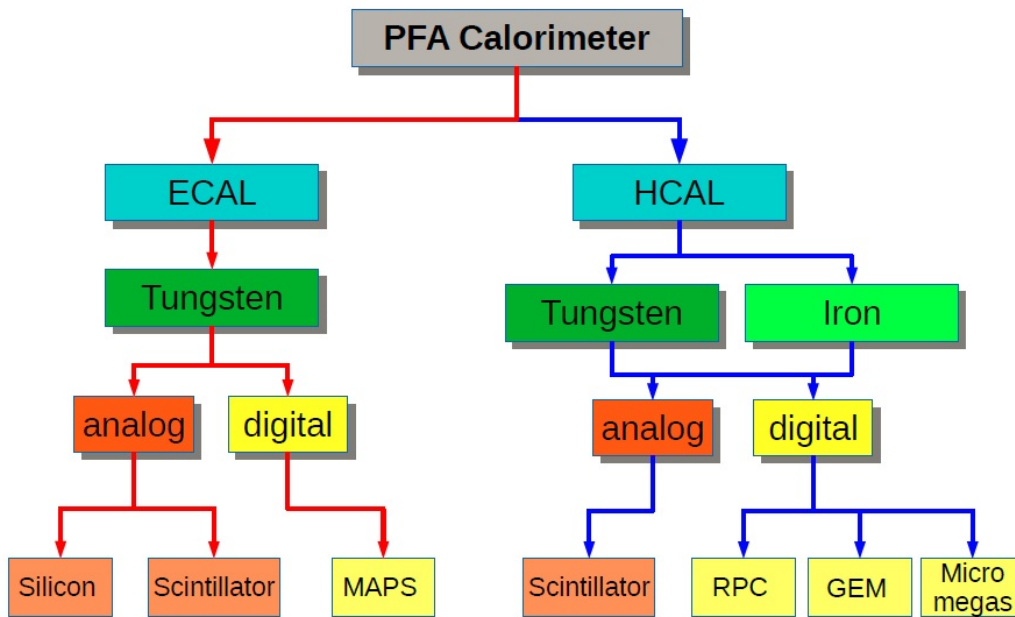

Figure 5.2: PFA: Overview of development of imaging calorimeters in the CALICE collaboration. Various technology options have been explored in aspects including absorber material, active medium and readout scheme.

1 An alternative approach for a combined, high-performance, electromagnetic and hadronic
 2 calorimeter aims at reaching an even better (standalone) hadronic resolution, without
 3 spoiling the electromagnetic one, by exploiting the dual-readout (DR) technique. Indeed
 4 the main limiting factor to the energy resolution in hadron calorimetry arises from the fluc-
 5 tuations of the electromagnetic component (f_{em}) that each hadronic shower develops as
 6 consequence of π^0 and η production. Since typically the detector response to the hadronic
 7 and em components is very different ($h/e \neq 1$), the reconstructed signal heavily depends
 8 on the actual value of f_{em} . By using two independent processes (namely, scintillation and
 9 Čerenkov light production) that have a very different sensitivity to the hadronic and em
 10 components, it is possible to reconstruct f_{em} , event by event, and eliminate the effects of
 11 its fluctuations.

12 Among the possible DR implementations, a fiber-sampling DR calorimeter, based on
 13 either copper or lead as absorber material, looks the most suitable to provide the required
 14 performance in a cost-effective way. Preliminary results of GEANT4 simulations point to
 15 possible resolutions better than 15% and around 30% – 40% (over \sqrt{E}), for electromag-
 16 netic and hadronic showers, respectively (see Section 5.5.6).

17 Moreover, if the fibers are readout with Silicon PhotoMultipliers (SiPMs), the high de-
 18 tector granularity and the possibility of longitudinal segmentation will make this solution
 19 easily compatible with Particle Flow Algorithms.

20 In the following sections, several possible concrete implementations of a calorimeter
 21 system are discussed in sufficient detail to describe the readiness of the technologies and
 22 the performance of these systems in current test beams and prototypes and their corre-
 23 sponding general implementation in the simulation performance studies of the physics
 24 objects and benchmarks presented in subsequent chapters.

5.2 General design considerations for the PFA Calorimetry system

The CEPC PFA calorimetry system is longitudinally composed of two separate sampling calorimeters: ECAL and HCAL, both of which are installed inside the solenoid coil of the CEPC detector system to minimize the inactive material in front of the calorimetry system and to reliably associate tracks to energy deposits. Following the geometry of the CEPC detector, each of two calorimeters is organised into one cylindrical barrel and two disk-like end-cap sections.

The ECAL, considered here, has analog readout, consisting of sensitive layers of either silicon pads or scintillator tiles interleaved with tungsten absorber plates. As for the HCAL, steel plates are adopted as absorber, and both digital and analog readout is considered. The digital HCAL (DHCAL) uses either Glass Resistive Plate Chambers (GRPC) or Thick Gas Electron Multiplier detectors (THGEM) as the active medium, while the analog HCAL (AHCAL) uses scintillator tiles coupled to SiPMs.

The calorimeters for these options are all highly segmented both transversely and longitudinally, which is driven by the requirement from the particle flow algorithm of excellent particle shower separation capability. The baseline technology options for the CEPC PFA ECAL and HCAL that have been integrated into the full CEPC detector simulation are silicon-tungsten and steel-GRPC, respectively.

In the baseline designs of the calorimeters, the ECAL is segmented into 30 longitudinal layers with a total thickness of tungsten of 84 mm (corresponding to a total depth of $24 X_0$), and the silicon plate in each layer is 0.5 mm thick, divided into square cells each of $10 \times 10 \text{ mm}^2$. The 30 ECAL layers are split into 2 sections with different thickness of absorber layers. The first section contains 20 layers of 2.1 mm thick tungsten plates and the second contains 10 layers of 4.2 mm tungsten plates (see section 5.3.2.2 for details). The HCAL consists of 40 longitudinal layers each containing 2 cm thick steel with a thin layer of GRPCs read out in a cell size of $10 \times 10 \text{ mm}^2$. The above design parameters of both the ECAL and HCAL are a result of dedicated optimization studies based on simulation that will be presented in the subsequent sections.

5.3 Electromagnetic Calorimeter for Particle Flow Approach

The particle flow paradigm has tremendous impact on the design of the ECAL. With excellent capability of pattern recognition, the ECAL is expected to identify photons from close-by showers, reconstruct detailed properties of a shower (i.e. shower shape, starting point and energy distribution), and distinguish electromagnetic showers from hadronic ones. Thus, shower imaging capability of the calorimeter is more important than its intrinsic energy resolution, although the latter is still important to the particle flow performance for electrons, photons and jets. Due to the fact that about half of hadronic showers start inside the ECAL, excellent three dimensional granularity is of primary importance to the ECAL. In order to have the power of separating close-by showers in the calorimeter, absorber material with small Moliere radius is required for the ECAL. And a large ratio of the interaction length over the radiation length of the absorber material is advantageous to separation between electromagnetic and hadronic showers because a short radiation length makes an electromagnetic shower start early in the ECAL, while a long interaction length reduces the fraction of a hadronic shower in the ECAL. A short radiation length also makes a compact ECAL, which is highly desirable from the cost saving point of view.

In short, requirements for the ECAL on high granularity, compactness and shower separation lead to the choice of a sampling calorimeter with tungsten (the radiation length $X_0 = 3.5$ mm, the Molière Radius=9 mm and the interaction length $\lambda_I = 99$ mm) as absorber material. This ensures a compact ECAL with a sufficient depth to contain high-energy showers.

Two options for active material are considered for the ECAL: silicon and scintillator. The silicon option is taken as the baseline, while the scintillator option is also being investigated as alternative. Both options are presented in this section.

5.3.1 Design Optimization

ECAL design parameters including total thickness of absorber, thickness and transversal size of silicon sensors, number of sampling layers have been optimised based on simulation with a simplified and standalone ECAL geometry. There is no material in front of the ECAL and no gaps or dead area between modules in this geometry. In addition, all absorber layers adopt the same thickness and the same is for all sensitive layers.

The Higgs mass resolution in the $\nu\nu H(\rightarrow \gamma\gamma)$ process was used as a figure of merit in optimising the total thickness of absorber. The total thickness of absorber was scanned by coherently varying the thickness of each absorber layer at a very fine step for the Higgs mass resolution performance. The number of sampling layers was fixed to 30 in the scanning and the thickness of silicon sensors was fixed to 0.5 mm. The result from the scanning is shown in Figure 5.3. The best Higgs mass resolution is achieved when the total thickness of tungsten absorber is 84 mm. The number of sampling layers was then varied with the total thickness of absorber fixed to 84 mm, and the energy resolution for single photons was examined as a function of photon energy for different numbers of sampling layers as shown in Figure 5.4(left). The energy resolution degrades by 11% and 26% when the number of sampling layers is reduced from 30 to 25 and 20, respectively. However, such degradation in energy resolution can be compensated by increasing the thickness of silicon sensors. As shown in Figure 5.4(right), the ECAL energy resolution for 20 (25) layers with 1.5 mm (1 mm) thick silicon sensors is about the same as that for 30 layers with 0.5 mm thick silicon sensors. Considering potential challenges in use of very thick silicon sensors, 0.5 mm was chosen as the thickness of silicon sensors. As indicated in Figure 5.4(left), to preserve a good energy resolution, a reasonably large number of sampling layers is required for the ECAL with relatively thin silicon sensors. And it is about 30 for 0.5 mm thick silicon sensors.

In the ECAL baseline design, silicon sensors are in square shape, and the transversal size of silicon sensors is a very critical parameter given its significant impact on the shower separation power as well as the number of readout channels of the ECAL. The latter has strong implications on both the cost and power consumption of the ECAL. It is highly desirable to have a large sensor size to reduce the number of readout channels as long as physics performance of the ECAL is not significantly compromised in the context of the CEPC. The sensor size is not expected to have significant effect on photon energy resolution, and its relevance to the performance of the ECAL is primarily on the shower separation power of the ECAL, which could be severely compromised due to a large sensor size. So the sensor size was optimised in two performance aspects: Higgs boson mass resolution in Higgs hadronic decays and capability of identifying photons from close-by showers.

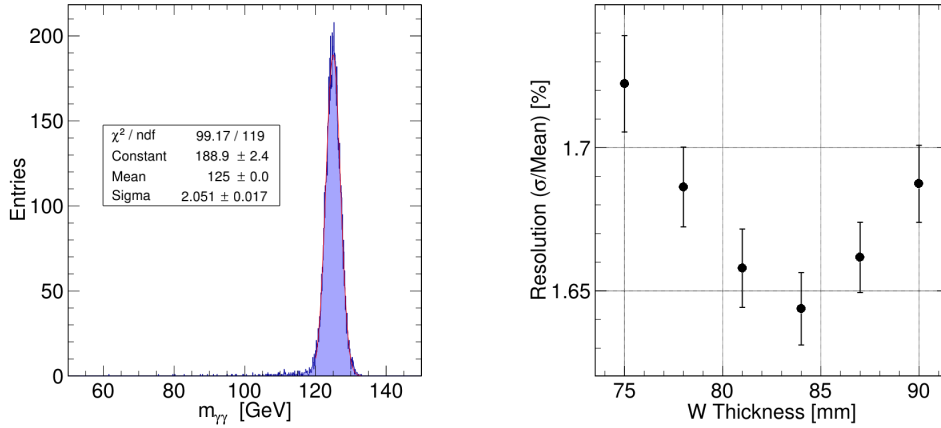

Figure 5.3: A typical distribution of Higgs boson mass reconstructed with the ECAL alone for $\nu\nu H(\rightarrow \gamma\gamma)$ events (left) and the resolution of the reconstructed Higgs boson mass for different total tungsten absorber thickness of the ECAL (right). The mass resolution is extracted from a Gaussian fit to the mass distribution. The best Higgs mass resolution is achieved when the total thickness of tungsten absorber of the ECAL is 84 mm.

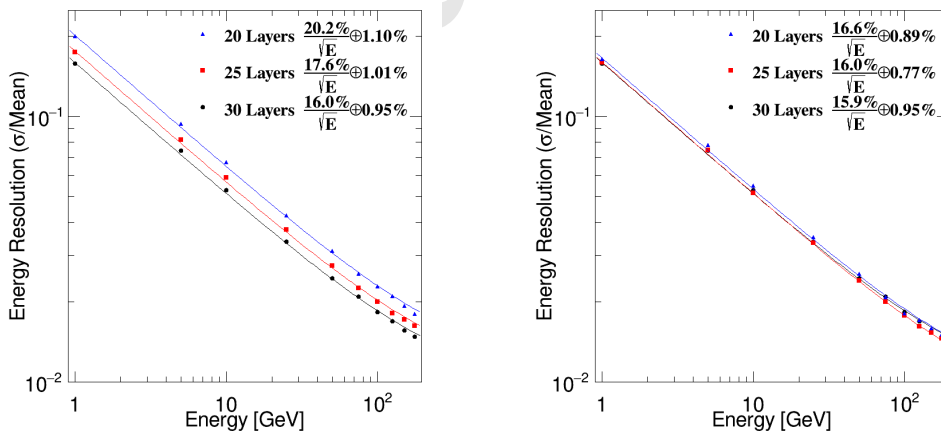

Figure 5.4: Photon energy resolution of the silicon-tungsten ECAL as a function of photon energy for different numbers of sampling layers of the ECAL(left) and together with different thickness of silicon sensors (right). Photons are incident at a certain spot of the endcap ECAL perpendicularly. The photon energy resolution degrades by 11% and 26% when the number of sampling layers is reduced from 30 to 25 and 20, respectively. The resolution degradation can be compensated by increasing the thickness of silicon sensors.

1 The Higgs boson mass resolution in the $\nu\nu H, H \rightarrow gg$ process was examined for the
 2 first aspect. Showers induced by the photons in the gluon jets need to be well separated
 3 from the rest of the jets in the ECAL for precise mass measurement of the two-jet system
 4 of $H \rightarrow gg$. The sensor size of the ECAL determines the shower separation power of the
 5 ECAL, and hence expects to have an impact on the Higgs boson mass resolution in this
 6 process. Table 5.1 gives the Higgs mass resolution in the process for different sensor sizes.
 7 There is no significant effect on the Higgs mass resolution in the $H \rightarrow gg$ decay mode
 8 when the sensor size changes from 5 mm to 10 mm, and there is only 5% degradation in
 9 the resolution when even increasing to 20 mm.

Silicon sensor size (mm)	Higgs boson mass resolution (with statistic error)
5	$3.74 \pm 0.02 \%$
10	$3.75 \pm 0.02 \%$
20	$3.93 \pm 0.02 \%$

Table 5.1: Higgs mass resolution for the $\nu\nu H, H \rightarrow gg$ events for different ECAL sensor sizes. No significant impact of the sensor size on the Higgs mass resolution is found in the $\nu\nu H, H \rightarrow gg$ process.

10 The impact of sensor size on identification of close-by photons was evaluated using
 11 events simulated for two parallel photons with different distance between the two photons.
 12 Figure 5.5 shows the reconstruction efficiency of the di-photon events as a function of the
 13 distance between the two photons for different sensor sizes. The di-photon events can
 14 be successfully reconstructed once the sensor size is smaller than half of the distance
 15 between the two photons. This demonstrates the strong correlation between sensor size
 16 and photon shower separation power. And a small ECAL sensor size has to be adopted
 17 if separating close-by photon showers is required. This is most relevant for τ physics
 18 studies using $Z \rightarrow \tau\tau$ events, where there are photons that are very close to each other or
 19 other particles in the τ decays. Table 5.2 presents the percentage of photons in τ decays
 20 that can't be well reconstructed due to overlapping with other showers in the ECAL for
 21 different sensor sizes. The percentage remains very low when the sensor size is within 10
 22 mm, but jumps to 20% once going beyond that.

23 Having taken into account the both aspects of Higgs mass resolution and identification
 24 of close-by photons, the optimised ECAL sensor size is 10 mm.

Cell size (mm)	Percentage of inseparable photons
1	0.07%
5	0.30%
10	1.70%
20	19.6%

Table 5.2: Percentage of photons in τ decays that can't be separated from neighboring particles in the ECAL for $Z \rightarrow \tau\tau$ events for different ECAL sensor sizes. Almost all photons in the τ decays can be well reconstructed for a ECAL sensor size up to 10 mm. A significant portion of the photons fail to be separated from other particles in the ECAL when the sensor size exceeds 10 mm.

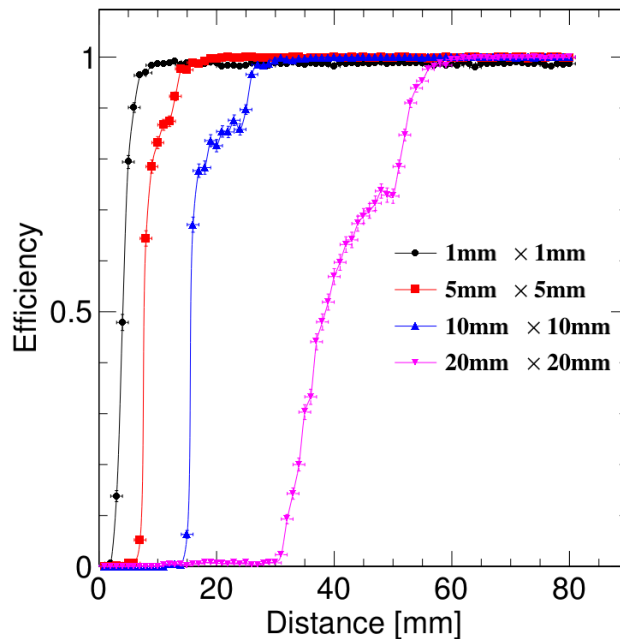

Figure 5.5: Reconstruction efficiency of events with two parallel 5-GeV photons as a function of the distance between the two photons for different ECAL sensor sizes. The reconstruction of the di-photon events is fully efficient once the sensor size is smaller than half of the distance between the two photons.

1 It should be noted that the above set of optimisation studies were performed for the
 2 Silicon-Tungsten ECAL option. The same set of studies were performed for the Scintillator-
 3 Tungsten ECAL option as well, and quite consistent results were obtained except the
 4 thickness of its sensors (scintillator strips) is much larger than the silicon sensors.

5 5.3.2 Silicon-Tungsten Sandwich Electromagnetic Calorimeter

6 5.3.2.1 Silicon sensors

7 Among several sensor techniques, silicon PIN diodes with high resistivity offer several
 8 unique intrinsic advantages as follows.

- 9 ▪ **Stability:** under a reasonable bias voltage, a completely depleted silicon PIN diode
 10 has unity gain, and a signal response to a Minimum Ionizing Particle (MIP) mostly
 11 defined by the sensor thickness, with a relatively low dependence on the operating
 12 environment including temperature, humidity, etc.
- 13 ▪ **Uniformity:** the control of the sensor thickness within large production batches (typ-
 14 ically to less than a percent) ensures uniform responses within a wafer and between
 15 different wafers. The non-sensitive area between wafers has recently been reduced by
 16 the use of laser cutting, thinned guard-ring design [3], and would benefit from the
 17 use of larger ingot size (8" becoming the standard).
- 18 ▪ **Flexibility:** the dimension and geometry of the cells can be flexibly defined. The
 19 readout pads on the PCB need to be compatible.
- 20 ▪ **High signal-to-noise (S/N) ratio:** for a MIP, the most probable number of electron-
 21 hole pairs generated in $1\mu\text{m}$ thick silicon is around 76 (while the average number is

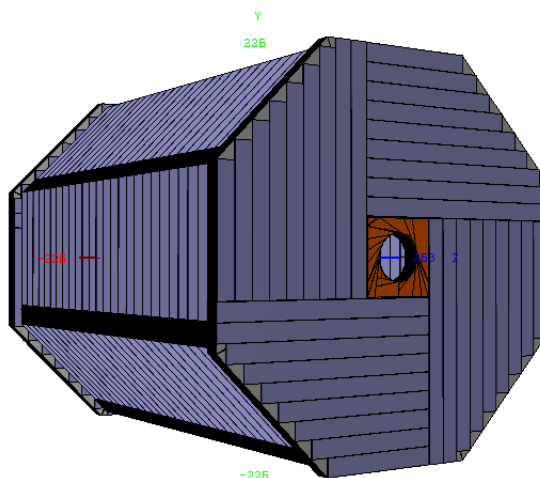

Figure 5.6: Schematic of the CEPC ECAL layout in its baseline design. The ECAL is organised into one cylindrical barrel and two disk-like end-cap sections, with 30 layers in each section. The barrel section is arranged into 8 staves, each consisting of 5 trapezoidal modules. Each of the two endcap sections is made of four quadrants, each consisting of 2 modules. The ECAL barrel overall radius is 2028mm in X-Y plane, the two end-caps are located at ± 2635 mm.

1 108), which yields an excellent S/N ratio of silicon sensors. Thus, MIP tracks can
 2 be easily tracked in the calorimeter, which is critical to the good performance of the
 3 ECAL.

4 One concern with the silicon sensors is the price, which could be very high.

5 By integrating the silicon sensors with tungsten plates and carbon fiber structures, the
 6 SiW-ECAL offers an excellent option for the PFA optimized calorimetry.

7 5.3.2.2 Geometry and mechanical design

8 A key requirement for the calorimeter system is to ensure the best possible hermeticity.
 9 Three regions need to be considered, including the boundaries of mechanical modules,
 10 the overlap region between the barrel and endcap sections, and very forward regions near
 11 forward detectors. A design with large ECAL modules is preferred to minimize crack
 12 regions in the barrel section, and the inter-module boundaries should not point back to
 13 the interaction point (IP). As shown in Figure 5.6, an octagonal shape is adopted to ap-
 14 proximate the cylindrical symmetry and the modules are designed in such a way that the
 15 cracks are at a large angle with respect to the radial direction. One eighth of the barrel
 16 ECAL is called a stave. Each stave is fastened to the HCAL front face with a precise sys-
 17 tem of rails. Some space is left between the ECAL and HCAL to accommodate services
 18 including cooling, power and signal cabling. Along the beam direction, a stave is divided
 19 into five modules. The two ECAL endcap sections are fastened to the front face of HCAL
 20 endcap sections using a similar rail system.

21 **Longitudinal arrangement** The ECAL is composed of 30 layers in the longitudinal
 22 direction. To improve performance on low energy photons (< 5 GeV), the 30 layers are
 23 split into 2 sections with different thickness of absorber layers. The first section contains
 24 20 layers of $0.6X_0$ (or 2.1 mm) thick tungsten plates corresponding to 12 radiation lengths.
 25 It is followed by the second section with 10 layers of $1.2X_0$ thick (4.2 mm) tungsten plates

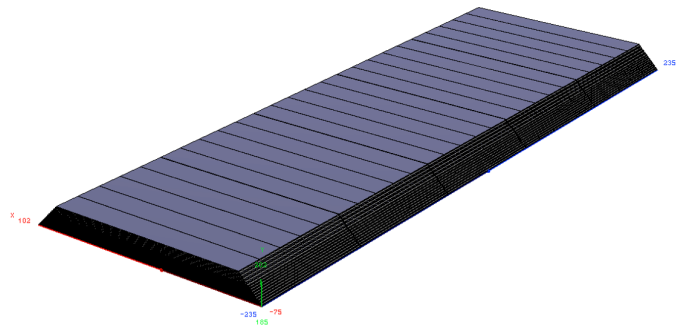

Figure 5.7: Schematic of the structure of one ECAL stave. Each stave is made up of 5 trapezoidal modules, and each module contains up to 5 columns.

1 corresponding to another 12 radiation lengths. The ECAL starts with an sensitive layer.
 2 Each sensitive layer is equipped with 0.5mm thick silicon sensors. The granularity of
 3 sensitive layers is determined by the silicon sensor size which is $10 \times 10 \text{mm}^2$ for all
 4 layers. The two longitudinal sections are both held on a 20 mm thick base plate made of
 5 carbon-fiber.

6 **Structures** The ECAL barrel section consists of 8 staves, each composed of 5 trape-
 7 zoidal modules as shown in Figure 5.7. A barrel module contains 5 columns. The num-
 8 bers of modules and columns are positioned along the beam line and chosen to be odd in
 9 number and symmetrically placed in order to avoid any pointing-like dead regions at the
 10 azimuthal plane perpendicular to the beam direction at the IP. The column size is 186 mm
 11 by mechanical limits and by cost optimization considerations, in order to contain exactly
 12 two 6-inch wafers or one and a half 8-inch wafers. Integrating the column size, walls of
 13 modules and contingencies, the barrel length adds up to 4700 mm in the beam direction.
 14 A gap of typically 100 mm is left between the barrel sides and end-cap front faces. The
 15 precise dimension will depend on the amount of services for the ECAL, the HCAL and
 16 the tracker system (including power and DAQ cabling, cooling pipes, patch panels, etc.).

17 The two end-cap sections are made up of 4 quadrants, each of which is then made up
 18 of 2 modules with one of the modules containing 4 columns and other other 3 columns.
 19 The endcap inner radius is fixed by the ECAL ring at 400 mm. With 7 columns, the
 20 end-cap outer radius is 2088 mm. An overshoot of 32 mm is kept between the outer
 21 radii of the barrel and of the end-caps, in order to contain the EM shower impinging the
 22 overlap region. This fixes the inner radius of the barrel section to 1843 mm. For the above
 23 structures, summing up all barrel and end-cap sections, 256 ECAL columns are needed.

24 **Active Sensor Unit** Each ECAL column is made up of several ECAL slabs. Each
 25 slab consists of two symmetric sensitive layers and one tungsten plate. Each sensitive
 26 layer contains a layer of silicon sensors glued on a PCB, equipped with readout ASICs,
 27 a high voltage distribution by a Kapton foil and copper layers for passive cooling. The
 28 components are attached on both sides of an H-shaped carbon fiber cradle, with a tungsten
 29 core, and shielded by an aluminum cover. To insure scalability and industrial production,
 30 the design has been made as modular as possible: each basic unit is an ASU (Active Sensor
 31 Unit), which currently has a $18 \times 18 \text{mm}^2$ PCB glued with 4 pieces of $90 \times 90 \text{mm}^2$
 32 silicon wafers. Each ASU will handle 256 silicon pads with 4 ASIC chips, for the cell
 33 size of $10 \times 10 \text{mm}^2$. The ASUs are chained together for the clock and configuration
 34 distributions and data collection.

5.3.2.3 SiW-ECAL electronics

One of the most critical elements of the CEPC calorimeters is the readout electronics which is defined by the dynamic range, the effective digitisation, mode of trigger, the rate of working and power consumption per channel.

Dynamic range: A MIP going through a $725\ \mu\text{m}$ silicon diode will produce around 60000 electron-pairs holes (or a charge of 9.6 fC) as the most probable value (MPV). To record MIPs with an efficiency higher than 95%, this determines the lower limit of the dynamic range to a 1/3 of the MPV. The higher limit is given by the number of MIP equivalents at the core of the high-energy EM showers, which can reach up to 10000 MIPs (or 96pC) within a $11 \times 11\ \text{mm}^2$ cell.

Timing: Time measurements of energy depositions in the calorimeters can be useful to Particle Flow algorithms to help disambiguate particle contributions. For the CEPC as a lepton collider, normally with a single primary vertex, precision timing of individual cells - or group of cells - could still be useful to reduce the confusion in the calorimeters and improve the energy resolution, which however needs further studies to quantitatively explore this potential. A SiW-ECAL ASIC with the most recent version (SKIROC2A) has been tested on a test board and reached a measure of timing resolution close to 1.1 ns for a signal amplitude corresponding to 5 MIPs [4].

Power consumption: The running conditions of a circular collider exclude pulsed operation as is planned for the linear colliders. As a point of reference, the current power consumption for the SKIROC2 chip is around 5 mW per channel in the continuous operating mode.

Occupancy: The occupancy of the calorimeters is expected to be very low. This offers room for an ultra-low power electronics design when there is no signal.

5.3.2.4 SiW-ECAL power consumption and cooling

To the first order, the amount of the power dissipation scales up with the number of electronics channels. One critical issue for the calorimeters is the cooling scheme. As for now there are two options. The CEPC ECAL is at the boundary of both options, with a limit for the purely passive option of the order of $20 \times 20\ \text{mm}^2$ cells for a increase of temperature limited to $\Delta T \sim 10\ ^\circ\text{C}$ at the far end of the slab.

- **Passive cooling:** this option requires a reduced number of channels in order to use only passive cooling at the rear of the detector. As an example, a $400\ \mu\text{m}$ thick copper sheet will drain the heat to the end of an ECAL slab, where it is then removed by an active cooling system installed near boundaries between barrel and endcap parts. A leak-less water cooling system can be such an option to extract the heat at the end of each slab from the copper. Details of implementation can be found in [5]. Full simulation studies based on PFA should be performed to provide the quantitative impact from a reduced granularity and the corresponding calorimeter performance.
- **Active cooling:** this option is the baseline high granularity design and requires the cooling system to provide cooling near the sensors and front-end electronics throughout the entire calorimeter system. A two-phase, low mass CO_2 cooling system is a promising option, which can be embedded in the absorber plates. There are already some simulation studies on a similar system adapted to the SiW-ECAL [6], where 3 mm thick copper plates, equipped with 1.6 mm inner diameter pipes for CO_2 circulation, with the ASICs glued on both sides of the slab. The study assumed a fully

transversally isolated system, with ASICs as the primary heat source at equilibrium dissipating 0.64 W (10 mW per channel times 64 channels), and a fixed working point of 20 °C for CO₂ (i.e. assuming perfect heat absorption). A doubled-sided module of 252 × 252 mm² holding 32 chips cooled by 2 × 2 pipes was simulated. Preliminary simulations in "ideal conditions" show a difference of $\Delta T \sim 2$ °C mostly centered on the ASICs (and only 0.3 °C in the heat exchanger).

5.3.2.5 SiW-ECAL R&D status

The performances of a SiW-ECAL have been explored using the "physical prototype" developed within the CALICE collaboration, with extensive beam tests during the years 2005- 2011 [7–9]. Some ASUs have been operated in beam test campaigns: first at CERN in 2015, where 3 ASUs were mounted on test boards which behaved as expected [10]; a signal to noise ratio (SNR) (defined as the Most Probable Value of a Landau fit on data, divided by the Gaussian width of the noise) reached typical values of 15-18, with a very limited number of masked channels.

In a recent a beam test at DESY with 1-5 GeV electrons, "short slabs" (featuring all the elements as required but limited to a single ASU on a single side) could reach a SNR of around 20 on average [11].

The collected data is still under analysis, but they are expected to be similar to the SiW-ECAL physical prototype. The construction of a "long slab" is being actively pursued, and should be completed toward the end of year 2019; the R&D involves all the power, cooling and front-end electronics issues. The results and design will have to be optimized for a circular collider, where the power-pulsing operation is not allowed.

5.3.3 Scintillator-Tungsten Sandwich Electromagnetic Calorimeter

5.3.3.1 Introduction

Alternatively, a sampling calorimeter with scintillator-tungsten structure is proposed. It can be built in a compact and cost effective way. The layout and structure of the scintillator-tungsten ECAL is very similar to that of the silicon-tungsten ECAL. Major design parameters for the scintillator-tungsten ECAL were also studied and optimized, with an outcome quite similar to that of the silicon-tungsten ECAL. The primary difference is in the thickness of the active layers, and another difference being in the sensor shape of the active layers. The active layers of the scintillator-tungsten ECAL consists of 2 mm thick and 5 × 45 mm² large scintillator strips. The scintillator strips in adjacent layers are perpendicular to each other to achieve a small effective transverse readout cell size. Each strip is covered by a reflector film to increase light collection efficiency and improve the uniformity of scintillation light yield w.r.t. incident position by a particle on the strip. Photons from each scintillator strip are read out by a very compact photo-sensor, SiPM, attached to the strip. The SiPM and highly integrated readout electronics make the dead area in the scintillator-tungsten ECAL almost negligible. Figure 5.8 shows the schematic structure of a scintillator-tungsten ECAL module in the above configuration. Although a SiPM is coupled to a scintillator strip by side in this schematic, it should be pointed out that various schemes for coupling the SiPM to the scintillator strip are considered for optimum performance.

Plastic scintillator is a robust material which has been used in many high energy physics experiments. Production of scintillator strips can be made at low cost by the extrusion

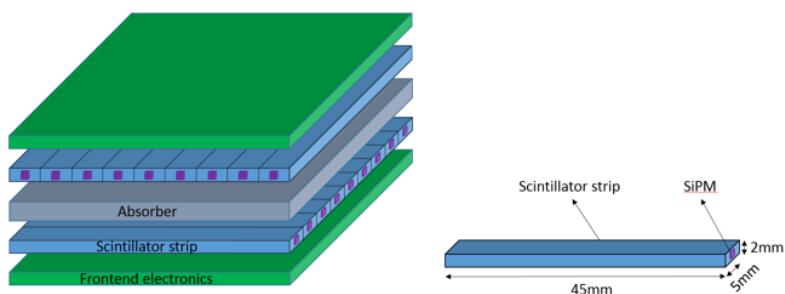

Figure 5.8: Layout of a scintillator-tungsten ECAL module and dimensions of a scintillator strip. The scintillator strips in adjacent layers are perpendicular to each other to achieve a small effective transverse readout cell size.

1 method. And prices for SiPMs on the market have also been falling constantly with the
 2 rapid development of the SiPM technology. Moreover, the number of readout channels
 3 can also be significantly reduced due to the strip readout configuration. So the total con-
 4 struction cost of the scintillator-tungsten ECAL is expected to be lower than that of the
 5 silicon-tungsten ECAL. Some key aspects of the scintillator-based ECAL technology were
 6 studied and optimized.

7 5.3.3.2 SiPM dynamic range

8 Because each pixel on a SiPM can only detect one photon at a time and a few nanosec-
 9 onds are needed before it is recovered, a SiPM is not a linear photon detection device,
 10 particularly when illuminated with high intensity light. Therefore, the dynamic range
 11 and linearity of SiPM needs to be addressed for its application in the scintillator-tungsten
 12 ECAL.

13 For a very short light pulse, the response of a SiPM can be formulated as

$$N_{fired} = N_{pixel}(1 - e^{-N_{pe}/N_{pixel}}) \quad (5.1)$$

14 Where N_{fired} is the number of fired pixels of a SiPM and N_{pixel} is the number of total
 15 pixels. However, light pulses produced in plastic scintillator last long enough for some
 16 pixels of a SiPM to detect more than one photon in one event of light generation. The
 17 response function of a SiPM is then modified in this case as

$$N_{fired} = N_{eff}(1 - e^{-N_{pe}/N_{eff}}) \quad (5.2)$$

18 Where N_{eff} stands for the effective number of pixels on a SiPM, which is a function
 19 of the width of incident light pulse. The response curve of a 10000-pixel ($10\mu\text{m}$ pitch
 20 size) and a 1600-pixel ($25\mu\text{m}$ pitch size) SiPMs with an active area of $1 \times 1 \text{ mm}^2$ were
 21 measured for light pulses with different widths, as shown in Figure 5.9. The dynamic
 22 range of the 10000-pixel SiPM is much larger than that of the 1600-pixel one, as expected,
 23 and can reach 4000 photon-electrons with very good linearity for short light pulses and
 24 much beyond if saturation correction is made. Also the linearity of response of SiPMs is
 25 improved with increasing of the width of incident light pulses. So care has to be taken if
 26 operation of SiPMs reaches saturated regions and correction is required. Rough estimation
 27 suggests a SiPM dynamic range of at least up to 10000 photon-electrons is needed for a
 28 scintillator-tungsten ECAL at the CEPC experiment for $H \rightarrow \gamma\gamma$ measurement. So large-
 29 area SiPMs with a large number of pixels are favored for use in the CEPC scintillator-

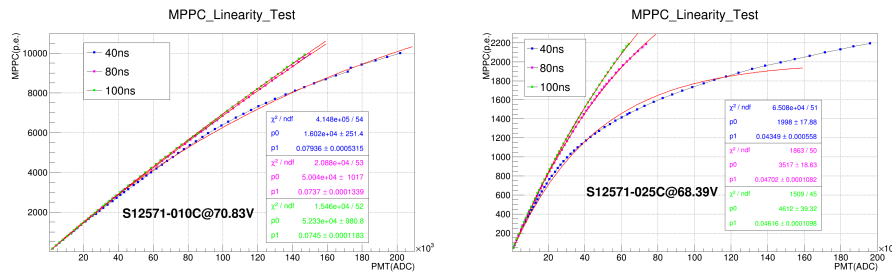

Figure 5.9: Response linearity (the number of photo-electrons detected with a SiPM as a function of the number of incident photons) of SiPMs with different numbers of pixels (left: 10000-pixel SiPM, right: 1600-pixel SiPM) for light pulses with different widths (blue: 40ns, red: 80ns and green: 100ns). The linearity of SiPM response with 10000 pixels is better than that with 1600 pixels. And the range for linear response of SiPM gets larger for a wider light pulse.

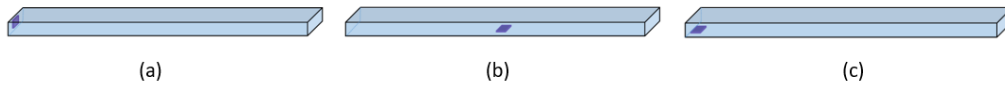

Figure 5.10: Three SiPM to scintillator strip coupling configurations explored for the design of scintillator-tungsten ECAL: (a) a SiPM is embedded in a scintillator strip on one side (side), (b) a SiPM is embedded in a scintillator strip at the center of the bottom face (bottom-center), (c) a SiPM is embedded in a scintillator strip at one end of the bottom face (bottom-end).

1 tungsten ECAL because of high dynamic ranges. This is also becoming increasingly
2 practical as the SiPM price per cm^2 has been dropping significantly.

3 5.3.3.3 Performance of scintillator sensitive unit

4 A scintillator sensitive unit is a scintillator strip coupled with a SiPM. When a SiPM is
5 coupled to a scintillator at one position, the light output is expected to depend on the
6 scintillation light propagation distance along the strip to the SiPM coupling point. This
7 dependance would introduce non-uniformity of light output, hence affecting the ECAL
8 performance. Three configurations of a SiPM coupling to a scintillator strip were ex-
9 plored as shown in Figure 5.10, to minimise the non-uniformity of light output. And
10 the uniformity of light output was measured with a Sr90 source for the three SiPM cou-
11 pling configurations, respectively, where the pitch size of the SiPM is $10\text{-}\mu\text{m}$. Figure 5.11
12 shows the measured uniformities. The side and bottom-end configurations give a similar
13 uniformity of 30%, while the bottom-center configuration presents a very good unifor-
14 mity of 10% without reduction of light output. Furthermore, such a configuration has
15 additional advantages of completely eliminating dead areas between scintillator strips due
16 to mounting of SiPMs and allowing to use SiPMs with very large areas which is essential
17 for meeting the requirement on dynamic range of SiPMs. For these attractive features, the
18 bottom-center SiPM coupling configuration is adopted for the scintillator-tungsten ECAL.

19 Light output of scintillator sensitive unit was also studied with the scintillator strip
20 wrapped with different reflectors as shown in Figure 5.12. ESR reflector gives much
21 higher light out than Tyvek reflector.

22 Light output of scintillator sensitive unit would depend on the pitch size of the SiPM due
23 to different photon detection efficiency. Figure 5.13 shows the ligh output of scintillator
24 sensitive units with SiPMs that have the same sensitive area ($1 \times 1 \text{ mm}^2$) but with different

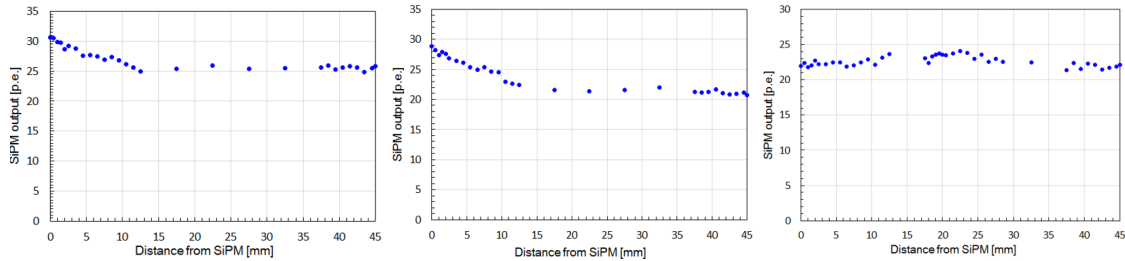

Figure 5.11: Light output of a scintillator sensitive unit with three SiPM coupling configurations: side (left), bottom-end (middle), bottom-center (right). The bottom-center configuration gives the best uniformity of 10% without reduction of light output.

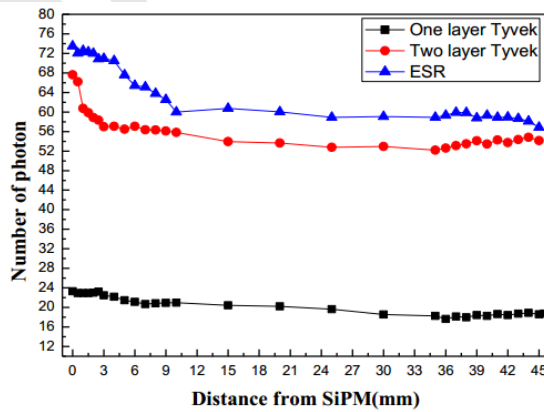

Figure 5.12: Light yields of scintillator strips with different reflectors versus the distance of an incident particle from SiPM . The scintillator with ESR gives the highest light yield.

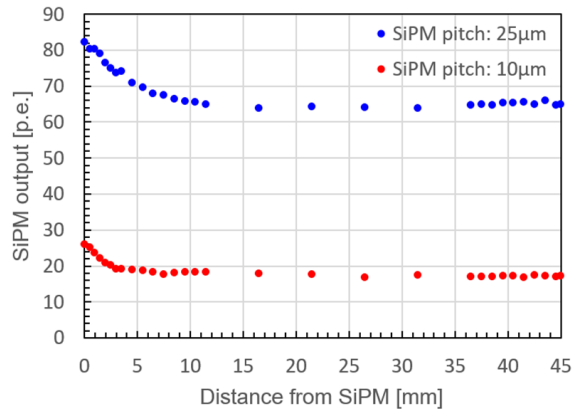

Figure 5.13: Light yields of scintillator strips coupled with SiPMs with different pitch sizes (red: $10\mu\text{m}$, blue: $25\mu\text{m}$). The SiPM with the larger pitch size of $25\mu\text{m}$ has a significant higher light yield (about 65 p.e.) than that with the smaller pitch size of $10\mu\text{m}$ (about 18 p.e.) due to a higher photon detection efficiency.

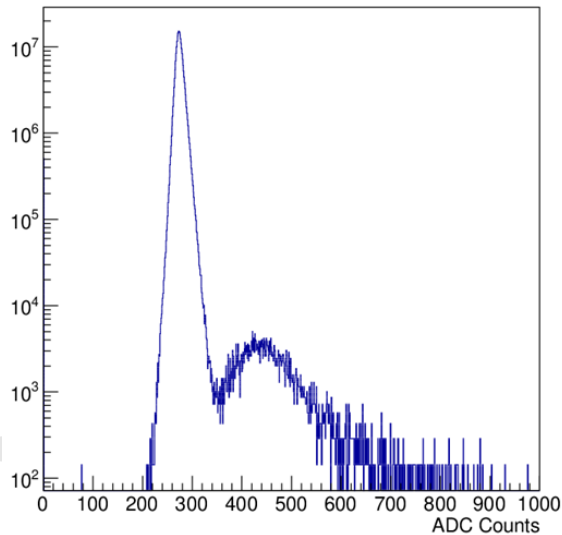

Figure 5.14: The pulse height distribution for cosmic-ray signals of the scintillator sensitive unit with a $10\mu\text{m}$ SiPM. Cosmic-ray signals can be found well separated from noise demonstrating the sensitivity of the scintillator sensitive unit to M.I.Ps.

1 pitch sizes ($25\mu\text{m}$ vs. $10\mu\text{m}$). The light output with the $10\mu\text{m}$ SiPM is only about 1/3 of
 2 that with the $25\mu\text{m}$ SiPM due to its much lower photodetection efficiency. So light output
 3 should be taken into account when choosing small-pitch SiPMs for a high dynamic range.
 4 It has to be ensured the scintillator sensitive unit is sensitive to M.I.Ps. Figure 5.14 shows
 5 the pulse height distribution for cosmic-ray signals of the scintillator sensitive unit with
 6 a $10\mu\text{m}$ SiPM using the readout electronics described in 5.3.3.4. Cosmic-ray signals are
 7 seen well separated from noise demonstrating the sensitivity to M.I.Ps.

8 5.3.3.4 SiPM readout electronics

9 The readout electronics of the ECAL has to provide high dynamic range for energy mea-
 10 surements. A 100 GeV photon shower may leave an energy deposit of $1\sim 800$ MIP-
 11 equivalent in a single cell. A high spatial granularity of the ECAL readout, typically

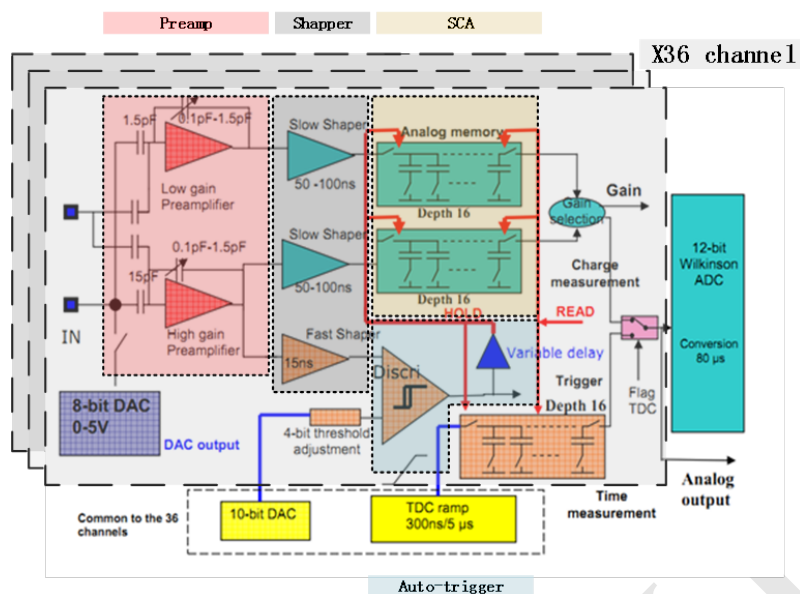

Figure 5.15: Schematic of the SPIROC2b ASIC chip. It consists of a readout chain with an amplifier-shaper using a RCnCRp filter, then the discriminator sends trigger to a Switched-Capacitor-Array (SCA). A 12-bit Wilkinson ADC is used for digitizing the analog voltage in the SCA.

1 10 mm, is required for the Particle Flow Algorithm (PFA). This, in turn, results in a large
 2 total channel count and a high density of channels. For this reason, multi-channel readout
 3 chips are considered.

4 The full readout chain of the electronics consists of two parts: Front-End and Back-
 5 End. The Front-End electronics (FE) is embedded into the layers of ECAL. It performs
 6 amplification, auto-triggering, digitization and zero-suppression, with local storage of data
 7 between the working phases. The Back-End electronics (BE) collects data and configures
 8 the readout chips before system running.

9 Several studies and existing calorimeter readout electronics have shown that one can
 10 obtain optimized energy resolutions using a preamplifier-shaper and digitizing the pulse
 11 at the peak amplitude. For instance, a preamp-shaper-SCA structure of analog circuit
 12 was applied on an ILC HCAL and implemented in an ASIC names SPIROC2b. A similar
 13 approach can be applied for the CEPC-ECAL. The analog part of the SPIROC2b is
 14 schematically depicted in Figure 5.15. This ASIC is presently under consideration for the
 15 CEPC-ECAL.

16 The basic principle consists of a readout chain with an amplifier-shaper using a RCn-
 17 CRp filter delivering a pulse length of about 50-200ns duration for a SiPM pulse signal.
 18 This signal is also shaped by a fast shaper in parallel to generate fast and narrow pulse for
 19 pulse discrimination. Then, the discriminator sends the trigger to a Switched-Capacitor-
 20 Array (SCA) for locking the peak value of the slowly shaped signal. The locked voltage
 21 value corresponds to the charge that the circuit received. A 12bit Wilkinson ADC is
 22 used for digitizing the analog voltage in the SCA. Future detailed implementations of the
 23 calorimeter front-end electronics for CEPC is still considered using the ROC series ASIC
 24 but newer versions.

25 The maximum data rate to the Back-End electronics can be estimated as follows. As-
 26 suming continuous operation, the SPIROC2b will be switched between three states called
 27 Acquisition, AD Converting and Readout. Only in the Acquisition state can SPIROC2b

1 receive signal from the SiPM and store in received charge in the SCA at a rate of about
 2 5MHz. The two other states contribute to the “dead-time” status. There is depth of 16
 3 in the SCA corresponding to $4\mu\text{s}$ for Acquisition, and an additional $\sim 4\text{ ms}$ for ADC and
 4 Readout. Therefore, the maximum data rate is 16 events per 4ms which corresponds to
 5 4 kHz. Each data package is 2 Kbytes in size.

6 The number of chips readout in series in a single layer will multiply the duration of
 7 Readout. Assuming that there are 4 chips in one layer, there is 16ms for Readout. The
 8 maximum events rate is reduced to 1 kHz and leads to about a transmission of 5 Mbyte/s.
 9 This can easily be managed with 100Mbps links.

10 The power consumption in the front-end will be dominated by the ASIC and more
 11 specifically by the analog part of the ASIC. One SPIROC2b consumes 250.8mW of which
 12 about 150mW is consumed by the analog part. In actual use, most of the cycle is in ADC
 13 and Readout. This leads to about 150mW power consumption per chip and 4mW per
 14 channel.

15 The electronic calibration and cosmic ray tests have been done. From these electronic
 16 calibrations we have obtained that the noise of readout system is 46 fC in RMS. The least-
 17 significant bit of the ADC in high gain and low gain is 151/pC and 10.3/pC, respectively,
 18 while the maximum ADC range is 4096. A dynamic range of 100fC-300pC of the read-
 19 out system is measured with this method. Cosmic ray results show that the system can
 20 distinguish a MIPs signal from pedestal well with a measured charge of approximately
 21 1 pC.

22 5.4 Hadronic Calorimeter for Particle Flow Approach

23 5.4.1 Introduction

24 High-granularity hadronic calorimetry is an essential concept in PFA-based experiments
 25 such as those proposed for CEPC. The high spatial granularity provides a means to sep-
 26 arate the deposits of charged and neutral hadrons and to precisely measure the energy
 27 of the neutrals. The contribution of the neutrals to the jet energy, around 10% on aver-
 28 age, fluctuates in a wide range from event-to-event, and the accuracy of the measurement
 29 is the dominant contribution to the particle flow resolution for jet energies up to about
 30 100 GeV. For higher energies, the performance is dominated by a term in the PFA resolu-
 31 tion called the confusion term. This term originates from failures in both the topological
 32 pattern recognition and energy information that are important for correct track cluster as-
 33 signment. A high-granularity hadronic calorimeter is thus needed to achieve excellent jet
 34 energy resolution.

35 The HCAL systems considered here are sampling calorimeters with steel as the ab-
 36 sorber and scintillator tiles or gaseous devices with embedded electronics for the active
 37 part. The steel was chosen due to its rigidity which allows to build self-supporting struc-
 38 tures without auxiliary supports (dead regions). Moreover, the moderate ratio of hadronic
 39 interaction length ($\lambda_I = 17\text{ cm}$) to electromagnetic radiation length ($X_0 = 1.8\text{ cm}$) of
 40 iron, allows a fine longitudinal sampling in terms of X_0 with a reasonable number of lay-
 41 ers in λ_I , thus keeping the detector volume and readout channel count small. This fine
 42 sampling is beneficial both for the measurement of the sizable electromagnetic energy part
 43 in hadronic showers and for the topological resolution of shower substructure, needed for
 44 particle separation.

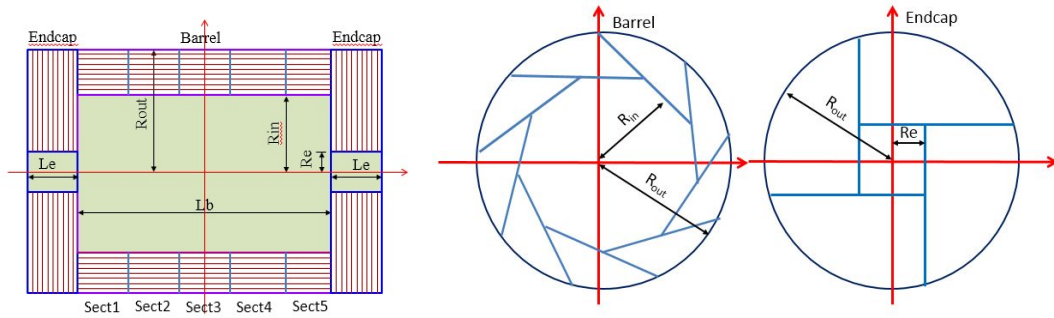

Figure 5.16: HCAL layout in Y-Z plane (left plot), HCAL Barrel layout in X-Y plane (middle plot) and HCAL Endcap layout in X-Y plane (right plot). The inner radius in X-Y plane is 2300mm, the outer radius is 3340mm. The inner and outer of HCAL endcap in Z-axis are 2670mm and 3710mm, respectively.

1 The active detector element has finely segmented readout pads, with $1 - 3 \times 1 - 3 \text{ cm}^2$
 2 size, for the entire HCAL volume. Each readout pad is readout individually, so the readout
 3 channel density is approximately $4 \times 10^{4-5}/\text{m}^3$. For the entire HCAL, with $\sim 100 \text{ m}^3$
 4 total volume, the total number of channels will be $4 \times 10^{6-7}$ which is one of the biggest
 5 challenges for the HCAL system. On the other hand, simulation suggests that, for a
 6 calorimeter with cell sizes as small as $1 \times 1 \text{ cm}^2$, a simple hit counting is already a good
 7 energy measurement for hadrons. As a result, the readout of each channel can be greatly
 8 simplified and just record 'hit' or 'no hit' according to a single threshold (equivalent to
 9 a '1-bit' ADC). A hadron calorimeter with such kind of simplified readout is called a
 10 Digital Hadron Calorimeter (DHCAL). In a DHCAL, each readout channel is used to
 11 register a 'hit', instead of measure energy deposition, as in traditional HCAL systems.
 12 In this context, gas detectors (such as RPC, GEM) become excellent candidates for the
 13 active element of a DHCAL. Another technology option is the Analog Hadron Calorimeter
 14 (AHCAL) which is based on scintillator coupled with SiPMs as the active sensor.

15 A drawing of the HCAL structure is shown in Figure 5.16, the barrel part is made of 5
 16 independent and self-supporting wheels along the beam axis. The segmentation of each
 17 wheel in 8 identical modules is directly linked with the segmentation of the ECAL barrel.
 18 A module is made of 40 stainless steel absorber plates with independent readout cassettes
 19 inserted between the plates. The absorber plates consist of a total of 20 mm stainless steel:
 20 10 mm absorber from the welded structure and 10 mm from the mechanical support of the
 21 detector layer. Each wheel is independently supported by two rails on the inner wall of
 22 the cryostat of the magnet coil. The cables as well the cooling pipes will be routed outside
 23 the HCAL in the space left between the outer side of the barrel HCAL and the inner side
 24 of the cryostat.

25 5.4.2 Semi-Digital Hadronic Calorimeter (SDHCAL)

26 5.4.2.1 Introduction

27 For the CEPC, a SDHCAL based on gaseous detector is proposed. This is motivated by the
 28 excellent efficiency and very good homogeneity the gaseous detectors could provide. An-
 29 other important advantage of gaseous detectors is the possibility to have very fine lateral
 30 segmentation. Indeed, in contrast to scintillator tiles, the lateral segmentation of gaseous
 31 devices is determined by the readout electronics and not by the detector itself. Active

layer thickness is also of importance for what concerns the CEPC hadronic calorimeter to be placed inside the magnetic field. Highly efficient gaseous detectors can indeed be built with a thickness of less than 3 mm. While other detectors could achieve such performance, gaseous detectors have the advantage of being cost-effective and discharge free. They are also known for their fast timing performance which could be used to perform 4D construction of the hadronic showers. Such a construction can improve on hadronic shower separation by better associating the energy deposits belonging to the same shower from those of other showers. It can also improve on the energy reconstruction by identifying the delayed neutrons and assigning them a different weight.

To obtain excellent resolution in the hadronic shower energy measurement a binary readout of the gaseous detector is the simplest and most effective scenario. However, a lateral segmentation of a few millimeters is needed to ensure good linearity and resolution of the reconstructed energy. Such a lateral segmentation leads to a huge number of electronic channels resulting in a complicated readout system design and excessive power consumption. A cell size of $1 \times 1 \text{ cm}^2$ are found to be a good compromise that still provides a very good resolution at moderate energies. However, simulation studies show that saturation effects are expected to show up at higher energies ($> 40 \text{ GeV}$). This happens when many particles cross one cell in the center of the hadronic shower. To reduce these effects, multi-threshold electronics (Semi-Digital) readout is chosen to improve on the energy resolution by exploiting the particle density in a more appropriate way. These elements were behind the development of a Semi-Digital Hadronic CALorimeter (SDHCAL) that we propose to equip one of the CEPC future experiments.

Even with a $1 \times 1 \text{ cm}^2$ lateral granularity of the readout system, a large number of electronic channels is still needed. This has two important consequences. The first is the power consumption and the resulting increase of temperature which affects the behavior of the active layers. The other consequence is the number of service cables needed to power and readout these channels. These two aspects can deteriorate the performance of the HCAL and destroy the principle of PFA if they are not addressed properly.

The R&D pursued by the CALICE SDHCAL groups has succeeded to pass almost all the technical hurdles of the PFA-based HCAL. The SDHCAL groups have succeeded to build the first technological prototype [12] of these new-generation calorimeters with 48 active layers of GRPC, 1 m^2 each. The prototype validates the concept of the high-granularity gaseous detector and permits to study the energy resolution of hadrons one can obtain with such calorimeter. Figure 5.17 shows the energy resolution of SDHCAL with different numbers of layers using simulated pion samples. It indicates that SDHCAL with 40 layers yield decent performance with pion energies up to 80 GeV which is suitable for a CEPC detector.

A baseline detector of SDHCAL has been designed with 40 layers in total. Each layer contains 20 mm thick stainless steel, 3 mm thick GRPC and 3 mm for readout electronics with $1 \times 1 \text{ cm}^2$ readout pads on PCB board.

In order to investigate appropriate options for the active detector of the SDHCAL, two parallel detector schemes, the Glass Resistive Plate Chamber (GRPC) and the Thick Gaseous Electron Multiplier (THGEM) are proposed for the active layers of the SDHCAL.

5.4.2.2 GRPC based SDHCAL

The GRPC scheme The structure of GRPC proposed as an active layer of the HCAL for CEPC is shown in Figure 5.18. It is made out of two glass plates of 0.7 mm and 1.1 mm

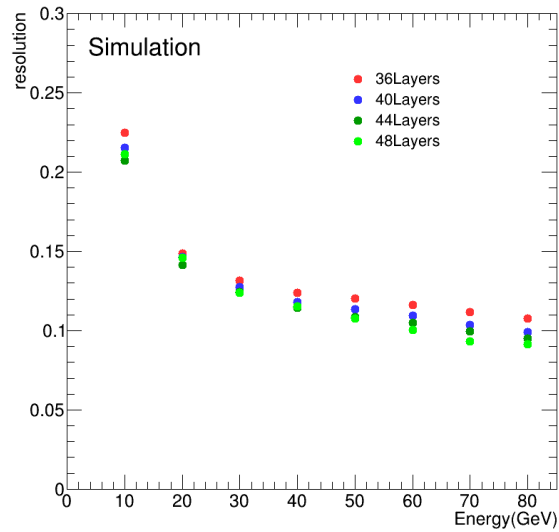

Figure 5.17: The energy resolution of SDHCAL with different number of layers versus simulated pion energy ranging from 10 GeV to 80 GeV. Energy resolution of SDHCAL with 48-layer, 44-layer, 40-layer, 36-layer are shown in light green, green, blue and red dots, respectively. It indicates that SDHCAL with 40-layer yields decent energy resolution, about 15% and 10% with pion energy of 20 GeV and 80 GeV, respectively.

1 thickness. The thinner plate is used to form the anode while the the thicker one forms
 2 the cathode. Ceramic balls of 1.2 mm diameter are used as spacers between the glass
 3 plates. The balls are glued on only one of the glass plates. In addition to those balls, 13
 4 cylindrical fiber-glass buttons of 4 mm diameter are also used. Contrary to the ceramic
 5 balls the buttons are glued to both plates ensuring thus a robust structure. Special spacers
 6 (ceramic balls) were used to maintain uniform gas gap of 1.2 mm. Their number and
 7 distribution were optimized to reduce the noise and dead zones (0.1%).

8 The distance between the spacers (10 cm) was fixed so that the deviation of the gap
 9 distance between the two plates under the glass weight and the electric force does not
 10 exceed 45 microns. The choice of these spacers rather than fishing lines was intended
 11 to reduce the dead zones (0.1%). It was also aimed at reducing the noise contribution
 12 observed along the fishing lines in standard GRPC chambers. The gas volume is closed
 13 by a 1.2 mm thick and 3 mm wide glass-fiber frame glued on both glass plates. The glue
 14 used for both the frame and the spacers was chosen for its chemical passivity and long
 15 term performance. The resistive coating on the glass plates which is used to apply the
 16 high voltage and thus to create the electric field in the gas volume was found to play im-
 17 portant role in the pad multiplicity associated to a MIP [13]. A product based on colloids
 18 containing graphite was developed. It is applied on the outer faces of the two electrodes
 19 using the silk screen print method, which ensures very uniform surface quality. The mea-
 20 sured surface resistivity at various points over a 1m² glass coated with the previous paint
 21 showed a mean value of 1.2 MΩ/cm² and a ratio of the maximum to minimum values of
 22 less than 2 ensuring a good homogeneity of the detector.

23 Another important aspect of this development concerns the gas circulation within the
 24 GRPC taking into account that for the CEPC SDHCAL, gas outlets should all be on one
 25 side. A realization of this system was developed. It is based on channeling the gas along
 26 one side of the chamber and releasing it into the main gas volume at regular intervals.

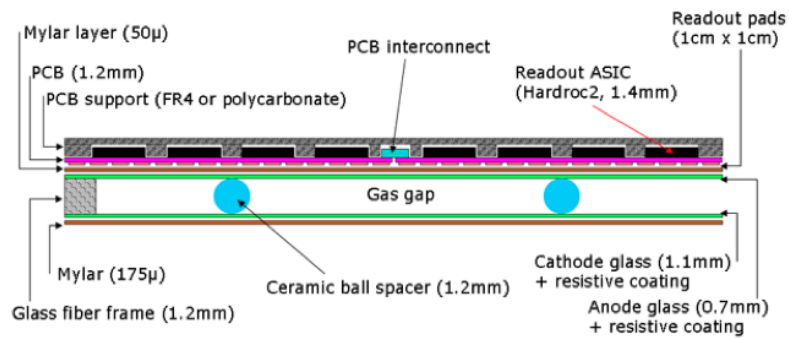

Figure 5.18: Cross-sectional view of an active layer with GRPC and readout layer. The GRPC gas gap is 1.2mm, with two glass plates of 1.1mm (cathode plate) and 0.7mm (anode plate) thickness. The thickness of PCB is 1.2mm and that of readout ASIC is 1.4mm.

1 A similar system is used to collect the gas on the opposite side. A finite element model
 2 has been established to check the gas distribution. The simulation confirms that the gas
 3 speed is reasonably uniform over most of the chamber area. The GRPC and its associated
 4 electronics are housed in a special cassette which protects the chamber and ensures that
 5 the readout board is in close contact with the anode glass. The cassette is a thin box
 6 consisting of 2.5 mm thick stainless steel plates separated by 6 mm wide stainless steel
 7 spacers. Its plates are also a part of the absorber.

8 The electronics board is assembled with a polycarbonate spacer which is also used to
 9 fill the gaps between the readout chips and to improve the overall rigidity of the detector.
 10 The electronics board is fixed on the small plate of the cassette with tiny screws. The
 11 assembled set is fixed on the other plate which hosts the detector and the spacers. The
 12 total thickness of the cassette is 11 mm with 6 mm of which due to the sensitive medium
 13 including the GRPC detector and the readout electronics.

14 **GRPC technological prototype** An SDHCAL prototype fulfilling the efficiency, robust-
 15 ness and the compactness requirements of the future PFA-based leptonic collider experi-
 16 ments [12] was built. A total of 48 cassettes as the one described above were built. They
 17 fulfilled a stringent quality control. It is worth mentioning that 10500 HR ASICs were
 18 produced and tested using a dedicated robot for this purpose. The yield was found to be
 19 higher than 92%. The ASICs were then fixed on the PCBs over a surface area of 1m^2
 20 and then subsequently fixed on the cassette cover once successfully tested. The cassettes
 21 were inserted in a self-supporting mechanical structure that was conceived and built in
 22 collaboration with the Spanish group of CIEMAT. The structure is made of Stainless Steel
 23 plates of 1.5 cm each. The plates were machined to have an excellent flatness and well
 24 controlled thickness. The flatness of the plates was measured using a laser-based inter-
 25 ferometer system. It was found that the flatness of the plates are less than 500 microns.
 26 In April 2012 the prototype was exposed to pion, muon, electron beams of both the PS
 27 and the SPS of CERN as shown in Figure 5.19. The data were collected continuously in a
 28 triggerless mode. Figure 5.20 shows the efficiency (left) and pad multiplicity (right) of the
 29 prototype GRPC chambers measured using the muon beam. Figure 5.21 shows a display
 30 of two events collected in the SDHCAL. One is a produced by a pion interaction (left) and
 31 the other by an electron interaction (right).

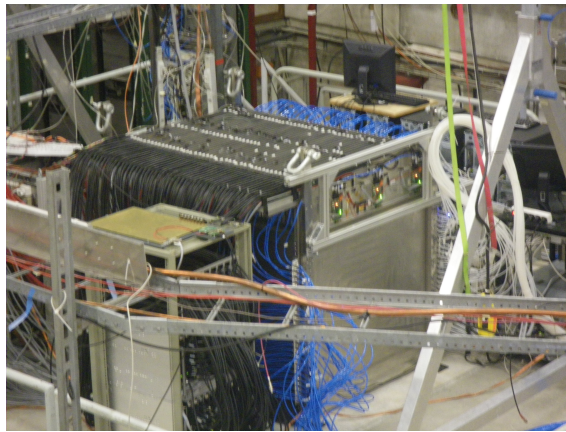

Figure 5.19: The SDHCAL prototype in beam test at CERN.

1 The SDHCAL prototype results obtained with a minimum data treatment (no gain cor-
 2 rection) show clearly that excellent linearity and good resolution [14] could be achieved
 3 on large energy scale as can be shown in Figure 5.22 where results obtained in two differ-
 4 ent beam lines are obtained using the same detector configurations. As is clearly demon-
 5 strated from this data, the high granularity of the SDHCAL allows one to study thoroughly
 6 the hadronic showers topology and to improve on the energy resolution by, among others,
 7 separating the electromagnetic and the hadronic contribution. The separation between
 8 close-by showers will also benefit from the high granularity on the one hand and the
 9 very clean detector response ($< 1 \text{ Hz/cm}^2$) on the other. The results obtained with the
 10 SDHCAL [15] confirm the excellent efficiency of such separation due to the SDHCAL
 11 performance.

12 The quality of data obtained during several campaigns of data taking at the CERN
 13 PS and SPS beam lines validates completely the SDHCAL concept. This is especially
 14 encouraging since no gain correction was applied to the electronics channels to equalize
 15 their response. Still, improvement was further achieved by applying gain and threshold
 16 correction schemes in terms of the calorimeter response homogeneity.

17 A digitizer describing the response of the GRPC within the SDHCAL was devel-
 18 oped [16]. It allows to study the SDHCAL behavior in a realistic manner in the future
 19 experiments.

20 In parallel to the prototype construction, a single cassette was tested in a magnetic field
 21 of 3 Tesla (H2 line at CERN) applying the power-pulsed mode. The test beam results [17]
 22 indicated clearly that the use of the power-pulsed mode in such a magnetic field is possible.
 23 The behavior of the detector in terms of efficiency, multiplicity, and other factors was
 24 found to be similar to those obtained in the absence of both the magnetic field and the
 25 power-pulsed mode.

26 **Current SDHCAL R&D** Large GRPC of 1m^2 were developed and built for the technologi-
 27 cal prototype. However, larger GRPC are needed in the SDHCAL proposed for future
 28 leptonic collider experiments. These large chambers with gas inlet and outlet on one side
 29 need a dedicated study to guarantee a uniform gas gap everywhere notwithstanding the
 30 angle of the plate. It is necessary also to ensure an efficient gas distribution as it was done
 31 for the 1m^2 chambers. To obtain this different gas distribution systems were studied. A
 32 new scheme with two gas inlets and one outlet was found to ensure an excellent homo-

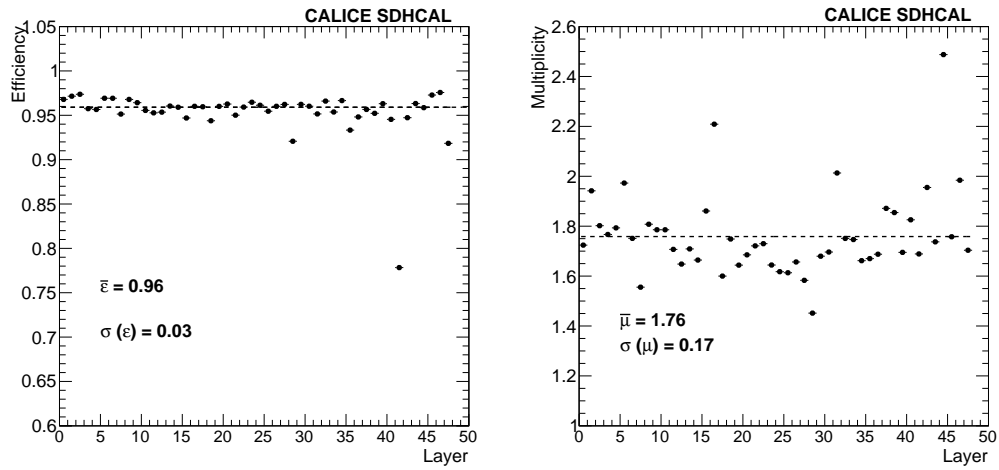

Figure 5.20: Left: Efficiency of the GRPC detectors of the SDHCAL, the average efficiency is 0.96 ± 0.03 . Right: The pad multiplicity of the GRPCs, it is 1.76 ± 0.17 . (Note: Figures taken from [14].)

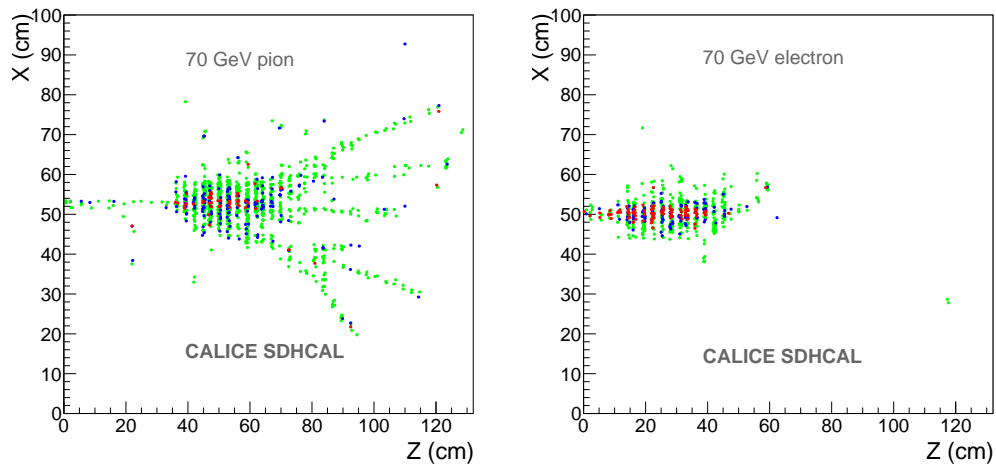

Figure 5.21: Left: Event display of an 70 GeV pion interaction in the SDHCAL prototype. Right: Event display of a 70 GeV electron interaction in the SDHCAL prototype. (Note: Figures taken from [14].)

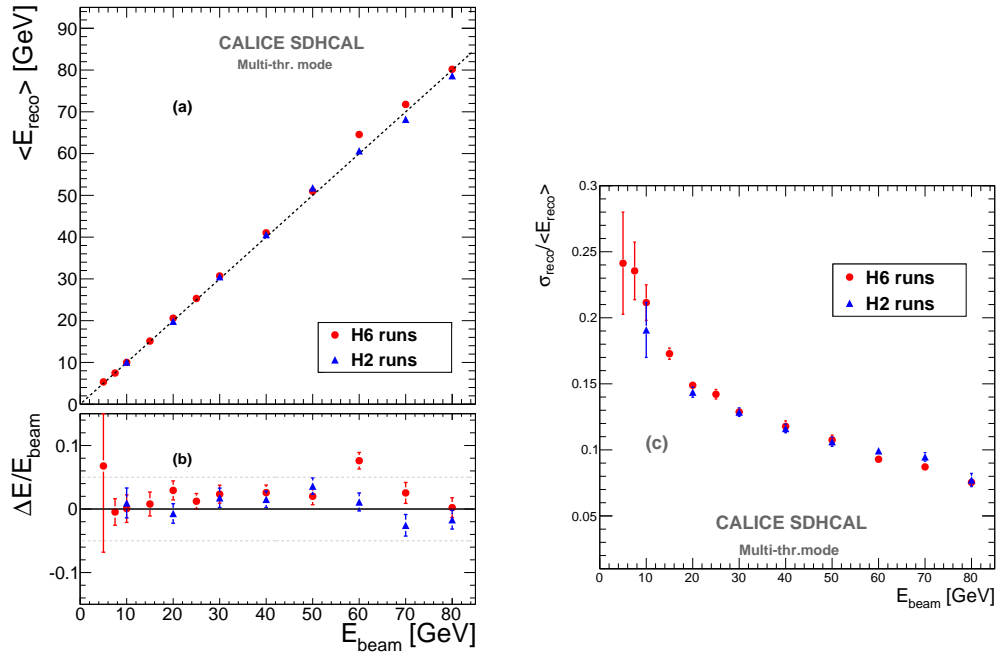

Figure 5.22: Left: a) Reconstructed energy of the hadronic showers collected in both H2 and H6 SPS beamlines. b) The relative deviation of the reconstructed energy with respect to the beam energy. Right: Relative energy resolution of the reconstructed hadronic shower. The pion beam of H6 beamline is largely contaminated by protons at high energy (>50 GeV). (Note: Figures taken from [14].)

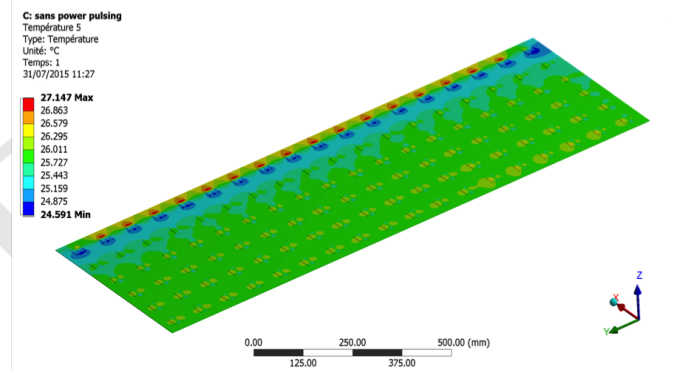

Figure 5.23: Temperature distribution in an active layer of the SDHCAL operated at continuous mode. The cooling system is based on circulating water inside copper tubes in contact with the ASICs.

- 1 geneity of the gas distribution. This system will be used in the near future to build large
- 2 detectors exceeding 2m².
- 3 To cope with the heating produced by the embedded readout system in case of limited
- 4 or even the absence of use of the Power Pulsing system, a new active cooling system is
- 5 being studied. Figure 5.23 shows a study of a water-based cooling system to absorb the
- 6 excess of heat in the SDHCAL. The cooling system is very simple but very effective as
- 7 well. It allows to keep the average temperature as well as the temperature dispersion of
- 8 the GRPC well under control.

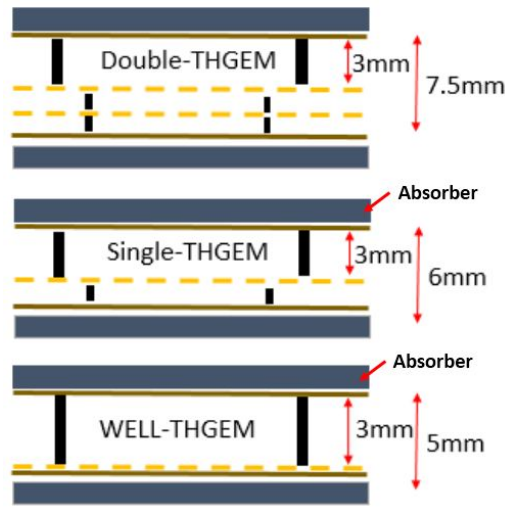

Figure 5.24: Schematic of three different types of THGEMs, eg. doubly-THGEM with thickness of 7.5mm (top plot), single-THGEM with thickness of 6mm (middle plot) and well-THGEM with thickness of 5mm (bottom plot).

1 5.4.2.3 THGEM-based DHCAL

2 **The THGEM scheme** The THGEM can be built in large quantities at low cost, which
 3 might make them suitable for the large CEPC HCAL. THGEM detectors can provide
 4 flexible configurations, which allow small anode pads for high granularity. They are ro-
 5 bust and fast, with only a few nano-seconds rise time, and have a short recovery time
 6 which allows a higher rate capability compared to other detectors. They are operated at a
 7 relatively low voltage across the amplification layer with stable high gain. The ionisation
 8 signal from charged tracks passing through the drift section of the active layer is amplified
 9 using a single layer or WELL-type THGEM structure. The amplified charge is collected
 10 at the anode layer with pads at zero volts. As the HCAL is located within the coil, WELL-
 11 THGEM, a single layer structure with thinner thickness, as shown in Figure 5.24, can be
 12 considered as the sensitive medium, to keep the HCAL compact.

13 Digital readout has been proposed to limit the total amount of data, which simplifies
 14 the data treatment without comprising the energy resolution performance. The readout
 15 electronics of the DHCAL will be integrated into the sensitive layer of the system, thus
 16 minimizing dead areas. Large electronics boards are assembled together to form extra
 17 large boards before being attached to the THGEM. The board assembly will utilise a
 18 mechanical structure made of 4 mm stainless steel plates. In addition, to keep the HCAL
 19 as compact as possible, the fully equipped electronic boards are designed to be less than
 20 2 mm thick in total.

21 A THGEM based detector for DHCAL has been designed with 40 layers in total. Each
 22 layer contains 2.0 cm thick stainless steel, 0.8 cm thick THGEM and readout electronics
 23 with $1 \times 1 \text{ cm}^2$ readout pads. As THGEM production technology matures, the maximum
 24 area of THGEM is limited only by the size of the CNC drilling area. The low cost of ma-
 25 terials and fabrication, robustness against occasional discharges, high gain and count rate
 26 capability of up to 10MHz/cm^2 make THGEM very attractive for building the DHCAL.
 27 As illustrated in Figure 5.24, the total thickness of the sensitive medium is 5 mm, which
 28 consists of 3 mm drift gap, 1 mm transfer gap and 1 mm induction gap. The absorber

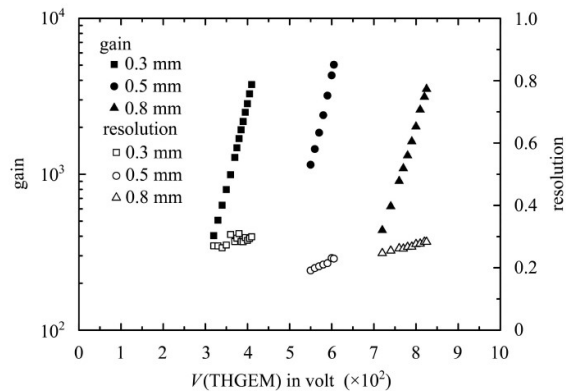

Figure 5.25: Gain and energy resolution of THGEM detector obtained with ^{55}Fe source. Black boxes (0.3mm thick), dots (0.5mm thick) and triangles (0.8mm thick) represent THGEM gain versus voltage, gain is achieved up to 8000. Hollow boxes, dots and triangles show energy resolution, typically around 20% to 25%.

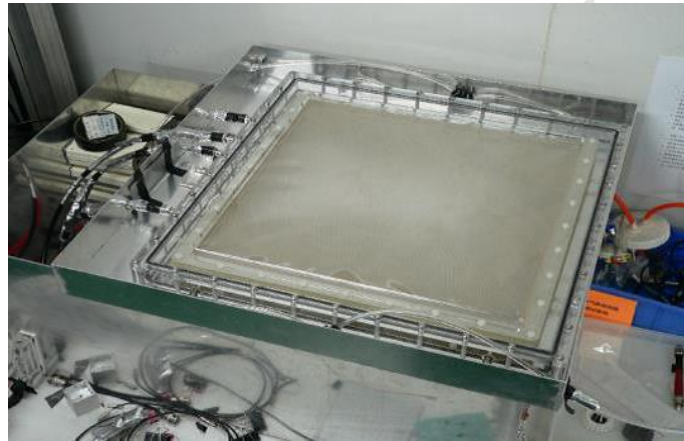

Figure 5.26: A double THGEM was produced with a size of $40 \times 40 \text{ cm}^2$.

1 between the active layers is made of 20 mm thick stainless steel. The thickness of the
 2 readout electronics board is about 3 mm, and the total thickness of a single sensitive layer
 3 is less than 10 mm. Each layer corresponds to about 1.2 radiation lengths and 0.65 nuclear
 4 interaction lengths. The whole DHCAL detector is evenly divided into 40 layers, with a
 5 total stainless steel absorber thickness of 4.7 nuclear interaction lengths.

6 **THGEM prototype** A THGEM with an area of $40 \times 40 \text{ cm}^2$ has been successfully fab-
 7 ricated, as shown in Figure 5.26, and a gain of 2×10^5 has been achieved with a double
 8 THGEM, with an energy resolution of about 20% for an ^{55}Fe source. The THGEM pro-
 9 duced has the following features:

- 10 1. Standard PCB processes are used, which keeps the cost low;
- 11 2. Excellent performance in terms of energy resolution, gas gain and stability (as shown
 12 in Figure 5.25);
- 13 3. Rim around the hole formed by full-etching process, the size of which can be var-
 14 ied between $10 \mu\text{m}$ and $90 \mu\text{m}$, as depicted in Figure 5.25 - this allows adjustment
 15 according to gas requirements.

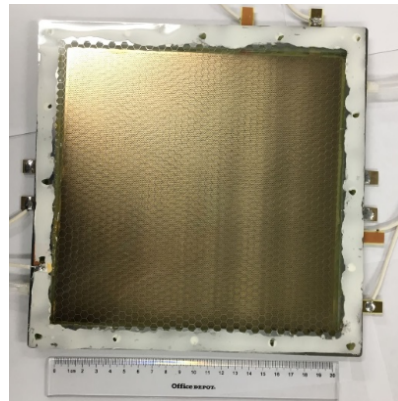
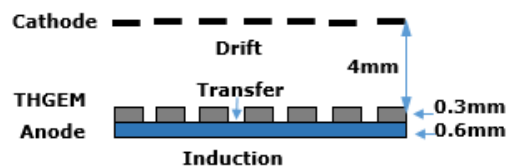

Figure 5.27: The schematic diagram of the WELL-THGEM (left plot), the thickness is 5mm. A $20\text{cm} \times 20\text{cm}$ WELL-THGEM detector was produced (right plot).

1 Figure 5.27 shows the schematic diagram of a new THGEM detector, where a micro-
 2 plate directly attached to the readout plate. Since the micro-porous structure is similar in
 3 shape to a well, these detectors are known as well-type THGEM (WELL-THGEM). This
 4 structure contains a single-layer THGEM, so that the thickness of detector can be reduced
 5 to $4 \sim 5$ mm, and the total thickness of the detector including ASIC electronics could
 6 be lowered to about 6 mm. A $20\text{cm} \times 20\text{cm}$ WELL-THGEM detector using thin-type
 7 THGEM has been developed as shown in the right plot of Figure 5.27

8 In addition, large THGEM detectors have been studied. Single THGEM detectors and
 9 WELL-THGEM detectors are being developed to reduce detector instability and ineffi-
 10 ciency. Gas recycling systems are built to lower gas consumption and pollution. The
 11 achieved THGEM detection rates of 1 MHz/cm^2 with efficiencies greater than 95% al-
 12 ready meet the CEPC requirements.

13 **THGEM digital readout system** A MICRO-mesh gaseous structure Read-Out Chip (MI-
 14 CROROC), which is developed at IN2P3 by OMEGA/LAL and LAPP microelectron-
 15 ics groups was used to readout the THGEM-based SDHCAL. The MICROROC is a 64-
 16 channel mixed-signal integrated circuit based on 350 nm SiGe technology. Each channel
 17 of the MICROROC chip contains a very low noise fixed gain charge preamplifier which is
 18 optimized to cover a dynamic range from 1 fC to 500 fC and allow an input detector capac-
 19 itance of up to 80 pF, two gain-adjustable shapers, three comparators for triple-threshold
 20 readout and a random access memory used as a digital buffer. In addition, the chip has a
 21 10-bit DAC, a configuration register, a bandgap voltage reference, a LVDS receiver shared
 22 by 64 channels and other features. A 1.4 mm total thickness is achieved by using the Thin
 23 Quad-Flat Packaging (TQFP) technology.

24 5.4.3 AHCAL based on Scintillator and SiPM

25 A high-granularity hadronic calorimeter plays an essential role in PFA-based experiments
 26 such as CEPC. It allows separation of the energy deposits from charged and neutral
 27 hadrons. The contribution of the neutrals to the jet energy, around 10% on average, fluctu-
 28 ates over a wide range from event-to-event. Improved resolution on the measurement
 29 of neutrals and therefore on the overall jet energy resolution performance with PFA can
 30 be achieved with analog instrumentation. The AHCAL (Analog Hadron CALorimeter)

1 is a sampling calorimeter with steel as the absorber and scintillator tiles with embedded
 2 electronics. The moderate ratio of hadronic interaction length ($I=17\text{cm}$) to electromag-
 3 netic radiation length ($X_0 = 1.8 \text{ cm}$) of steel, allows a fine longitudinal sampling in terms
 4 of X_0 with a reasonable number of layers. Within the CALICE collaboration, a large
 5 technological prototype [18] using scintillator tiles and SiPMs is currently being built to
 6 demonstrate the scalability to construct a final detector via automated mass assembly. The
 7 outcome of CALICE-AHCAL R&D activities can be an essential input for the conceptual
 8 design of the hadron calorimeter system at CEPC.

9 5.4.3.1 AHCAL geometry and simulation

10 The AHCAL will consist of 40 sensitive and absorber layers, and the total thickness is
 11 about 100 cm. The AHCAL barrel consists of 32 super modules, each super module
 12 consists of 40 layers (Figure 5.28 shows the AHCAL structure). Figure 5.29 shows the
 13 single layer structure of AHCAL. The scintillator tiles wrapped by reflective foil are used
 14 as sensitive medium, interleaved with stainless steel absorber. The thickness of active
 15 layer including the scintillator and electronics is about 4 ~ 5 mm.

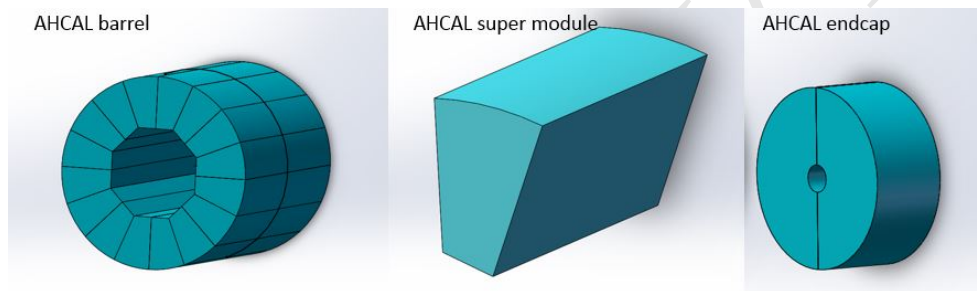

Figure 5.28: The layout of AHCAL barrel (left plot) and endcap regions (right plot), the middle plot shows a super module of AHCAL. The total thickness of AHCAL is about 100cm. The AHCAL barrel consists of 32 super modules, each with 40 layers.

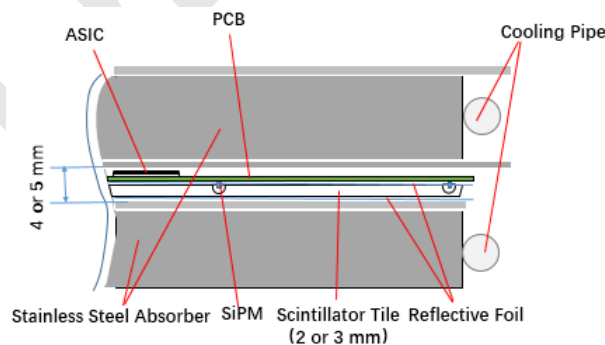

Figure 5.29: Cross-sectional view of a single layer of AHCAL with stainless steel absorber. The thickness of active layer including scintillator and readout electronics is about 5mm.

16 The structure of scintillator tiles is shown in Figure 5.30. A dome-shaped cavity was
 17 processed in the center of the bottom surface of each tile by injection molding technology.
 18 The diameter and height of the cavity [19] are 6mm, 1.5mm, respectively, as shown in
 19 Figure 5.30 (right). Good response uniformity and low dead area will be achieved by the
 20 design of the cavity. More optimizations of the cavity structure will be done by GEANT4
 21 simulation.

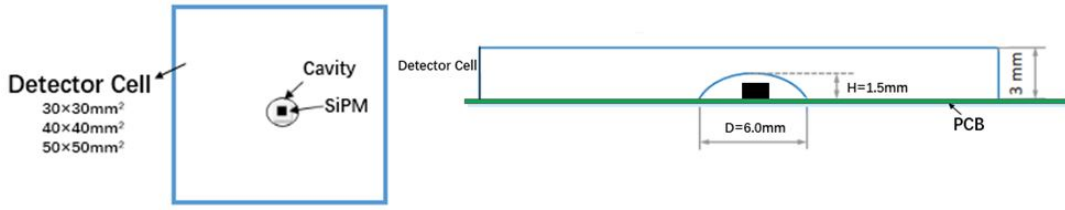

Figure 5.30: Top view of a detector cell (left plot) and cross-sectional view of a detector cell with a dome-shaped cavity (right plot). The detector cell size varies from $30 \times 30 \text{mm}^2$, $40 \times 40 \text{mm}^2$ to $50 \times 50 \text{mm}^2$. The height of dome-shaped cavity in the center of detector cell is 1.5mm with diameter of 6mm.

1 The AHCAL prototype detector was simulated by GEANT4. The detector model
 2 used here was the CEPC_v1 detector model. The geometry information was extracted by
 3 Mokka at runtime and the generated events were stored in Slcio, which contains primary
 4 information regarding the energy deposition, hit position, time and Monte Carlo particle
 5 causing the energy deposition. The ECAL was simulated with 30 layers, and the HCAL
 6 has 40 active layers interleaved with 20 mm stainless steel as absorber plates. Each active
 7 layer consists of plastic scintillator (3mm) and readout layer (2mm PCB). The detector
 8 cell size is $30 \times 30 \times 3 \text{mm}^3$, as shown in Figure 5.31.

9

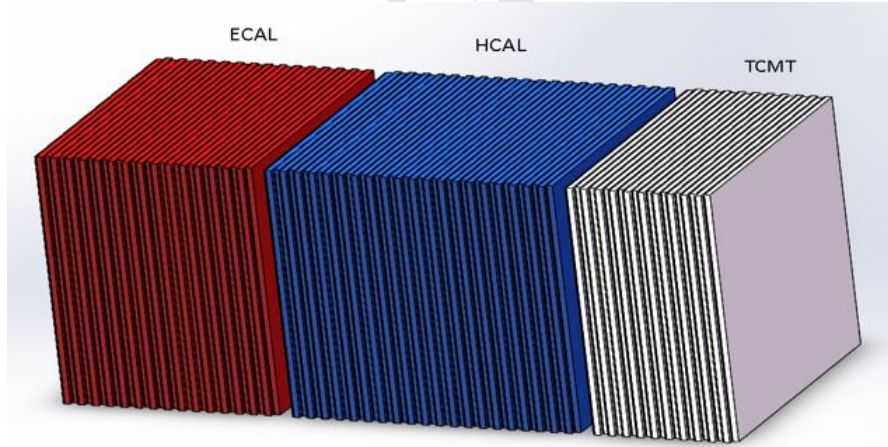

Figure 5.31: The structure of simulated calorimeters which is a part of the simplified geometry. Red part is the Silicon ECAL (30-layer), Blue part is the scintillator AHCAL (40-layer), Grey part is the tail catcher (20-layer).

10 In order to obtain the resolution of calorimeters (ECAL and AHCAL) as shown in
 11 figure 5.31, the energy reconstruction formula 5.3 is employed [20], the coefficients a and
 12 b in this formula represent ECAL and HCAL calibration constants, respectively. After
 13 optimization, the calibration constants are $a=44.4$ and $b=44.2$, respectively, which were
 14 corrected to the energy scale of 60 GeV pions. The calibration constants compensate for
 15 the energy leakage from the calorimeters. The formula 5.4 [20] is used to fit for the energy
 16 resolution, as shown in Figure 5.32.

$$E_{REC} = a \times E_{ECAL} + b \times E_{HCAL} \quad (5.3)$$

$$\frac{\sigma}{E} = \frac{p_0}{\sqrt{E}} + p_1 \quad (5.4)$$

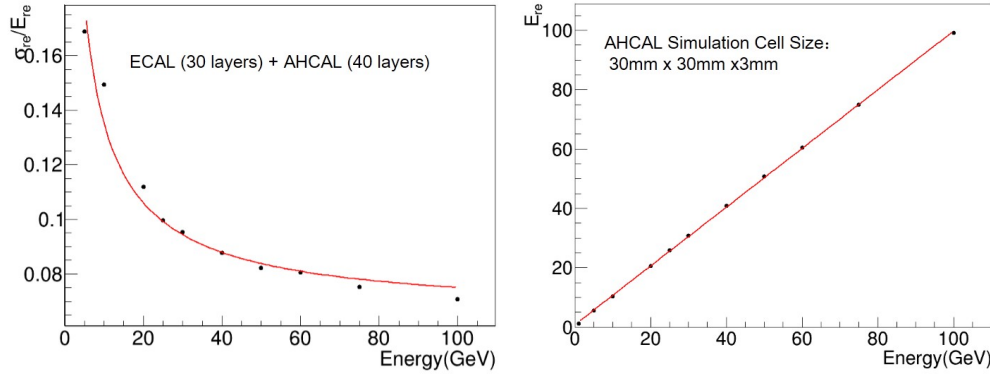

Figure 5.32: The left plot is the energy resolution from the SiW-ECAL and AHCAL for pions. The right plot is the corresponding results of reconstruction energy linearity. The energy resolution is 11% and 8% for energy at 20 GeV and 80 GeV, respectively.

5.4.3.2 Plastic Scintillator detector cell design and test

According to studies by the CALICE collaboration, a scintillator detector cell size of $30 \times 30\text{mm}^2$ is an optimal size. The simulation results of the CALICE collaboration [21] also suggest that it is possible to use the detector cells of larger sizes. A large detector cell size of $40 \times 40\text{mm}^2$ would reduce by nearly half the number of electronics channels compared to the $30 \times 30\text{mm}^2$ size. Therefore, the construction costs can be greatly reduced if the larger detector cells can meet the physics requirements. Two larger sizes of detector cells were considered. Four kinds of scintillator tiles with different sizes were fabricated and tested.

The SiPM is soldered onto a readout Printed Circuit Board (PCB) and the scintillator tile wrapped by ESR reflective foil is directly glued onto the PCB. A cavity design provides enough space for the SiPM package and improves collection efficiency of the light produced by incident particles penetrating the tile at different positions.

A strongly non-uniform tile response can lead to a distortion of the energy reconstruction in a complete calorimeter, and also compromises the calibration of the detector cells based on single particle signals. Three different sizes tiles ($30 \times 30 \times 3\text{mm}^3$, $30 \times 30 \times 2\text{mm}^3$ and $50 \times 50 \times 3\text{mm}^3$) were tested with the Hamamatsu MPPC S12571-025P and S13360-025PE. The spatial distribution of photon equivalents number (p.e.) with different detector cell areas are shown in Figure 5.33. The result shows that the number of p.e. in the center area is slightly larger than that of the surrounding area. The three detector cells show good response uniformity, within 10% deviation from their mean response.

Seven detector cells of different sizes, polishing methods and wrapping foil types were measured. The larger the area of the cell is, the less p.e. are detected, and the results of same size cells varied greatly because of the polishing methods.

The detection efficiency of $30 \times 30 \times 3\text{mm}^3$ and $50 \times 50 \times 3\text{mm}^3$ were measured with cosmic rays. The detection efficiency of $30 \times 30 \times 3\text{mm}^3$ and $50 \times 50 \times 3\text{mm}^3$ cells are 99% and 98.2%, respectively. According the cosmic-ray test result, the detection efficiency of $30 \times 30 \times 2\text{mm}^3$ with S13360-025PE MPPC also can reach 98%.

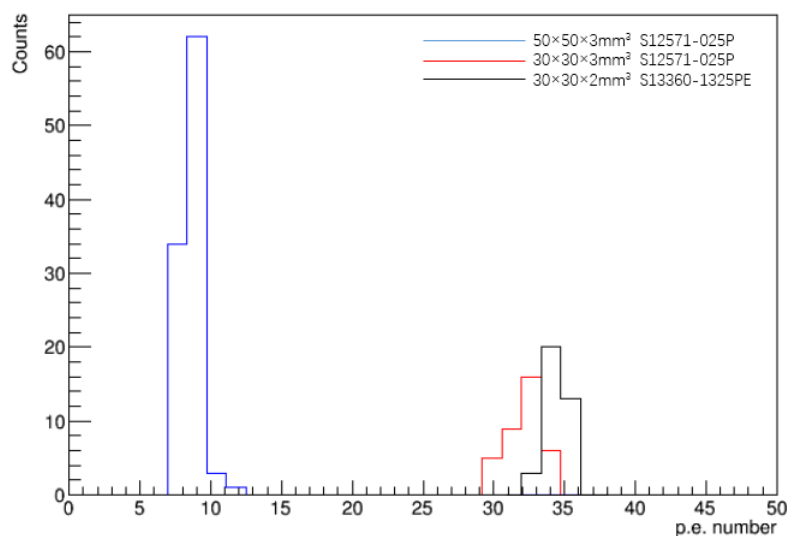

Figure 5.33: The uniformity measurement result of $30\times30\times3\text{mm}^3$ (red histogram, p.e. is about 30-34), $50\times50\times3\text{mm}^3$ (blue histogram, p.e. is about 8-10) and $30\times30\times2\text{mm}^3$ (black histogram, p.e. is about 34-36) detector cell.

The good response uniformity and high detection efficiency results indicate that scintillator detector cells are acceptable for AHCAL. The size of $30\times30\times3\text{mm}^3$ detector cell is the baseline of AHCAL and more optimization of the detector cell size will be done by the simulation and test beam measurements.

5.4.3.3 Development of SiPM

Several kinds of SiPM were developed by Hamamatsu and other companies, they have been used for scintillator ECAL systems. The SiPM with epitaxial quenching resistors (EQR SiPM) is one of the main SiPM technologies under development in China. As shown in Figure 5.34, each APD cell (pixel) forms a high electric field, composing an enriched region between N-type epitaxial silicon substrate and P++ cap layer, and it employs the un-depleted region in the epitaxial silicon layer below P/N junction as the quenching resistor. Compared to conventional SiPM configurations that employ poly-silicon quenching resistors on the device surface, it is easier to achieve high density and small micro-APD cells, thus obtaining a small junction capacitor; the EQR SiPMs are expected to have short recovery time and high counting rate capability.

5.4.3.4 Electronics and DAQ

Front-end electronics ASIC: High-density electronics is indispensable to the instrumentation of high-granularity calorimetry. An ASIC chip named SPIROC, developed by the OMEGA group, is capable of handling 36 SiPMs. For each channel, it can be operated in an auto-trigger mode and has a dual-gain charge preamplifier with high dynamic range. It allows to measure the charge from 1 to 2000 photo-electron and the time to within 1 ns using a 12-bit digitizing circuit. With one 8-bit 5V input DAC per channel, the bias voltage for each SiPM can be adjusted to reach its optimum. In each channel, there are 16 analog memory cells that can buffer both charge and timing signals to be digitized afterwards consecutively. The digitization circuit is shared for both charge and timing measurements to minimize the power consumption, which needs to be as low as $25\ \mu\text{W}$ per channel.

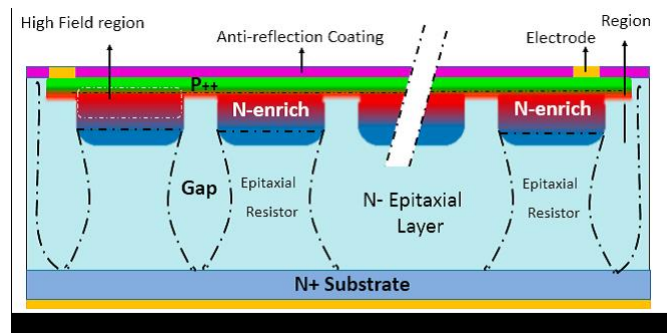

Figure 5.34: Schematic structure of EQR SiPM. APD cell consists of N-enriched regions forming high electric fields between the N-type epitaxial silicon wafer and the P++ surface layer, the un-depleted region in the epitaxial silicon layer below the P/N junction as the quenching resistor. The APD cells are isolated from each other by the Gap depletion region.

5.4.3.5 Cooling system

Inside the active layers of the calorimeter, the total power consumption of SPIROC ASIC chip and SiPM is about 5 mW/channel [22]. The scintillator detector cell size is $30 \times 30 \text{ mm}^2$, and the total channel number is about 5 million. For whole AHCAL, the total power consumption from ASIC chips is about 30kW. The copper cooling water pipes are expected to be embedded in the stainless steel absorber. The cooling pipes are in the layer structure, as shown in Figure 5.29. Detailed design and optimization of a cooling system is needed.

5.5 Dual-readout calorimetry

5.5.1 Introduction

The dual-readout approach envisages designing a combined, homogeneous, detector with excellent performance for both electromagnetic and hadronic particle showers.

With conventional calorimeters, the performance obtained in hadronic energy measurements is by far worse than for the electromagnetic ones. The origin of this disparity is in the showers from single hadrons or jets of hadrons. Hadronic showers develop an electromagnetic component, from π^0 and η production, that exhibits large event-by-event fluctuations and dependence on the particle type and energy [23]. The *em* and non-*em* components of a hadronic shower are normally sampled with very different sensitivity, producing large differences in the measured signals, heavily affecting the energy resolution capability.

The variation of the *em* fraction is intrinsic to hadronic showers. As a matter of fact, the *em* fraction depends on the kind of particle initiating the shower (e.g., π , K , p) since, for example, impinging π^\pm mesons can undergo a charge-exchange reaction with a nucleon as first interaction and generate a pure *em* shower, while a p cannot do the same due to baryon number conservation. Moreover, since π^0 production happens at any stage of shower development, the average *em* fraction $\langle f_{em} \rangle$ increases with the energy as well as with the depth ("age") of the shower.

To overcome the problem two methods have been exploited: compensation and dual readout (DR). The first relies on equalizing the detector response to electromagnetic (*e*) and non-electromagnetic (*h*) shower particles (i.e. $h/e = 1$), but this requires a fixed ratio of absorber-to-sensor volumes, which limits the electromagnetic energy resolution, and

1 the integration of the signals over large volumes and long times, to increase the response
 2 to the h component. The dual-readout method avoids these limitations by directly mea-
 3 suring f_{em} on an event-by-event basis. The showers are sampled through two independent
 4 processes, namely scintillation (S) and Čerenkov (C) light emissions. The former is sen-
 5 sitive to all ionizing particles, while the latter is produced by highly relativistic particles
 6 only, almost exclusively found inside the em shower component. By combining the two
 7 measurements, energy and f_{em} of each shower can be simultaneously reconstructed. The
 8 performance in hadronic calorimetry may be boosted toward its ultimate limit.

9 The results obtained so far with prototypes, support the statement that fiber-sampling
 10 DR calorimeters may reach resolutions of the order of $10\%/\sqrt{E}$ or better for em showers
 11 and around $30 - 40\%/\sqrt{E}$ for hadronic showers and jets, coupled with strong standalone
 12 particle identification (PID) capabilities. One of the strengths of a DR calorimeter is that
 13 it achieves excellent jet energy resolution while not sacrificing performance in electro-
 14 magnetic energy measurements. This would allow $W \rightarrow jj$ separation from $Z \rightarrow jj$ by
 15 invariant mass, high-precision missing three-momentum reconstruction by subtraction,
 16 $e-\mu-\pi$ separation and particle tagging.

17 While the dual-readout concept has been extensively demonstrated and experimen-
 18 tally validated in a series of beam tests, the use of standard PhotoMultiplier (PM) tubes to
 19 readout the S and C light has so far limited its development towards a full-scale system
 20 compliant with the integration in a particle detector at a colliding beam machine. These
 21 limitations should be overcome using SiPMs, low-cost solid-state sensors of light with
 22 single photon sensitivity, magnetic field insensitivity and design flexibility.

23 As it will be shown in the following, the high readout granularity in the plane perpen-
 24 dicular to the shower development and few other signal properties will probably make re-
 25 dundant or even inessential the need of a longitudinal segmentation into em and hadronic
 26 compartments (that is anyway possible). In case of a segmented calorimeter, both com-
 27 partments need to provide dual-readout signals, in order to allow for the measurement of
 28 $\langle f_{em} \rangle$.

29 5.5.2 Principle of dual-readout calorimetry

30 The independent sampling of hadronic showers, through scintillation and Čerenkov light
 31 emission, allows one to fully reconstruct, at the same time, energy and f_{em} of hadronic
 32 showers. In fact, the total detected signals, measured with respect to the electromagnetic
 33 energy scale, can be expressed as:

$$S = E [f_{em} + \eta_S \cdot (1 - f_{em})] \quad (5.5)$$

34

$$C = E [f_{em} + \eta_C \cdot (1 - f_{em})] \quad (5.6)$$

35 where $\eta_S = (h/e)_S$ is the ratio of the average S response for the non- em component to
 36 the em component in hadronic showers. The response being defined as the average signal
 37 per unit of deposited particle energy. The parameter $\eta_C = (h/e)_C$ is the response ratio for
 38 the C signal. In a typical dual-readout calorimeter, $\eta_S \approx 0.7$ and $\eta_C \approx 0.2$. These two
 39 equations are easily solved giving:

$$\frac{C}{S} = \frac{[f_{em} + \eta_C \cdot (1 - f_{em})]}{[f_{em} + \eta_S \cdot (1 - f_{em})]} \quad (5.7)$$

$$E = \frac{S - \chi C}{1 - \chi} \quad (5.8)$$

where:

$$\chi = \frac{1 - \eta_S}{1 - \eta_C} = \cot \theta \quad (5.9)$$

This is the simplest formulation of hadronic calorimeter response: an em part with relative response of unity, and a non- em part with relative response η .

There are two unknowns for each shower, E and f_{em} , and two measurements, S and C . The electromagnetic fraction, f_{em} , is determined entirely by the ratio C/S , and the shower energy calculated as in Eq. 5.8. Both, S and C , $\eta = (h/e)$ ratios have event-by-event fluctuations and should be considered stochastic variables, nevertheless the average $\langle h/e \rangle$ values are essentially independent of hadron energy and species [24–26]. The global parameter χ can be extracted with a fit to calibration data:

$$\chi = \frac{E_0 - S}{E_0 - C} \quad (5.10)$$

$$S = (1 - \chi)E_0 + \chi C \quad (5.11)$$

where E_0 is the beam energy.

The geometrical meaning of the θ angle in Eq. 5.9 can be understood by looking at the scatter plot of C versus S signals in Figure 5.35. An illustration of the prediction for the scatter plot for protons and pions is shown in Figure 5.35(a) and the scatter plot for 60 GeV pions measured in the RD52 lead-fiber calorimeter is shown in Figure 5.35(b).

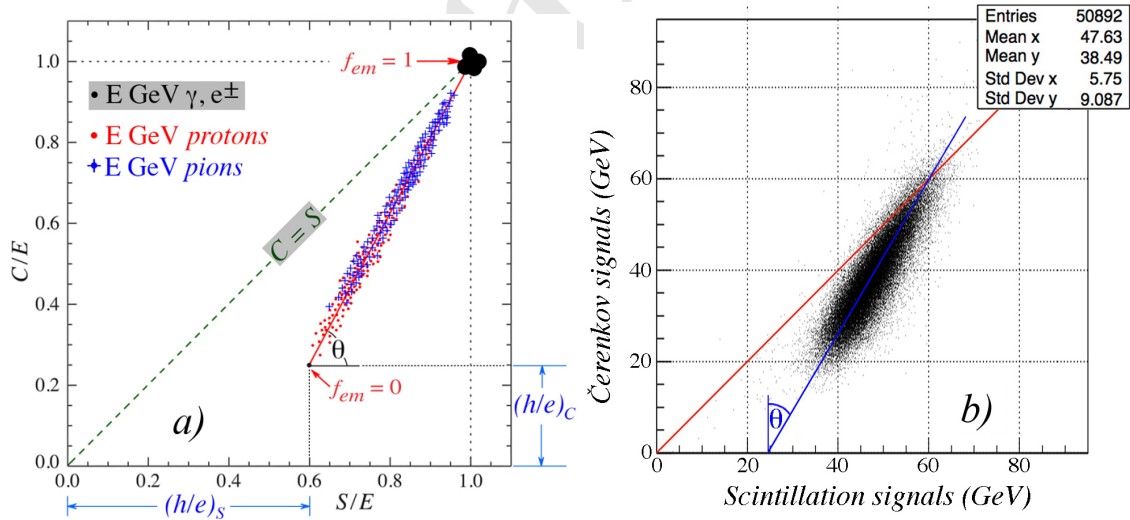

Figure 5.35: (a) Scatter plot of C/E versus S/E in a dual-readout calorimeter for p and π ; (b) scatter plot of C and S signals for 60 GeV pions in the RD52 lead-fiber calorimeter.

The plot in Figure 5.35(b) shows that the data points are located on a locus, clustered around a line that intersects the $C/S = 1$ line at the beam energy of 60 GeV. In first approximation, the signal generated in the Čerenkov fibers is produced only by the em components of the hadron showers. The smaller the em fraction f_{em} , the smaller the C/S signal ratio. All signals are relative to the em scale meaning that both the Čerenkov

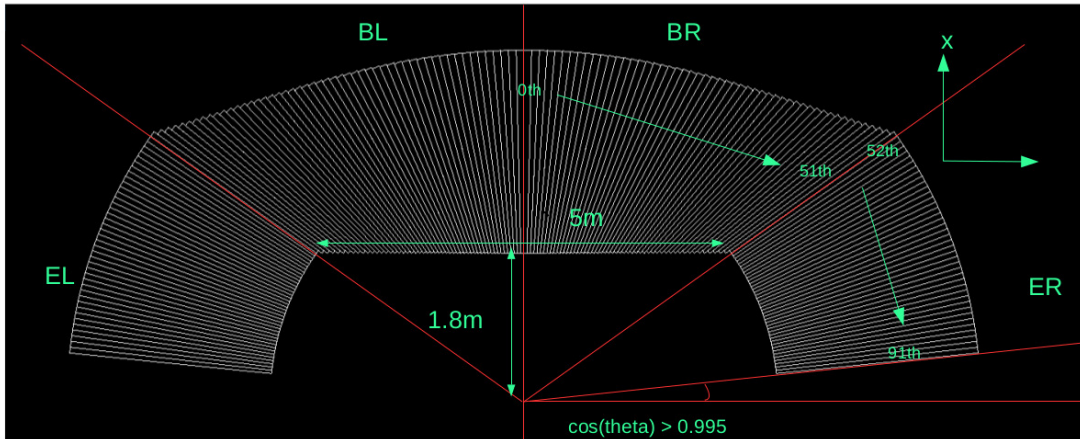

Figure 5.36: A possible 4π solution (called "wedge" geometry).

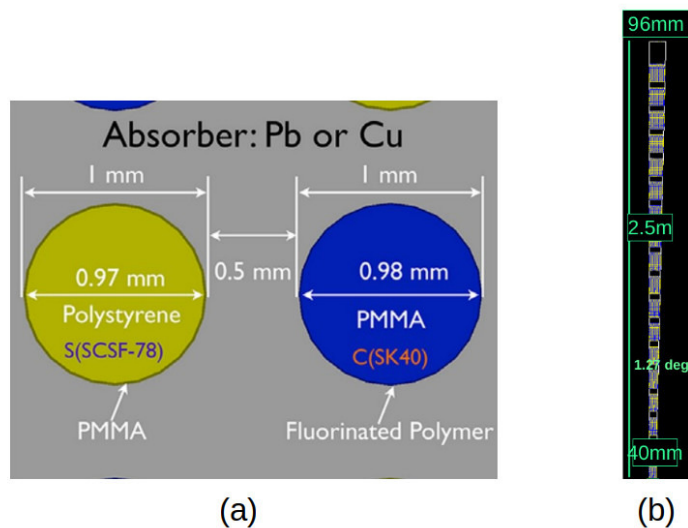

Figure 5.37: (a) Fiber arrangement inside the modules. (b) Dimensions of a module in the barrel region (at $\eta = 0$): from inside to outside the number of fibers more than doubles.

1 and the scintillation responses are calibrated with beam electrons only, i.e. no hadronic
 2 calibration is required. This is one of the most qualifying and important points of dual-
 3 readout calorimetry.

4 The effectiveness of this approach has been demonstrated by the DREAM/RD52 col-
 5 laboration over a 15-year research program with a variety of detector solutions. Results
 6 and simulations [27–32] provide, so far, confidence that a fiber-sampling calorimeter, even
 7 without longitudinal segmentation, may meet the requirements of the CEPC physics pro-
 8 gram in a cost-effective way. Linearity and energy resolution, for both em and hadronic
 9 showers, $e/\pi/\mu$ separation, spatial resolution, all show adequate performance.

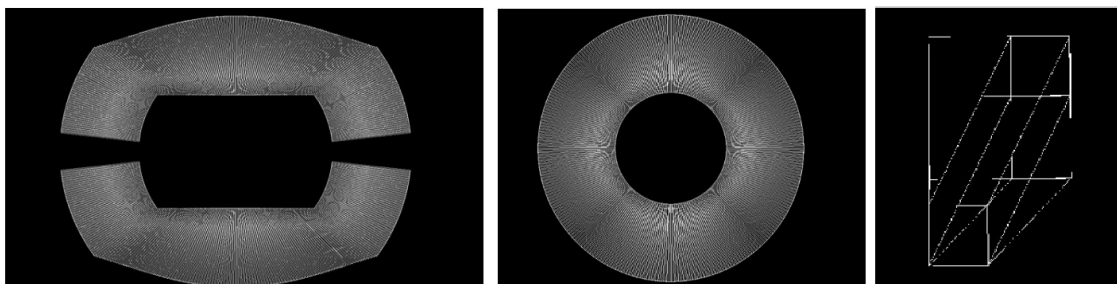

Figure 5.38: An alternative 4π solution (called "wing" geometry).

5.5.3 Layout and mechanics

5.5.3.1 Layout

A possible projective layout ("wedge" geometry, Figure 5.36) has been implemented in the simulations. Based on the work done for the 4th Detector Collaboration (described in its Letter of Intent [33]), it covers, with no cracks, the full volume up to $|\cos(\theta)| = 0.995$, with 92 different types of towers (wedges). A typical one in the barrel region is shown in Figure 5.37(b), together with the fiber arrangement (Figure 5.37(a)): it has a granularity of $\Delta\theta \times \Delta\phi = 1.27^\circ \times 1.27^\circ$, a depth of about 250 cm ($\sim 10 \lambda_{\text{Int}}$), and contains a total of about 4000 fibers. The sampling fraction is kept constant by fibers starting at different depths inside each tower. This layout has been already imported in the simulations for the CEPC detector. Preliminary results on performance are shown in the next chapters.

A different layout implementing the "wing" geometry (see Figure 5.38) is also under study and preliminary results on the em performance will also be shown in the next chapters. In this case, the calorimeter is made of rectangular towers coupled with triangular ones.

In both cases, the total number of fibers is of the order of 10^8 for a complete 4π calorimeter.

5.5.3.2 Mechanics (material choice and machining)

Copper, lead and brass (Cu260) have been used as absorber materials by the DREAM/RD52 collaboration. Their main properties are shown in the Table 5.3, that also reports the calculation for the RD52 lead-prototype geometry. The values for iron are also shown, for comparison. From the table it can be seen that, for hadronic showers, a full-coverage solution with lead will give 6% broader and longer showers and a total mass 56% heavier than using brass. A full-containment $3 \times 3 \times 10 \lambda^3$ prototype will need ~ 5 tons of material with lead and ~ 3.2 tons with brass.

A possibly stronger reason in favor of copper/brass is the fact that, since the e/mip ratio is 50% higher for copper than for lead, the Čerenkov light (almost exclusively produced by the em component of the shower) has a larger yield for copper, resulting in a better hadronic resolution [23]. However this statement needs to be quantified since it depends on the absolute level of the Čerenkov light yield(s).

On the other hand, lead is easily and accurately extruded, whereas forming copper into the desired shape, either by extrusion, molding, or machining, with the required tolerances in planarity and groove parallelism, is not yet an established industrial process. A variety of techniques (extrusion, rolling, scraping, and milling) for forming the con-

<i>material</i>	ρ (g/cm ³)	X_0 (cm)	$R_{\text{Molière}}$ (cm)	λ_{Int} (cm)	$\rho \times \lambda_{\text{Int}}^3$ (kg)
Copper (Cu)	8.96	1.44	1.57	15.3	32.2
Brass (Cu260)	8.53	1.49	1.64	16.4	37.8
Lead (Pb)	11.35	0.56	1.60	17.6	61.8
Iron (Fe)	7.874	1.76	1.72	16.8	37.1
Fibers:Copper (38:62)	5.98	2.26	2.28	21.9	62.8
Fibers:Brass (38:62)	5.72	2.35	2.38	23.3	72.1
Fibers:Lead (38:62)	7.46	0.90	2.33	24.7	112.8
Fibers:Iron (38:62)	5.31	2.75	2.48	23.7	70.8

Table 5.3: Main properties of lead, copper, brass and iron absorber material and of fiber sampling matrices (RD52 lead-fiber prototype geometry).

1 verter layers have been tested. None has been qualified for a large-scale production and
2 identifying an industrial and cost-effective process, including moulding, is a key point.

3 Alternative copper alloys (e.g. bronze) and/or materials (e.g. iron) may be investi-
4 gated as well, both for addressing the production process issues and for optimizing the
5 detector performance.

6 **5.5.4 Sensors and readout electronics**

7 To separately read out the signals from the S and C fiber forest and avoid oversampling
8 of late developing showers is an issue that may be successfully addressed through the use
9 of Silicon PhotoMultipliers (SiPMs). They would allow the separate reading of each fiber
10 and provide magnetic field insensitivity. In principle, assuming powering and cooling do
11 not pose issues, the transverse segmentation could be made as small as a fiber spacing, or
12 1.5 mm.

13 SiPMs are low-cost solid state light sensors with single photon sensitivity that under-
14 went an impressive development over the last few years. Tests done in the last two years
15 by the RD52 collaboration indicate that effective solutions for small-scale prototypes are
16 very close already now. Thanks to their higher photon detection efficiency with respect to
17 a standard PM, the higher number of Čerenkov (pe) should result in an improved resolu-
18 tion for both em and hadronic showers. On the other hand, the scintillation light spans a
19 very large dynamic range and saturation and non-linearity effects were observed already
20 for low-energy em showers.

21 In Figure 5.39, the number of photoelectrons per GeV (pe/GeV) measured, in July
22 2017, with a very small module ($\sim 1.44 \text{ cm}^2$ cross section, 32 + 32 fibers), is shown. The
23 most relevant sensor characteristics are 1600, $25 \times 25 \mu\text{m}^2$, cells, and a 25% nominal
24 PDE. Due to the large S light yield, the data for the S signal were obtained at an (ultra
25 low) PDE of $\sim 2\%$, and corrected for non-linearity. Rescaled to a 25% efficiency, the yield
26 of S photoelectrons results in $\sim 108 \times 12.5 = 1350 \text{ pe/GeV}$. By removing from the sum
27 the hottest fiber, more heavily affected by non-linearity effects, the estimate grows to
28 $\sim 1530 \text{ pe/GeV}$.

29 The C signals show a linear response at $\sim 30 \text{ pe/GeV}$. It should be mentioned
30 that the shower containment was estimated from GEANT4 simulations to be $\sim 45\%$. In

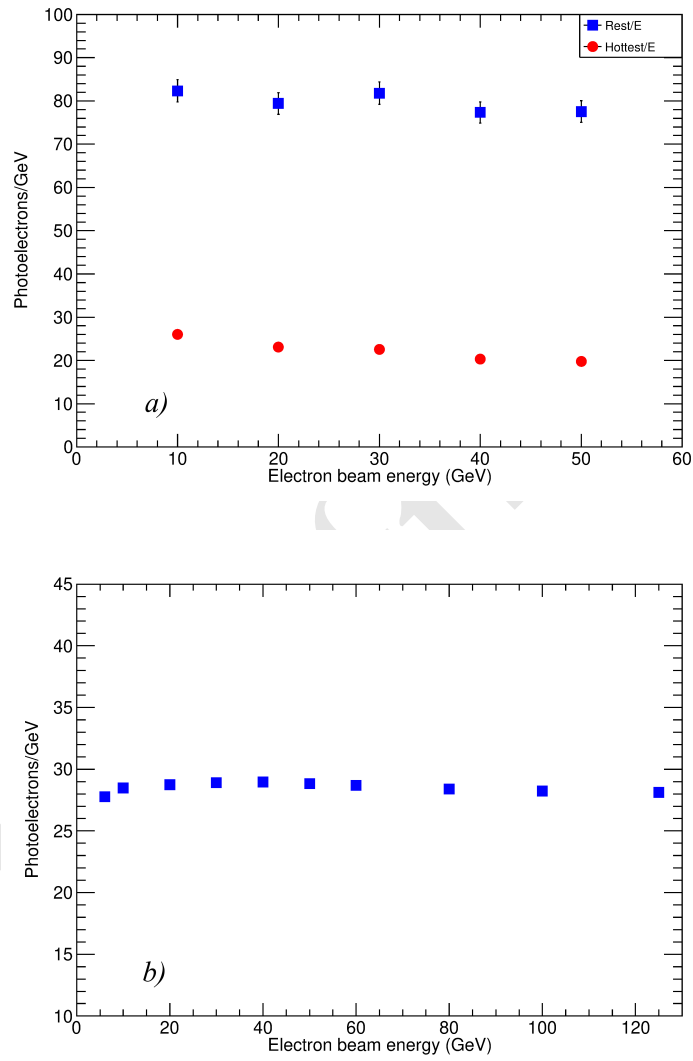

Figure 5.39: Number of photoelectrons per GeV (pe/GeV) for (a) *S* and (b) *C* signals, as a function of the electron energy, from 10 to 50 GeV, in a small 64-fiber brass module. In (a), the results are shown separately for the hottest fiber and for the sum of the signals measured by the other 31 scintillating fibers obtained at the (ultra low) PDE of $\sim 2\%$. The main sensor specifications were: 1600, $25 \times 25 \mu\text{m}^2$, cells, and a 25% nominal PDE.

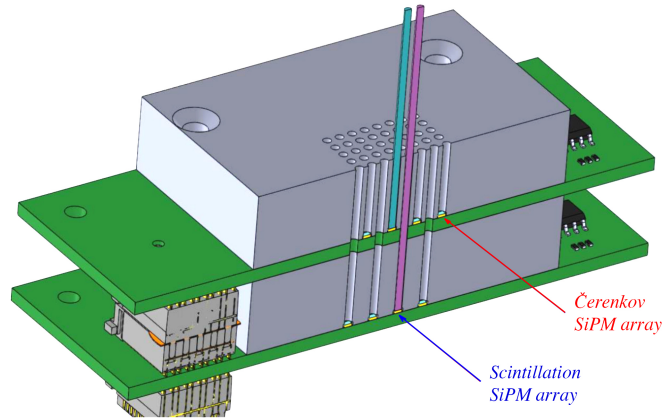

Figure 5.40: Staggered readout scheme: the scintillation and Čerenkov fibers are readout at different planes to minimize light leakage into neighboring channels.

1 addition, the problem of large light leaks from the *S* fibers into the neighboring *C* SiPM
 2 channels, observed in the 2016 tests, seems to be largely but not completely solved by a
 3 staggered readout of the *S* and *C* fibers (Figure 5.40). The contamination of the *C* signal
 4 was estimated to be $\sim 16\% \pm 6\%$.

5 5.5.4.1 Sensor choice

6 As far as the scintillation light detection is concerned, saturation and non-linearity should
 7 be solvable using higher density devices (e.g. with 10000, $10 \times 10 \mu\text{m}^2$, cells) in com-
 8 bination with some light filtering. The definition of the optimal dynamic range and the
 9 qualification of existing SiPMs in that regard, will be likely addressed in a short-term
 10 R&D phase.

11 For the Čerenkov light, improvements of the photon collection are possible with the
 12 use of an aluminized mirror on the upstream end of the fibers. The acceptance cone may
 13 also be enlarged with the use of cladding with a different refractive index. Over a longer
 14 term, it could be possible that the R&D on new devices, such as Silicon Carbide (SiC)
 15 sensors, expected to provide exclusive UV sensitivity (i.e. visible-light blindness), will
 16 allow us to obtain significantly larger *pe* yields.

17 5.5.4.2 Front-end electronics and readout

18 Concerning the front-end, the development shall certainly evaluate the use of Application
 19 Specific Integrated Circuits (ASIC) to handle and reduce the information to be transferred
 20 to the DAQ system. A major question is finding the optimal way for summing signals
 21 from a plurality of sensors into a single output channel. A dedicated feature-extracting
 22 processor, capable of extracting timing information such as time-over-threshold, peaking,
 23 leading and/or falling times, may allow to disentangle overlapping *em* and hadronic show-
 24 ers without the need for longitudinal segmentation. With the present fibers, a resolution
 25 of the order of 100 ps corresponds to a spatial resolution of about ~ 6 cm along the fiber
 26 axis (relativistic particles take 200 ps to cover 6 cm while light needs 300 ps).

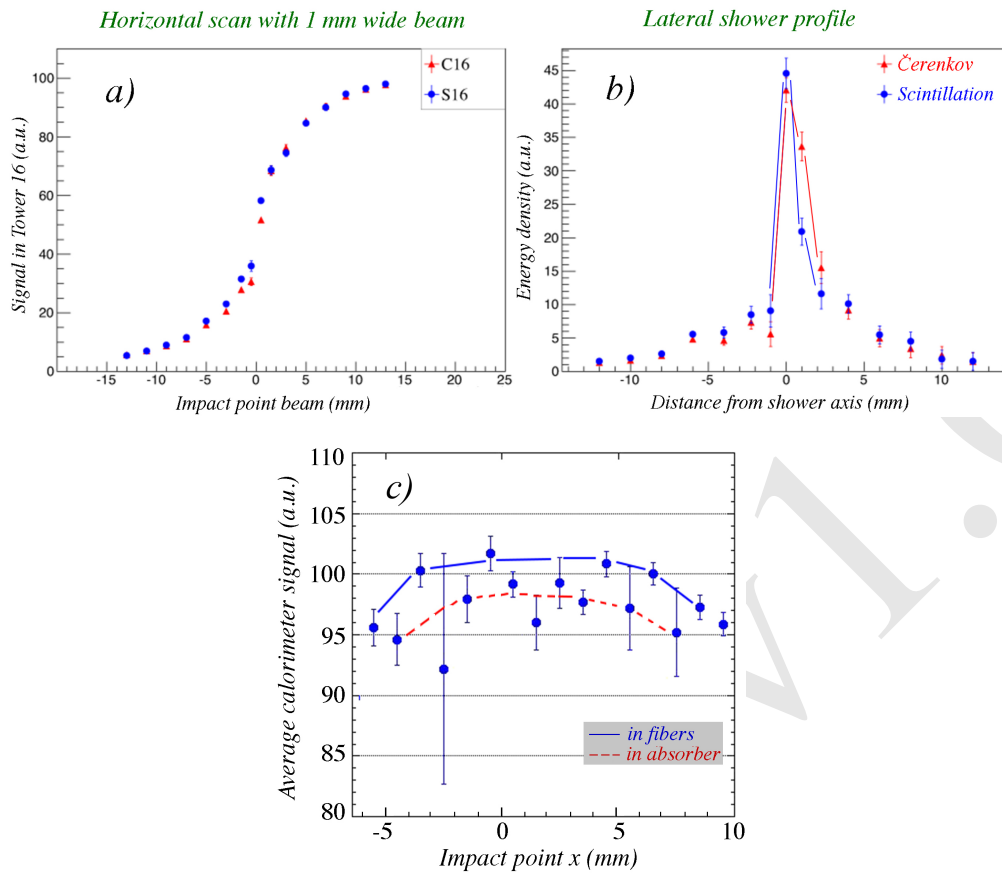

Figure 5.41: (a) The signal from a 1 mm wide beam of 100 GeV electrons, in the RD52 lead-fiber prototype, as a function of the impact point; (b) the lateral shower profiles derived from this measurement; (c) the dependence of the scintillation signal on impact point for a beam impinging parallel to the fibers.

5.5.5 Performance studies with fiber-sampling prototypes

Different prototypes were built and studied by the DREAM/RD52 collaboration, with copper or lead as absorber and photomultipliers as light sensors [27–32]. With electrons and pions, in the range of ~ 10 -150 GeV, the response linearity was found at the level of 1% for both the *em* and the hadronic energy reconstruction (having applied the dual-readout formula, equation 5.8, for hadronic showers). The *em* resolution was estimated to be close to $\sim 10\%/\sqrt{E}$, while the hadronic resolution was found to be at the level of 60 - $70\%/\sqrt{E}$, to be corrected for the fluctuations introduced by lateral leakage and light attenuation in the fibers. None of the prototypes built thus far were large enough to substantially contain hadronic showers and an R&D program to assess the hadronic performance of a real detector, is under way. Preliminary simulations of standalone modules indicate a possible ultimate resolution of ~ 30 – $40\%/\sqrt{E}$. More details can be found in the next paragraphs.

5.5.5.1 Electromagnetic performance

Figure 5.41(a) and 5.41(b) show the radial shower profile and the sensitivity to the impact point: the core of the signal spans just a few mm. Figure 5.41(c) shows the dependence of the *S* signal on the impact point for particles entering parallel to the fibers. This introduces a constant term in the resolution that can be avoided with a small tilt of the fiber axis. In

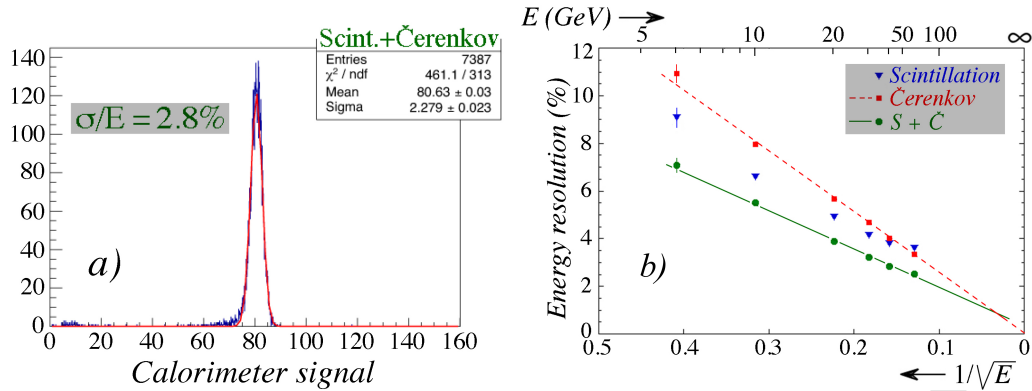

Figure 5.42: In the RD52 copper-fiber module: (a) signal distribution of the sum of all fibers for 40 GeV electrons; (b) the em energy resolution as a function of the beam energy. Shown are the results for the two types of fibers, and for the average combined signal.

1 the C fibers, the problem does not show up since the early (collimated) part of the shower
 2 produces photons outside the fiber numerical aperture.

3 For the reconstruction of the energy of em showers, S and C signals provide inde-
 4 pendent uncorrelated measurements, with different sensitivity of the response. They are
 5 affected by different problems: S signals have photoelectron statistics one or two orders
 6 of magnitude higher than C signals, and their fluctuations are largely dominated by the
 7 sampling fluctuation of the energy deposits. C signal fluctuations are generally dominated
 8 by the limited photoelectron statistics, especially at low energies. Nevertheless, at high
 9 energies, the constant term for C signals is negligible, giving a better resolution. Averag-
 10 ing the two measurements improves the resolution up to a factor of $\sqrt{2}$. For the copper
 11 matrix, in Figure 5.42(a) the sum of S and C signals for 40 GeV electrons is plotted, while
 12 Figure 5.42(b) shows the em resolution, for S , C and the (average) combined signal.

13 5.5.5.2 Hadronic performance

14 The response of a lead-fiber matrix was studied with pion and proton beams [32]. The
 15 energy was reconstructed with the dual-readout relation (Eq. 5.8) and shows a restored
 16 gaussian response function (Figure 5.43) and linearity of the mean response.

17 The comparison of p and π^+ signals confirms that the dual-readout method largely
 18 compensates for the differences in shower composition, i.e., differences in the electromag-
 19 netic fraction, f_{em} , and between baryon-initiated and pion-initiated hadronic showers.

20 Due to the limited lateral size of the matrix (the effective diameter was $\sim 1\lambda_{\text{Int}}$),
 21 the containment for hadronic showers was $\sim 90\%$ so that leakage fluctuations dominated
 22 the energy resolution. Selecting contained showers improved the resolution by a factor
 23 of ~ 2 . Although that selection was introducing a bias in favor of high f_{em} showers, a
 24 significant improvement is expected for a realistic-size module.

25 The resolution was also affected by the finite light attenuation length of the fibers,
 26 causing early starting showers to be observed at lower signal values. The hadronic reso-
 27 lution, yet to be corrected for both effects, was reconstructed to be $\sim 70\%/\sqrt{E}$.

28 5.5.5.3 e/π separation

29 Four discriminating variables were identified for implementing e/π separation: the frac-
 30 tion of energy in the central tower, the C/S signal ratio, the signal starting time and the

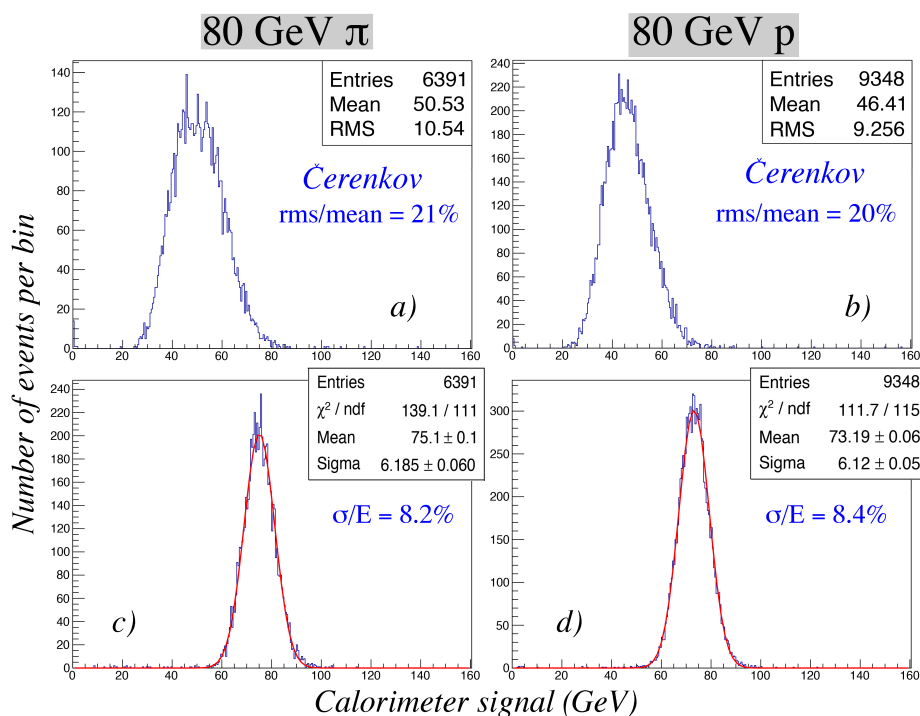

Figure 5.43: Signal distributions for 80 GeV pions and protons measured with the RD52 lead-fiber calorimeter. Shown are the distributions for the Čerenkov signals from 80 GeV (a) π^+ and (b) protons, as well as the dual-readout total signals for 80 GeV (c) π^+ and (d) protons. The dual-readout signals were obtained by applying Equation 5.8 with $\chi = 0.45$.

1 total charge/amplitude ratio, shown in Figure 5.44. The plots are relative to testbeam data
 2 taken with the RD52 lead-fiber prototype [27].

3 A multivariate neural network analysis showed that the best e/π separation achiev-
 4 able for 60 GeV beams was 99.8% electron identification efficiency with 0.2% pion
 5 misidentification. Further improvements may be expected by including the full time struc-
 6 ture information of the pulses, especially if the upstream ends of the fibers are made re-
 7 flective.

8 5.5.6 Monte Carlo simulations

9 GEANT4 simulations¹ are under development and analysis for understanding the perfor-
 10 mance of both testbeam modules and a 4π calorimeter integrated in a detector, with mag-
 11 netic field, tracking and preshower elements.

12 5.5.6.1 Electromagnetic performance

13 A Cu matrix of dimensions $\sim 31 \times 31 \times 100 \text{ cm}^3$, with 1 mm fibers at 1.4 mm distance,
 14 compatible with the RD52 prototypes, has been simulated for the evaluation of the electro-
 15 magnetic performance. PMMA clear fibers and Polystyrene scintillating fibers, with a 3%
 16 thick cladding (C_2F_2 Fluorinated Polymer for clear and PMMA for scintillating fibers),
 17 were the sensitive elements.

¹version 10.02.p01-10.03.p01, with FTFP_BERT_HP physics list

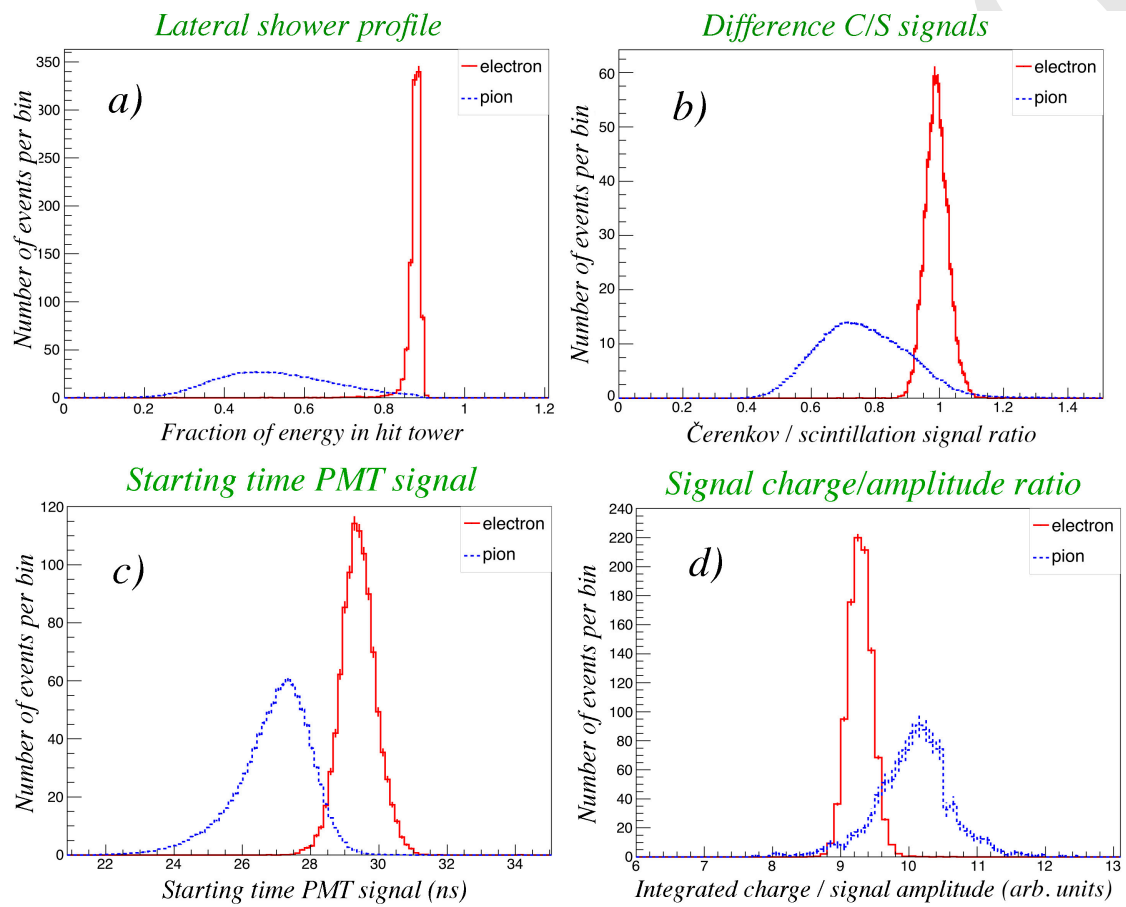

Figure 5.44: Distribution of four discriminating variables for 60 or 80 GeV electrons and pions, as measured with the RD52 lead-fiber prototype: (a) energy fraction deposited in the hit tower; (b) C/S signal ratio in the hit tower; (c) starting time of the PM signal; (d) ratio of the integrated charge and the amplitude of the signals.

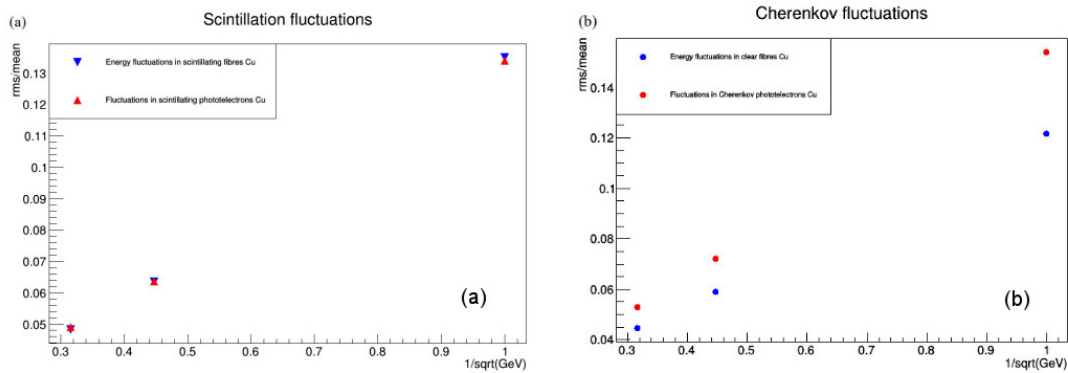

Figure 5.45: Relative fluctuation of the total signal detected in the (a) scintillating and (b) Čerenkov fibers, for both the energy deposit and the number of photoelectrons (MC simulations).

1 A small ($\lesssim 1^\circ$) tilt angle was introduced to avoid large non-Gaussian tails in the
2 scintillation signal due to channeling.

3 The energy containment for 20 GeV electrons was estimated to be $\geq 99\%$, with
4 sampling fractions of 5.3% and 6.0% for scintillating and clear fibers, respectively.

5 Given the integral sampling fraction of 11.3% and the 1 mm diameter fibers, the
6 contribution to the energy resolution due to sampling fluctuations can be estimated to be
7 $\sim 9\%/\sqrt{E}$, ultimate limit on the em resolution for this detector.

8 The scintillation light yield is so large ($\sim 5500 pe/GeV$) that the fluctuations of
9 the S signals are dominated by the energy sampling process (Figure 5.45(a)). This is
10 not true for the Čerenkov signals (Figure 5.45(b)), whose sensitivity is estimated to be
11 $\sim 100 pe/GeV$.

12 In the simulations, the process of generation and propagation of the scintillation light
13 was switched off and the energy deposited in the fibers was taken as signal since this
14 does not introduce any bias to the detector performance. This statement does not apply
15 to the Čerenkov photons for which a parameterization that convolutes the effect of light
16 attenuation, angular acceptance and PDE, was introduced.

17 In Figure 5.46 the resolutions are shown for both C and S signals, separately, and
18 for the unweighted average value of the two. The variable on the horizontal axis and in
19 the formulae for the fitted resolutions is the beam energy. The results of the fit to the data
20 points are shown in Table 5.4. A slightly better result may be obtained with a weighted
21 average.

22 5.5.6.2 Hadronic performance

23 A simulation of larger ($\sim 72 \times 72 \times 250 cm^3$) matrices was implemented in order to get
24 a hadronic shower containment of $\sim 99\%$. Calibration was done with 40 GeV electron
25 beams.

26 In Figure 5.47 GEANT4 predictions for the hadronic energy resolution, with copper
27 absorber, are shown. Table 5.5 lists the results of the fit to the curves.

28 The large constant terms, for both S and C signals, are generated by the f_{em} corre-
29 lated fluctuations. Simulations with lead absorber give equivalent but even slightly better
30 results. The energy E in the plot (and in the expressions for the fitted resolutions) is
31 the beam energy, corresponding in average to the energy reconstructed with the Equa-

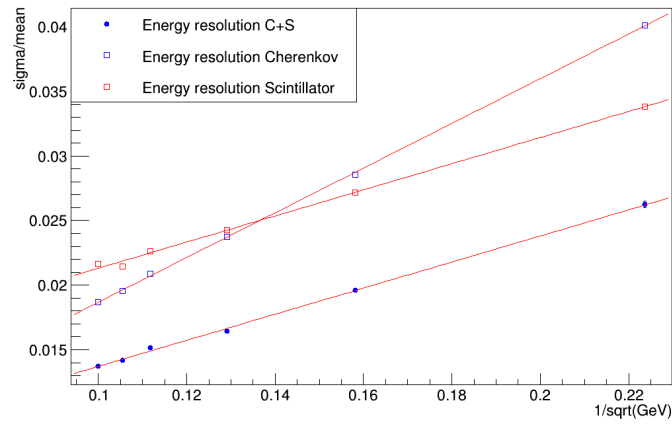

Figure 5.46: Relative resolution for em showers for the C and S signals, independently, and for the average of the two (MC simulations).

<i>fibers used</i>	Fitted Gaussian <i>em</i> energy resolution
S-fibers only	$\sigma/E = 10.1\%/\sqrt{E} \oplus 1.1\%$
C-fibers only	$\sigma/E = 17.3\%/\sqrt{E} \oplus 0.1\%$
S-fibers and C-fibers	$\sigma/E = 10.1\%/\sqrt{E} \oplus 0.4\%$

Table 5.4: Fit to the em resolution (MC simulations)

<i>fibers used</i>	Fitted Gaussian hadronic energy resolution
S-fibers only	$\sigma/E = 30\%/\sqrt{E} \oplus 2.4\%$
C-fibers only	$\sigma/E = 73\%/\sqrt{E} \oplus 6.6\%$
Dual-readout S-fibers and C-fibers	$\sigma/E = 34\%/\sqrt{E} \oplus (\text{negligible})\%$

Table 5.5: Fit to the hadronic resolution (MC simulations)

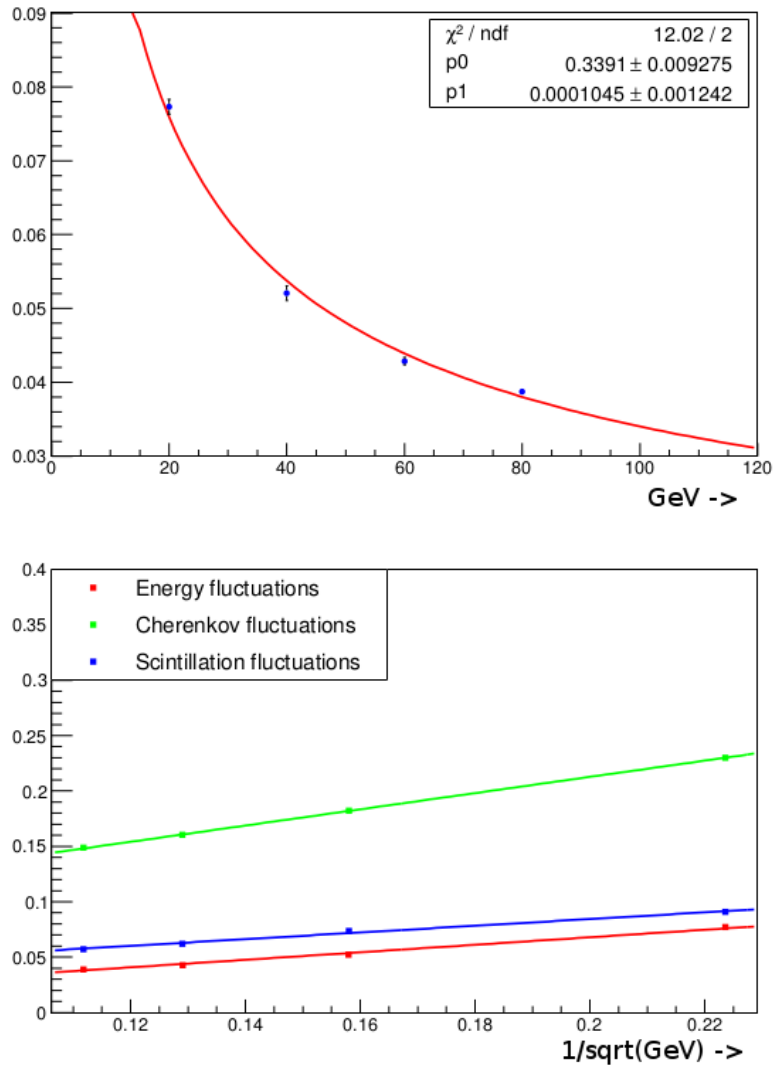

Figure 5.47: Monte Carlo simulations showing: (top) the relative hadronic resolution as reconstructed with the dual-readout formula; (bottom) the relative hadronic resolution independently for the *C* and *S* signals and for the dual-readout combination of the two.

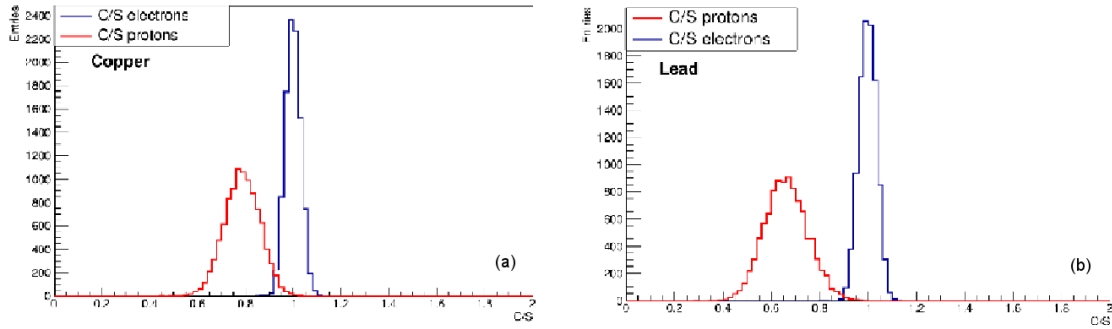

Figure 5.48: C/S ratio (MC simulations) for 80 GeV e^- and protons in (a) copper and (b) lead.

tion 5.8 when the containment is properly accounted for (i.e., the reconstructed energy corresponds, in average, to the beam energy times the average containment). The fact that the experimental resolution was, so far, about a factor of two worse than simulations, is in our understanding, largely due to the small lateral size of the prototypes. In order to fully validate the MC predictions, an R&D programme is being pursued.

The correlation of the invisible energy with all the other components of hadronic showers was also analysed. Preliminary results seem to indicate that the most appropriate variable to account for the fluctuations of the invisible energy component is, by far, the f_{em} , with correlation coefficients of 90%, 92%, 94%, for copper, iron and lead respectively. The kinetic energy of the neutrons is predicted to be, at best, correlated at the 76% level. If confirmed, this would prove that compensation through neutron signal pickup or amplification will anyway give worse results than the dual-readout method [34].

In terms of particle ID capabilities, in Figure 5.48 the C/S ratio is shown for 80 GeV e^- and protons in copper (left) and lead (right). For an electron efficiency of $\sim 98\%$, the rejection factor for protons is ~ 50 in copper and ~ 600 in lead. Of course, this is an ideal detector and in reality it is likely that the numbers will be worse. On the other hand, there are more variables that can be easily used in order to enhance the particle ID performance (namely the lateral shower profile, the starting time of the signal, the charge-to-amplitude ratio).

5.5.6.3 Projective geometry

Each tower, in the wedge geometry implementation, was exposed to 20 GeV electron beams, with an incident angle of $(1^\circ, 1.5^\circ)$, and the calibration constants calculated as the average deposit energy (in each tower) divided by the average C or S signal (of each tower). The response to an electron beam of the same energy is plotted in Figure 5.49. In the barrel region the response of all towers is within 0.2%, while in the forward the systematics are within 2%. All results were obtained with the quantum efficiency for the Čerenkov channel of each tower tuned to a light yield of ~ 30 pe/GeV , as estimated in the RD52 beam tests.

The performance of a few towers was studied with electron beams in the range of 10-100 GeV. Figure 5.50 shows the linearity and em energy resolutions for towers #0 and #45. In both cases, the combined S and C signal shows a resolution of $\sim 14\%/\sqrt{E}$ with a constant term of $\sim 0.1\%$ while the average response is constant within 0.4%.

The hadronic resolution was studied with pions in the same energy range. A χ value of 0.29, the value measured for the DREAM calorimeter [35], was used to reconstruct

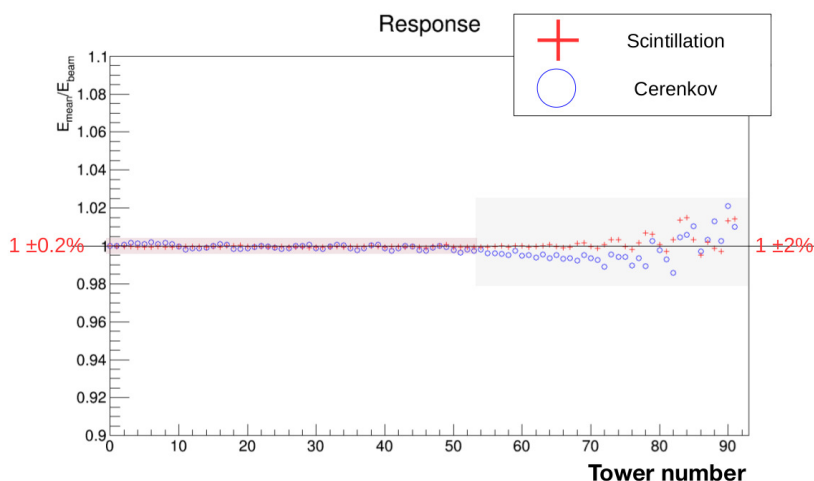

Figure 5.49: Ratio of reconstructed energy to the beam energy for 20 GeV e^- , as a function of the tower number, in the wedge geometry (MC simulations).

1 the shower energy with Eq. 5.8. In the linearity plots for both tower #0 and #45 in Fig-
 2 ure 5.51(a), the C and S responses to single pions increase non-linearly as the pion beam
 3 energy increases. On the other hand, the value reconstructed with the dual-readout for-
 4 mula shows a constant response to single pions $\sim 8\%$ lower than that to electrons (the
 5 reason being the shower containment). This effect in the GEANT4 simulations is de-
 6 scribed in reference [36]. In addition, the energy resolution after the correction (shown in
 7 Figure 5.51(b) for towers #0 and #45) is $\sim 26\%/\sqrt{E}$, with a constant term of less than
 8 1%. These results support the statement that the hadronic energy resolution and the re-
 9 sponse to single hadrons should be constant (and appropriate) over the full barrel region.
 10 We may reasonably expect to obtain good performance over the entire 4π detector.

11 For the wing geometry, the results, at present, are limited to the em performance of
 12 few towers and the results (linearity and em resolution) substantially reproduce the wedge
 13 geometry ones.

14 5.5.6.4 Short term planning and open issues

15 The performance for single hadrons, jets and τ leptons has to be understood and the work
 16 has just started. For validation, the comparison with a prototype with a non-marginal
 17 hadronic shower containment, like the RD52 lead matrix, will be pursued.

18 For the em simulations, a program for the comparison with the 2017 RD52 data is
 19 ongoing. Some initial understanding of the absolute photoelectron scale for the Čerenkov
 20 light should be available in a very short time.

21 In general, light attenuation effects need also to be considered, for a $\sim 2 - 2.5m$ long
 22 fiber detector, that may introduce a constant term in the hadronic resolution as a func-
 23 tion of the shower development point (late starting showers will give bigger and earlier
 24 signals).

25 The evaluation of advantages and disadvantages of filters (to dump the short attenuation-
 26 length components) and mirrors (to increase the number of photons that reach the pho-
 27 todetectors) may be relevant in this context.

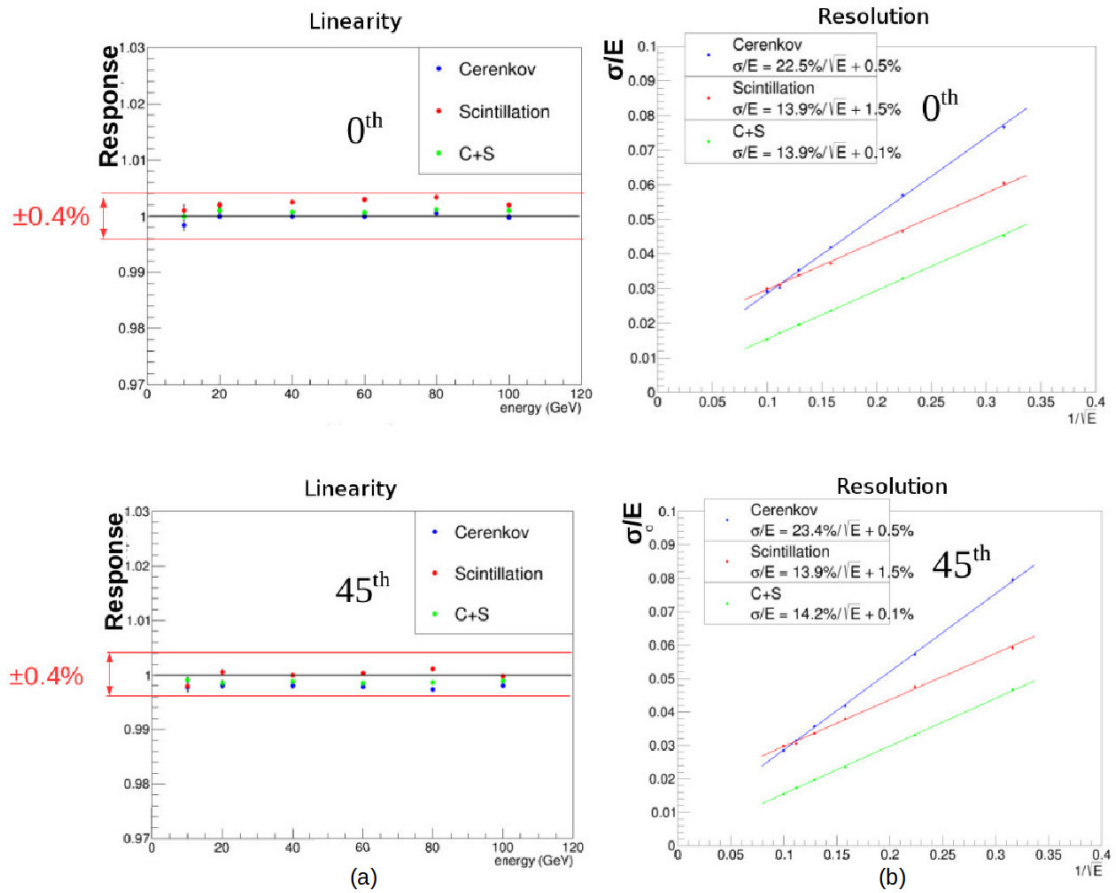

Figure 5.50: Linearity and em energy resolution for towers #0 (top) and #45 (bottom), in the wedge geometry (MC simulations).

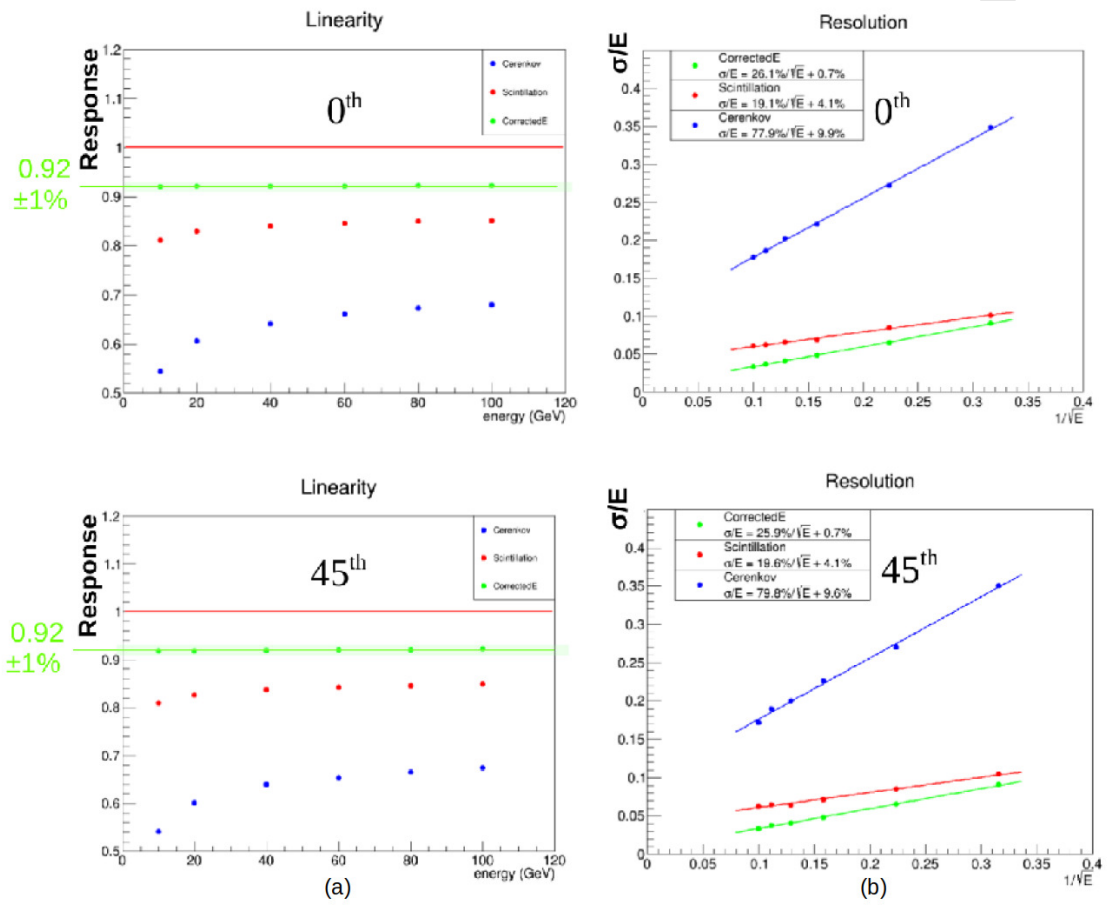

Figure 5.51: Linearity and energy resolution with pions, for towers #0 (top) and #45 (bottom), in the wedge geometry (MC simulations).

1 The effects of the integration of a preshower detector have to be evaluated and the
 2 e/π separation capability assessed and quantified, for both isolated particles and particles
 3 within jets.

4 **5.5.7 Final remarks**

5 The 15-year-long experimental research program on dual-readout calorimetry of the DREAM/RD52
 6 collaboration has yielded a technology that is mature for application at CEPC. The results
 7 show that the parallel, independent, readout of scintillation and Čerenkov light, makes it
 8 possible to cancel the effects of the fluctuations of the electromagnetic fraction in hadronic
 9 showers, dominating the energy resolution of most (if not all) the calorimeters built so
 10 far. In conjunction with high-resolution em and hadronic energy measurements, excellent
 11 standalone particle-ID capability has been demonstrated as well.

12 Those results give increasing support to the conviction that a matrix of alternating
 13 scintillating and clear fibers, inserted in copper or lead strips and readout by Silicon Pho-
 14 toMultipliers (SiPMs), will be able to provide performance more than adequate for the
 15 physics programs at the CEPC collider.

16 Nevertheless, there is a series of technical and physics issues that need to be solved,
 17 within the next 2-3 years in order to arrive up to the design of a realistic 4π detector. A
 18 non-exhaustive list must include:

- 19 1. The industrial machining of foils of copper, lead or some other material, with the
 20 required precision.
- 21 2. The development of a mechanical integration design.
- 22 3. The readout of the high granularity matrices of SiPM that, in order to be effective,
 23 will require the development of a dedicated Application Specific Integrated Circuit
 24 (ASIC). Possible aggregations of more fiber outputs into a single channel have also to
 25 be implemented and studied.
- 26 4. The need and, in case, the way for a longitudinally segmented calorimeter system
 27 and the performance of Particle Flow Algorithms to further boost the performance of
 28 dual-readout.
- 29 5. The development of a modular solution and the assessment, at all levels, of its perfor-
 30 mance, through beam tests of small modules and simulations. An intensive program
 31 of simulations is already ongoing for a dual-readout calorimeter system at CEPC. The
 32 response to single particles and jets is under study, in standalone configurations. The
 33 work for understanding the behavior of a 4π calorimeter integrated in a full detector,
 34 with a tracking and a magnetic system, has also started. This will include, as well, the
 35 evaluation of the combined performance with a preshower detector in front.

36 **References**

- 37 [1] J.-C. Brient, *Improving the jet reconstruction with the particle flow method: An*
 38 *introduction*, in *Calorimetry in Particle Physics*, pp. 445–451. World Scientific,
 39 2005.

- 1 [2] CALICE Wikipage.
2 <https://twiki.cern.ch/twiki/bin/view/CALICE/>.
- 3 [3] CALICE Collaboration, R. Cornat, *Semiconductor sensors for the CALICE SiW*
4 *EMC and study of the cross-talk between guard rings and pixels in the CALICE SiW*
5 *prototype*, in *Proceedings CALOR'08*, vol. 160, p. 012067. 2009.
- 6 [4] T. S. et al., *Performance study of SKIROC2/A ASIC for ILD Si-W ECAL*, in
7 *proceeding of the International Conference on Calorimetry for the High Energy*
8 *Frontier (CHEF 2017)*. 2017.
- 9 [5] D. Grondin, J. Giraud, and J.-Y. Hostachy, *CALICE Si/W ECAL: Endcap structures*
10 *and cooling system*, in *Proceedings, International Workshop on Future Linear*
11 *Colliders 2016 (LCWS2016): Morioka, Iwate, Japan, December 05-09, 2016*.
12 2017. [arXiv:1702.03770](https://arxiv.org/abs/1702.03770) [physics.ins-det].
13 [http://inspirehep.net/record/1513187/files/arXiv:](http://inspirehep.net/record/1513187/files/arXiv:1702.03770.pdf)
14 [1702.03770.pdf](http://inspirehep.net/record/1513187/files/arXiv:1702.03770.pdf).
- 15 [6] V. Boudry, *SiW ECAL R&D*, in *Fourth International Workshop on Future High*
16 *Energy Circular Colliders (CEPC2014)*. 2014.
17 [http://indico.ihep.ac.cn/event/4338/session/2/](http://indico.ihep.ac.cn/event/4338/session/2/contribution/35/material/slides/0.pdf)
18 [contribution/35/material/slides/0.pdf](http://indico.ihep.ac.cn/event/4338/session/2/contribution/35/material/slides/0.pdf).
- 19 [7] CALICE Collaboration, J. Repond et al., *Design and Electronics Commissioning of*
20 *the Physics Prototype of a Si-W Electromagnetic Calorimeter for the International*
21 *Linear Collider*, *JINST* **3** (2008) P08001, [arXiv:0805.4833](https://arxiv.org/abs/0805.4833)
22 [physics.ins-det].
- 23 [8] C. Adloff et al., *Response of the CALICE Si-W electromagnetic calorimeter physics*
24 *prototype to electrons*, *Nucl. Instrum. Meth.* **A608** (2009) 372–383.
- 25 [9] CALICE Collaboration, R. Poschl, *A large scale prototype for a SiW*
26 *electromagnetic calorimeter for a future linear collider*, in *Proceedings of*
27 *International Workshop on Future Linear Colliders (LCWS11) 26-30 Sep 2011.*
28 *Granada, Spain*. 2012. [arXiv:1203.0249](https://arxiv.org/abs/1203.0249) [physics.ins-det].
- 29 [10] V. Balagura et al., *SiW ECAL for future e^+e^- collider*, in *Proceedings, International*
30 *Conference on Instrumentation for Colliding Beam Physics (INSTR17):*
31 *Novosibirsk, Russia*. 2017. [arXiv:1705.10838](https://arxiv.org/abs/1705.10838) [physics.ins-det].
32 [http://inspirehep.net/record/1601898/files/arXiv:](http://inspirehep.net/record/1601898/files/arXiv:1705.10838.pdf)
33 [1705.10838.pdf](http://inspirehep.net/record/1601898/files/arXiv:1705.10838.pdf).
- 34 [11] A. Irlen, *Latest R&D news and beam test performance of the highly granular*
35 *SiW-ECAL technological prototype for the ILC*, *Journal of Instrumentation* **13**
36 (2018) no. 02, C02038.
- 37 [12] G. B. et al., *Conception and construction of a technological prototype of a*
38 *high-granularity digital hadronic calorimeter*, *JINST* **10** (2015) P10039.
- 39 [13] M. B. et al., *Performance of Glass Resistive Plate Chambers for a high granularity*
40 *semi-digital calorimeter*, *JINST* **6** (2011) P02001.

- 1 [14] CALICE Collaboration, *First results of the CALICE SDHCAL technological*
2 *prototype*, JINST **11** (2016) P04001.
- 3 [15] CALICE Collaboration, *Separation of nearby hadronic showers in the CALICE*
4 *SDHCAL prototype detector using ArborPFA*, CAN-054 (2016) .
- 5 [16] CALICE Collaboration, *Resistive Plate Chamber Digitization in a Hadronic*
6 *Shower Environment*, JINST **11** (2016) P06014.
- 7 [17] L. Caponetto *et al.*, *First test of a power-pulsed electronics system on a GRPC*
8 *detector in a 3-Tesla magnetic field*, JINST **7** (2012) P04009.
- 9 [18] F. Sefkow, *Prototype tests for a highly granular scintillator-based hadron*
10 *calorimeter*, CHEF2017. <https://indico.cern.ch/event/629521/contributions/2702990/>.
- 11
12 [19] The CALICE Collaboration, Y. Liu *et al.*, *A design of scintillator tiles read out by*
13 *surface-mounted SiPMs for a future hadron calorimeter*, (NSS/MIC), IEEE (2014)
14 1–4.
- 15 [20] The CALICE Collaboration, C. Adloff *et al.*, *hadronic energy resolution of a highly*
16 *granular scintillator-steel hadron calorimeter using software compensation*
17 *techniques*, Journal of Instrumentation **7(09)** (2012) 1–23.
- 18 [21] K. Krueger, *Software compensation and particle flow*, CHEF2017. <https://indico.cern.ch/event/629521/contributions/2703038/>.
- 19
20 [22] M. Bouchel *et al.*, *Second generation Front-end chip for H-Cal SiPM readout*
21 *:SPIROC*, ILC website. [https://agenda.linearcollider.org/](https://agenda.linearcollider.org/event/1354/contributions/2542/attachments/1826/3054/SPIROC_presentation_13_02_2007.pdf)
22 [event/1354/contributions/2542/attachments/1826/3054/](https://agenda.linearcollider.org/event/1354/contributions/2542/attachments/1826/3054/SPIROC_presentation_13_02_2007.pdf)
23 [SPIROC_presentation_13_02_2007.pdf](https://agenda.linearcollider.org/event/1354/contributions/2542/attachments/1826/3054/SPIROC_presentation_13_02_2007.pdf).
- 24 [23] R. Wigmans, *Calorimetry, Energy Measurement in Particle Physics*, vol. 168
25 (second edition). International Series of Monographs on Physics, Oxford University
26 Press, 2017.
- 27 [24] C. Patrignani and P. D. Group, *Review of Particle Physics*, Chinese Physics C **40**
28 (2016) no. 10, 100001.
29 <http://stacks.iop.org/1674-1137/40/i=10/a=100001>.
- 30 [25] D. E. Groom, *Energy flow in a hadronic cascade: Application to hadron*
31 *calorimetry*, Nucl. Instrum. Methods A **572** (2007) 633–653.
- 32 [26] D. E. Groom, *Erratum to "Energy flow in a hadronic cascade: Application to*
33 *hadron calorimetry" [Nucl. Instr. and Meth. A 572 (2007) 633-653]*, Nucl. Instrum.
34 *Methods A* **593** (2008) 638.
- 35 [27] N. Akchurin *et al.*, *Particle identification in the longitudinally unsegmented RD52*
36 *calorimeter*, Nucl. Instrum. Methods A **735** (2014) 120.
- 37 [28] N. Akchurin *et al.*, *The electromagnetic performance of the RD52 fiber calorimeter*,
38 Nucl. Instrum. Methods A **735** (2014) 130.

- 1 [29] N. Akchurin et al., *Lessons from Monte Carlo simulations of the performance of a*
2 *dual-readout fiber calorimeter*, *Nucl. Instrum. Methods A* **762** (2014) 100.
- 3 [30] A. Cardini et al., *The small-angle performance of a dual-readout fiber calorimeter*,
4 *Nucl. Instrum. Methods A* **808** (2016) 41.
- 5 [31] R. Wigmans, *New results from the RD52 project*, *Nucl. Instrum. Methods A* **824**
6 (2016) 721.
- 7 [32] S. Lee et al., *Hadron detection with a dual-readout fiber calorimeter*, *Nucl.*
8 *Instrum. Methods A* **866** (2017) 76.
- 9 [33] 4th Detector Collaboration Letter of Intent: <http://www.4thconcept.org/4LoI.pdf>.
- 10 [34] S. Lee, M. Livan, and R. Wigmans, *On the limits of the hadronic energy resolution*
11 *of calorimeters*, *Nucl. Instrum. Methods A* **882** (2018) 148.
- 12 [35] N. Akchurin et al., *Hadron and jet detection with a dual-readout calorimeter*, *Nucl.*
13 *Instrum. Methods A* **537** (2005) 537.
- 14 [36] N. Akchurin et al., *Lessons from Monte Carlo simulations of the performance of a*
15 *dual-readout fiber calorimeter*, *Nucl. Instrum. Methods A* **762** (2014) 100.

Draft-V1.0

CHAPTER 6

DETECTOR MAGNET SYSTEM

1 The CEPC detector magnet is an iron-yoke-based solenoid to provide an axial magnetic
2 field of 3 Tesla. A room temperature bore is required with a diameter of 6.8 m. This chap-
3 ter describes the conceptual design of magnet, including the design of field distribution,
4 solenoid coil, cryogenics, quench protection, power supply and the yoke. In the end of this
5 chapter, the R&D Section 6.5 brings up other concept options and some reach projects.
6 Compensation magnets are discussed in the Accelerator CDR Chapter 9.2.

7 6.1 Magnetic field design

8 6.1.1 Main parameters

9 The CEPC detector magnet follows the same design concepts of the CMS and ILD detec-
10 tor magnets [1, 2]. The magnet system consists of the superconducting coil and the iron
11 yoke with a barrel yoke and two end-cap yokes. The superconducting coil is designed
12 with 5 modules wound with 4 layers. The three middle coil modules and the two end coil
13 modules are wound with 78 and 44 turns, respectively. The operating current is 15,779
14 A for each turn corresponding to 3 T at the interaction point. The geometrical layout of
15 magnet are shown in Figure 6.1. The main magnetic and geometrical design parameters
16 are given in Table 6.1.

17 6.1.2 Magnetic field design

18 The magnetic field simulation has been calculated in 2D FEA model, with fine structure
19 of the barrel yokes and end-cap yokes. Figure 6.2 shows the magnetic field contour of the

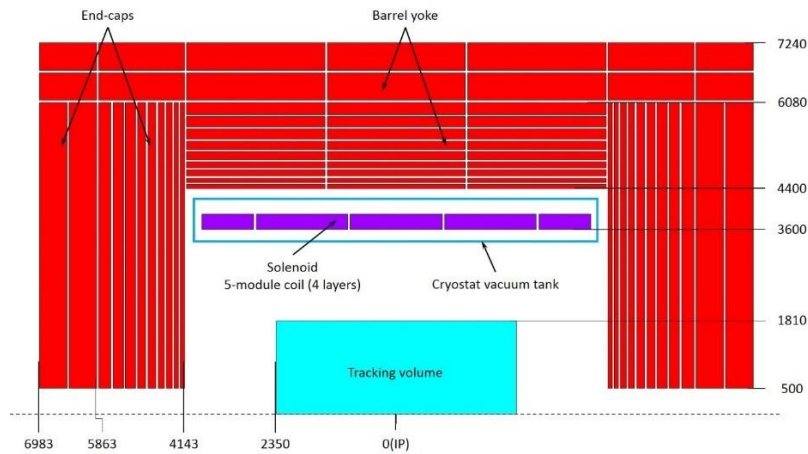

Figure 6.1: 2D geometrical layout of CEPC detector magnet. The magnet system consists of the superconducting coil and the iron yoke with a barrel yoke and two end-cap yokes. The superconducting coil is designed with 5 modules wound with 4 layers.

The solenoid central field (T)	3	Working current (A)	15779
Maximum field on conductor (T)	3.485	Total ampere-turns of the solenoid (MA _t)	20.323
Coil inner radius (mm)	3600	Inductance (H)	10.46
Coil outer radius (mm)	3900	Stored energy (GJ)	1.3
Coil length (mm)	7600	Cable length (km)	30.35

Table 6.1: Main parameters of the solenoid coil

- 1 magnet. The maximum field on NbTi cable is 3.5 Tesla. The edge of 50 Gauss stray field
- 2 is at 13.6 m from the beam axis and axial direction 15.8 m from the IP.

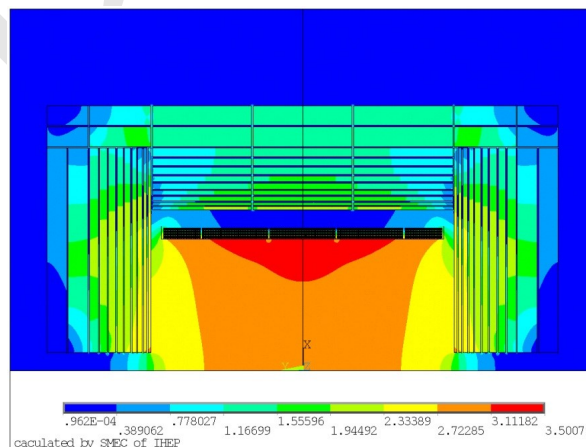

Figure 6.2: Field map of magnet in 2D FEA model. The magnetic field at IP is 3.0 T, The maximum field on superconducting cable is 3.5 T.

6.2 Solenoid coil

The conceptual superconducting conductor is based on the self-supporting conductor design of CMS detector magnet, composed of NbTi Rutherford cable, the pure aluminum stabilizer and aluminum alloy reinforcement.

The coil windings is wound by inner winding technique with the support aluminum-alloy cylinder, which acts as an external supporting mandrel and taking away the heat energy induced by quench. In order to maintain the operating temperature of LTS detector magnet, the cooling tubes for circular flow of LHe are welded on the outer surface of the aluminum-alloy cylinder.

6.3 Ancillaries (cryogenics, power supply, quench protection)

6.3.1 Cryogenics system

The coil cryogenic system is based on the CMS cryogenic system. The magnetic stored energy is 1.3 GJ. The thermosiphon principle is used for the coil indirect cooling mode using saturated liquid helium. A horizontal cryostat is designed, including a vacuum tank, an inner thermal shield, an outer thermal shield. The stainless steel vacuum vessel is 8.05 m length cylinder with diameter of 8.5 m. Two service towers are designed on the top of the cryostat in the central ring of the barrel yoke.

6.3.2 Power supply

A low ripple DC current-stabilized power supply, with low output voltage and high output current, is requested for CEPC detector magnet. The power supply is expected to have a free-wheel diode system and to be cooled with demineralized water. The main circuit of a standard power supply includes 12 pulse diode rectifiers and 4 IGBT chopper units with a switching frequency of 10 kHz.

6.3.3 Quench protection and instrumentation

Selected voltage signals from the CEPC detector magnet coil and current leads are monitored by an FPGA board for quench detection. If a quench happened, the power supply is switched off and a dump resistor is switched into the electrical circuit, the huge stored energy will be extracted mainly by the dump resistor and partially by the coil itself.

6.4 Iron yoke design

The iron yoke is designed not only for field quality but also for resisting magnetic forces, as well as the mechanical support of the sub-detectors. Therefore high permeability material with high mechanical strength is required for the yoke material in account of mechanical performance and magnetic field. The yoke also provides room for the muon detector, which will sit between layers of the yoke, and allows space for data cables, cooling pipes, gas pipes and etc. through the yoke. The yoke is divided into two main components, one cylindrical barrel yoke and two end-cap yokes. The total weight of the yoke assembly is about 10,000 tons. According to the experience of detector stray field and the mechanical requirement, we are studying on the yoke weight reducing.

1 The barrel yoke is a dodecagonal shape structure with a length of 8,206 mm (Figure
 2 6.3). The outer diameter of the dodecagon and the inner diameter are 14,480 mm and
 3 8,800 mm. The barrel yoke is subdivided along the beam axis into 3 rings, with 11 layers
 4 in each ring. Each ring of the barrel yoke is composed of 12 segments. 40 mm gap is
 5 designed between the rings and the layers for placing the muon detector and the electronics
 6 cables and services. From the inner to the outer, the layer thicknesses are 80 mm, 80 mm,
 7 120 mm, 120 mm, 160 mm, 160 mm, 200 mm, 200 mm, 240 mm, 540 mm, 540 mm,
 8 respectively.

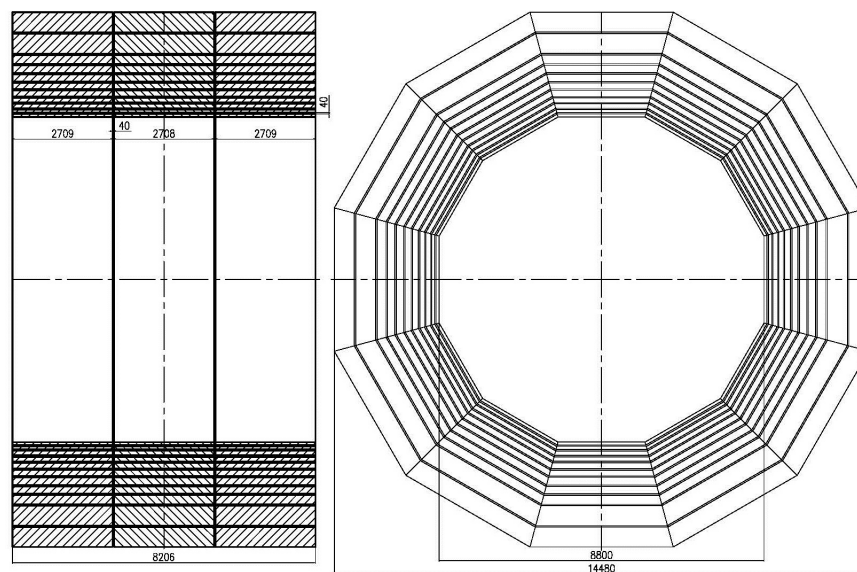

Figure 6.3: The barrel yoke of CEPC detector magnet. The barrel yoke is a dodecagonal shape structure with a length of 8,206 mm. The outer diameter of the dodecagon and the inner diameter are 14,480 mm and 8,800 mm. The barrel yoke is subdivided along the beam axis into 3 rings, with 11 layers in each ring. Each ring of the barrel yoke is composed of 12 segments. 40 mm gap is designed between the rings and the layers for placing the muon detector and the electronics cables and services. From the inner to the outer, the layer thicknesses are 80 mm, 80 mm, 120 mm, 120 mm, 160 mm, 160 mm, 200 mm, 200 mm, 240 mm, 540 mm, 540 mm, respectively.

9 The end-cap yokes are designed to dodecagonal structure with the out diameter of
 10 14,480 mm. Each end-cap yoke will consist of 11 layers (Figure 6.4). Each end-cap yoke
 11 is composed of 12 segments. The layer thicknesses are 80 mm, 80 mm, 120 mm, 120 mm,
 12 160 mm, 160 mm, 200 mm, 200 mm, 240 mm, 540 mm, 540 mm, respectively.

13 6.5 Alternative designs and R&D

14 6.5.1 LTS solenoid for the IDEA detector

15 A "thin" 6 m long solenoid with an inner bore of 2.1 m radius and a field of 2 Tesla
 16 is a key element of the IDEA detector, where the calorimeter is located outside of the
 17 solenoid, allowing the maximum possible volume for tracking, but requiring maximum
 18 transparency. By "thin" we mean that the magnet should give minimal perturbation to the
 19 calorimetric measurements. The current design is mostly derived by scaling the present
 20 2 Tesla solenoid of the ATLAS detector and uses a self-supporting aluminum stabilized
 21 NbTi conductor. Preliminary engineering studies [3, 4] indicate that the coil and the cryo-

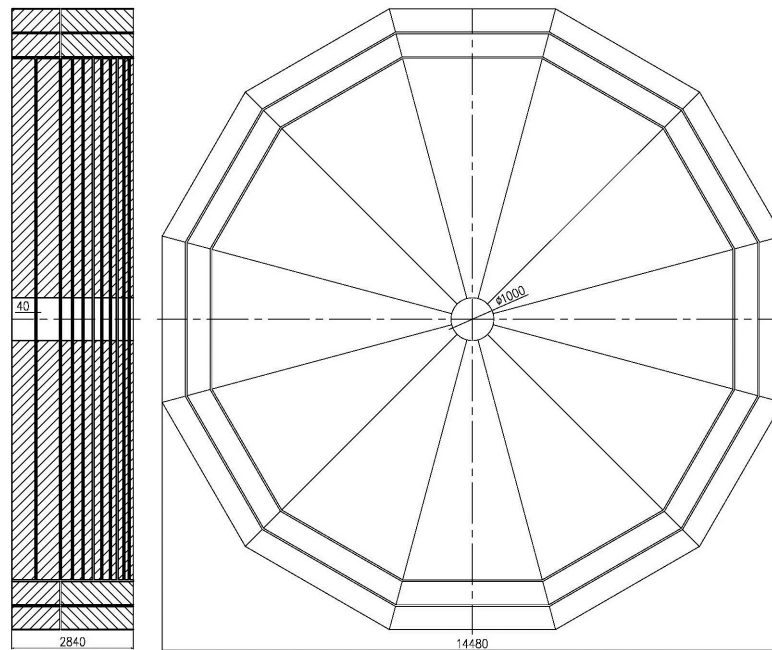

Figure 6.4: The end-cap yokes of CEPC detector magnet. The end-cap yokes are designed to dodecagonal structure with the out diameter of 14,480 mm. Each end-cap yoke will consist of 11 layers (Fig. 6.4). Each end-cap yoke is composed of 12 segments. The layer thicknesses are 80 mm, 80 mm, 120 mm, 120 mm, 160 mm, 160 mm, 200 mm, 200 mm, 240 mm, 540 mm, 540 mm, respectively.

1 stat can fit in a total thickness of 30 cm using current technology; for 0.46 radiation lengths
 2 of the coil and 0.28 radiation lengths of the cryostat or 0.16 interaction lengths at normal
 3 incidence. Up to 20% additional reduction in the overall thickness may be achieved with
 4 more R&D and engineering.

5 6.5.2 HTS solenoid for IDEA detector

6 A large HTS solenoid is being studied for the IDEA detector. The HTS solenoid is sup-
 7 posed to use YBCO stacked-tape cable as the conductor. The radiation length of single
 8 YBCO tape coated with 10 μm copper is about 0.004 X_0 . Each tape carries 700 A at 20
 9 K. 35 YBCO tapes stacked together allows 24.5 kA. These tapes are embedded in 5 mm
 10 pure aluminium. The radiation length of this YBCO stacked-tape cable is estimated to be
 11 0.2 X_0 . The radiation length of HTS coil will be less than half of the current LTS coil de-
 12 sign. If the operation temperature of the cold mass is raised to 20 K, the heat conductivity
 13 parameters of all components are improved. In addition, the electricity consumption of
 14 cooling station is much lower than that at 4.2 K. Therefore, the YBCO stacked-tape cable
 15 and the cryogenics are brought into R&D.

16 6.5.3 Dual solenoid design

17 The dual solenoid design is presented for a conceptual option for CEPC detector magnet,
 18 which contains two series connected superconducting solenoids carrying the opposite di-
 19 rection current, based on FCC twin solenoid [5]. The main solenoid provides central field
 20 within the room temperature bore. The outer solenoid provides the stray field shielding
 21 and a magnetic field between the two solenoids to facilitate muon tracking. The main ad-

1 vantage of this dual solenoid is that the system becomes comparatively light-weight and
 2 cost saving without iron yoke. The sketch is shown in Figure 6.5.

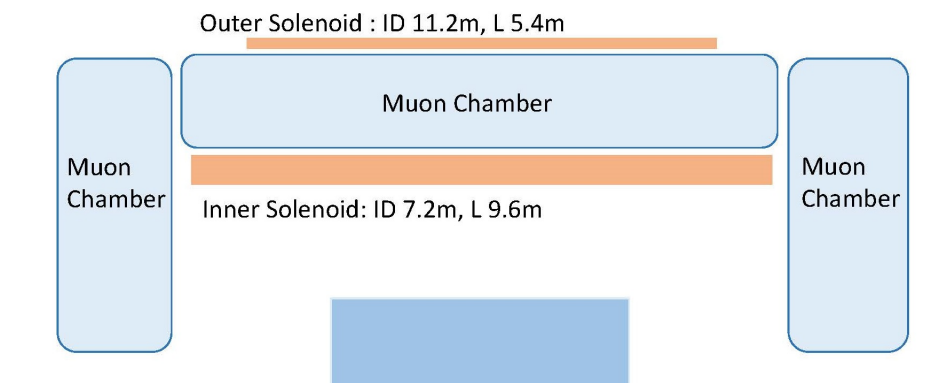

Figure 6.5: The sketch of dual solenoid design. The main solenoid provides central field within the room temperature bore. The outer solenoid provides the stray field shielding and a magnetic field between the two solenoids to facilitate muon tracking. The inner diameter of the main solenoid is 7.2 m. The inner diameter of the outer solenoid is 11.2 m.

3 6.5.4 Superconducting conductor

4 The coil is simulated with an elasto-plastic 2D FE model. Mechanical analysis requires
 5 the experimental material properties of all conductor components. We have developed a
 6 10 m long NbTi Rutherford cable embedded inside stabilizer which provides I_c 5 kA at
 7 4 T background magnetic field. Meanwhile we measured the material properties and the
 8 tensile stress of 10 m cable. Longer conductor with higher I_c 15 kA at 4 T background is
 9 ongoing.

10 6.5.5 Thermosyphon circuit

11 Thermosyphon principle is used to cool CEPC detector superconducting magnet by the
 12 U-shaped circuit configuration carrying LHe on the outer surfaces of the coil supporting
 13 cylinders. The thermosyphon circuit consists of helium phase separator located in an el-
 14 evated position and the cooling tubes. In order to study the phase transition process of
 15 helium in the circuit, the changes of the temperature distribution and the density distri-
 16 bution over the time, a 1:10 scale thermosyphon circuit will be established for simulation
 17 and experiment.

18 References

- 19 [1] T. Behnke, J. E. Brau, P. N. Burrows, J. Fuster, M. Peskin, M. Stanitzki, Y. Sugimoto,
 20 S. Yamada, and H. Yamamoto, *The International Linear Collider Technical Design
 21 Report*, vol. Detector. 2013.
- 22 [2] C. Collaboration, *The CMS magnet project: Technical Design Report*, CERN/LHCC,
 23 1997.

- 1 [3] M. Caccia, *An International Detector for Electron-Positron Accelerator(IDEA)*,
2 Workshop on Circular Electron-Positron Colliders. Roma, May 24-26th, 2018.
- 3 [4] H. ten Kate, *Ultra-light 2T/4m bore Detector Solenoid for FCCee*, FCC Annual
4 meeting. Amsterdam, April 9-14th, 2018.
- 5 [5] M. Mentink, A. Dudarev, H. F. P. Da Silva, C. P. Berriaud, G. Rolando, R. Pots,
6 B. Cure, A. Gaddi, V. Klyukhin, H. Gerwig, et al., *Design of a 56-GJ Twin solenoid
7 and dipoles detector magnet system for the future circular collider*, IEEE
8 Transactions on Applied Superconductivity **26** (2016) no. 3, 1–6.

Draft-V1.0

Draft-V1.0

CHAPTER 7

MUON SYSTEM

1 The muon system for a CEPC detector is designed to identify and measure muons, and will
2 be located within the solenoid flux return yoke of the whole spectrometer. Two detector
3 concepts are envisaged for the CEPC collider and they will likely employ different muon
4 systems. A common requirement for the muon detectors will be to identify muons with
5 very high efficiency ($\geq 95\%$) and high purity, over the largest possible solid angle and
6 down to low p_T values (≥ 3 GeV/c). A standalone muon momentum resolution from
7 the muon detector could be required, translating in a good position resolution along the
8 muon track which would add robustness and redundancy to the whole detector design.
9 In particular the muon system will significantly help in identifying muon produced within
10 jets, for example from b decays.

11 The muon system plays an important role in measuring physics processes involving
12 muon final states, e.g. $e^+e^- \rightarrow ZH$ with $Z \rightarrow e^+e^-$ or $\mu^+\mu^-$ and also for studying long-
13 lived particles that would decay far from the primary vertex but still within the detector.
14 In addition, the muon system compensates for leaking energetic showers and late show-
15 ering pions from the calorimeters, which could help to improve the relative jet energy
16 resolution[1].

17 In this chapter the baseline muon system design is described and then two possi-
18 ble technologies for realising the muon detector are presented, specifically the Resistive
19 Plate Chamber (RPC) and an innovative type of Micro Pattern Gas detector (MPGD), the
20 μ -RWELL detector. The main difference between the two technologies lies in the posi-
21 tion resolution and the cost. More layers of RPC detectors are needed to achieve a good
22 momentum resolution on the muon tracks with respect to the μ -RWELL case, where 3-4
23 layers would be sufficient. In terms of rate capability both technologies are more than
24 adequate for the CEPC environment. If the requirement of a standalone muon momentum

1 resolution from the muon detector is relaxed, the number of layers of the RPC solution
 2 could be greatly reduced. Other gas detectors are also being considered as possible op-
 3 tions, such as Gas Electron Multiplier (GEM), MicroMegas and Monitored Drift Tubes
 4 (MDT), although they are not described here.

5 7.1 Baseline Design

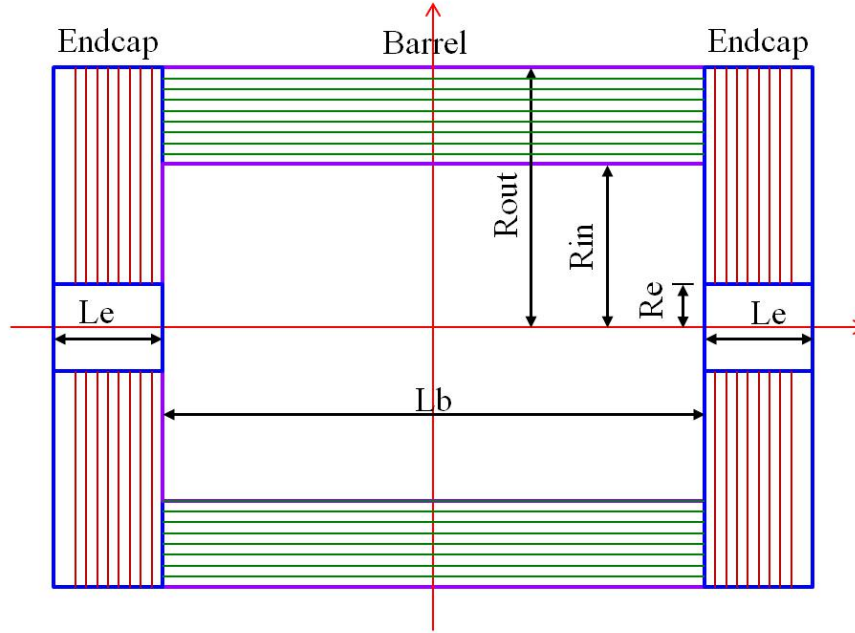

Figure 7.1: The basic layout of the muon system, subdivided in a barrel closed by two endcaps. L_b is the length of the barrel and L_e is the length of each endcap. R_{out} (R_{in}) is the outer (inner) radius of the barrel. R_e is the inner radius of each endcap.

6 The CEPC muon system is the outermost component of the whole detector. It is
 7 divided into barrel and end-caps, as shown in Figure 7.1. Both the barrel and end-caps
 8 consist of segmented modules. The segmentation is constrained by the maximum sizes
 9 of the module and sensitive unit (more segments are required for a larger detector), do-
 10 decagon segmentation is selected for the baseline design of the CEPC muon system. All
 11 baseline design parameters are summarised in Table 7.1. These parameters will be further
 12 optimised together with the inner detectors, in particular the ECAL and the HCAL.

13 The number of sensitive layers and the thickness of iron (or tungsten) in the absorbers
 14 are two critical parameters. For the baseline design, the total thickness of iron
 15 absorber is chosen to be 8λ (the nuclear interaction length of iron) distributed in 8 layers,
 16 which should be sufficient for effective muon tracking together in combination with the
 17 calorimeters. Gaps of 4 cm between neighbouring iron layers give adequate space for
 18 installing sensitive detectors.

19 The solid angle coverage of the CEPC muon system should be up to $0.98 \times 4\pi$ in
 20 accordance with the tracking system. Minimum position resolutions of $\sigma_{r\phi} = 2.0$ cm and
 21 $\sigma_z = 1.5$ cm are required. Since the particle flow algorithm calorimetry provides very
 22 good particle identification capabilities, the detection efficiency of 95% ($E_\mu > 5$ GeV)

Parameter	Possible range	Baseline
Lb/2 [m]	3.6 – 5.6	4.0
Rin [m]	3.5 – 5.0	4.4
Rout [m]	5.5 – 7.2	7.0
Le [m]	2.0 – 3.0	2.6
Re [m]	0.6 – 1.0	0.8
Segmentation	8/10/12	12
Number of layers	3 – 10	8
Total thickness of iron	6 – 10 λ ($\lambda = 16.77$ cm)	8 λ (136 cm) (8/8/12/12/16/16/20/20/24) cm
Solid angle coverage	(0.94 – 0.98) $\times 4\pi$	0.98
Position resolution [cm]	$\sigma_{r\phi}$: 1.5 – 2.5	2
	σ_z : 1 – 2	1.5
Time resolution [ns]	< 10	1 – 2
Detection efficiency ($E_\mu > 5$ GeV)	92% – 99%	95%
Fake($\pi \rightarrow \mu$)@30GeV	0.5% – 3%	< 1%
Rate capability [Hz/cm ²]	50 – 100	~60
Technology	RPC	RPC (super module, 1 layer readout, 2 layers of RPC)
	μ RWell	
Total area [m ²]	Barrel	~4450
	Endcap	~4150
	Total	~8600

Table 7.1: The design parameters of the baseline CEPC muon system.

of the CEPC muon system should provide enough redundancy and complement in muon detection for most physics processes related to muons. The muon system should provide several hits each with a spatial resolution of a few cm, a time resolution of a few ns and a rate capability of 50 – 100 Hz/cm². Based on the dimensions and segmentation of the baseline design, the total sensitive area of the muon system amounts to 8600 m².

7.2 The Resistive Plate Chamber technology

Resistive Plate Chamber (RPC) is suitable for building large area detectors with centimeter spatial resolution. It has been applied in muon systems for experiments including BaBar [2], Belle [3], CMS [4], ATLAS [5], BESIII [6], and Daya Bay [7]. It provides a common solution with the following advantages: low cost, robustness, easy construction of large areas, large signal, simple front-end electronics, good time and spatial resolution. It is chosen as the baseline design of the CEPC muon system.

RPCs can be built with glass or Bakelite, and run in avalanche or streamer mode. Bakelite RPCs of about 1200 m² and 3200 m² were produced for the BESIII and Daya Bay muon systems, respectively. Compared with glass RPC, Bakelite RPC has the advantages of easier construction, lower density, larger cell size and lower cost, especially if the event rate is below 100 Hz/cm² as required by the CEPC muon system. The characteristics of Bakelite and glass RPCs are compared in Table 7.2. Further improvements are required for Bakelite RPCs, however, in terms of long-term stability, detection efficiency, readout technologies, lower resistivity (< 10¹⁰) and higher rate capability.

Parameters	Bakelite	Glass	
Bulk resistivity [$\Omega \cdot \text{cm}$]	Normal	$10^{10} \sim 10^{12}$	
	Developing	$10^8 \sim 10^9$	
Max unit size (2 mm thick) [m]	1.2×2.4	1.0×1.2	
Surface flatness [nm]	< 500	< 100	
Density [g/cm^3]	1.36	2.4~2.8	
Min board thickness [mm]	1.0	0.2	
Mechanical performance	Tough	Fragile	
Rate capability [Hz/cm^2]	Streamer	100@92%	
	Avalanche	10K	100@95%
Noise rate [Hz/cm^2]	Streamer	< 0.8	0.05

Table 7.2: Comparison of the main parameters of Bakelite and glass RPCs.

7.3 The μ -RWELL technology

The μ -RWELL is a compact, spark-protected and single amplification stage Micro-Pattern Gas Detector (MPGD). A μ -RWELL detector [8] is composed of two PCBs: a standard GEM Drift PCB acting as the cathode and a μ -RWELL PCB that couples in a unique structure the electron amplification (a WELL patterned matrix) and the readout stages.

1 The layout is shown in Figure 7.2a). A standard GEM 50 μm polyimide foil is copper
 2 clad on one side and Diamond Like Carbon (DLC) sputtered on the opposite side. The
 3 thickness of the DLC layer is adjusted according to the desired surface resistivity value
 4 (50-200 $\text{M}\Omega/\square$) and represents the bottom of the WELL matrix providing discharge sup-
 5 pression as well as current evacuation. The foil is then coupled to a readout board.(as
 6 shown in Figure 7.2b)). A chemical etching process is then performed on the top surface
 7 of the overall structure in order to create the WELL pattern (conical channels 70 μm (50
 8 μm) top (bottom) in diameter and 140 μm pitch) that constitutes the amplification stage.
 9 The process is shown in Figure 7.3. The high voltage applied between the copper and the
 10 resistive DLC layers produces the required electric field within the WELLS that is neces-
 11 sary to develop charge amplification. The signal is capacitively collected at the readout
 12 strips/pads. Two main schemes for the resistive layer can be envisaged: a *low-rate* scheme
 13 (for particles fluxes lower than 100 kHz/cm^2) based on a simple resistive layer of suit-
 14 able resistivity; and an *high-rate* scheme (for a particle flux up to 1 MHz/cm^2) based on
 15 two resistive layers intra-connected by vias and connected to ground through the readout
 16 electrodes. Finally, a drift thickness of 3-4 mm allows for reaching a full efficiency while
 17 maintaining a versatile detector compactness.

18 A distinctive advantage of the proposed μ -RWELL technology is that the detector
 19 does not require complex and time-consuming assembly procedures (neither stretching
 20 nor gluing), and is definitely much simpler than many other existing MPGDs, such as
 21 GEMs or MicroMegas. Being composed of only two main components, the cathode and
 22 anode PCBs, is extremely simple to be assembled. This makes the cost of a μ -RWELL
 23 detector typically less than half the cost of a triple-GEM detector of the same size and the
 24 same strip pitch.

25 The μ -RWELL technology, especially in its *low-rate* version, is a mature solution,
 26 with whom single detectors of a 0.5 m^2 have been realised and successfully operated in the
 27 laboratory as well as in test beams. They can withstand particle rates up to a few tens of
 28 kHz/cm^2 , providing a position resolution as good as $\sim 60 \mu\text{m}$ with a time resolution of 5-6
 29 ns. The detailed results are presented in the Appendix. The requirements of a muon detec-
 30 tor for CEPC are not as stringent and therefore can be easily and cost-effectively achieved
 31 with the μ -RWELL technology. Moreover the μ -RWELL technology is a robust solution,
 32 intrinsically safer against sparks than, for example, the widely used GEM detectors. The
 33 muon system could be realised by using tiles of μ -RWELL detectors of a size 50x50 cm^2 .
 34 This would make the whole muon detector very modular with components bought directly
 35 from industry. A CEPC muon detector made of μ -RWELL tiles could consist of three or
 36 four detector layers stations, each equipped with a couple of layers of μ -RWELL detectors
 37 in order to provide a very precise, of the order of 200-300 μm , position resolution on the
 38 coordinates of a muon track.

39 7.4 Future R&D

40 The baseline conceptual design and most promising technologies for the CEPC muon sys-
 41 tem have been discussed. Future R&D requires detailed studies of different technologies
 42 and further optimization of baseline design parameters. Several critical R&D items have
 43 been identified, including:

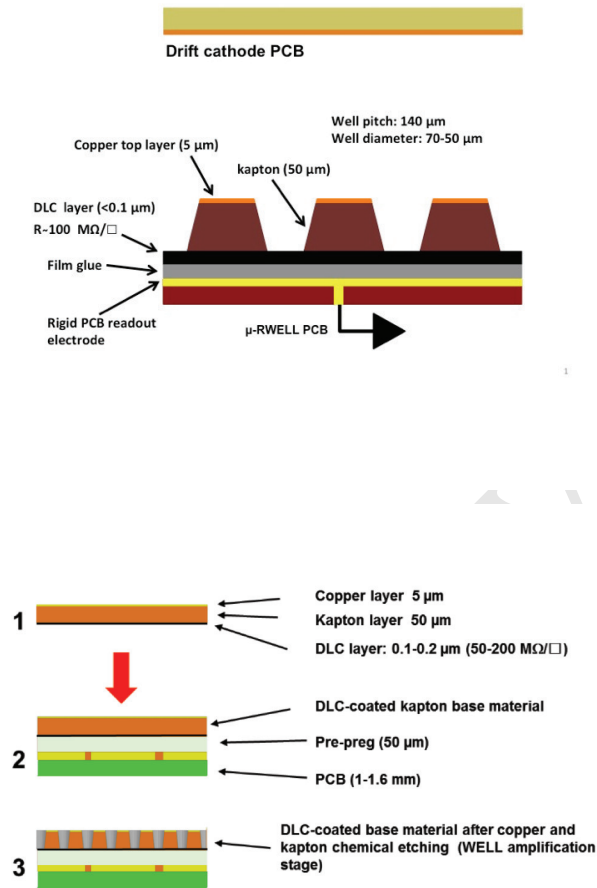

Figure 7.2: a) Layout of a μ -RWELL detector module with the cathode and the μ -RWELL PCBs; b) Coupling steps of the μ -RWELL PCB.

- 1 ▪ **Long-lived particles optimization:** Explore new physics scenario of long-lived particles and exotic decays. Optimize detector parameters and technologies.
- 2
- 3 ▪ **Layout and geometry optimization:** Detailed studies on the structure of the segments and modules need to be carried out to minimise the dead area and to optimise the interface for routing, support and assembly. The geometry and dimensions need to be optimized together with the inner detectors, in particular the ECAL and the HCAL.
- 4
- 5
- 6
- 7 ▪ **Detector optimization:** Study aging effects, improve long-term reliability and stability, readout technologies.
- 8
- 9 ▪ **Detector industrialization:** Improve massive and large area production procedures for all technologies. One example is the engineering and the following industrialization of the μ -RWELL technology. The engineering of the detector essentially coin-
- 10
- 11

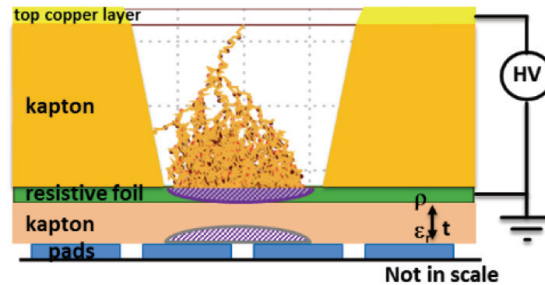

Figure 7.3: Amplification stage of a μ -RWELL detector directly coupled to the readout PCB.

1 cides with the technological transfer of the manufacturing process of the anode PCB
 2 and the etching of the kapton foil to suitable industrial partners.

3 References

- 4 [1] CALICE Collaboration, *Construction and performance of a silicon*
 5 *photomultiplier/extruded scintillator tail-catcher and muon-tracker*, JINST **7** (2012)
 6 no. 04, P04015, [arXiv:1201.1653](https://arxiv.org/abs/1201.1653).
 7 <http://stacks.iop.org/1748-0221/7/i=04/a=P04015>.
- 8 [2] Babar Collaboration, *The BaBar detector*, Nucl. Instrum. Meth. **A479** (2002) 1–116,
 9 [arXiv:hep-ex/0105044](https://arxiv.org/abs/hep-ex/0105044).
- 10 [3] A. Abashian et al., *The Belle Detector*, Nucl. Instrum. Meth. **A479** (2002) 117–232.
 11 KEK-PROGRESS-REPORT-2000-4.
- 12 [4] CMS Collaboration, *The CMS muon project: Technical Design Report*. Technical
 13 Design Report CMS. CERN, Geneva, 1997.
 14 <http://cds.cern.ch/record/343814>.
- 15 [5] ATLAS Collaboration, *ATLAS muon spectrometer: Technical Design Report*.
 16 Technical Design Report ATLAS. CERN, Geneva, 1997.
 17 <http://cds.cern.ch/record/331068>.
- 18 [6] Y.-G. XIE, J.-W. ZHANG, Q. LIU, J.-F. HAN, S. QIAN, N. YAO, J.-B. ZHAO,
 19 J. CHEN, and J.-C. LI, *Performance Study of RPC Prototypes for the BESIII Muon*
 20 *Detector*, Chinese Physics C **31** (2007) no. 01, 70–75.
 21 [http://cpc-hepnp.ihep.ac.cn:](http://cpc-hepnp.ihep.ac.cn:8080/Jwk_cpc/EN/abstract/abstract7618.shtml)
 22 [8080/Jwk_cpc/EN/abstract/abstract7618.shtml](http://cpc-hepnp.ihep.ac.cn:8080/Jwk_cpc/EN/abstract/abstract7618.shtml).

- 1 [7] J.-L. Xu, M.-Y. Guan, C.-G. Yang, Y.-F. Wang, J.-W. Zhang, C.-G. Lu,
2 K. McDonald, R. Hackenburg, K. Lau, L. Lebanowski, C. Newsom, S.-K. Lin,
3 J. Link, L.-H. Ma, and P. Viktor, *Design and preliminary test results of Daya Bay*
4 *RPC modules*, Chinese Physics C **35** (2011) no. 9, 844.
5 <http://stacks.iop.org/1674-1137/35/i=9/a=011>.
- 6 [8] G. Bencivenni, R. D. Oliveira, G. Morello, and M. P. Lener, *The micro-Resistive*
7 *WELL detector: a compact spark-protected single amplification-stage MPGD*,
8 *Journal of Instrumentation* **10** (2015) no. 02, P02008.
9 <http://stacks.iop.org/1748-0221/10/i=02/a=P02008>.

Draft-V1.0

CHAPTER 8

READOUT ELECTRONICS, TRIGGER AND DATA ACQUISITION

1 The readout electronics and data acquisition (DAQ) systems for the detectors at the CEPC
2 need to operate synchronously with the circular collider time structure for beam collisions
3 and deliver high efficiency for recording all events without compromising on rare or yet
4 unknown physics processes. The beam conditions and time structure are adjusted to op-
5 erate in three different modes, corresponding to three different center-of-mass energies
6 (\sqrt{s}): Higgs factory ($e^+e^- \rightarrow ZH$) at $\sqrt{s} = 240$ GeV, Z boson factory ($e^+e^- \rightarrow Z$) at
7 $\sqrt{s} = 91.2$ GeV and W threshold scan ($e^+e^- \rightarrow W^+W^-$) at $\sqrt{s} \sim 160$ GeV. The in-
8 stantaneous luminosities are expected to reach 3×10^{34} , 32×10^{34} and 10×10^{34} $\text{cm}^{-2}\text{s}^{-1}$,
9 respectively, as shown in Table 1.1. The current tentative operation plan will allow the
10 CEPC to collect one million Higgs particles or more, close to one trillion Z boson events,
11 and ten million W^+W^- event pairs.

12 In conjunction with the recording of central events, the forward luminosity monitors
13 are required to measure Bhabha scattering events to determine the delivered integrated
14 luminosity to a relative accuracy of 0.1% for the Higgs factory operation, and 10^{-4} for
15 the Z line shape scan. This imposes dedicated readout capabilities to maintain the high
16 rates of the luminosity calorimeter (LumiCal).

17 The following sections detail specifications for the on-detector front-end electronics
18 and off-detector back-end electronics for the detector subsystems and their interface to the
19 central DAQ, trigger, clock and control systems. The event builders provide data to the
20 event filters to determine the final event selection and data storage.

8.1 Trigger strategy

The specifics of the trigger system remain to be defined. At the conceptual stage, two approaches are being considered. The first is a standard approach where trigger primitives will be based on sub-detector data and correlations will be used. The back-end electronics of the sub-detectors will include trigger hardware that will be designed in a board frame compliant to the xTCA standard providing a high level of interconnectivity. The alternative approach is a trigger-less scheme that would provide a continuous stream of data processing, assuming a high fraction of the data is signal. Further study on the hardware trigger will be done before the technical design report and incorporated into the readout structure.

8.2 Readout electronics

The readout electronics of each detector subsystem consists of on-detector front-end electronics and off-detector back-end electronics. The front-end electronics directly receive the analog signals from the sensors. These signals are fed into Application Specific Integrated Circuits (ASIC) to produce digital signals that are further processed by configurable front-end chips, such as digital signal processors (DSP) and field-programmable gate arrays (FPGA), that format and buffer the data to be sent on the data link to the back-end electronics.

The specific details of how the analog signals are processed to yield buffered digital data varies depending on the each detector subsystem, as described in the Chapter 4 for the vertex detector and tracking systems, Chapter 5 for the electromagnetic and hadronic calorimeters, Chapter 7 for the muon systems, and Chapter 9 for the LumiCal. A common set of specifications for the readout electronics parameters are needed to ensure that the detector data from a CEPC collision collected across all subsystems can be fully assembled into a single event containing all measurements above threshold of all final state particles produced within the detector acceptance.

The most fundamental step in the readout is to provide synchronized data. This is achieved foremost by distributing phase-locked copies of the machine clock from the accelerator to the front-end systems that digitize and buffer the data. The specifications on the clock jitter depend on the level of precision required for timing measurements, where for reference the LHC clock distribution for the HL-LHC upgrade is expected to have an RMS jitter of less than 10 ps. The requirements for the digital transmission and event building are to keep the data aligned on the same clock boundary and depend on the speed of the data transmission, where transfer rates of 25 Gbps have been achieved. The standardization of the clock distribution and data links across the detector subsystems is advantageous to provide uniform performance and robust synchronization of the data links.

The second parameter common to all readout systems is the maximum latency for receiving a trigger decision to initiate the transfer of data from the front-end buffers to the back-end systems or from the back-end systems to the central DAQ, depending on where the data are buffered. The latency is set by the total transit time for the collision data used by the trigger to provide the data to trigger processors, to process a trigger decision, and to receive the trigger decision by the data buffers. Depending on the complexity of the triggers and internal response times of the detectors providing the data, the latency will be

1 set. With the maximum latency, the required data buffering per sub-detector will depend
 2 on the occupancy of the channels served by the same readout segment. The occupancy,
 3 channel capacity and amount of data per channel, for channels above threshold, will set the
 4 average data volume per DAQ link per trigger. The buffer needs to account for fluctuations
 5 with respect to the average to avoid buffer overrun. Control signals to monitor the data
 6 buffers and back pressure are used to throttle the trigger, as needed, to avoid data loss.
 7 Most notably, the detector data occupancies per readout segment need to model well the
 8 beam background contributions in addition to the expected occupancies from collisions.

9 The off-detector back-end readout systems will provide the data links to the trig-
 10 ger processors and the central DAQ system. Current back-end designs using Advanced
 11 Telecommunications Computing Architecture (ATCA) readout platforms are able to pro-
 12 vide a common framework for configuring the data management from different front-end
 13 systems [1, 2]. Mezzanine boards are typically implemented to allow customization of
 14 the number and types of front-end links to optimize the resources of the back-end read-
 15 out boards. The ATCA readout crates support high-speed commercial data links that can
 16 directly feed commercial network switches in the central event builder.

17 8.3 Data Acquisition System

18 The main task of the central DAQ system is to readout data from the electronics with
 19 the level-1 trigger decision given by trigger system, then build into a full event with data
 20 fragments from different sub-detectors and process data, such as data compression and
 21 event filter. Finally, the data are sent to permanent storage.

22 8.3.1 Readout Data Rate Estimation

23 The proposed CEPC detector includes seven type optional sub-detectors in the above
 24 chapters: VTX, silicon tracker, TPC, Draft chamber, ECAL, HCAL and dual-readout
 25 calorimeter.

26 Table 8.1 shows the estimated data rate of sub-detectors of CEPC. The event rate
 27 reaches ~ 32 kHz for Z factory operation from Z boson decays and Bhabha events with
 28 the 2 Tesla solenoid option ($\mathcal{L} = 3.2 \times 10^{35}$ cm²/s). We apply a safety factor and assume
 29 a maximum event rate of 100 kHz. TPC and drift chamber are two options of outer side
 30 tracker. VTX and silicon tracker assume a 10 μ s time readout window for occupancy.
 31 With the level-1 trigger operating at 100 kHz, the total raw data rate is about 2 TBytes/s.

32 8.3.2 Conceptual Design Schema

33 The current LHC experiments have up to 10^8 front-end readout channels and a maximum
 34 event building rate of 100 kHz, moving data at speeds of up to 300 GBytes/s (with an
 35 average throughput of < 200 GBytes/s required). The HL-LHC Phase-2 Upgrades reach
 36 6000 GBytes/s and average event sizes of 7.4 MBytes [1]. The proposed CEPC DAQ
 37 system has the similar requirement in terms of data throughput. Upon the reception of the
 38 data, the computing requirements for event processing at the CEPC, in terms of storage
 39 and CPU, depend on the reconstruction times and trigger algorithms. As these algorithms
 40 are evolving, the current approach is to remain as compatible as possible with the rapidly
 41 developing technologies in the computing and network markets.

	Total # channels M(10^6)	Occupancy %	Nbit /channel	# Channels readout/evt k(10^3)	Volume /evt MBytes	Data rate @ 100 kHz GBytes/s
VTX	690	0.3	32	2070	8.3	830
Silicon Tracker						
Barrel	3238	0.01 ~ 1.6	32	1508	3.15	315
Endcap	1238	0.01 ~ 0.8	32	232	0.4	40
TPC	2	0.1-8	30	1375	5	500
Drift Chamber	0.056	5-10	480	?	3	300
ECAL						
Barrel	17/7.7	0.17	32	28.8/13.1	0.117/0.053	11.7/5.3
Endcap	7.3/3.3	0.31	32	22.4/10.2	0.090/0.041	9.0/4.1
AHCAL						
Barrel	3.6	0.02	32	0.72	0.0029	0.3
Endcap	3.1	0.12	32	3.72	0.015	1.5
DHCAL						
Barrel	32	0.004	2	1.28	0.00032	0.03
Endcap	32	0.01	2	3.2	0.0008	0.08
Dual Readout Calorimeter	22	0.4-1.6	64	88-352	0.704-2.8	70-280
Muon						
Barrel	4.9	0.0002	24	0.01	< 0.0001	< 0.01
Endcap	4.6	0.0002	24	0.01	< 0.0001	< 0.01

Table 8.1: CEPC DAQ Data Rate Estimation. TPC and drift chamber are options of outer side tracker. With the level-1 trigger operating at 100 kHz, the total raw data rate is 2 TBytes/s.

1 Figure 8.1 shows the conceptual software architecture design of the CEPC DAQ
 2 based on the experience gained from BES III and DayaBay experiments. The DAQ sys-
 3 tem is connected with the sub-detector back-end electronics in counting rooms through
 4 commercial network switches with the TCP/IP protocol. For 2 TBytes/s data readout re-
 5 quirement, it need about 1600 10Gbit or 640 25Gbit network links. All other DAQ devices
 6 are deployed in a dedicated machine room. Event building will be performed on the online
 7 farm connected to the back-end electronics via network switches. An event filter will also
 8 run on an online farm. Each node of the online farm will process the data of one complete
 9 event at a time. The purpose of the online event processing will mainly be event classi-
 10 fication, data quality monitoring and online filtering to reduce background events. The
 11 DAQ system will provide other common functions including run control, run monitoring,
 12 information sharing, distributed process manager, software configure, Elog, data quality
 monitoring, remote monitoring and so on.

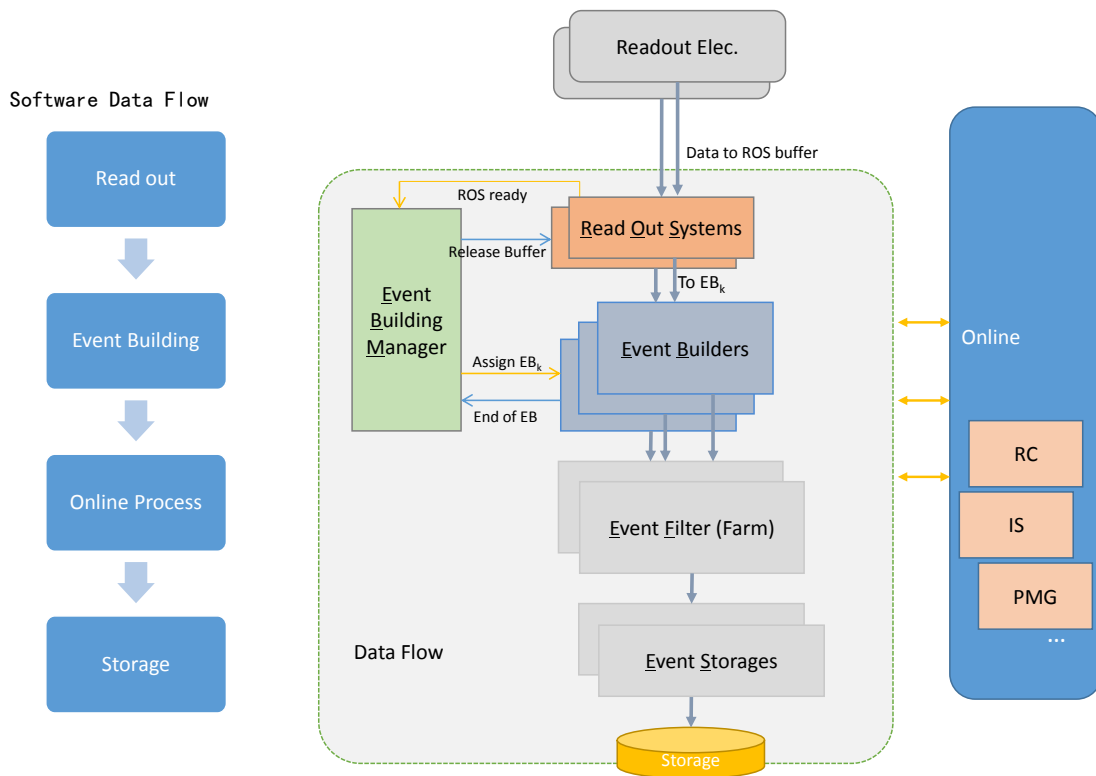

Figure 8.1: DAQ Conceptual Software Architecture Design Diagram. ROS readout data from electronics and send data to EB with EBM by data driven. After event building the event filter or software trigger will be processed at EF farm. Then the passed events will be stored at storage nodes.

13
 14 There are two levels of event building in the conceptual design data flow. The first
 15 level is implemented in readout farm which reads out the data from the back-end elec-
 16 trics and builds into a data fragment. The second level implemented in online farm which
 17 reads out the data from readout farms and builds into a full event. The two levels of event
 18 building could function according to the BES III event building as follows [2]:

- 19 1. electronics boards send data to ROS(read out system) through network.

- 1 2. ROS receive all data slice of one event and send event ID to EBM(event building
2 manager).
- 3 3. EBM assign event ID to a free EB(event builder) node when EBM get all same event
4 ID from all ROSs.
- 5 4. EB send data request to each ROSs.
- 6 5. ROSs send requested data to EB.
- 7 6. EB receive all ROSs data fragments of one event and finish full event building, then
8 send event ID back to EBM.
- 9 7. EBM send event ID to ROSs to clear data buffer.

10 A software trigger can be deployed in the event filter farm. Each event filter node
11 requests a full event from EBs, then sends the event data to process tasks to analyze for
12 software trigger and data quality monitoring, and then in the last step sends triggered event
13 to event storage nodes.

14 References

- 15 [1] J. G. Hegeman, *The CMS Data Acquisition System for the Phase-2 Upgrade*, CERN,
16 CMS-CR-2018-099 (2018) .
- 17 [2] M. Liu, J. Lang, S. Yang, T. Perez, W. Kuehn, H. Xu, D. Jin, Q. Wang, L. Li, Z. Liu,
18 et al., *ATCA-based computation platform for data acquisition and triggering in
19 particle physics experiments*, in *Field Programmable Logic and Applications, 2008.
20 FPL 2008. International Conference on*, pp. 287–292, IEEE. 2008.

MACHINE DETECTOR INTERFACE AND LUMINOSITY DETECTORS

1 The Machine-Detector Interface (MDI) represents one of the most challenging tasks for
2 the CEPC project. In general, it will have to address all common issues relevant to both
3 the machine and detector. Topics summarized in this chapter include the interaction re-
4 gion, the final focusing magnets, the detector radiation backgrounds and the luminosity
5 instrumentation. Integration of all the machine and detector components in the interaction
6 region is also briefly discussed. It is critical to achieve comprehensive understanding of
7 MDI issues to assure the optimal performance of the machine and detector.

8 9.1 Interaction region

9 The interaction region (IR) is where both electron and positron beams are focused to small
10 spot sizes at the interaction point (IP) to maximize the machine luminosity, and merged
11 but subsequently separated the two beams traveling in separate storage rings. The IR
12 layout, as illustrated in Figure 9.1, has received several necessary updates with respect to
13 the published preliminary CDR [1], to cope with the latest double-ring design and a beam-
14 crossing angle of 33 mrad. The two final focusing magnets, QD0 and QF1, sits inside the
15 detector. The focal length (L^*), defined as the distance from the final focusing magnet (*i.e.*
16 QD0) to the IP, has increased from 1.5 m to 2.2 m. This allows enlarged separation
17 between the two single apertures of the QD0. Compensating magnets are positioned in
18 front of the QD0 and surrounding both the QD0 and QF1 magnets. They are introduced
19 to cancel out the detector solenoid field and minimize the disturbance on the focusing
20 beams. Furthermore, the outer radius of the compensating magnets defines the detector
21 acceptance to be $|\cos \theta| \leq 0.993$. The luminosity calorimeter (so called “LumiCal”),
22 located right in front of the compensating magnets, is designed to measure the integrated

- 1 luminosity to a precision of 10^{-3} or better. Tracking disks, labeled as FTD, are designed
- 2 to measure charged particle trajectories in the forward region.

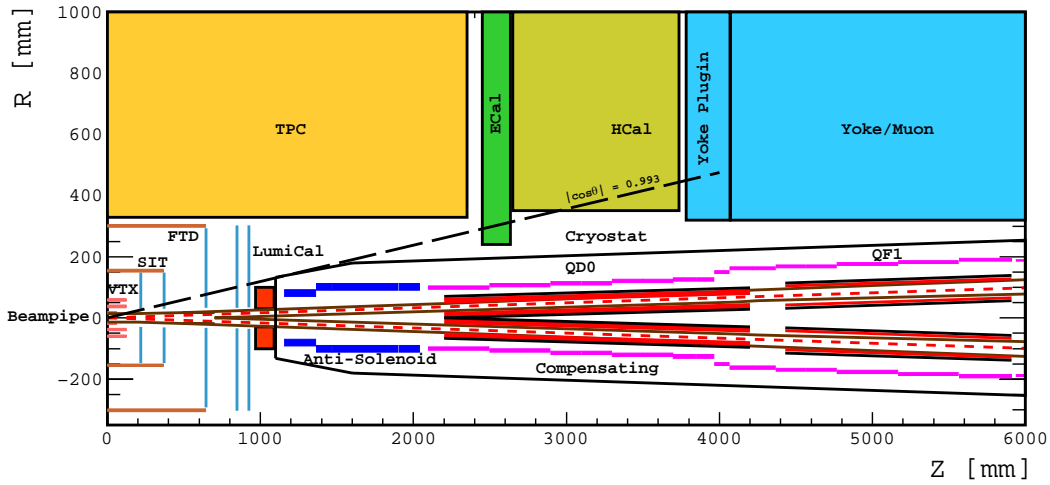

Figure 9.1: Layout of the CEPC interaction region. The two beampipes merge into one at $z = 700$ mm, with the central part of $|z| = \pm 70$ mm made with Beryllium. The two final focusing magnets (QD0 and QD1) are surrounded with the screening magnets (purple lines) and with the compensating magnet (blue lines) in front. The magnets are placed inside the cryostat. The LumiCal (red) sitting in front of the cryostat provides precise luminosity measurement. Silicon tracking detectors, VTX and SIT, are in the barrel region, while FTD disks are covering the forward region.

3 9.2 Final focusing magnets

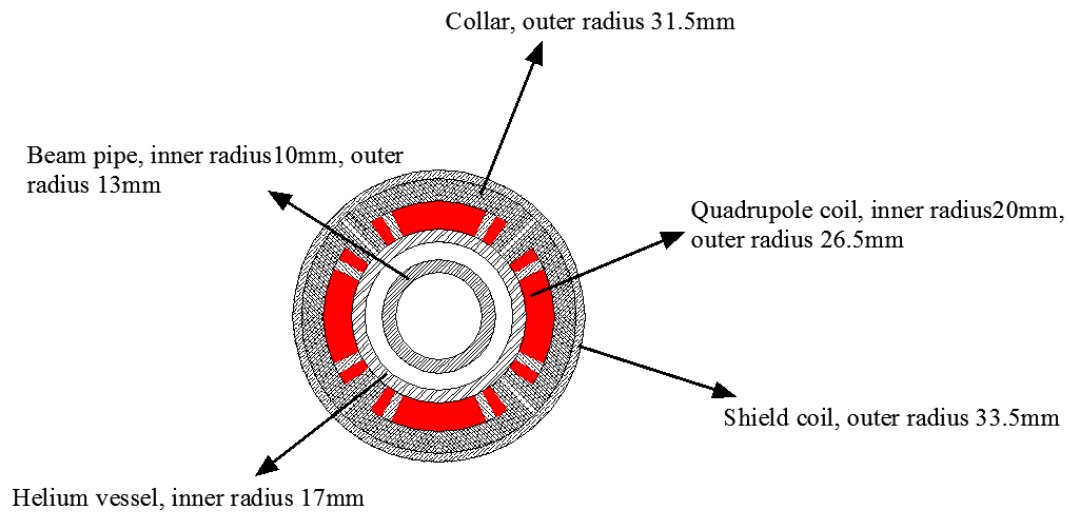

Figure 9.2: Schematic view of the single aperture of the final focusing superconducting quadrupole.

- 4 In the interaction region, compact high gradient quadrupole magnets are designed
- 5 to focus the electron and positron beams. The two final focusing quadrupoles (QD0 and
- 6 QF1), are placed inside the CEPC detector and must operate in the background field of
- 7 the detector solenoid. QD0 is the quadrupole magnet close to the interaction point, with

a distance of 2.2 m to the IP. It is designed as a double aperture superconducting magnet and can be realized with two layers of Cos-Theta quadrupole coil using NbTi Rutherford cables without iron yoke. The cross-sectional view of the single aperture of the QD0 is shown in Figure 9.2. It is designed to deliver a gradient field of 136 T/m and control the field harmonics in the sensitive area to be below 3×10^{-4} . Design parameters are summarized in Table 9.1. The QF1 magnet is similar to the QD0, except that there is an iron yoke around the quadrupole coil for the QF1.

Magnet	QD0	QF1
Field gradient [T/m]	136	110
Magnetic length [m]	2.0	1.48
Coil turns per pole	23	29
Excitation current [A]	2510	2250
Coil layers	2	2
Stored energy [kJ]	25.0	30.5
Inductance [H]	0.008	0.012
Peak field in coil [T]	3.3	3.8
Coil inner diameter [mm]	40	56
Coil outer diameter [mm]	53	69
X direction Lorentz force/octant [kN]	68	110
Y direction Lorentz force/octant [kN]	-140	-120

Table 9.1: Main design parameters of the two final focusing magnets, QD0 and QF1.

Additional compensating magnets are introduced to minimize the disturbance from the detector solenoid on the incoming and outgoing beams. The compensating magnets in front of the QD0 is designed to achieve an almost zero integral longitudinal field before entering the QD0. And the compensating magnet right outside the QD0 and QF1 is necessary to screen the detector field. The magnets are based on wound of rectangular NbTi-Cu conductors. To minimize the magnet size, the compensating magnets are segmented into 22 sections with different inner coil diameters. Inside the first section, the central field reaches the peak value of 7.2 Tesla. More detailed design of the final focusing magnets and the compensating magnets can be found in [2].

9.3 Detector backgrounds

Beam and machine induced radiation backgrounds can be the primary concern for the detector design [3–6]. They can cause various radiation damages to the detectors and electronic components, and degrade the detection performance or even kill the detector completely in the extreme case. During data-taking, high rate radiation backgrounds may significantly increase the detector occupancy and impair the data-taking capability of the detector. Therefore it is always desirable to characterize the potential backgrounds at the machine and detector design stage and mitigate their impacts with effective measures.

1 Detailed Monte Carlo simulation, along with lessons and experience learned from other
2 experiments, can serve as the basis for such studies.

3 The deleterious effects of the radiation backgrounds can be represented with hit den-
4 sity, total ionizing dose (TID), and non-ionizing energy loss (NIEL). The expected hit
5 density can be used to evaluate the detector occupancy. TID is an important quantity for
6 understanding surface damage effects in electronics. NIEL, represented in the 1 MeV neu-
7 tron equivalent fluence, is important for understanding the bulk damage to silicon devices.
8 The background simulation starts with either generating background particles directly in
9 the IR (e.g. pair production) or propagating them to the region close enough to the IR
10 (e.g. SR photons and off-energy beam particles). Particle interactions with detector com-
11 ponents are simulated with GEANT4 [7–9]. The characterization methodology for the
12 ATLAS detector background estimation [10] has been adopted. In the following, main
13 radiation backgrounds originating from synchrotron radiation, beam-beam interactions,
14 and off-energy beam particles, are discussed and their contributions are carefully evalu-
15 ated. Safety factors of ten are always applied to cope with the uncertainties on the event
16 generation and the detector simulation.

17 9.3.1 Synchrotron radiation

18 Synchrotron radiation (SR) photons are prevalent at circular machines. At the CEPC, they
19 are mostly produced in the last bending dipole magnets and in the focusing quadrupoles
20 inside the interaction region. The innermost tracking detectors can be sensitive to photons
21 above 10 keV and vulnerable to high levels of soft photon radiation ¹. In order to reduce
22 the energy and flux of SR photons that enter the straight sections, the field strength of the
23 last bending dipole magnet has been reduced and becomes much weaker than the normal
24 arc dipole fields. This controls the critical energy of SR photons to be below 100 keV and
25 makes the collimation design less difficult.

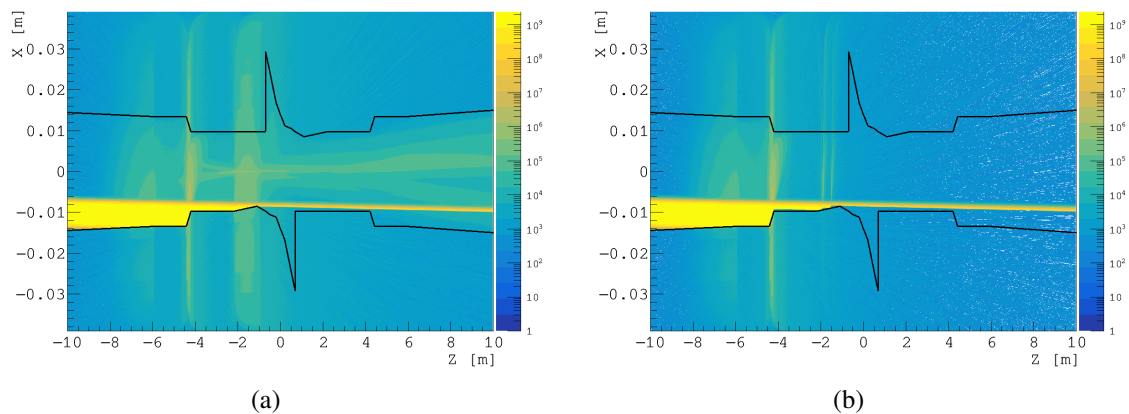

Figure 9.3: Illustration of the synchrotron photon flux formed by the upstream bending magnet on the left side and the photons scattered by the beam pipe before (a) and after (b) introducing the three mask tips at $|z| = 1.51, 1.93$ and 4.2 m.

¹It should be noted that the SR photon energy increases rapidly with the beam energy and additional measures might have to be introduced to allow detector operation at higher operation energies.

1 The BDSim [11] software based on GEANT4 has been deployed for the detailed
 2 studies. It allows generating SR photons from the relevant magnetic elements and trans-
 3 ports them to the region of the experimental detectors. Particular care has been taken for
 4 a realistic simulation in the tails of the beam density distributions (up to $10 \sigma_{x/y}$) and for
 5 both beam core and halo, as particles from the tails are most effective in producing back-
 6 ground particles. SR photons from the last dipole magnet form the light yellow band in
 7 Figure 9.3 and can hit the beam pipe in the interaction region. A considerable amount of
 8 them are scattered and can hit the central Beryllium beam pipe ($z = \pm 7$ cm) as shown
 9 in Figure 9.3(a). Collimators made with high- Z materials (e.g. Tungsten) and particular
 10 shapes are designed to block those scattering photons. Three sets of mask tips, located at
 11 $|z| = 1.51, 1.93$ and 4.2 m along the beam pipe to the interaction point, are introduced
 12 to suppress such SR photons. They can effectively reduce the number of SR photons
 13 hitting the central beam pipe from nearly 40,000 to below 80. This reduction leads to
 14 a much lower power deposition in the beam pipe and allows a simplified cooling design
 15 for the beam pipe. The resulting photon flux distribution after collimation is shown in
 16 Figure 9.3(b). SR photons generated in the final focusing magnets are also carefully eval-
 17 uated. They are highly forward and do not strike directly the central beam pipe unless the
 18 particles are $40 \sigma_x$ off the central orbit.

Machine Parameters	H (240 GeV)	W (160 GeV)	Z (91 GeV)
Beam energy [GeV]	120	80	45.5
Particles per bunch [10^{10}]	15	12	8
Transverse size σ_x/σ_y [μm]	20.9/0.068	13.9/0.049	6.0/0.078
Bunch length σ_z [μm]	3260	5900	8500
Emittance $\varepsilon_x/\varepsilon_y$ [nm]	12.1/0.0031	0.54/0.0016	0.18/0.004

Table 9.2: The input parameters to the GUINEA-PIG for the pair production simulation for the machine operations at $\sqrt{s} = 240, 160$ and 91 GeV.

19 9.3.2 Beam-beam interactions

20 Beamstrahlung and its subsequent process of pair production ($\gamma\gamma \rightarrow e^+e^-$) are impor-
 21 tant background at the CEPC. Due to the pinch effect in the beam-beam interaction, the
 22 trajectories of beam particles in the bunches are bent, which causes the emission of beam-
 23 strahlung photons. This process has been studied with the Monte Carlo simulation pro-
 24 gram GUINEA-PIG [12], which takes into account dynamically changing bunch effects,
 25 reduced particle energies and their impacts on the electric and magnetic fields. In addi-
 26 tion, the simulation program has been customized to implement the external detector field
 27 for the charged particle tracking. This allows improved determination of the positions and
 28 momenta of the out-going charged particles before interfacing to the GEANT4 detector
 29 simulation. Machine parameters for operation at different energies are listed in Table 9.2,
 30 and serve as the input to the GUINEA-PIG simulation. It should be noted that compared to
 31 other consequent processes, electron-positron pair production generates most significant
 32 detector backgrounds. The processes can be categorized as:

- 1 ▪ *Coherent Production:* e^+e^- pairs are produced via the interaction of virtual or real
2 photons (e.g. beamstrahlung photons) with the coherent field of the oncoming bunch.
3 Particles can be highly energetic but are dominantly produced with small angle and
4 confined in the beam pipe. Its contribution to the detector backgrounds is negligible.
- 5 ▪ *Incoherent Production:* e^+e^- pairs are produced through interactions involving two
6 real and/or virtual photons. Most of the particles are confined in the beam pipe by
7 the strong detector solenoid field. However, a small fraction of them are produced
8 with high transverse momentum and large polar angle. The incoherent production
9 dominates the contribution to the detector backgrounds.

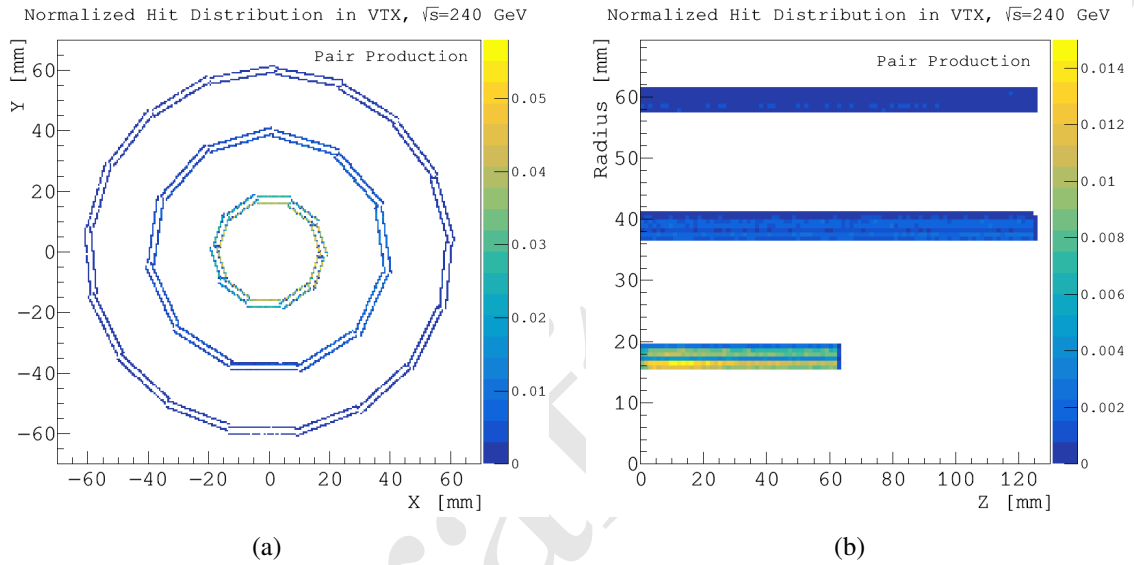

Figure 9.4: Hit distributions due to the pair production in the $x - y$ and $r - z$ planes of the vertex detector for the machine operation at $\sqrt{s} = 240$ GeV. The incoherent production dominates detector backgrounds.

10 As shown in Figure 9.4(a), the resulting hit distribution is nearly uniform in the ϕ -
11 direction, even though the beam squeezing is different in the x and y directions. On
12 the other hand, the hit distribution is more dense in the central region as shown in Fig-
13 ure 9.4(b), but decreases rapidly with the increased radius, as shown in Table 9.3.

14 9.3.3 Off-energy beam particles

15 Circulating beam particles can lose significant amounts of energy in scattering processes.
16 If exceeding 1.5% of the nominal energy (defined as the machine energy acceptance),
17 scattered particles can be kicked off their orbit. A fraction them will get lost close to or
18 in the interaction region. They can interact with machine and/or detector components and
19 contribute to the radiation backgrounds. There are three main scattering processes that
20 are almost entirely responsible for the losses of beam particles, including beamstrahlung,
21 radiative Bhabha scattering and beam-gas interaction.

22 While beamstrahlung events out of beam-beam interactions are generated with GUINEA-
23 FIG, radiative Bhabha events with small angles are generated with the BBBREM pro-
24 gram [13]. Interactions between the beam particles and the residual gas in the beam

	Hit Density [hits/cm ² ·BX]	TID [kRad/year]	NIEL [1 MeV n_{eq} / cm ² ·year]
Layer 1 ($r = 1.6$ cm)	2.2	620	1.2×10^{12}
Layer 2 ($r = 1.8$ cm)	1.5	480	9.1×10^{11}
Layer 3 ($r = 3.7$ cm)	0.18	60	1.2×10^{11}
Layer 4 ($r = 3.9$ cm)	0.15	45	1.0×10^{11}
Layer 5 ($r = 5.8$ cm)	0.03	9.7	3.3×10^{10}
Layer 6 ($r = 6.0$ cm)	0.02	6.8	3.0×10^{10}

Table 9.3: Maximum hit density, total ionizing dose (TID) and non-ionizing energy loss due to the pair production ($\gamma\gamma \rightarrow e^+e^-$) at each vertex detector layer for the machine operation at $\sqrt{s} = 240$ GeV.

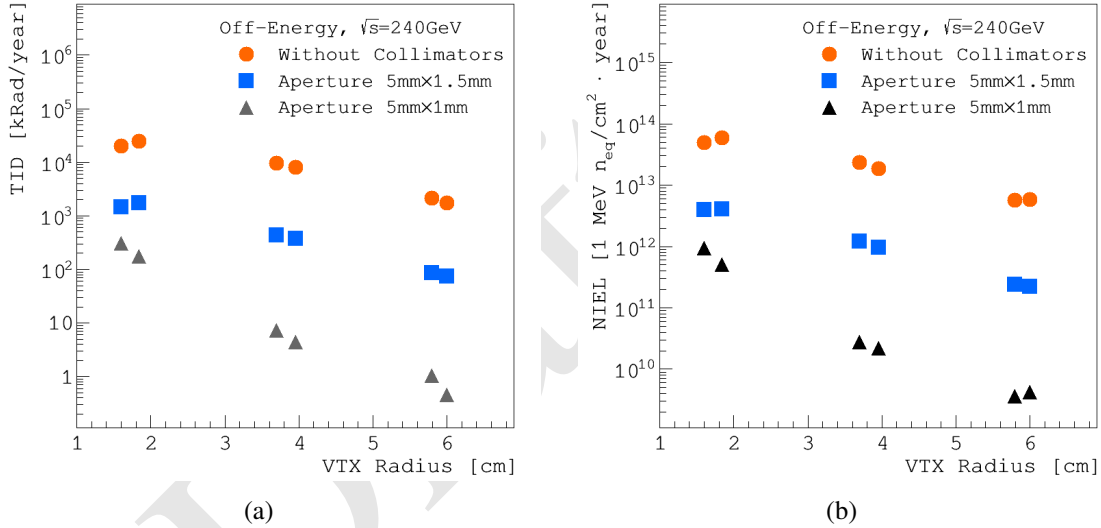

Figure 9.5: Total ionizing dose (TID) (a) and non-ionizing energy loss (NIEL) (b) caused by off-energy beam particles at each vertex detector layer are effectively reduced after introducing the two sets of collimators.

1 pipe are simulated with custom code, assuming the gas pressure to be 10^{-7} mbar. The
2 backgrounds originating from the beam-gas interaction is much smaller compared to that
3 from the Radiative Bhabha scattering. Beam particles after interactions are tracked with
4 SAD [14] and transported to the interaction region. Particles lost close to the interaction
5 region, either right after the bunch crossing or after traveling multiple turns, are interfaced
6 to detector simulation.

7 Backgrounds introduced by the off-energy beam particles can be effectively sup-
8 pressed with proper collimation. The collimator aperture has to be small enough to stop
9 as much as possible the off-energy beam particles, but must be sufficiently large without
10 disturbing the beam. Four collimators are deployed in the design. APTX1 and APTX2 ,
11 with an aperture size of 5 mm, are placed in the horizontal plane, and APTY1 and APTY2,
12 with an aperture size of 1 mm, are placed in the vertical plane. All the four collimators

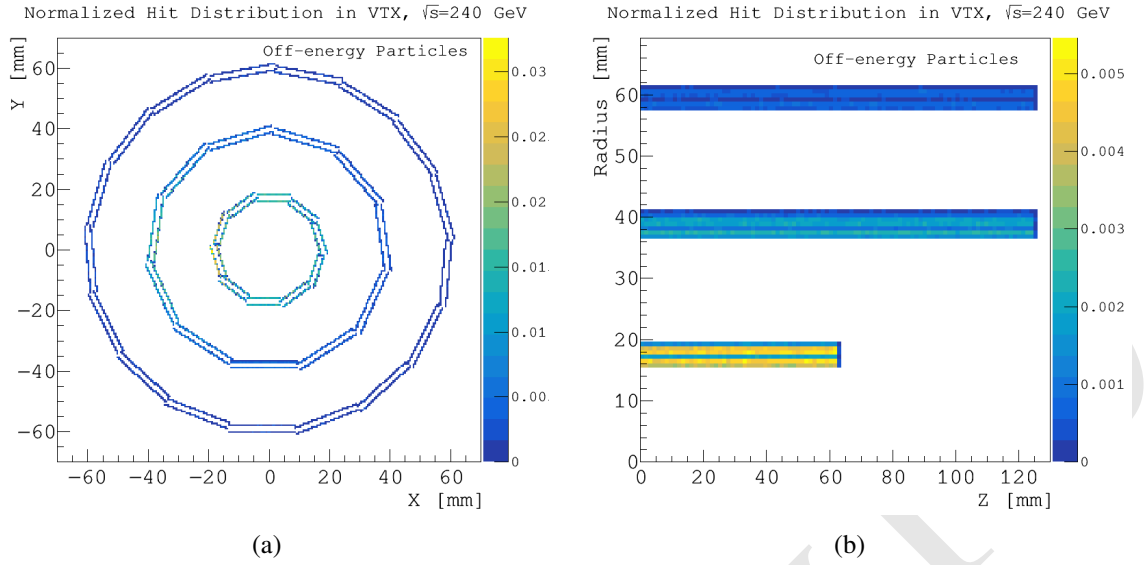

Figure 9.6: Hit distributions due to the radiative Bhabha scattering process in the $x - y$ and $r - z$ planes of the vertex detector for the machine operation at $\sqrt{s} = 240$ GeV.

1 are located in the upstream of the IP, in the range between 1700 m and 2300 m. The
 2 aperture sizes are chosen to be equivalently $14 \sigma_x$ and $39 \sigma_y$, which are sufficiently away
 3 from the beam clearance region. Figure 9.5 shows detector backgrounds from the off-
 4 energy beam particles are reduced significantly after introducing the collimation system.
 5 As shown in Figure 9.6(a), the resulting hit distribution maximizes towards the $-x$ direc-
 6 tion due to the nature of the off-energy beam particles that are swept away by the magnets.
 7 But along the z direction, the hit distribution is more or less uniform with the additional
 8 contribution of the back-scattered particles by the LumiCal in the downstream. For the
 9 background estimation, the maximum values in the $-x$ direction are taken. At the first
 10 vertex detector layer ($r = 1.6$ cm), the hit density is about 0.22 hits/cm² per bunch cross-
 11 ing from the radiative Bhabha scattering. The TID and NIEL are 310 kRad per year and
 12 9.3×10^{11} 1 MeV n_{eq} /cm² per year, respectively.

13 9.3.4 Summary of radiation backgrounds

14 When operating the machine at the center-of-mass energy of $\sqrt{s} = 240$ GeV, the main de-
 15 tector backgrounds come from the pair-production. The contribution from the off-energy
 16 beam particles is nearly an order of magnitude lower. Figure 9.7 shows the hit density,
 17 TID and NIEL at different vertex detector layers, originating from the pair production,
 18 off-energy beam particles and the two combined. In addition, TID and NIEL distributions
 19 covering the silicon detectors in $r - z$ are shown in Figure 9.8.

20 At lower operation energies, *i.e.* $\sqrt{s} = 160$ GeV for W and $\sqrt{s} = 91$ GeV for
 21 Z , the background particles are usually produced with lower energies but with higher
 22 rates given the higher machine luminosities. In addition, the pair-production dominates
 23 the radiation backgrounds and contributions from other sources become negligible. The
 24 resulting radiation backgrounds at the first vertex detector layer at different operation
 25 energies are summarized in Table 9.4.

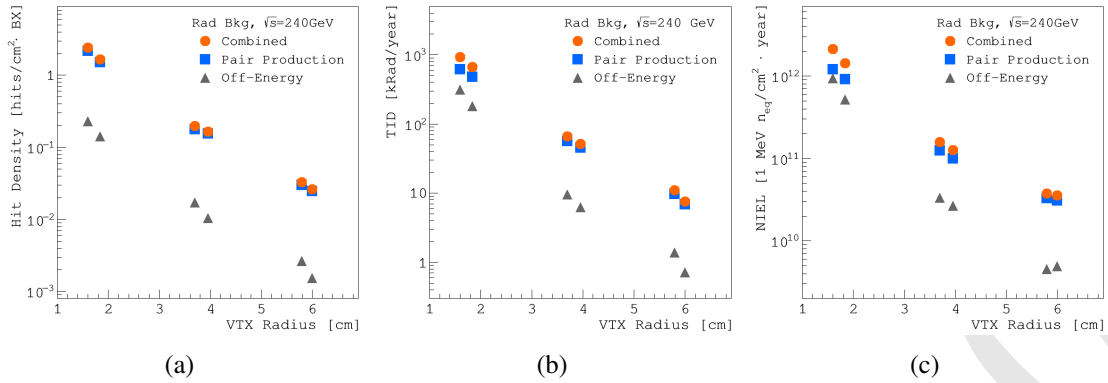

Figure 9.7: Hit density, total ionizing dose (TID) and non-ionizing energy loss (NIEL) at different vertex detector layers due to the pair production, off-energy beam particles and the two combined for the machine operation at $\sqrt{s} = 240$ GeV.

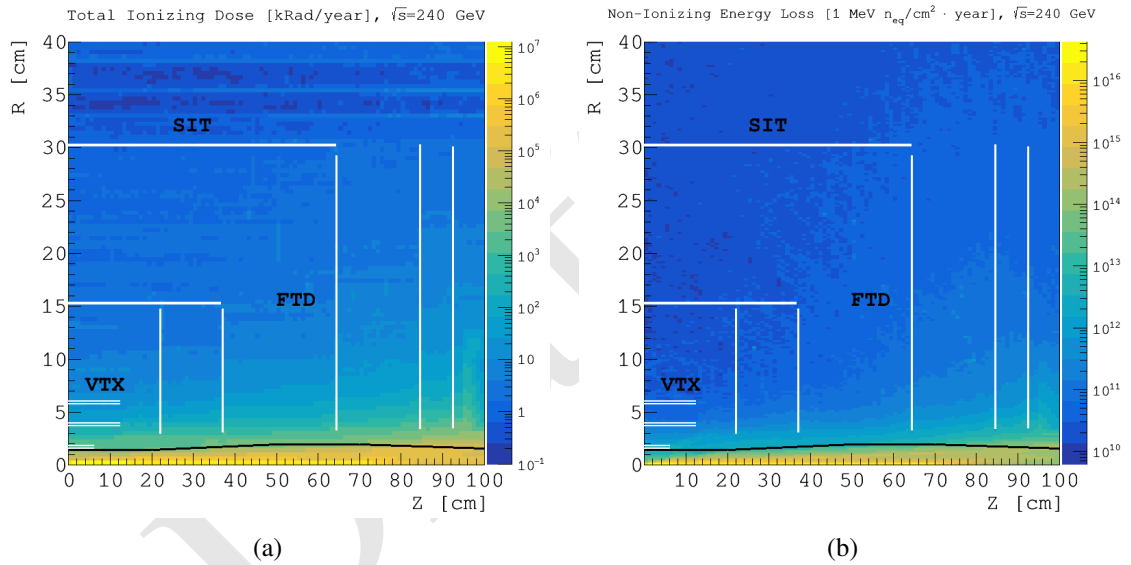

Figure 9.8: Total ionizing dose (TID) and non-ionizing energy loss (NIEL) distribution in $r - z$ for the machine operation at $\sqrt{s} = 240$ GeV. The white lines indicate the locations of the vertex detector (VTX), the forward tracking disks (FTD) and the silicon inner tracker (SIT).

	H (240)	W (160)	Z (91)
Hit Density [hits/BX]	2.4	2.3	0.25
TID [MRad/year]	0.93	2.9	3.4
NIEL [10^{12} 1 MeV $n_{eq}/\text{cm}^2 \cdot \text{year}$]	2.1	5.5	6.2

Table 9.4: Summary of hit density, total ionizing dose (TID) and non-ionizing energy loss (NIEL) with combined contributions from pair production and off-energy beam particles, at the first vertex detector layer ($r = 1.6$ cm) at different machine operation energies of $\sqrt{s} = 240, 160$ and 91 GeV, respectively.

9.4 Luminosity instrumentation

Very forward region at the CEPC will be instrumented with a luminometer (LumiCal), aiming to measure integrated luminosity with a precision of 10^{-3} and 10^{-4} in e^+e^- collisions at the center-of-mass energy of 240 GeV and at the Z pole, respectively. The precision requirements on the integrated luminosity measurement are motivated by the CEPC physics program, intended to test the validity scale of the Standard Model through precision measurements in the Higgs and the electroweak sectors with 10^6 Higgs and 10^{10-12} Z bosons. Many sensitive observables for such measurements critically depend on the uncertainty of the integrated luminosity.

Luminosity at an e^+e^- collider is best measured by counting the Bhabha events of elastic e^+e^- scattering. Its theoretical uncertainty is better than 0.05% at the Z pole [15]. The scattered electrons are distributed in the forward direction with a $1/\theta^3$ dependence. The cross section of the BHLUMI [16] simulation is illustrated in Figure 9.9(a).

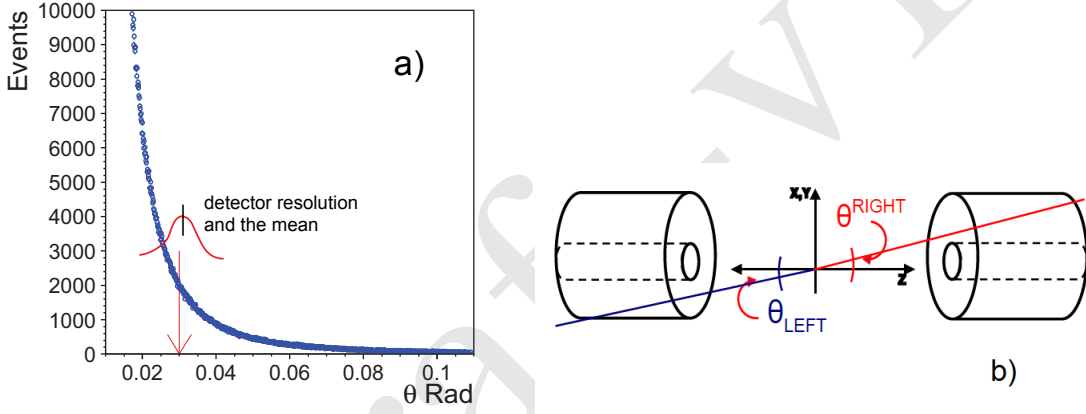

Figure 9.9: a) Distribution of scattered electrons in polar angle of the BHLUMI simulation. The Gaussian curve illustrates the detector resolution to θ measured at a given fiducial edge. The offset of the mean in measurement contributes to the systematic uncertainties. b) Bhabha events is measured preferably in the forward direction of the e^+e^- collision characterized by the back-to-back of elastic scattering and the electromagnetic shower of the electrons.

A Bhabha event is detected with a pair of scattered electrons back-to-back in direction, and the momenta of beam energy. Therefore the luminosity detector is consisted of a pair of forward calorimeters with high precision on detecting electron impact positions. The configuration is sketched in Figure 9.9(b). Bhabha events are detected in the angular coverage ($\theta_{min} < \theta < \theta_{max}$) of the forward calorimeters. The integrated luminosity (L) of the leading order calculation is

$$\sigma^{vis} = \frac{16\pi\alpha^2}{s} \left(\frac{1}{\theta_{min}^2} - \frac{1}{\theta_{max}^2} \right), \quad \mathcal{L} = \frac{1}{\epsilon} \frac{N_{acc}}{\sigma^{vis}}, \quad \frac{\Delta\mathcal{L}}{\mathcal{L}} \sim \frac{2\Delta\theta}{\theta_{min}}, \quad (9.1)$$

where ϵ is the detection efficiency. The systematic uncertainties are mostly from the precision on θ_{min} , mainly due to mechanical alignment and the detector resolution. The uncertainty propagates to the luminosity calculation is about twice on magnitude.

The dimension of the detector is favorable to have the θ_{min} as low as possible to optimize coverage of the Bhabha cross section. The luminosity detector is planned to be mounted in front of the quadrupole magnets at $z = \pm 100$ cm. With the θ_{min} of ~ 30 mrad,

1 corresponding to a radius of 30 mm to the beam pipe at $z = 100$ cm, the cross-section,
 2 σ^{vis} , after event selection will reach ~ 50 nb. A large detector coverage of σ^{vis} is neces-
 3 sary for statistics required for the Z line-shape study, where the $Z \rightarrow q\bar{q}$ cross section is
 4 41 nb. The precision required for 10^{-4} makes a strong demand on the detector resolution.
 5 At $\theta = 30$ mrad, it corresponds to an offset of $\Delta\theta \sim 1.5 \mu\text{rad}$, which is equivalent to
 6 $1.5 \mu\text{m}$ in radius at $z = 100$ cm.

7 Several technological options for LumiCal design are under study, as described in
 8 Sec. 9.4.1, with emphases on the precision of polar angle and energy reconstruction of
 9 Bhabha particles scattered in the t -channel $V(V = \gamma, Z)$ exchange. The dual beam-pipe
 10 configuration with the beam-crossing at 33 mrad results to a boost to particles of e^+e^- col-
 11 lisions. The back-to-back characteristics of Bhabha electrons is shifted by approximately
 12 a horizontal offset of 33 mm. The impact to LumiCal design is discussed. The LumiCal
 13 together with the quadruple magnet are inserted into the tracking volume that extended to
 14 $z = \pm 200$ cm. Shower leakage of electrons off the LumiCal to central tracker is studied
 15 by simulation, which is also discussed.

16 LumiCal at the CEPC is a precision device with challenging requirements on the me-
 17 chanics and position control. Precision requirements on integral luminosity measurement
 18 set the precision of the opening aperture and positioning control of the LumiCal. Various
 19 sources of luminosity uncertainty in this respect are reviewed in Sec. 9.4.2. Encouraging
 20 estimations on feasibility of the luminosity precision goals are presented. Detailed studies
 21 are ongoing, to include the full simulation of physics and machine induced processes and
 22 of the detector itself, for various LumiCal positioning and technology choices.

23 9.4.1 Technological and design options

24 In the current design of the very forward region at the CEPC, LumiCal is foreseen to cover
 25 the polar angle region between 26 mrad and 105 mrad what translates into the detector
 26 aperture of 25 mm for the inner radius and 100 mm for the outer, at $z = \pm 100$ cm of the
 27 LumiCal front plane from the IP. The detector options shall be considered for

- 28 1. precision of the electron impact position to $r \sim 10 \mu\text{m}$ ($1 \mu\text{m}$) for the uncertainties on
 29 luminosity, corresponding to the systematic uncertainties on luminosity of $\Delta L/L \sim$
 30 10^{-3} (10^{-4}) in the Higgs (Z -pole) operations;
- 31 2. monitoring of the detector alignment and calibration of detector position by tracking
 32 of Bhabha electrons with upstream detectors;
- 33 3. energy resolution and separation of e/γ for measurements of single photons and ra-
 34 diative Bhabha events;
- 35 4. maximum coverage and segmentation of the LumiCal to accommodate the dual beam-
 36 pipe and the beam crossing of 33 mrad;
- 37 5. minimizing shower leakage into the central tracking volume.

38 The detector option for the $1 \mu\text{m}$ precision on electron impact position is very much
 39 limited silicon detectors segmented in strips or pixels. Silicon strip detectors of $50 \mu\text{m}$
 40 readout pitch is commonly reaching a resolution of $\sigma \sim 5 \mu\text{m}$. The uncertainty on the
 41 mean ($\bar{\sigma} = \sigma/\sqrt{n}$) would be much smaller. The selection of Bhabha events is set on
 42 a fiducial edge of θ_{min} , for example, center in the gap between two silicon strips. The

1 systematic uncertainty is therefore the number of events being selected with an uncertainty
 2 of $\bar{\sigma}$ despite the detector resolution, and would be relatively small, which is indicated by
 3 the Gaussian curve in Figure 9.9(a). The alignment of the detector position would be the
 4 major systematic requirement for an absolute precision of $1 \mu\text{m}$.

5 A conceptual Luminosity detector is illustrated in Figure 9.10 for the combination
 6 of a silicon detector and a calorimeter around the beam pipe for measurement of the elec-
 7 tron impact position energy. The segmentation of the calorimeter is considered for the
 8 back-to-back resolution detecting a pair of Bhabha electrons, and for separation of e/γ in
 9 case of radiative photon accompanied with the electron or from beam background. The
 10 thickness is determined for the energy resolution favorable of $> 20X_0$ for shower con-
 11 tainment of a 50 GeV electron. The option on the calorimeter is limited by the space
 12 available. The traditional crystal or scintillator-based calorimeter will require more than
 13 20 cm in length for $> 20X_0$. The most compact design would be a sandwiched stack
 14 of Silicon samplers with Tungsten in $1X_0$ (3.5 mm thick), to a total of about 10 cm that
 15 weights about 400 kg.

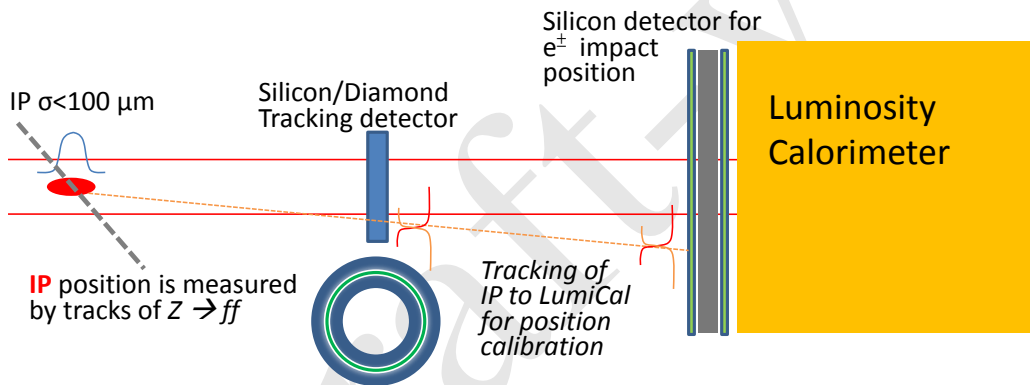

Figure 9.10: A conceptual luminosity detector combination with an upstream silicon/diamond detector for tracking Bhabha electrons to calibrate position of the luminosity detector.

16 The alignment precision of the front-layer Silicon detector is the most critical issue
 17 to reach $1 \mu\text{m}$ in radius for the luminosity measurement of 10^{-4} . For the precision at
 18 the $1 \mu\text{m}$ level, a monitoring system with laser alignment is required to calibrate the
 19 detector position. The θ angle of a detected electron is calculated assuming an IP position
 20 measured by the beam steering and the central tracking system. The IP position relative
 21 to the luminosity detector could be limited to survey relative to central tracking devices
 22 or beam pipe. If feasible, a tracking system on the Bhabha electrons will improve the
 23 measurement precision of the electron theta angle. This is illustrated in Figure 9.10 for
 24 the option that a ring of silicon or diamond detector is mounted in front of the Luminosity
 25 detector. Such that a electron track is measure from the IP, the ring detector, and the
 26 LumiCal impact position. The ring detector offers a second survey, and by extrapolation,
 27 to calibrate the LumiCal silicon strip positions.

28 The front silicon layer of the luminosity detector will measure electron impact posi-
 29 tions to a few micron. If this will be a fine-pitch strip detector, the position is measured by
 30 strips collecting the ionization charges generated by a traversing electron. In Figure 9.11,
 31 the charge sharing is illustrated for $\eta = Q_r/(Q_r + Q_l)$ with the ionization charges col-

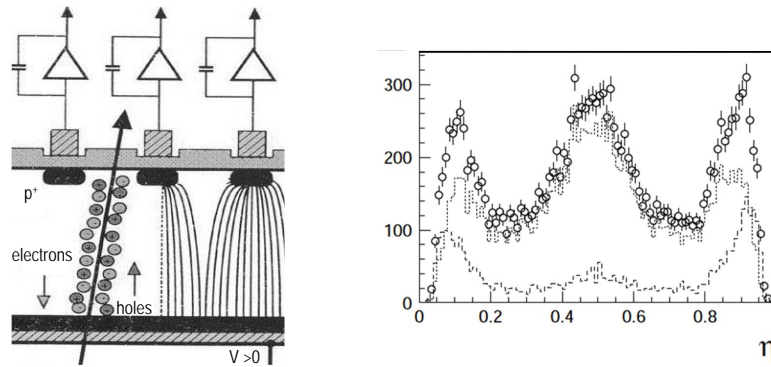

Figure 9.11: Charge collection by silicon strips is illustrated for ionization charges generated by a traversing particle. The $\eta = Q_r/(Q_r + Q_l)$ distributions are made for charge sharing to left and right strips to the impact position, for a test device with strip implementation in $25 \mu\text{m}$ pitch and the readout of every other strips in $50 \mu\text{m}$ pitch. The η distributions are also plotted for contents with charges collected by two-strip (dotted) and three-strip (dashed) cases. The middle bump corresponds to the position of the floating strip between two readout strips.

1 lected by the strips on the right (left) of the impact position. The distribution is collected
 2 for a test device having the strips implanted in $25 \mu\text{m}$ pitch, and the readout in $50 \mu\text{m}$
 3 pitch by wire bonding to every other strips. The floating strip between two readout strips
 4 attracts charges drifting towards it and results to the bump at $\eta \sim 0.5$, in particular for
 5 a wide cluster of charges collected by three strips (dotted line). The impact position of
 6 a particle is approximated by its center-of-gravity weighted on the charges between two
 7 strips. With the η distribution, the non-linear distribution can be corrected to achieve a
 8 position resolution of better than $\sim 5 \mu\text{m}$ for the readout pitch of $50 \mu\text{m}$. With the strip
 9 detectors placed in a magnetic field, the ionization charge in the silicon wafer is drifted
 10 toward one side, and therefore the η distribution is tilted un-evenly. Without a proper cor-
 11 rection for the η , the true impact position the off-set can be as large as half the readout
 12 pitch.

13 If the luminosity detector will be assembled in a sandwiched silicon-tungsten calorime-
 14 ter with the type of silicon wafer for the front layer. Wide silicon strips may be chosen
 15 in a case like the OPAL LumiCal [17], applying 2.5 mm wide strips in circular span of
 16 11.25° . The resolution on detection of an electron, as well as for e/γ separation is at the
 17 1 mm level. Assuming that the event counting of Bhabha electrons has the fiducial edge,
 18 θ_{min} , chosen at the middle between two strips, and the events are evenly divided to left
 19 and right strips without charge sharing. The systematic uncertainty to luminosity mea-
 20 surement is by the alignment uncertainty of the strip position of a few microns, and is not
 21 by the resolution.

22 Charge sharing between the gap of two-strips have been studied with prototype
 23 wafers[18] shown in Figure 9.12. The wafer dimension is $65 \times 65 \text{ mm}^2$ implemented
 24 with 2 mm wide strips and the gaps from $50 \mu\text{m}$ to $160 \mu\text{m}$. The beam test was conducted
 25 with a set of fine-pitched strip detectors as a telescope to provide reference positions of
 26 incident electrons scattered across strips and gaps. The charge sharing for electrons in
 27 the gaps are compared for η distributions in Figure 9.12, which are found compatible for
 28 the different gap widths. Charge collection shows no loss, and are drifted toward the near
 29 strips with the η peaking at the edges. The dispelling charges in the middle of a gap is

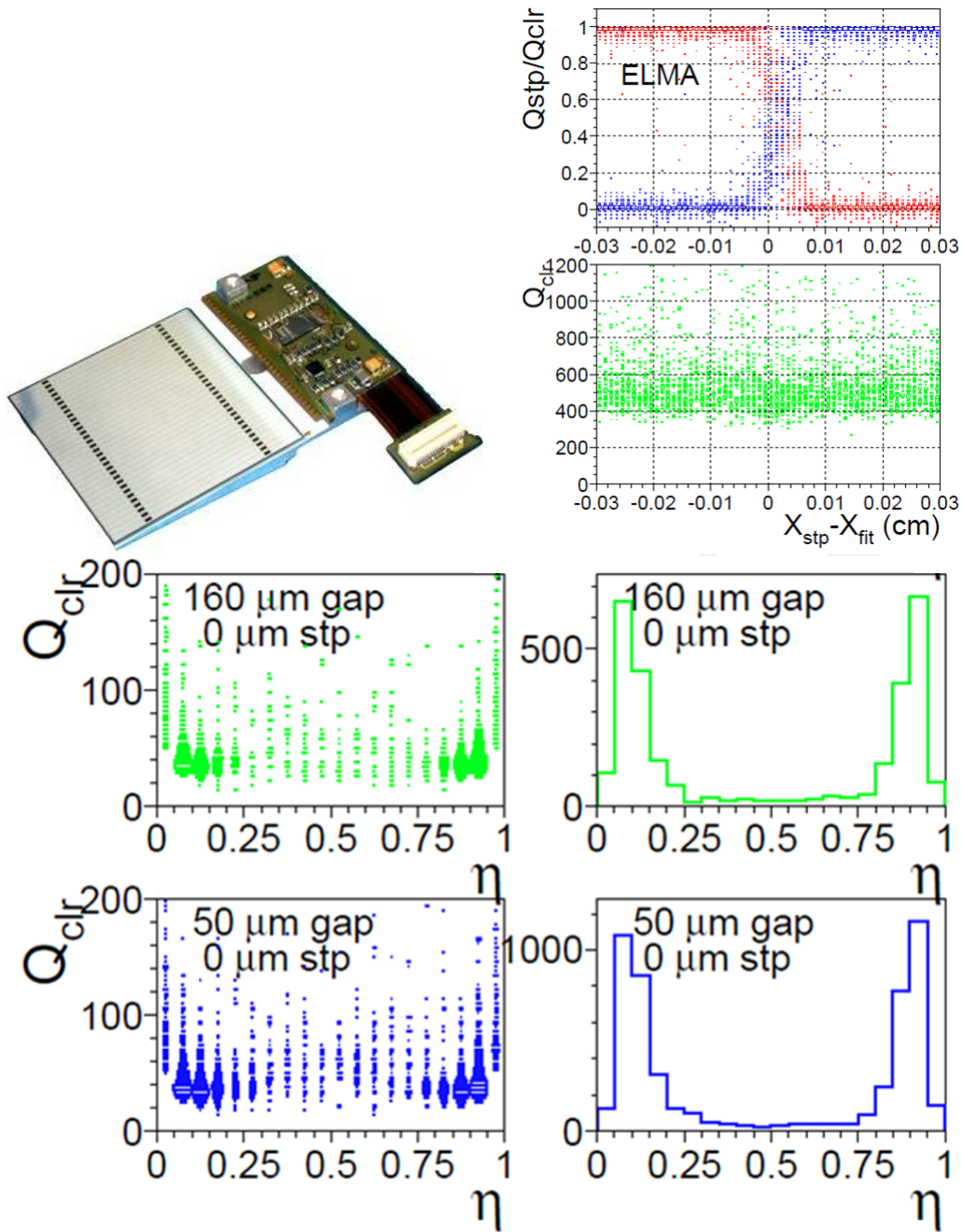

Figure 9.12: Beam tests using prototype silicon wafer of the CMS pre-shower detector (top-right) were conducted for collection of ionization charges generated by traversing particles across the gap between strips. The charge sharing by adjacent strips are plotted (top-left) to the reference impact position (X_{fit} extrapolation of a upstream telescope). The sum strip charges is compatible to the hits on a strip. The charge sharing in $\eta = Q_r/(Q_r + Q_l)$ peaks near 0 and 1 (bottom), indicating non-linear response to the randomly distributed beam particles across the gap.

- 1 difficult for deriving the position of an incident electron in the gap. But, it does divide the
- 2 event fraction cleanly to the near side of the strips.

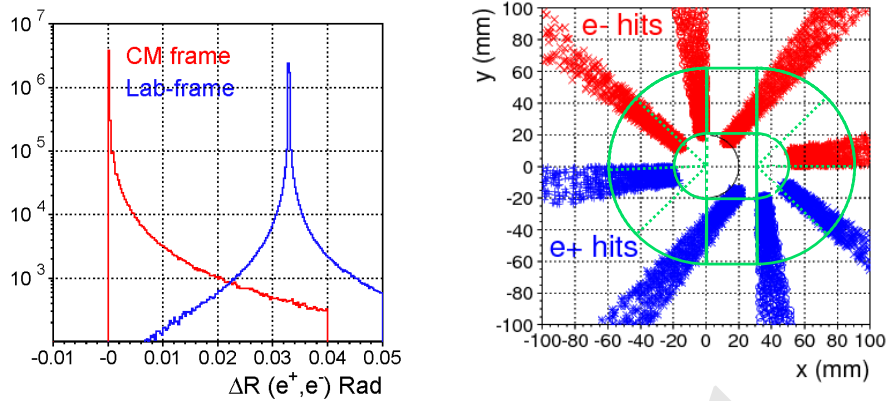

Figure 9.13: Bhabha events of BHLUMI simulation at the Z -pole are plotted for the back-to-back opening angle of scattered electron-positron pairs in the Center-of-Mass and the laboratory frames (left). The impact positions on the LumiCal front face are plotted in slides of ϕ angles every 45 degrees (right). The detector coverage is illustrated in green lines indicating a beam-pipe of 20 mm, extended from beam center at $x = \pm 16.5$ mm.

1 The double ring configuration of the CEPC machine design at the interaction point
 2 has a beam crossing angle of 33 mrad. The effect to the electrons of Bhabha interaction
 3 is a boost off the accelerator ring center, by maximum 16.5 mrad in horizontal direction.
 4 The distribution is simulated with the BHLUMI program. The shift on back-to-back angle
 5 is plotted in Figure 9.13. The boost is toward $+x$ direction of the laboratory frame. The
 6 electron impact positions on the LumiCal front-layer at $z = 100$ cm are also plotted in
 7 Figure 9.13, in slices of every 45 degrees to indicate the dependence on p_T direction. The
 8 beam-pipe centers are at $x = \pm 16.5$ mm. The green lines indicate the beam-pipe area of
 9 20 mm in radius extending horizontally, and the coverage of the LumiCal in segmentation
 10 of circular and rectangular silicon wafers. The electron impact positions are illustrated
 11 for >20 mrad to the laboratory frame. Electrons of low scattering angles, in particular
 12 for those in $-x$ direction, are lost into beam-pipe. To have both scattered electrons and
 13 positrons detected, the corresponding θ_{min} on the horizontal axis is the beam-pipe accep-
 14 tance plus 16.5 mrad. The loss of events on vertical direction is much less. With a beam
 15 pipe as indicated with $\pm y$ dimension equals radius, the horizontal boost does not lead to
 16 the loss of electrons with a larger y -position. A large detector coverage for Bhabha events
 17 is most favorable. The large opening of beam-pipe position is inevitable. We shall pursue
 18 the vertical dimension to be low as possible for a total integrated Bhabha cross section of
 19 larger than 50 nb.

20 The LumiCal mounted in front of the quadrupole magnet at $z = \pm 100$ cm is half way
 21 in the tracking volume of $z = \pm 200$ cm. Shower leakage of electrons at the edge of Lumi-
 22 Cal is investigated with a GEANT simulation with parameters cross-checked with a lateral
 23 shower study [19]. The LumiCal is configured assuming a sandwiched Silicon-Tungsten
 24 calorimeter stacked in twenty decks of 2 mm air-gap and $1X_0$ tungsten. The air-gap has
 25 a layer of silicon wafer of 0.3 mm thick. The front layer of the LumiCal is positioned at
 26 $z = \pm 100$ cm. The geometry of the LumiCal is tested in two configurations: a TUBE
 27 with uniform inner and outer radii of 25 and 100 mm, respectively; and a CONE shape
 28 with the outer edge at a constant angle of $\arctan 0.1$ to the interaction point. The CONE

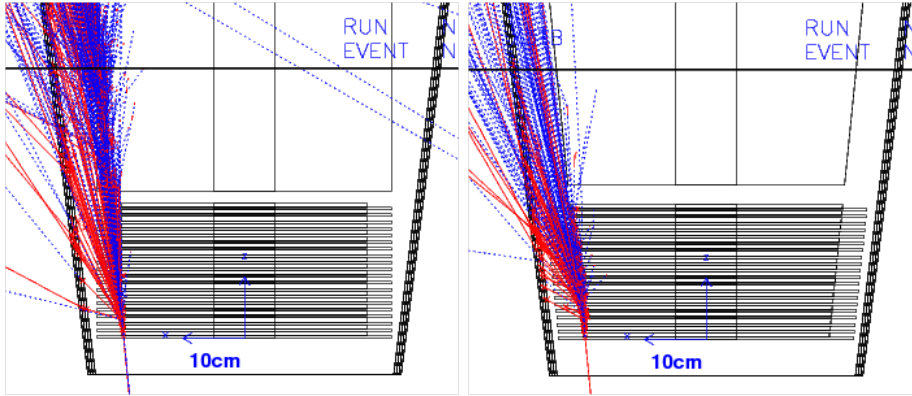

Figure 9.14: Event display of a GEANT simulation for electron shower on the LumiCal configuration stacked with 20 decks of silicon and Tungsten layers in TUBE (left) and CONE (right) shapes.

1 shape is intended for well separated absorption of electron shower in a theta threshold.
 2 Illustrated in Figure 9.14 are the event display of the simulations. Out of the LumiCal, a
 3 5 mm iron cone at $|\cos \theta| = 0.992$ is implemented for absorption of low energy shower
 4 secondaries massing into the center tracking volume.

5 The TUBE configuration leaves a corner of about 5 mrad on the outer edge, where
 6 the shower leakage of an incident electron is with energetic shower secondaries. The
 7 CONE shape allows the shower fully developed once the electron enters the calorimeter
 8 coverage. The shower leakage reaching the Fe-cone is recorded for the particle energies
 9 arriving and penetrating through, which are listed in Table 9.5 for 50 GeV and 125 GeV
 10 electrons. When the shower is well contained, the leakage is just a few dozens of less than
 11 30 MeV particles. A shower on the edge creates up to 3k secondaries into the tracking
 12 volume mostly of less than 100 MeV. The 5 mm iron layer can filter a large fraction of
 13 them, to less than 1k particles traversing through.

θ (mrad)	50 GeV electrons		125 GeV electrons	
	TUBE	CONE	TUBE	CONE
	$N_{\text{enter}}/N_{\text{pass}}$	$N_{\text{enter}}/N_{\text{pass}}$	$N_{\text{enter}}/N_{\text{pass}}$	$N_{\text{enter}}/N_{\text{pass}}$
40	15.4/5.6	13.6/5.8	38.0/16.0	35.8/14.7
90	392/155	173/76	1028/399	434/19.7
95	501/290	367/152	2389/720	937/382
98	762/216	860/284	1718/473	2176/725
99	553/140	1331/367	1102/273	3306/915

Table 9.5: Number of particles leaking out of the LumiCal outer radius (N_{enter}) and number of particles passing through the Fe-cone (N_{pass}). Two different detector designs (TUBE and CONE) and two shower energies (50 GeV and 125 GeV) are simulated. A shower on the edge creates up to 3k secondaries toward the tracking volume, which are mostly of less than 100 MeV and are filtered by the 5 mm thick Fe-cone.

9.4.2 Systematic effects

The main measure of luminosity at the CEPC is the count of Bhabha events N_{Bh} detected in coincidence in the two halves of the luminosity calorimeter LumiCal. The luminosity figure is then obtained from the equation of $\mathcal{L} = N_{\text{acc}}/(\epsilon\sigma^{\text{vis}})$. The visible cross section for the Bhabha process, σ_{vis} , should be integrated over the same phase space as used for the counting of Bhabha events. The limited precision with which the experimental acceptance region is defined gives rise to a number of systematic effects. Further, other processes misidentified as Bhabha and the limited accuracy of the theoretical calculation of σ_{vis} contribute to the overall systematic uncertainty.

A generator-level study was performed to assess the effects related to the precision of the Bhabha acceptance region on Bhabha counting. An underlying assumption of the study is that the LumiCal is centered on the outgoing beam axis. This assumption is essential for data-driven control of the radial offset of LumiCal with respect to the IP, as well as for Bhabha event counting based on the mirrored asymmetric polar-angle acceptance regions on the left and right side of the detector [17] (in further text, *OPAL-style selection*). OPAL-style counting cancels out biases due to left-right asymmetries of the experimental angular acceptance. It is further assumed that for the final state particles hitting the radial region between 50 mm and 75 mm, corresponding to the detector fiducial volume (FV), shower leakage has a negligible effect on the reconstruction of the polar angle and the energy.

Bhabha event samples are generated using the BHLUMI generator [16]. Center-of-mass energy of 240 GeV is assumed, corresponding to approximately the energy of the maximum Higgs boson production cross section. The particles are generated in the range of polar angles including a ~ 7 mrad margin outside the FV to allow non-collinear final state radiation (FSR) to contribute to the events. After event generation, smearing is applied to the final particle vertices and momenta according to the nominal CEPC parameters. Additional smearing or bias is then applied according to one systematic effect at a time. Four momenta of close-by particles are summed up to account for cluster merging in LumiCal. The selection criteria to count an event consist of the OPAL-style angular selection and the requirement that the energy of both detected showers is above 50% of the nominal beam energy. The relative acceptance bias is determined as the relative difference between the Bhabha count $N_{\text{Bh},i}$ obtained with the inclusion of the considered effect i and N_{Bh} obtained with the nominal set of parameters.

Table 9.6 lists the requirements on beam delivery, MDI and LumiCal installation, needed to limit individual systematic effects in the luminosity measurement to 1×10^{-3} , such as required for the Higgs boson physics program at the CEPC. Parameters influencing the integral luminosity precision are given as follows:

- ΔE_{CM} , uncertainty of the available center-of-mass energy affecting the Bhabha cross-section,
- $E_{e^+} - E_{e^-}$, asymmetry of the incident beam energies resulting in a net longitudinal boost of the event,
- $\frac{\delta\sigma_{\text{beam}}}{\sigma_{\text{beam}}}$, uncertainty of the beam energy spread,
- Δx_{IP} and Δz_{IP} , radial and axial offsets of the IP w.r.t. the LumiCal,
- Beam synchronization, resulting in axial offset of the IP w.r.t. the LumiCal,

Parameter	Unit	Limit
ΔE_{CM}	MeV	120
$E_{e^+} - E_{e^-}$	MeV	240
$\frac{\delta\sigma_{E_{\text{beam}}}}{\sigma_{E_{\text{beam}}}}$		effect canceled
Δx_{IP}	mm	<1
Δz_{IP}	mm	10
Beam synchronization	ps	7
$\sigma_{x_{\text{IP}}}$	mm	1
$\sigma_{z_{\text{IP}}}$	mm	10
r_{in}	mm	10
$\sigma_{r_{\text{shower}}}$	mm	1
Δd_{IP}	μm	500

Table 9.6: Requirements on beam delivery, MDI and LumiCal installation, needed to limit individual systematic effects to $< 1 \times 10^{-3}$.

- 1 ▪ $\sigma_{x_{\text{IP}}}$ and $\sigma_{z_{\text{IP}}}$, radial and axial fluctuations of the scattering position,
- 2 ▪ r_{in} , inner radius of the LumiCal acceptance region,
- 3 ▪ $\sigma_{r_{\text{shower}}}$, reconstruction precision of the radial shower coordinate,
- 4 ▪ Δd_{IP} , uncertainty of the distance between the LumiCal halves.

5 Most requirements are technically feasible with the present state of the art of accel-
6 erator and detector technology. The most important challenge identified is the precision
7 of the inner acceptance radius r_{in} of LumiCal. In order to keep the luminosity precision
8 of 1 per mille, r_{in} must be known to within $10 \mu\text{m}$. The precision requirement of r_{in}
9 scales linearly with the required luminosity precision, implying a correspondingly stricter
10 requirement for the Z -pole run.

11 9.4.3 Summary on LumiCal

12 Instrumentation of the very forward region is very important for the realization of the
13 CEPC physics program. Several technology options are under consideration. Some of
14 them have been successfully applied at LEP or are under study for other future projects.
15 A tracker placed in front of the LumiCal can improve polar angle measurement accu-
16 racy, facilitate LumiCal alignment and enable electron-photon separation. LumiCal must
17 be centered on the outgoing beam axis to allow control of the systematic effects at the
18 required level. Precision requirements on beam delivery, MDI and LumiCal installation
19 have been addressed by simulation, and proven to be feasible with the present state-of-
20 the-art of accelerator and detector technology.

9.5 Detector integration

Both QD0 and QF1 are located inside the detector, which drastically complicates the support and alignment of the detector and machine components in the interaction region. The two final focus magnets and the LumiCal will possibly be mounted on a dedicated support structure, extended from a pillar outside the detector and suspended from the solenoid cryostat. They might have to be integrated together before being pushed into the interaction region. The amount of material in front of the LumiCal must be minimized so that the high precision of the LumiCal can be maintained. This shall inevitably introduce more complexities to the detector integration. Furthermore, the shaped beam pipe and surrounded silicon detectors will possibly be supported from a structure of carbon fiber reinforced plastic, which can hang at the flanges of the field cage of the Time Projection Chamber (TPC). Significant effort is required to realize a solid mechanical design and to define a reasonable procedure for the detector and machine installation scheme.

References

- [1] The CEPC-SPPC Study Group, *CEPC-SPPC Preliminary Conceptual Design Report, Volume I - Physics and Detector*, . IHEP-CEPC-DR-2015-01, IHEP-TH-2015-01, IHEP-EP-2015-01.
- [2] The CEPC Study Group, *CEPC Conceptual Design Report, Volume I - Accelerator*, . IHEP-CEPC-DR-2018-01, IHEP-AC-2018-01, to be published.
- [3] G. von Holtey et al., *Study of beam-induced particle backgrounds at the LEP detectors*, *Nucl. Instr. and Meth.* **A403** (1998) 205 – 246.
- [4] P. M. Lewis et al., *First Measurements of Beam Backgrounds at SuperKEKB*, [arXiv:1802.01366](https://arxiv.org/abs/1802.01366) [physics.ins-det].
- [5] D. S. Denisov et al., *Machine-Related Backgrounds in the SiD Detector at ILC*, *JINST* **1** (2006) P12003, [arXiv:hep-ex/0608001](https://arxiv.org/abs/hep-ex/0608001) [hep-ex].
- [6] B. Dalena, J. Esberg, and D. Schulte, *Beam-induced backgrounds in the CLIC 3 TeV CM energy interaction region*, in *International Workshop on Future Linear Colliders (LCWS11) Granada, Spain, September 26-30, 2011*. 2012. [arXiv:1202.0563](https://arxiv.org/abs/1202.0563) [physics.acc-ph].
- [7] GEANT4 Collaboration, S. Agostinelli et al., *GEANT4: A Simulation toolkit*, *Nucl. Instrum. Meth.* **A506** (2003) 250–303.
- [8] J. Allison et al., *Geant4 developments and applications*, *IEEE Trans. Nucl. Sci.* **53** (2006) 270.
- [9] Geant4 Collaboration, M. Asai et al., *Recent developments in Geant4*, *Annals Nucl. Energy* **82** (2015) 19–28.
- [10] S. Baranov, I. Dawson, M. Shupe, A. Nisati, M. Bosman, and V. Hedberg, *Estimation of radiation background, impact on detectors, activation and shielding optimization in ATLAS*, 2005. ATL-GEN-2005-001, ATL-COM-GEN-2005-001, CERN-ATL-GEN-2005-001.

- 1 [11] I. Agapov, G. A. Blair, S. Malton, and L. Deacon, *BDSIM: A particle tracking code*
2 *for accelerator beam-line simulations including particle-matter interactions*, *Nucl.*
3 *Instrum. Meth.* **A606** (2009) 708–712.
- 4 [12] D. Schulte, *Beam-beam simulation with GUINEA-PIG*, In 5th International
5 Computational Accelerator Physics Conference (1998) . CLIC-NOTE 387.
- 6 [13] R. Kleiss and H. Burkhardt, *BBBREM – Monte Carlo simulation of radiative*
7 *Bhabha scattering in the very forward direction*, *Comput. Phys. Commun.* **81**
8 (1994) 372 – 380.
- 9 [14] K. Oide and H. Koiso, *Anomalous equilibrium emittance due to chromaticity in*
10 *electron storage rings*, *Phys. Rev.* **E49** (1994) 4474–4479.
- 11 [15] S. Jadach, *Theoretical error of luminosity cross-section at LEP*, in *Electroweak*
12 *precision data and the Higgs mass. Proceedings, Workshop, Zeuthen, Germany,*
13 *February 28-March 1, 2003*, pp. 85–95. 2003. [arXiv:hep-ph/0306083](https://arxiv.org/abs/hep-ph/0306083)
14 [[hep-ph](https://arxiv.org/abs/hep-ph/0306083)].
- 15 [16] S. Jadach et al., *Upgrade of the Monte Carlo program BHLUMI for Bhabha*
16 *scattering at low angles to version 4.04*, *Comput. Phys. Commun.* **102** (1997)
17 229–251.
- 18 [17] OPAL Collaboration, G. Abbiendi et al., *Precision luminosity for Z0 line shape*
19 *measurements with a silicon tungsten calorimeter*, *Eur. Phys. J.* **C14** (2000)
20 373–425, [arXiv:hep-ex/9910066](https://arxiv.org/abs/hep-ex/9910066) [[hep-ex](https://arxiv.org/abs/hep-ex/9910066)].
- 21 [18] P. Bloch et al., *Performance Study of Non-Irradiated Prototype Silicon Preshower*
22 *Samplers for CMS*, 2000. CMS-NOTE-2000-042.
- 23 [19] Y. Chang et al., *Lateral development of electron showers measured by silicon*
24 *microstrip detectors*, *Nucl. Instr. and Meth.* **A388** (1997) 135 – 143.

SIMULATION, RECONSTRUCTION AND PHYSICS OBJECT PERFORMANCE

1 This chapter summarizes the expected performances of the CEPC baseline detector con-
2 cept based on Monte Carlo (MC) simulation studies. Section 10.1 describes software
3 and algorithm tools, event generation and simulation as well as the reconstruction. Sec-
4 tion 10.2 presents the performances for identifying and measuring basic physics objects
5 such as leptons, photons, jets and their flavors that form the building blocks of physics
6 analyses. The results presented represent the first attempt to understand the performance
7 of the CEPC baseline detector. They will likely improve with further studies and opti-
8 mization.

9 10.1 Event simulation and reconstruction

10 The simulation of physics events and detector responses and the reconstruction of the raw
11 detector information are vital for high energy physics experiments. Figure 10.1 shows the
12 flow chart of the event simulation and reconstruction. In this section, the functionalities
13 of key components of the chart are described.

14 10.1.1 Event simulation

15 For the studies of the CEPC physics performance, the Whizard [1] package is used as the
16 main event generator to produce physics events. Collaborating with the Whizard team,
17 a dedicated CEPC beam parametrization has been implemented in its official release.
18 The Whizard generator is used to simulate Standard Model processes, including both the
19 Higgs boson signal and all its SM background samples. Additionally, Madgraph [2] and
20 Pythia [3] generators are used to produce samples from beyond Standard Model physics.

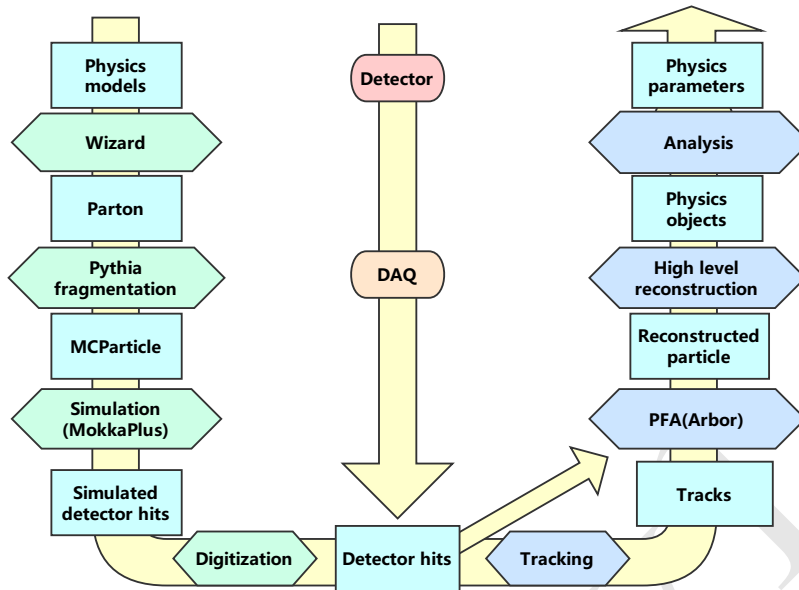

Figure 10.1: The flow chart of the CEPC simulation studies.

1 A GEANT4-based detector simulation framework, MokkaPlus, is used for the CEPC
 2 detector simulation. MokkaPlus is a virtual geometry constructor that compiles with the
 3 GEANT4 libraries [4] and a MySQL database [5]. It is an improved version of Mokka [6],
 4 a simulation framework used for early linear collider studies. The digitization of sim-
 5 ulated energy deposits in the detector are performed using a general algorithm that re-
 6 produces the test beam results [7] for the calorimeter and an `ilcsoft` scheme for the
 7 tracking detectors. The parameter values of the `ilcsoft` scheme are tuned to match the
 8 CEPC detector design. In addition, a fast simulation based on the efficiency and resolution
 9 parametrization derived from the full simulation was also developed. The fast simulation
 10 is used to produce most of the background samples for studies presented in this report.

11 10.1.2 Event reconstruction

12 The event reconstruction chain starts with the track reconstruction, followed by the par-
 13 ticle flow interpretation of tracks and calorimeter hits and finally the reconstruction of
 14 compound physics objects such as converted photons, K_S 's, τ -leptons and jets.

15 Tracks are reconstructed from hits in the tracking detectors by the tracking module.
 16 The module is currently based on the `Clupatra` module [8] of `ilcsoft` which has
 17 been shown to have excellent performance. A CEPC-specific tracking module with the
 18 flexibility of geometry modification is under development.

19 A dedicated particle flow reconstruction toolkit, ARBOR [9, 10], has been developed
 20 for the CEPC baseline detector concept. ARBOR is composed of a clustering module and
 21 a matching module. The clustering module reads the calorimeter hits and forms clusters
 22 of hits (also called branches) which are then arranged into a tree topology as illustrated in
 23 Figure 10.2 for the 3-prong decay of a τ -lepton. The matching module identifies calorime-

1 ter clusters with matching tracks and builds reconstructed charged particles. The remain-
 2 ing clusters are reconstructed into photons, neutral hadrons and unassociated fragments.
 3 From this unique list of particles, simple particles such as electrons, muons, photons,
 4 charged pions and kaons can then be identified.

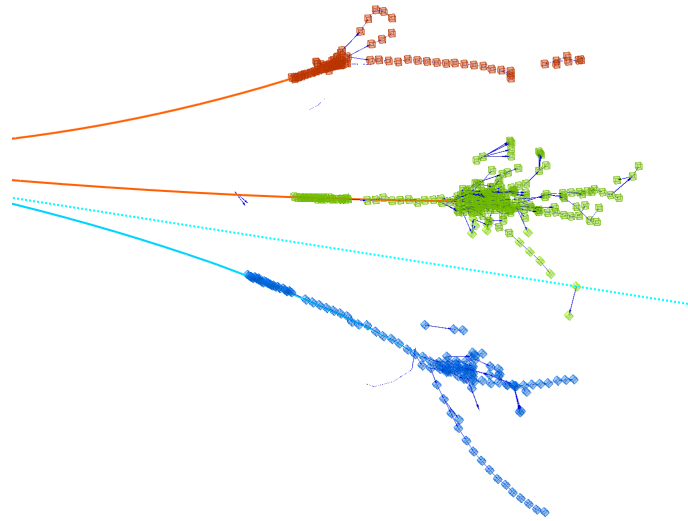

Figure 10.2: An illustration of particle flow reconstruction: the 3-prong decay of a τ -lepton from $Z \rightarrow \tau^+\tau^-$ reconstructed by the ARBOR algorithm. Three branches of calorimeter clusters correspond to the three reconstructed charged particles of the τ -lepton decay: a 5.7 GeV π^+ (red), a 27.4 GeV π^+ (green) and a 10.3 GeV π^- (blue). Also shown are lines representing Monte Carlo truth information: two π^+ 's (red), a π^- (cyan) and a $\bar{\nu}_\tau$ (cyan dashed).

5 The particle flow reconstruction provides a coherent interpretation of an entire physics
 6 event and, therefore, is well suited for the reconstruction of compound physics objects
 7 such as converted photons, K_S 's, τ -leptons and jets. The reconstruction of τ -leptons and
 8 jets are described in Section 10.2. CORAL, an algorithm that targets the reconstruction of
 9 converted photons, π^0 's and K_S 's, is being developed.

10 10.1.2.1 Track reconstruction

11 The CEPC baseline tracker consists of a silicon tracking system and a barrel TPC. The two
 12 subsystems play complementary roles. The silicon system provides high precision spatial
 13 point measurements whereas the TPC has more than 200 radial layers which significantly
 14 enhances the track finding performance of the detector. In addition, the silicon system
 15 includes a forward tracking system that extends the solid angle coverage of the tracker.

16 The performance of the CEPC tracker is studied using two samples: a single muon
 17 particle sample and an $e^+e^- \rightarrow Z \rightarrow \tau^+\tau^-$ sample at $\sqrt{s} = 91.2$ GeV. The single
 18 muon sample is used to characterize the tracking efficiency and momentum resolution for
 19 isolated tracks while the $Z \rightarrow \tau^+\tau^-$ sample, with the 3-prong decay for one of the two
 20 τ -leptons, provides a test for reconstructing closely spaced tracks.

21 The single muon sample covers a momentum range of 0.1 GeV to 100 GeV and the
 22 full angular range. Figure 10.3 shows the extracted efficiency and momentum resolution

as a function of the polar angle for different momentum bins. For muons in the tracking fiducial volume of $|\cos\theta| < 0.985$ and with momentum above 0.5 GeV, the reconstruction efficiency is nearly 100%. The momentum resolution reaches per mille level for the momentum range of 10–100 GeV in the barrel region. The resolution is limited by material-induced multiple scatterings at low momentum and by the magnetic field and level-arm at high momentum, consistent with the design goal outlined in Chapter 3. The τ -leptons from $Z \rightarrow \tau^+\tau^-$ are highly boosted and can lead to three closely spaced charged particles in their 3-prong decays, see Figure 10.2. For this sample, the efficiency for reconstructing all three tracks of the τ decays is found to be close to 100%.

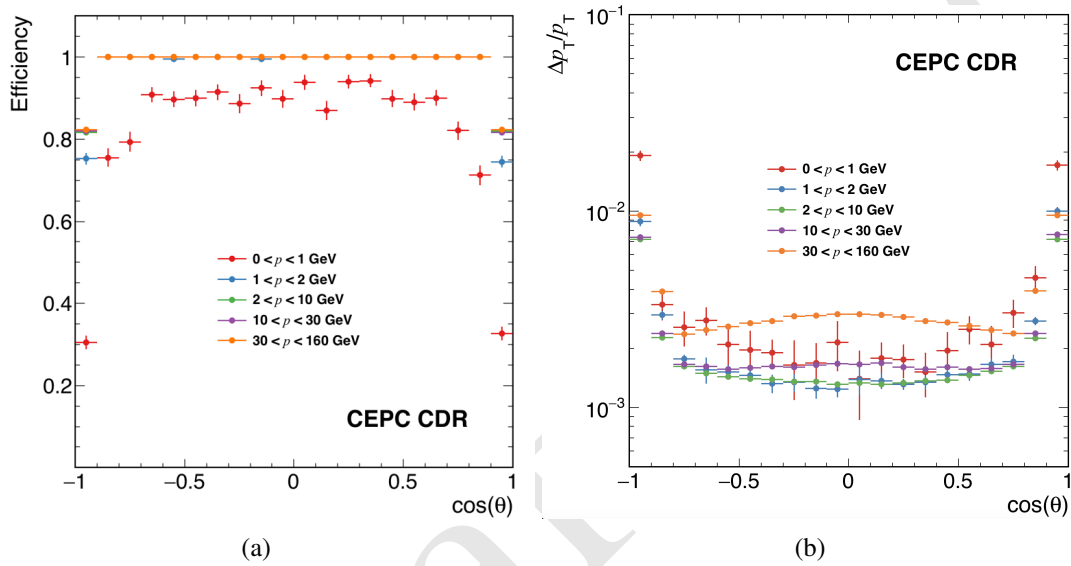

Figure 10.3: Single track reconstruction: (a) efficiency and (b) momentum resolution as a function of the cosine of the polar angle in different momentum bins.

10.1.2.2 Cluster reconstruction

The high-granularity calorimeters of the CEPC baseline detector concept are well suited for reconstructing clusters of energy deposits by traversing particles. The fine segmentation allows for the reconstruction of individual particles produced in shower cascades, see Figure 10.2.

Two relevant performance measures of the cluster reconstruction are the energy collection efficiency for single neutral particles and spatial separation capability for two closely spaced neutral particles. For photons with energy above 5 GeV, ARBOR is able to collect more than 99% of the energy deposited in the calorimeter while keeping the mis-clustering rate small. Good cluster spatial separation capability is essential for the reconstruction of compound particle objects such as π^0 's and τ -leptons. Figure 10.4(a) is a demonstration of the reconstructed clusters from two closely spaced photons from a π^0 decay. The efficiencies for successfully reconstructing two photon clusters as functions of their separation at the calorimeter entry points are shown in Figure 10.4(b) for three different ECAL cell sizes. The critical distance, defined as the minimum separation at which the efficiency for reconstructing two photon clusters is 50%, is found to be 16 mm for the baseline design of ECAL cell size of 10×10 mm². This corresponds to an average

- 1 efficiency of 50% for reconstructing two photons as two separate clusters from a 30 GeV
 2 π^0 decay with equal energy.

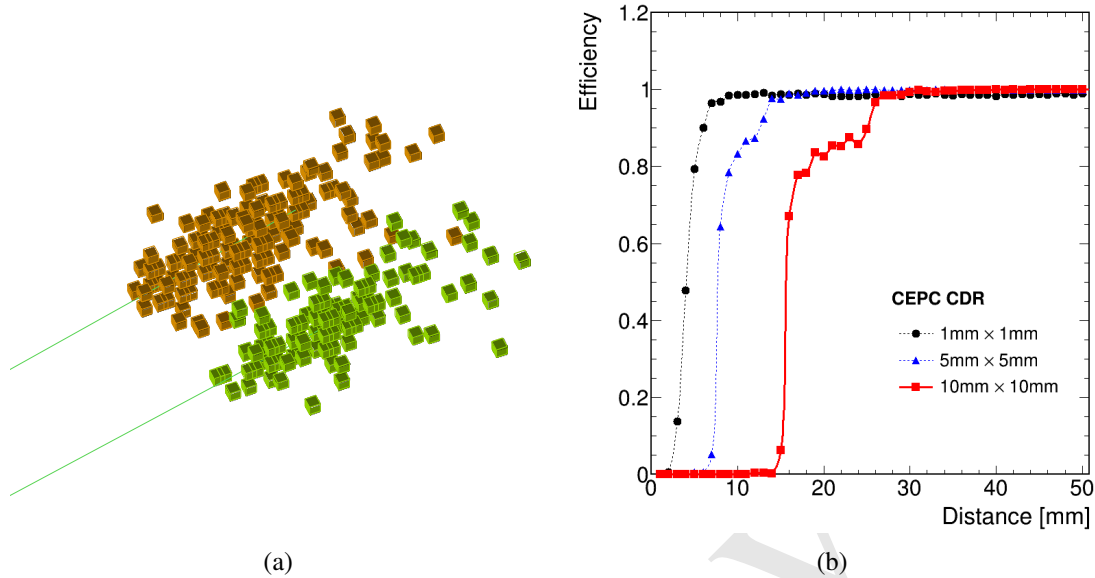

Figure 10.4: (a) Clusters of the two photons of energies of 6.2 GeV and 5.8 GeV from a 10 GeV π^0 decay reconstructed in the Silicon-Tungsten ECAL with a $10 \times 10 \text{ mm}^2$ cell size. (b) Reconstruction efficiencies of two photons as two separate clusters as functions of the distance between their calorimeter impact points for three different ECAL cell sizes. The ECAL cell size of the CEPC baseline detector is chosen to be $10 \times 10 \text{ mm}^2$. The secondary step structures in the efficiency curves reflect the finite granularity of the calorimeter.

3 10.2 Object Identifications and Performances

4 Particle flow reconstruction leads to a unique list of particles from which electrons, muons,
 5 photons, τ -leptons, and jets etc., the physics objects as they are customarily called, can
 6 be identified or built. These objects serve as building blocks for further physics analyses
 7 as presented in Chapter 11. In this section, their general identifications and the expected
 8 performances are described. For analyses of specific processes, the identifications and
 9 performances can often be improved by utilizing the unique topologies of the events under
 10 study.

11 10.2.1 Leptons

12 Leptons (ℓ , $\ell = e, \mu$)¹ are bedrocks to the CEPC physics program. $Z \rightarrow e^+e^-$ and
 13 $Z \rightarrow \mu^+\mu^-$ decays are indispensable for electroweak measurements and for the model-
 14 independent identification of the Higgs boson through the recoil mass method. A large
 15 fraction of Higgs bosons decay, directly or via cascade, into final states with electrons and
 16 muons.

17 The particle-flow oriented baseline detector, particularly its fine-segmented calorime-
 18 ter system, provides enormous information for the lepton identification. High energy

¹Unless otherwise noted, leptons refer to electrons, muons or their antiparticles.

1 electrons and hadrons will likely induce thousands of hits whereas muons deposit little
 2 energy in the calorimeter. Electrons can be identified from their pencil-like electromag-
 3 netic shower development in ECAL matched with tracks in the tracker. Muons exhibit
 4 themselves as minimum ionizing particles in the calorimeter matched with tracks in the
 5 tracker as well as in the muon system. Moreover, the dE/dx measurements in the TPC
 6 could provide additional discrimination of electrons from muons and hadrons for energies
 7 up to 10 GeV.

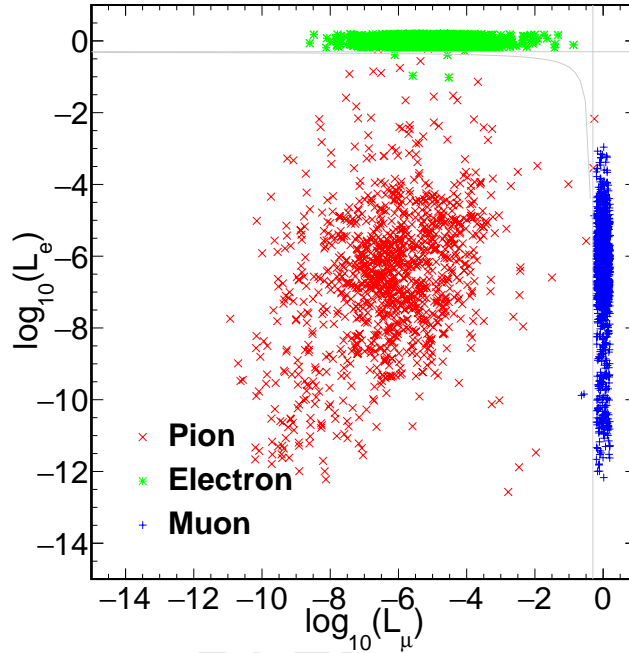

Figure 10.5: Distributions of the logarithm of e -likeliness L_e and μ -likeliness L_μ expected from 40 GeV electrons, muons and charged pions in the barrel calorimeter ($|\cos\theta| < 0.7$).

8 A lepton identification algorithm, LICH [11], has been developed and implemented
 9 in ARBOR. LICH combines more than 20 discriminating variables from the detector to
 10 build lepton-likelihoods, e -likeliness (L_e) and μ -likeliness (L_μ), using a multivariate tech-
 11 nique. Figure 10.5 compares the two-dimensional distributions of L_e and L_μ expected
 12 from single electrons, muons and charged pions, showing clear separations among these
 13 particles. For leptons above 2 GeV, an identification efficiency better than 99.5% and a
 14 mis-identification rate from hadrons smaller than 1% can be achieved. The main sources
 15 of mis-identifications are irreducible backgrounds from the $\pi^\pm \rightarrow \mu^\pm$ decays for muons
 16 and highly electromagnetic like π^\pm clusters (π^0 produced in pion-nucleon interactions)
 17 for electrons. The momentum resolution of the tracker (see Section 10.1.2.1) largely de-
 18 termines the resolutions for both electrons and muons. However, degradation of the reso-
 19 lutions is expected from Bremsstrahlung radiation, most importantly for electrons and to a
 20 lesser extent for muons. Recovering the radiation energy losses using the ECAL measure-
 21 ments should improve the resolutions. However, this is not implemented for the current
 22 studies.

23 For complex physics events, lepton identification will be affected by the limited spa-
 24 tial separation capability of the detector. For example, the efficiency for successfully
 25 identifying two leptons with opposite charges is found to be 97–98% for the $e^+e^- \rightarrow$

$ZH \rightarrow \ell^+ \ell^- H$ events. The small loss of the efficiency can be attributed to overlapping clusters in the calorimeter.

Figure 10.6 shows the reconstructed recoil mass² distributions of the $Z \rightarrow \mu^+ \mu^-$ and $Z \rightarrow e^+ e^-$ decays from the $e^+ e^- \rightarrow ZH$ process, and Figure 10.7 is the dimuon invariant mass distribution of $H \rightarrow \mu^+ \mu^-$ again from $e^+ e^- \rightarrow ZH$. The sharp peaks at the Higgs boson mass are demonstrations of excellent lepton energy/momentum and angular resolutions. The tails are due to radiation effects. The recoil mass distributions are critical for the model-independent identifications of the Higgs boson and a good dimuon mass resolution is essential for identifying $H \rightarrow \mu^+ \mu^-$ decays, see Section 11.1.

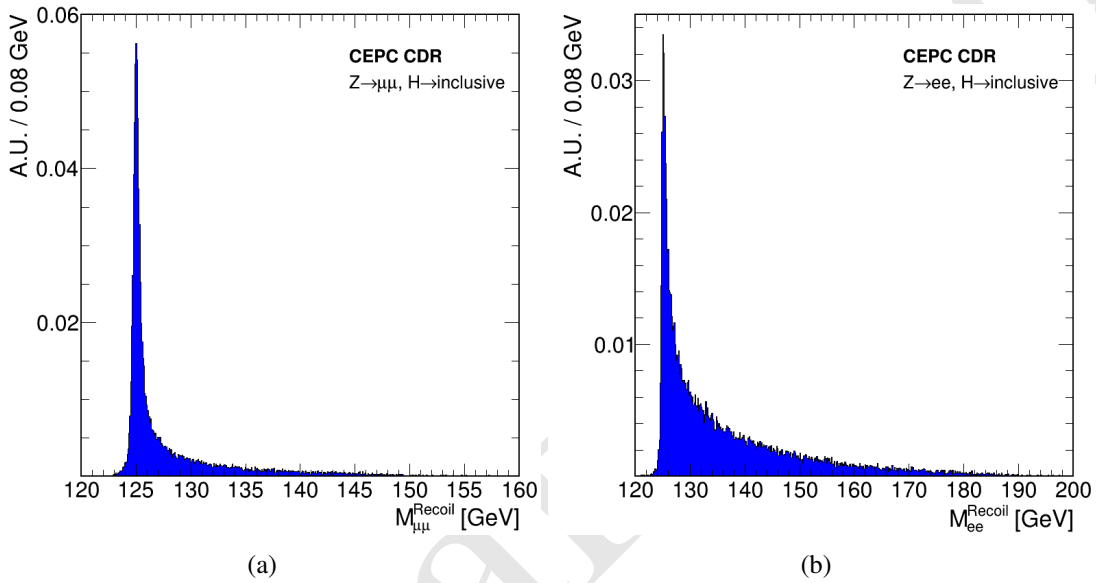

Figure 10.6: The reconstructed dilepton recoil mass distributions of $\mu^+ \mu^- H$ and $e^+ e^- H$ events, both normalized to unit area. The distributions peak strongly at the Higgs boson mass. The high-mass tails are results of radiation effects (for example the initial- and final-state radiations, the beamstrahlung and the Bremsstrahlung effects). Fit with double-sided crystal ball functions, each distribution exhibits a core width of 200–300 MeV. The $e^+ e^- H$ has a much more significant high mass tail, as the electrons have much stronger radiation effects compared to the muons.

10.2.2 Photons

Photons can be produced from either initial- and final-state radiation or decays of unstable particles. Precise photon measurements are essential, for example, for studying the $H \rightarrow \gamma\gamma$ decay and counting neutrino species. Moreover, photons are a large part of secondary particles that form jets and have an important role in the τ -lepton identification, they impact all aspects of the physics at the CEPC.

Photons have similar signatures as electrons in the calorimeter, but in general without matching tracks in the tracker. However, 5–10% of photons converts to $e^+ e^-$ pairs through their interaction with the materials in front of the calorimeter. Some of these converted photons will have reconstructed matching tracks. Figure 10.8(a) shows the material in the unit of radiation length, and Figure 10.8(b) is the photon conversion rate at different polar

²See Section 11.1.2 for the definition.

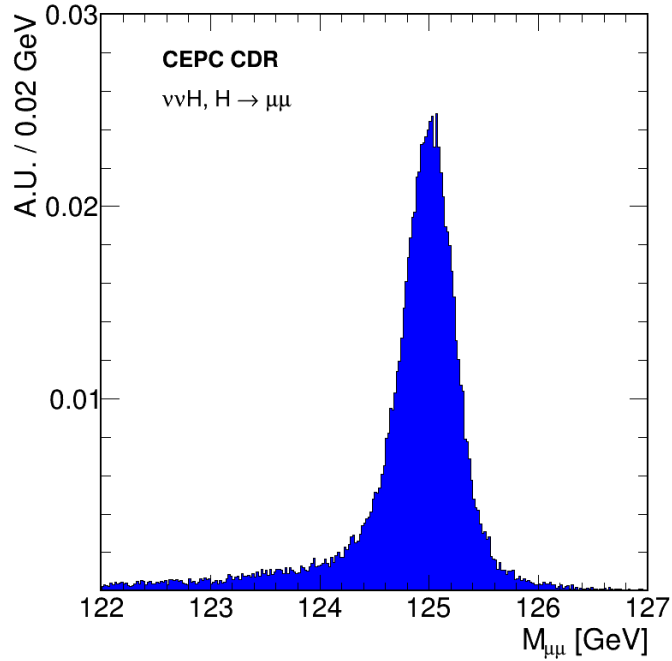

Figure 10.7: The reconstructed invariant mass distributions of dimuons from the $H \rightarrow \mu^+\mu^-$ decay produced in the $e^+e^- \rightarrow ZH$ process. The distribution shows a relative mass resolution of 0.19%.

1 angles. For unconverted photons of energies above 5 GeV, the identification efficiency is
 2 nearly 100% with more than 99% of their energy reconstructed. For the current studies,
 3 a simplistic algorithm has been used to identify converted photons. Approximately 80%
 4 of the converted photons are recovered using this algorithm. The rate of misidentifying a
 5 hadronic jet as a photon is found to be negligible.

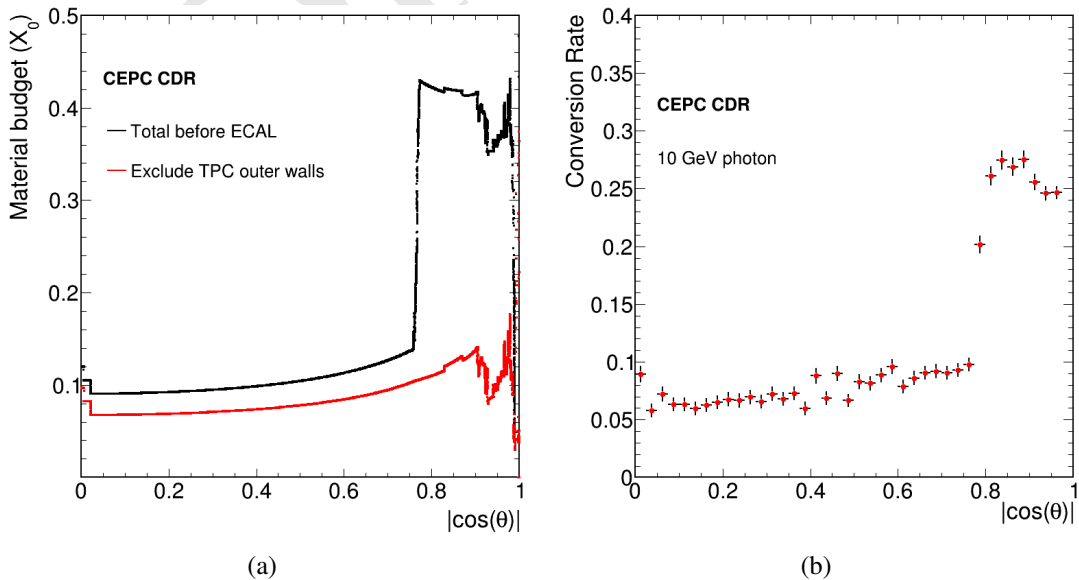

Figure 10.8: (a) The material in the unit of radiation length inside the tracker and (b) the conversion rate of 10 GeV photons for different polar angles.

Figure 10.9(a) compares the photon energy resolution of the baseline detector concept with the intrinsic resolution of the calorimeter. The intrinsic resolution is obtained from MC simulation without material in front and gaps between modules. To first order, the intrinsic resolution is consistent with the CALICE test beam result [12]. It represents the ultimate resolution of the detector. The material in the tracker and geometric inhomogeneities are the main causes for the degradation in the resolution of the baseline detector. These effects are currently not taken into account in the calibration. The resolution, both the sampling and constant terms, is expected to improve significantly once geometry dependent calibration is implemented. The photon energy resolution can be benchmarked using the diphoton mass distribution of the $H \rightarrow \gamma\gamma$ decay as shown in Figure 10.9(b). The width of the mass distribution is dominated by the energy resolution effect because of the narrow intrinsic Higgs boson width. The current diphoton mass resolution is approximately 2.5% compared with 1.7% of the intrinsic resolution.

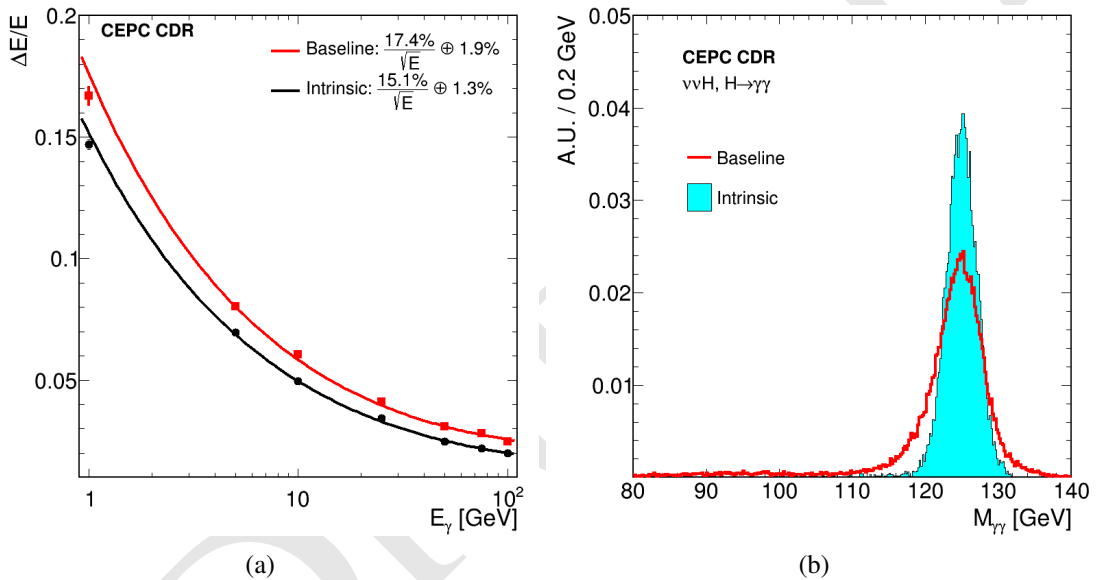

Figure 10.9: (a) Photon energy resolution as a function of its energy of the baseline detector compared to the intrinsic resolution of the calorimeter and (b) the invariant mass distribution of diphotons from the $H \rightarrow \gamma\gamma$ decay of the $e^+e^- \rightarrow ZH$ process. For the photon energy resolution, both detectors refers to single particle sample with flat θ distribution. In the baseline geometry, the events with converted photons are excluded. The resolution of the baseline detector is expected to improve with further optimizations and geometry-dependent calibrations which should bring it closer to the intrinsic resolution of the calorimeter.

10.2.3 Tau Leptons

As the heaviest lepton, τ -leptons have a unique role in studying Higgs boson physics. Leptonic decays of τ -leptons, $\tau \rightarrow e\nu\nu$ and $\tau \rightarrow \mu\nu\nu$, are indistinguishable from electrons or muons, displaced by the finite τ -lifetime. Hadronic decays of the τ -leptons appear in the detector as narrow pencil-shaped hadronic jets with low particle multiplicity. A basic τ -lepton identification algorithm has been developed for hadronic decays. The algorithm starts with a seed track with its energy above 1.5 GeV and clusters charged and neutral particles in a small cone of radius of 0.15 radians around it to form the τ -lepton candidate. The invariant mass formed by the particles in the cone is required to be in the range of

1 0.2–2 GeV, consistent with the τ -lepton mass. Furthermore, a discriminant variable based
 2 on the longitudinal and transverse impact parameters of the leading track is constructed
 3 and the variable is required to be consistent with the non-zero lifetime of the τ -lepton.
 4 Finally, the τ -lepton candidate is required to be isolated. The total energy in an annular
 5 cone or radius between 0.15–0.45 radians is required to be less than 8% of the τ -lepton
 6 candidate energy. The main backgrounds are hadronic jets.

7 Figure 10.10(a) is a graphic representation of the tau identification. The efficiency
 8 and the mis-identification rate as functions of the visible energy of the τ -lepton candidate
 9 are shown in Figure 10.10(b). The identification efficiency and mis-identification rate are
 10 currently optimized and characterized using the $e^+e^- \rightarrow ZH$ events with the $Z \rightarrow q\bar{q}$
 11 and $H \rightarrow \tau^+\tau^-$ decays. For visible energies above 50 GeV, the efficiency is closer to
 12 90% or higher with less than 1% mis-identification rate. The loss of efficiency is largely
 13 due to the large cone size used for the isolation requirement. Significant improvement in
 14 performance can be expected from dedicated optimization for τ -lepton identification.

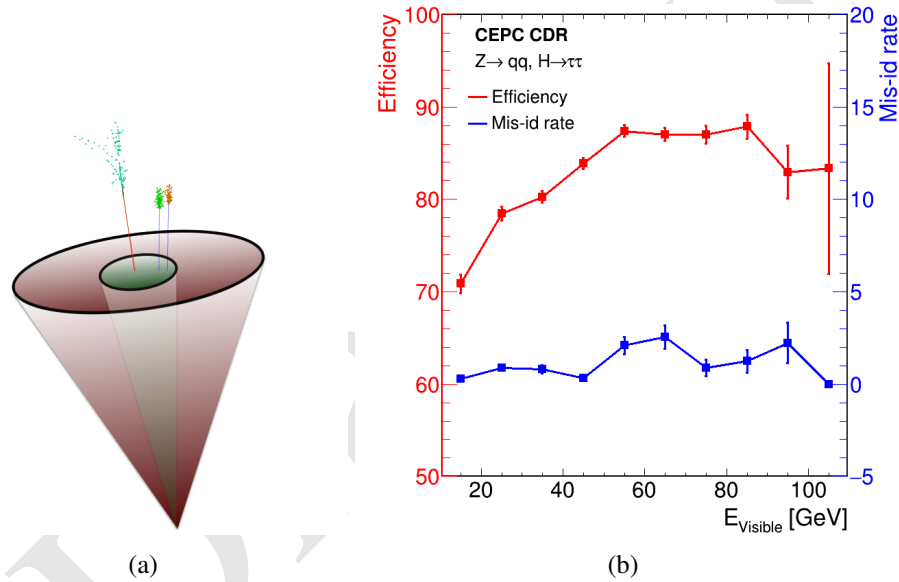

Figure 10.10: (a) Illustration of τ -lepton identification and (b) the efficiency and mis-identification rate as functions of the visible energy of τ -lepton candidate measured using $e^+e^- \rightarrow ZH$ events with the $Z \rightarrow q\bar{q}$ and $H \rightarrow \tau^+\tau^-$ decays for the signal efficiency, and the inclusive qqH events to estimate mis-identification rate, in the barrel region $|\cos(\theta)| < 0.6$.

15 10.2.4 Jets

16 The vast majority of the events produced at the CEPC have hadronic jets in their final
 17 states. For example, 70% of the Higgs bosons decay directly to a pair of jets and another
 18 20% decay indirectly to jets through intermediate W or Z bosons. Coincidentally, about
 19 70% of the W or Z bosons each decays to dijets. Thus the impact of jets to the CEPC
 20 physics program cannot be overstated.

21 Jets are formed from particles reconstructed by ARBOR using the Durham cluster-
 22 ing algorithm [13]. The ambiguity in clustering is the leading source of uncertainty in
 23 jet reconstruction and measurements, particularly in events with closely spaced physics
 24 objects.

1 Jet energies are foreseen to be calibrated through a two-step process. First, calibra-
 2 tions are applied to particles identified by ARBOR. While the energies of the charged parti-
 3 cles are determined by their track momenta, the energies of neutral particles are currently
 4 calibrated using MC simulation and can be calibrated using the test beam or collision data
 5 when they are available. Approximately 35% of the jet energy is carried by neutral parti-
 6 cles. In the second step, the jet energy are calibrated using physics events. At the CEPC,
 7 W and/or Z bosons are copiously produced and can be identified with high efficiency and
 8 purity. Thus $W \rightarrow q\bar{q}$ and $Z \rightarrow q\bar{q}$ decays serve as standard candles for the jet energy
 9 calibration. Clean samples of $WW \rightarrow \ell\nu q\bar{q}$ (ZH and WW runs), $ZZ \rightarrow \nu\bar{\nu}q\bar{q}$ (ZH run)
 10 and $Z \rightarrow q\bar{q}$ (Z pole run) can be selected. The enormous statistics allows the jet response
 11 to be characterized in detail.

12 Figure 10.11(a) shows energy ratios between the reconstructed jets and MC particle
 13 jets for different polar angles derived from simulated $ZZ \rightarrow \nu\bar{\nu}q\bar{q}$ events. The ratios
 14 are close to unity and thus the corrections are $< 1\%$. The jet energy resolution is shown
 15 in Figure 10.11(b) as a function of jet energy for different jet flavors. For light jets,
 16 the resolution ranges from 6% for at 20 GeV to 3.6% for at 100 GeV. The resolutions
 17 for heavy-flavor jets are poorer as expected because of neutrinos in their decays. Major
 18 factors affecting the jet energy scale and/or resolution are jet flavor composition, shower
 19 fluctuations, clustering algorithm as well as the stability and uniformity of the detector
 20 responses. Their impacts can be minimized by detailed studies and calibrations. A sub-
 21 percent level jet energy scale precision and a jet energy resolution of 3–5% for the jet
 22 energy range of 20–100 GeV should be achievable.

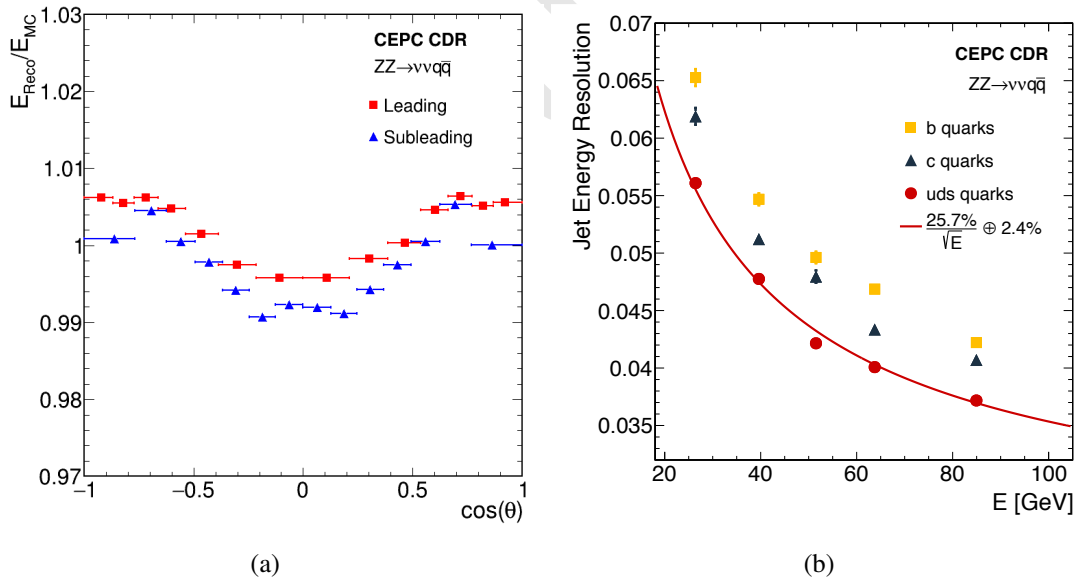

Figure 10.11: (a) The energy ratios between the reconstructed jets and MC particle jets as functions of cosine of their polar angles and (b) jet energy resolution as a function of its energy for different jet flavors. These distributions are derived from the simulated $ZZ \rightarrow \nu\bar{\nu}q\bar{q}$ events. The energy ratios are shown for leading and subleading jets separately.

23 One key jet performance measure is the ability to separate hadronic decays of W ,
 24 Z and Higgs bosons. Figure 10.12(a) compares the reconstructed dijet invariant mass
 25 distributions from $W \rightarrow q\bar{q}$, $Z \rightarrow q\bar{q}$ and $H \rightarrow b\bar{b}/c\bar{c}/gg$ decays of $WW \rightarrow \ell\nu q\bar{q}$,

$ZZ \rightarrow \nu\bar{\nu}q\bar{q}$ and $ZH \rightarrow \nu\bar{\nu}(b\bar{b}/c\bar{c}/gg)$ processes, respectively. Compared with $W \rightarrow q\bar{q}$, the $Z \rightarrow q\bar{q}$ and $H \rightarrow b\bar{b}/c\bar{c}/gg$ distributions have long low-mass tails. These tails are from the heavy-flavor jets as demonstrated in Figure 10.12(b) where the distributions from $H \rightarrow b\bar{b}$, $H \rightarrow c\bar{c}$ and $H \rightarrow gg$ decays are separately shown and compared. The $H \rightarrow gg$ distribution is symmetric and has the best mass resolution (at approximately 3.8%) whereas the $H \rightarrow b\bar{b}$ decay has a long asymmetric low-mass tail and therefore degraded mass resolution. The degradations in resolution and the distortions in the mass distributions for the $H \rightarrow b\bar{b}$ and $H \rightarrow c\bar{c}$ decay are expected from neutrinos produced in semi-leptonic decays of b - and c -quarks. The mass resolutions for $W \rightarrow q\bar{q}$ and $Z \rightarrow q\bar{q}$ are 4.4%, leading to an average separation better than 2σ for the hadronic decayed W and Z bosons.

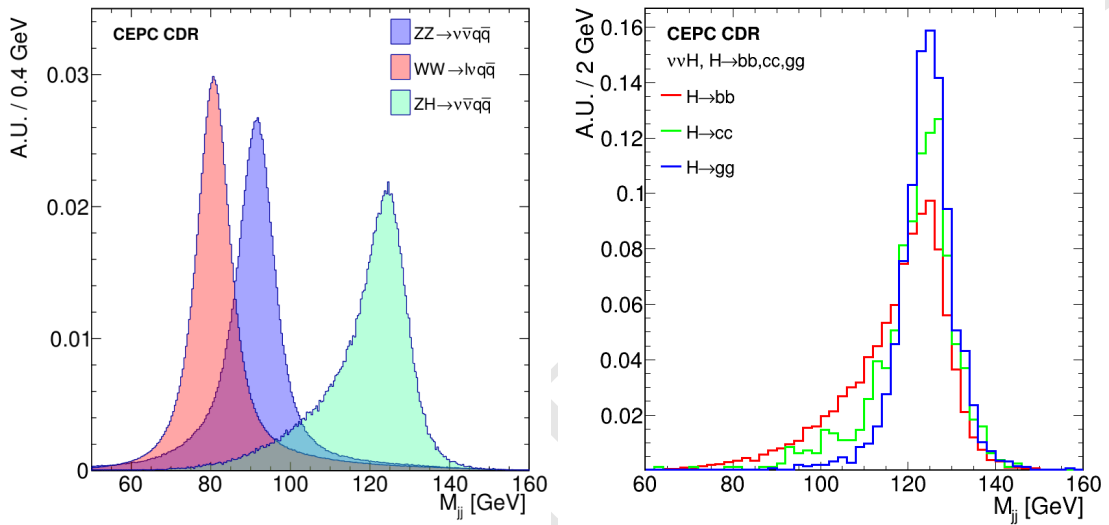

Figure 10.12: Reconstructed dijet mass distributions of (a) the $W \rightarrow q\bar{q}$, $Z \rightarrow q\bar{q}$ and $H \rightarrow b\bar{b}/c\bar{c}/gg$ decays from the $ZZ \rightarrow \nu\bar{\nu}q\bar{q}$, $WW \rightarrow \ell\nu q\bar{q}$ and $ZH \rightarrow \nu\bar{\nu}(b\bar{b}, c\bar{c}, gg)$ processes, respectively, and (b) the separate $H \rightarrow b\bar{b}$, $H \rightarrow c\bar{c}$ and $H \rightarrow gg$ decays from the $ZH \rightarrow \nu\bar{\nu}(b\bar{b}/c\bar{c}/gg)$ process. All distributions are normalized to unit area.

10.2.5 Jet flavor tagging

Identification, *i.e.* tagging, of jet flavors is essential for the measurements of the Higgs couplings and the electroweak observables at the CEPC. Heavy-flavor quarks (b and c) from W , Z or Higgs boson decays hadronize quickly to form heavy bottom and charm hadrons (B^0 , B^\pm , B_s , D^0 , D^\pm , ...). Those hadrons are short-lived and have typical decay distances of a few millimeters. Therefore, the reconstruction of their decay vertices, often referred as secondary vertices, is an important tool for tagging jet flavors. Other information such as jet and vertex mass, impact parameters and leptons inside the jets, are also frequently used to differentiate heavy-flavor jets from light-quark and gluon jets. For example, the excellent impact parameter resolution shown in Figure 4.2 can significantly improve the detector's capability for jet flavor tagging.

The jet flavor tagging is performed using LCFIPlus [14], the tagging algorithm used for linear collider studies. LCFIPlus reconstructs secondary vertices from the final-state particles identified by ARBOR. It combines more than 60 discriminant variables to cal-

1 culate the b -likeliness (L_B) and c -likeliness (L_C) using a Boosted Decision Tree [15]
 2 method. Compared with the b -jet tagging, c -jet tagging is particularly challenging as
 3 charm hadrons have shorter lifetimes than bottom hadrons and therefore suffers more
 4 from light-quark and gluon jet backgrounds. Benefiting from the high precision vertex
 5 system, the CEPC detector provides reasonable separation of c -jets from other flavor jets.
 6 Figure 10.13 shows the b -jet tagging efficiencies for different rejections of background
 7 jets, measured from a $Z \rightarrow q\bar{q}$ sample of the Z pole run. For this sample, b -jets can be
 8 tagged with an efficiency of 80% and a purity of 90%. Similarly, an efficiency of 60%
 9 and a purity of 60% can be achieved for the c -jet tagging. Purities can be improved by
 10 tightening the tagging requirements at the expense of reduced efficiencies. Figure 10.14
 11 is a demonstration of the b/c -likeliness distributions of the b , c and gluon jets from the
 12 $H \rightarrow b\bar{b}/c\bar{c}/gg$ decays, showing good separations between jets of different flavors.

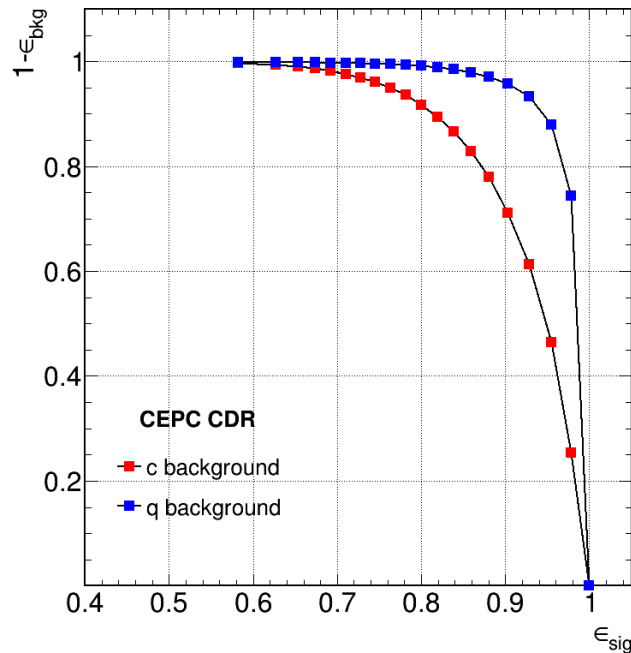

Figure 10.13: Efficiencies for tagging b -jets versus rejection of background jets, determined from an inclusive $Z \rightarrow q\bar{q}$ sample at the Z pole run.

13 10.2.6 Missing Energies, Momenta and Masses

14 Neutrinos interact weakly with the detector and for all practical purposes escape detection
 15 without traces. The same is true for the hypothesized dark matter particles. However,
 16 their existences can be inferred from detectable (“visible”) particles. The total energy and
 17 momentum of these “missing” particles, missing energy and momentum as they are usu-
 18 ally called, can be calculated from the energies and momenta of visible particles through
 19 energy-momentum conservation. Despite of their elusive nature, neutrinos are as impor-
 20 tant as visible particles for the CEPC physics program. About 20% of the Z bosons and
 21 30% of the W bosons decay directly into final states with neutrinos. Searching for Higgs
 22 boson decays to dark matter particles is a key physics goal of the Higgs factory.

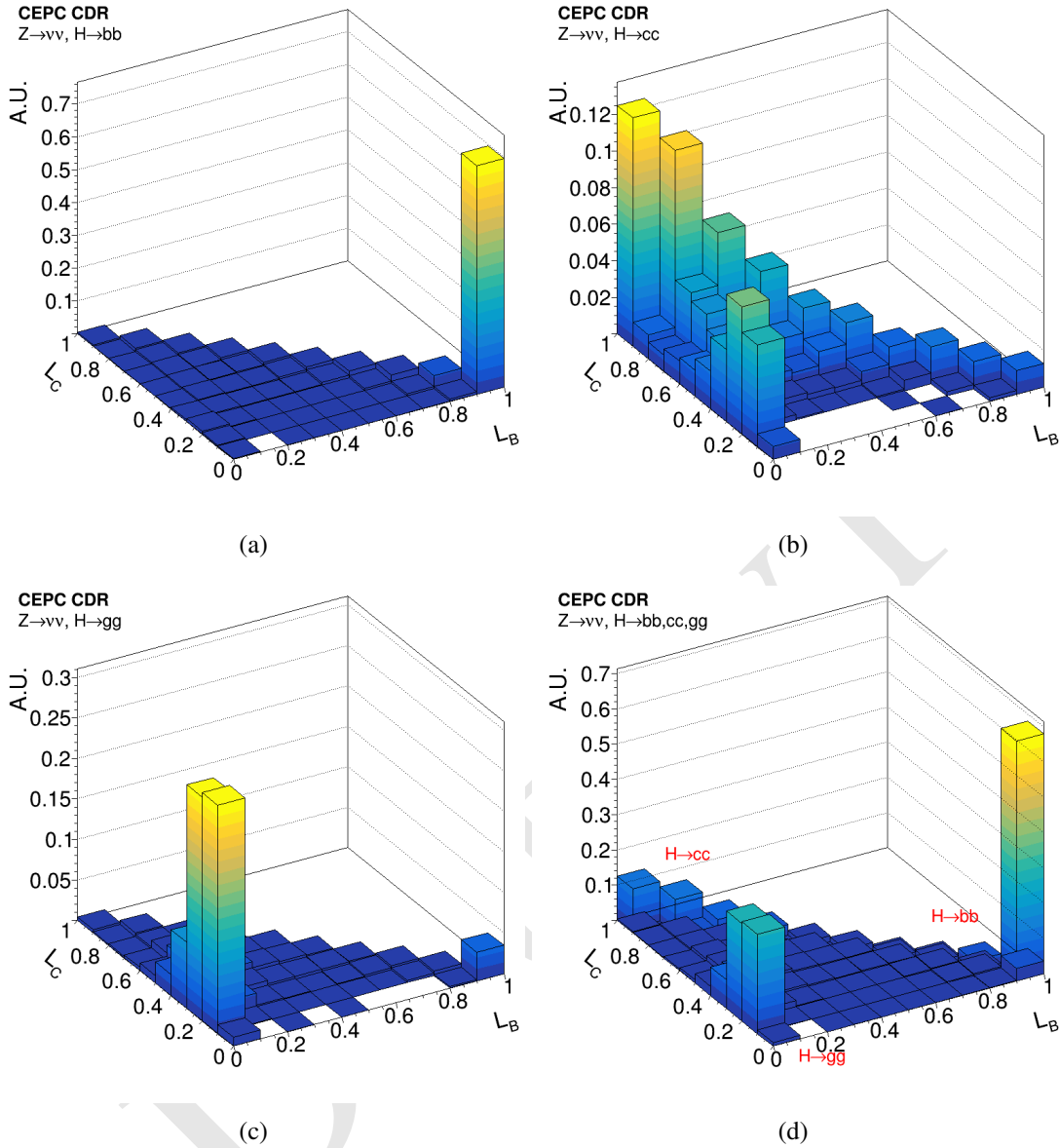

Figure 10.14: The two-dimensional distributions of b -likeliness L_B and c -likeliness L_C of jets from the $H \rightarrow b\bar{b}$, $H \rightarrow c\bar{c}$ and $H \rightarrow g\bar{g}$ decays showing separately (a,b,c) and combined (d). Distributions of individual decays (a,b,c) are normalized to unit volume while the combined distribution is the sum of the three individual distributions.

1 The excellent energy and momentum resolutions of the CEPC baseline conceptual
 2 detector for visible particles allow for the determinations of missing energy and momen-
 3 tum with good precision. This is demonstrated using $e^+e^- \rightarrow ZH$ events in Figure 10.15
 4 which shows the missing mass distributions of events from, respectively, ($Z \rightarrow q\bar{q}, H \rightarrow$
 5 inv) and ($Z \rightarrow \nu\bar{\nu}, H \rightarrow b\bar{b}/c\bar{c}/g\bar{g}$) decays. The missing mass, calculated from the miss-
 6 ing energy and momentum, is the invariant mass of the system of undetected particles. The
 7 missing mass distribution peaks at the Higgs boson mass for the $H \rightarrow \text{inv}$ decay and at the
 8 Z boson mass for the $Z \rightarrow \nu\bar{\nu}$ decay, as expected. Contributions from different jet flavors

- 1 are shown separately. The Higgs and Z boson masses can be determined from missing
 2 masses with good precision, allowing their identifications without direct detections.

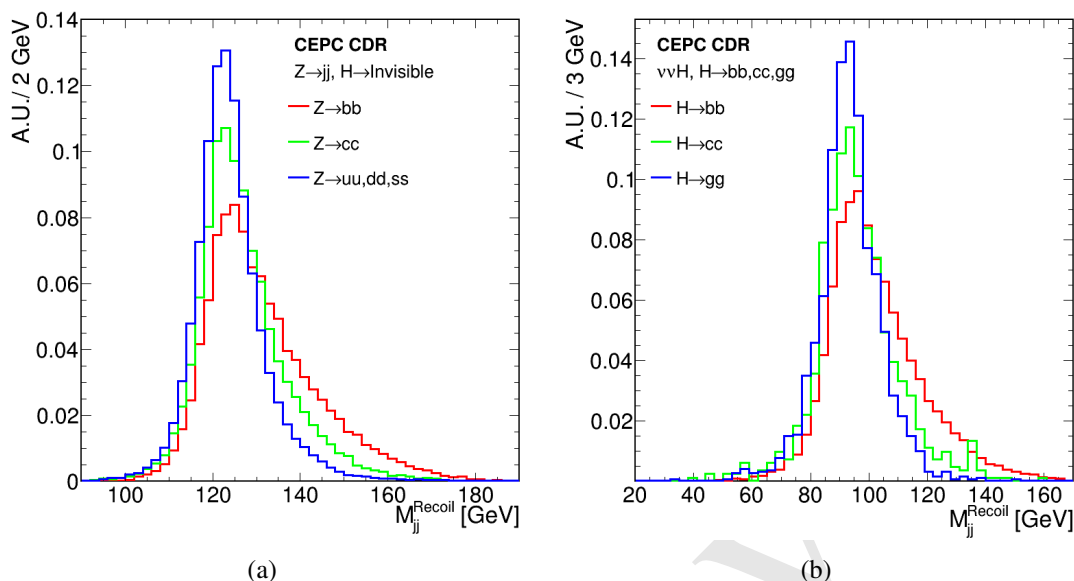

Figure 10.15: The dijet recoil mass (*i.e.*, the missing mass) distributions of $e^+e^- \rightarrow ZH$ events in the (a) $Z \rightarrow q\bar{q}$, $H \rightarrow \text{inv}$ and (b) $Z \rightarrow \nu\bar{\nu}$, $H \rightarrow b\bar{b}/c\bar{c}/gg$ decay, separately for different jet flavors. All distributions are normalized to unit area. The distributions of the light jets exhibit a width of $\sim 6\text{GeV}/8\text{GeV}$ for the left/right hand plot.

3 10.2.7 Kaon Identification

4 Successful identification of charged kaons will greatly benefit the flavor physics program
 5 and aid in the determination of jet flavor as well as jet charge. The dE/dx information
 6 from the TPC can be used to separate kaons from pions. Assuming a relative dE/dx
 7 resolution of 5%, the measurement could lead to $2\text{--}4\sigma$ separation of K/π for momentum
 8 between $2\text{--}20$ GeV as shown in Figure 10.16.

9 The discriminating power of dE/dx vanishes for pions and kaons with their mo-
 10 menta around 1 GeV. Meanwhile, a significant portion of the charged particles has an
 11 energy smaller than 2 GeV at the CEPC. To aid the separation of these low momentum
 12 charged particles, it has been proposed to add a Time of Flight (TOF) capability with a
 13 50 ps resolution to the detector design. The ECAL could be instrumented with a few layers
 14 of time sensitive readout to provide the TOF information. Using both the TOF and dE/dx
 15 information, a separation better than 2σ could be achieved for charged particles with mo-
 16 menta smaller than 20 GeV in the conservative scenario as shown in Figure 10.16(b). For
 17 the inclusive $Z \rightarrow q\bar{q}$ sample, charged kaons can be identified with an efficiency of 91%
 18 and a purity of 94%, integrated over the momentum range of $2\text{--}20$ GeV.

19 10.3 Summary

20 Precise measurements of the Higgs boson properties and the electroweak observables at
 21 the CEPC place stringent requirements on the performance of the CEPC detector to iden-

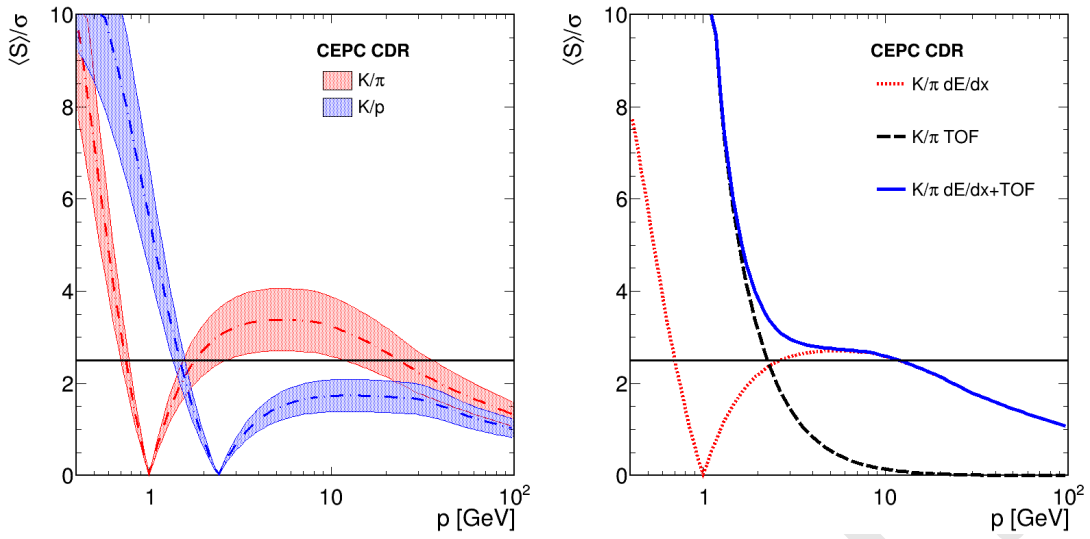

Figure 10.16: Charged particle identifications: (a) K/π and K/p separations from the dE/dx measurement in the TPC and (b) the K/π separation from both the dE/dx measurement and the proposed TOF information. The upper boundaries of the bands in (a) are the ideal separations predicted by the GEANT4 simulation while the lower boundaries correspond to conservative estimates with a 50% degradation in performance.

1 tify and measure physics objects such as leptons, photons, τ -leptons, jets and their flavors
 2 with high efficiencies and purities as well as high precision. The performances of the
 3 CEPC baseline detector have been investigated with full simulation. Benchmark perfor-
 4 mances are described above and are briefly summarized below:

- 5 1 Leptons: an efficiency of $> 99.5\%$ with a mis-identification rate of $< 1\%$ for electrons
 6 and muons with momenta above 2 GeV, a relative mass resolution of 0.19% for the
 7 $H \rightarrow \mu^+ \mu^-$ decay;
- 8 2 Photons: an efficiency of nearly 100% with negligible mis-identification rate from
 9 hadronic jets for photons above 5 GeV, relative mass resolution of 2.5% for the $H \rightarrow$
 10 $\gamma\gamma$ decay;
- 11 3 τ -leptons: an efficiency of 90% or higher with a mis-identification rate of $< 1\%$
 12 should be achievable for the identification of hadronic decays of τ -leptons from W ,
 13 Z or Higgs boson decays;
- 14 4 Jet energy scale and resolution: the jet energy scale can be measured with a sub-
 15 percent accuracy and a jet energy resolution of 3–5% is achievable for the energy
 16 range relevant at the CEPC, enabling an average 2σ separation of the $W \rightarrow q\bar{q}$ and
 17 $Z \rightarrow q\bar{q}$ decays;
- 18 5 Jet flavor tagging: efficiency/purity of 80%/90% for b -jets tagging and 60%/60% for
 19 c -jets tagging can be achieved for the $Z \rightarrow q\bar{q}$ sample of the Z pole run;
- 20 6 K^\pm identification: kaons can be separated from pions at 2σ for momentum up to
 21 20 GeV, corresponding to efficiency/purity of 95%/95% for identifying kaons in the
 22 $Z \rightarrow q\bar{q}$ sample integrated over the momentum range of 2–20 GeV.

23 Though significant progress has been made in understanding and characterizing the
 24 detector performance, the performance results can be further enhanced with improved

1 algorithms and better calibrations. Nevertheless, the performance results as currently un-
 2 derstood are sufficient to fulfill the requirements laid out in Chapter 3 and to meet the
 3 physics analysis needs as presented in Chapter 11.

4 References

- 5 [1] W. Kilian, T. Ohl, and J. Reuter, *WHIZARD—Simulating Multi-Particle Processes at*
 6 *LHC and ILC*, Eur. Phys. J. C **71** (2011) no. 9, 1742, [arXiv: 0708.4233](#)
 7 [\[hep-ph\]](#).
- 8 [2] J. Alwall et al., *The automated computation of tree-level and next-to-leading order*
 9 *differential cross sections, and their matching to parton shower simulations*, JHEP
 10 **07** (2014) 079, [arXiv: 1405.0301 \[hep-ph\]](#).
- 11 [3] The Pythia Group, *An Introduction to PYTHIA 8.2*, Comput. Phys. Commun. **191**
 12 (2015) 159, [arXiv:1410.3012 \[hep-ph\]](#).
- 13 [4] S. Agostinelli, J. Allison, K. a. Amako, J. Apostolakis, H. Araujo, P. Arce, M. Asai,
 14 D. Axen, S. Banerjee, G. . Barrand, et al., *Geant4 - a simulation toolkit*, Nucl. Instr.
 15 and Meth. A **506** (2003) no. 3, 250–303.
- 16 [5] *Mysql*, <https://www.mysql.com/>.
- 17 [6] P. M. de Freitas and H. Videau, *Detector simulation with Mokka/Geant4: Present*
 18 *and future*, LC-TOOL-2003-010 .
- 19 [7] Y. Haddad et al., *Software digitizer for high granular gaseous detector*, [arXiv:](#)
 20 [1405.1286 \[physics.ins-det\]](#).
- 21 [8] F. Gaede, S. Aplin, R. Glattauer, C. Rosemann, and G. Voutsinas, *Track*
 22 *reconstruction at the ILC: the ILD tracking software*, *J. Phys. Conf. Ser.* **513** (2014)
 23 [022011](#).
- 24 [9] M. Ruan, *Arbor - a new approach of the Particle Flow Algorithm*,
 25 [arXiv:1403.4784 \[physics.ins-det\]](#).
- 26 [10] M. Ruan et al., *Reconstruction of physics objects at the Circular Electron Positron*
 27 *Collider*, Eur. Phys. J. C **78** (2018) .
- 28 [11] D. Yu et al., *Lepton identification at Particle Flow oriented detector for the future*
 29 *e^+e^- Higgs factories*, Eur. Phys. J. C **77** (2017) , [arXiv: 1701.07542](#)
 30 [\[physics.ins-det\]](#).
- 31 [12] F. Sefkow, A. White, K. Kawagoe, R. Pöschl, and J. Repond, *Experimental Tests of*
 32 *Particle Flow Calorimetry*, *Rev. Mod. Phys.* **88** (2016) 015003,
 33 [arXiv:1507.05893 \[physics.ins-det\]](#).
- 34 [13] S. Catani, Y. L. Dokshitzer, M. Olsson, G. Turnock, and B. R. Webber, *New*
 35 *clustering algorithm for multi - jet cross-sections in $e^+ e^-$ annihilation*, *Phys. Lett.*
 36 **B269** (1991) 432–438.
- 37 [14] T. Suehara and T. Tanabe, *LCFIPlus: A Framework for Jet Analysis in Linear*
 38 *Collider Studies*, [arXiv: 1506.08371 \[physics.ins-det\]](#).

- ¹ [15] J. Therhaag, *TMVA Toolkit for multivariate data analysis in ROOT*, PoS
² **ICHEP2010** (2010) 510.

Draft-V1.0

PHYSICS PERFORMANCE WITH BENCHMARK PROCESSES

1 The historic discovery of a Higgs boson in 2012 by the ATLAS and CMS collabora-
2 tions [1, 2] and the subsequent studies of the properties of the particle [3–9] indicate com-
3 patibility with the Standard Model (SM) predictions at the current measurement precision.
4 The Higgs boson appears to complete all of the particles needed to describe the SM. This
5 possibility creates an inexplicable foundation for the SM theory, one that is elusive as to
6 the origin and stability of the vast difference between the Planck and electroweak (EW)
7 scales, the nature of the electroweak phase transition, whether the Higgs boson couples
8 to dark matter, and other fundamental questions that remain to be understood. The at-
9 tempt to further address those questions will involve new physics beyond the SM which
10 could lead to deviations from SM expectations when tested with precision measurements.
11 A circular electron positron collider will provide an unique opportunity to have precise
12 measurements of the Higgs, W and Z properties.

13 The CEPC produces a huge statistics of massive SM bosons. Its physics potential
14 is explored on two different classes of physics benchmarks, Higgs physics and precision
15 EW physics. Using the software tools introduced in Section 10.1, the physics potential on
16 Higgs physics is analyzed at full simulation level, see Section 11.1. The accuracies on the
17 EW precision measurements are mainly limited by systematic errors and are estimated in
18 Section 11.2. The synergies of these different physics measurements, the complementarity
19 and comparison to the HL-LHC and other high energy physics programs are discussed in
20 Chapter 12.

11.1 Higgs Boson Physics

The Higgs boson is responsible for the electroweak symmetry breaking. It is the only fundamental scalar particle in the Standard Model observed so far. The discovery of such a particle at the LHC is a major breakthrough on both theoretical and experimental fronts. However, the Standard Model is likely only an effective theory at the electroweak scale. To explore potential new physics at the electroweak scale and beyond, complementary approaches of direct searches at the energy frontier as well as precision measurements will be needed. The current LHC and the planned HL-LHC have the potential to significantly extend its new physics reach and to measure many of the Higgs boson couplings with precision of a few percents model-dependently.

At the CEPC, in contrast to the LHC, Higgs boson candidate events can be identified through a technique known as the recoil mass method without tagging its decays. Therefore, Higgs boson production can be disentangled from its decay in a model independent way. Moreover, the cleaner environment at a lepton collider allows much better exclusive measurement of Higgs boson decay channels. All of these give the CEPC impressive reach in probing Higgs boson properties. In this section, the results of the current CEPC simulation studies on the precision of the Higgs boson property measurements are summarized. In addition, potential reaches in the CP admixture of the Higgs boson are also estimated. More details can be found in Ref. [10].

11.1.1 Higgs boson production and decay

Production processes for a 125 GeV SM Higgs boson at the CEPC are $e^+e^- \rightarrow ZH$ (ZH or Higgsstrahlung), $e^+e^- \rightarrow \nu_e\bar{\nu}_eH$ ($\nu\bar{\nu}H$ or W fusion) and $e^+e^- \rightarrow e^+e^-H$ (eeH or Z fusion) as illustrated in Figure 11.1. The W and Z fusion processes are collectively referred to as vector-boson fusion (VBF) production.

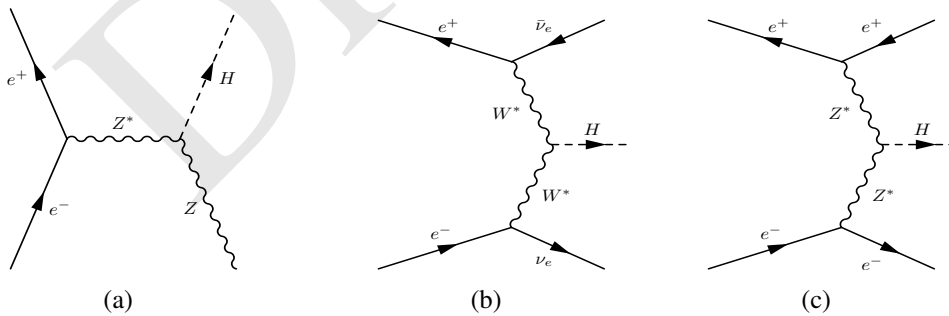

Figure 11.1: Feynman diagrams of the Higgs boson production processes at the CEPC: (a) $e^+e^- \rightarrow ZH$, (b) $e^+e^- \rightarrow \nu_e\bar{\nu}_eH$ and (c) $e^+e^- \rightarrow e^+e^-H$.

The total and individual cross sections for the production of a SM Higgs boson with a mass of 125 GeV as functions of center-of-mass energy are plotted in Figure 11.2 while its decay branching ratios and total width are shown in Table 11.1. As an s -channel process, the cross section of the $e^+e^- \rightarrow ZH$ process reaches its maximum at $\sqrt{s} \sim 250$ GeV, and then decreases asymptotically as $1/s$. The VBF production processes are through t -channel exchanges of vector bosons. Their cross sections increase logarithmically as

$\ln^2(s/M_V^2)$. Because of the accidental small neutral-current Zee coupling, the VBF cross section is dominated by the W fusion process.

Numerical values of these cross sections at $\sqrt{s} = 240$ GeV are listed in Table 11.2¹. Because of the interference effects between $e^+e^- \rightarrow ZH$ and $e^+e^- \rightarrow \nu_e\bar{\nu}_eH$ for the $Z \rightarrow \nu_e\bar{\nu}_e$ decay and between $e^+e^- \rightarrow ZH$ and $e^+e^- \rightarrow e^+e^-H$ for the $Z \rightarrow e^+e^-$ decay, the cross sections of these processes cannot be separated. The breakdowns in Figure 11.2 and Table 11.2 are for illustration only. The $e^+e^- \rightarrow ZH$ cross section shown is from Figure 11.1(a) only whereas the $e^+e^- \rightarrow \nu_e\bar{\nu}_eH$ and $e^+e^- \rightarrow e^+e^-H$ cross sections include contributions from their interference with the $e^+e^- \rightarrow ZH$ process.

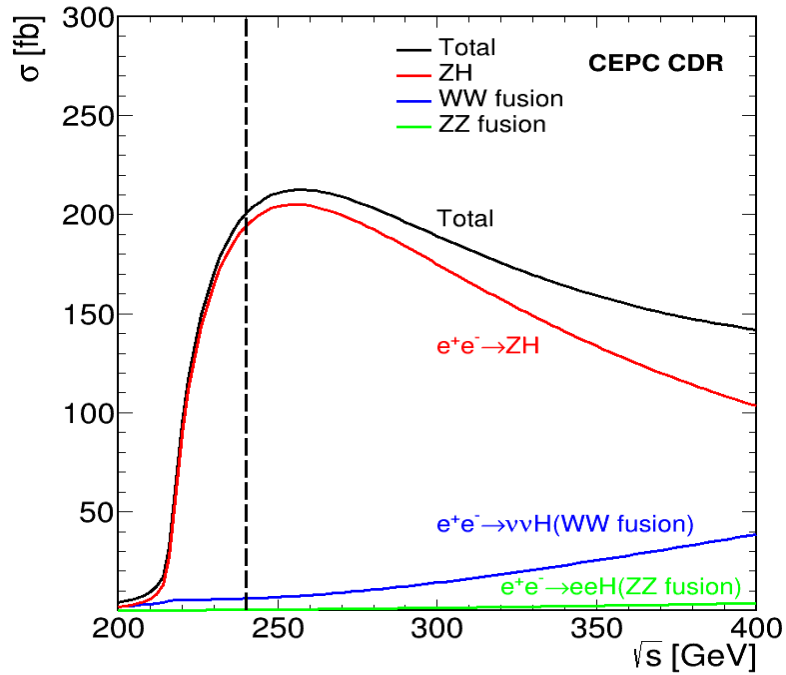

Figure 11.2: Production cross sections of $e^+e^- \rightarrow ZH$ and $e^+e^- \rightarrow (e^+e^-/\nu\bar{\nu})H$ as functions of \sqrt{s} for a 125 GeV SM Higgs boson. The vertical dashed line indicates $\sqrt{s} = 240$ GeV, the nominal energy of the CEPC Higgs factory.

The CEPC as a Higgs factory is designed to deliver a total of 5.6 ab^{-1} integrated luminosity to two detectors in 7 years. Over 10^6 Higgs boson events will be produced during this period. The large statistics, well-defined event kinematics and clean collision environment will enable the CEPC to measure Higgs boson production cross sections as well as its properties (mass, decay width and branching ratios, etc.) with precision far beyond those achievable at the LHC. Compared with hadron collisions, e^+e^- collisions are unaffected by underlying event and pile-up effects. Theoretical calculations are less dependent on higher order QCD radiative corrections. Therefore, more precise tests of theoretical predictions can be performed at the CEPC. The tagging of $e^+e^- \rightarrow ZH$ events using the invariant mass of the system recoiling against the Z boson, independent of the Higgs boson decay, is unique to lepton colliders. It provides a powerful tool for the model-independent measurements of the inclusive $e^+e^- \rightarrow ZH$ production cross section,

¹Note that the QED ISR correction for the $e^+e^- \rightarrow ZH$ channel produces a lowering of the cross section of about 20% at the nominal energy of 240 GeV.

Decay mode	Branching ratio	Relative uncertainties
$H \rightarrow b\bar{b}$	57.7%	+3.2%, -3.3%
$H \rightarrow c\bar{c}$	2.91%	+12%, -12%
$H \rightarrow \tau^+\tau^-$	6.32%	+5.7%, -5.7%
$H \rightarrow \mu^+\mu^-$	2.19×10^{-4}	+6.0%, -5.9%
$H \rightarrow WW^*$	21.5%	+4.3%, -4.2%
$H \rightarrow ZZ^*$	2.64%	+4.3%, -4.2%
$H \rightarrow \gamma\gamma$	2.28×10^{-3}	+5.0%, -4.9%
$H \rightarrow Z\gamma$	1.53×10^{-3}	+9.0%, -8.8%
$H \rightarrow \gamma\gamma$	8.57%	+10%, -10%
Γ_H	4.07 MeV	+4.0%, -4.0%

Table 11.1: Standard model predictions of the decay branching ratios and total width of a 125 GeV Higgs boson. These numbers are obtained from Refs. [11, 12].

$\sigma(ZH)$, and of Higgs boson decay branching ratios. Combinations of these measurements will enable to determine the total Higgs boson decay width and to extract the Higgs boson couplings to fermions and vector bosons, providing sensitive probes to potential new physics beyond the SM.

SM background processes include $e^+e^- \rightarrow e^+e^-$ (Bhabha), $e^+e^- \rightarrow Z\gamma$ (Z radiative return), $e^+e^- \rightarrow WW/ZZ$ (diboson) as well as the single boson production of $e^+e^- \rightarrow e^+e^-Z$ and $e^+e^- \rightarrow e^+\nu W^-/e^-\bar{\nu}W^+$. Their cross sections and expected numbers of events for an integrated luminosity of 5.6 ab^{-1} at $\sqrt{s} = 240 \text{ GeV}$ are shown in Table 11.2 as well. The energy dependence of the cross sections for these and the Higgs boson production processes are shown Figure 3.1. Note that many of these processes can lead to identical final states and thus can interfere. For example, $e^+e^- \rightarrow e^+\nu_e W^- \rightarrow e^+\nu_e e^-\bar{\nu}_e$ and $e^+e^- \rightarrow e^+e^-Z \rightarrow e^+e^-\nu_e\bar{\nu}_e$ have the same final state. Unless otherwise noted, these processes are simulated together to take into account interference effects for the studies presented in this report. Similar to the Higgs boson processes, the breakdowns shown in the table and figure are for illustration only.

11.1.2 Higgs boson tagging

Perhaps the most striking difference between hadron-hadron and e^+e^- collisions is that electron and positron are fundamental particle whereas hadrons are composite particles. Consequently the energy of e^+e^- collisions is known. Therefore through the energy and momentum conservation, the energy and momentum of a Higgs boson can be inferred from other particles in an event without examining the Higgs boson itself. For a Higgsstrahlung event where the Z boson decays to a pair of visible fermions (ff), the mass of the system recoiling against the Z boson, commonly known as the recoil mass, can be calculated assuming the event has a total energy \sqrt{s} and zero total momentum:

$$M_{\text{recoil}}^2 = (\sqrt{s} - E_{ff})^2 - p_{ff}^2 = s - 2E_{ff}\sqrt{s} + m_{ff}^2. \quad (11.1)$$

Process	Cross section	Events in 5.6 ab^{-1}
Higgs boson production, cross section in fb		
$e^+e^- \rightarrow ZH$	196.2	1.10×10^6
$e^+e^- \rightarrow \nu_e \bar{\nu}_e H$	6.19	3.47×10^4
$e^+e^- \rightarrow e^+e^- H$	0.28	1.57×10^3
Total	203.7	1.14×10^6
Background processes, cross section in pb		
$e^+e^- \rightarrow e^+e^-$ (Bhabha)	24.7	1.4×10^8
$e^+e^- \rightarrow q\bar{q}(\gamma)$	54.1	3.0×10^8
$e^+e^- \rightarrow \mu^+\mu^-(\gamma)$ [or $\tau^+\tau^-(\gamma)$]	5.3	3.0×10^7
$e^+e^- \rightarrow WW$	16.7	9.4×10^7
$e^+e^- \rightarrow ZZ$	1.1	6.2×10^6
$e^+e^- \rightarrow e^+e^- Z$	4.54	2.5×10^7
$e^+e^- \rightarrow e^+\nu W^- / e^-\bar{\nu}W^+$	4.09	2.3×10^7

Table 11.2: Cross sections of Higgs boson production and other SM processes at $\sqrt{s} = 240 \text{ GeV}$ and numbers of events expected in 5.6 ab^{-1} . The cross sections are calculated using the Whizard program [13]. Note that there are interferences between the same final states from different processes after the W or Z boson decays. Their treatments are explained in the text.

1 Here E_{ff} , p_{ff} and m_{ff} are, respectively, the total energy, momentum and invariant mass
2 of the fermion pair. The M_{recoil} distribution should show a peak at the Higgs boson mass
3 m_H for $e^+e^- \rightarrow ZH \rightarrow ffH$ and $e^+e^- \rightarrow e^+e^-H$ processes, and is expected to be
4 smooth without a resonance structure for background processes in the mass region around
5 125 GeV. Two important measurements of the Higgs boson can be performed from the
6 M_{recoil} mass spectrum. The Higgs boson mass can be determined from the position of
7 the resonance in the spectrum. The width of the resonance structure is dominated by
8 the beam energy spread (including ISR effects) and energy/momentum resolution of the
9 detector as the natural Higgs boson width is only 4.07 MeV. The best precision of the mass
10 measurement can be achieved from the leptonic $Z \rightarrow \ell\ell$ ($\ell = e, \mu$) decays. The height of
11 the resonance is a measure of the Higgs boson production cross section $\sigma(ZH)^2$. Through
12 a fit to the M_{recoil} spectrum, the $e^+e^- \rightarrow ZH$ event yield, and therefore $\sigma(ZH)$, can be
13 extracted, independent of Higgs boson decays. Higgs boson decay branching ratios can
14 then be determined by measuring the ZH cross sections of individual Higgs boson decay
15 modes. The recoil mass spectrum has been investigated for both leptonic and hadronic Z
16 boson decays as presented below.

17 The leptonic Z decay is ideal for studying the recoil mass spectrum of the $e^+e^- \rightarrow$
18 ZX events. The decay is easily identifiable and the lepton momenta can be precisely
19 measured. Figure 11.3 shows the reconstructed recoil mass spectra of $e^+e^- \rightarrow ZX$ can-
20 didates for the $Z \rightarrow \mu^+\mu^-$ and $Z \rightarrow e^+e^-$ decay modes. The analyses are based on

²For the $Z \rightarrow e^+e^-$ decay, there will be a small contribution from $e^+e^- \rightarrow e^+e^-H$ production.

1 the full detector simulation for the signal events and on the fast detector simulation for
 2 background events. The event selections are entirely based on the information of the
 3 two leptons, independent of the final states of Higgs boson decays. This approach is es-
 4 sential for the measurement of the inclusive $e^+e^- \rightarrow ZH$ production cross section and
 5 the model-independent determination of the Higgs boson branching ratios. SM processes
 6 with at least 2 leptons in their final states are considered as backgrounds. As shown in Fig-
 7 ure 11.3, the analysis has a good signal-to-background ratio. The long high-mass tail is
 8 largely due to the initial-state radiation. Leading background contributions after the selec-
 9 tion are from ZZ , WW and $Z\gamma$ events. Compared to the $Z \rightarrow \mu^+\mu^-$ decay, the analysis
 10 of the $Z \rightarrow e^+e^-$ decay suffers from additional and large background contributions from
 11 Bhabha and single boson production.

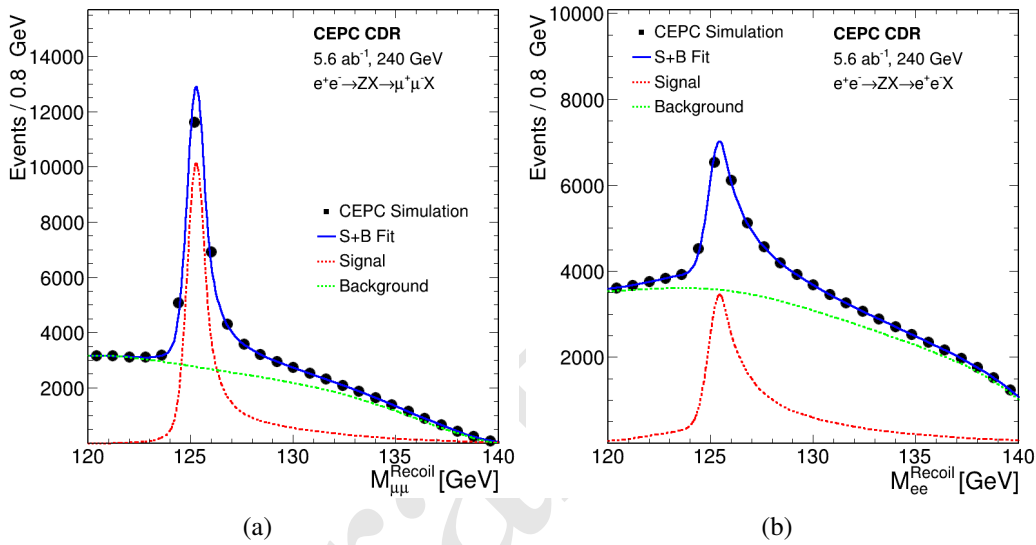

Figure 11.3: The inclusive recoil mass spectra of $e^+e^- \rightarrow ZX$ candidates of (a) $Z \rightarrow \mu^+\mu^-$ and (b) $Z \rightarrow e^+e^-$. No attempt to identify X is made. The markers and their uncertainties represent expectations from a CEPC dataset of 5.6 ab^{-1} whereas the solid blue curves are the signal-plus-background fit results. The dashed curves are the signal and background components.

12 The recoil mass technique can also be applied to the hadronic Z boson decays
 13 ($Z \rightarrow q\bar{q}$) of the $e^+e^- \rightarrow ZX$ candidates. This analysis benefits from a larger $Z \rightarrow q\bar{q}$
 14 decay branching ratio, but suffers from worse jet energy resolution compared with the
 15 track momentum and electromagnetic energy resolutions. In addition, ambiguity in se-
 16 lecting jets from the $Z \rightarrow q\bar{q}$ decay, particularly in events with hadronic decays of the
 17 Higgs boson, can degrade the analysis performance and also introduce model depen-
 18 dences. Therefore, the measurement is highly dependent on the detector performance
 19 and the jet clustering algorithm. Following the same approach as the ILC study [14], an
 20 analysis based on the fast simulation has been performed. After the event selection, main
 21 backgrounds arise from $Z\gamma$'s and WW production.

22 11.1.3 Measurements of $\sigma(ZH)$ and m_H

23 The inclusive $e^+e^- \rightarrow ZH$ production cross section $\sigma(ZH)$ and Higgs boson mass
 24 m_H can be extracted from fits to the recoil mass distributions of the $e^+e^- \rightarrow ZX \rightarrow$

$(\ell^+\ell^-/q\bar{q})X$ candidates. For the leptonic $Z \rightarrow \ell\ell$ decays, the recoil mass distribution of the signal process $e^+e^- \rightarrow ZH$ (and also $e^+e^- \rightarrow e^+e^-H$ in case of the $Z \rightarrow e^+e^-$ decay) is modeled with a Crystal Ball function [15] whereas the total background is modeled with a polynomial function in the fit. As noted above, the recoil mass distribution is insensitive to the intrinsic Higgs boson width if it were as small as predicted by the SM. The Higgs boson mass can be determined with precision of 6.5 MeV and 14 MeV from the $Z \rightarrow \mu^+\mu^-$ and $Z \rightarrow e^+e^-$ decay modes, respectively. In combination, an uncertainty of 5.9 MeV can be achieved. $e^+e^- \rightarrow ZX \rightarrow q\bar{q}X$ events contribute little to the precision of the m_H measurement due to the poor $Z \rightarrow q\bar{q}$ mass resolution, but dominates the precision of the $e^+e^- \rightarrow ZH$ cross section measurement benefiting from its large statistics. A relative precision of 0.65% on $\sigma(ZH)$ is predicted from a simple event counting analysis. In comparison, the corresponding precision from the $Z \rightarrow e^+e^-$ and $Z \rightarrow \mu^+\mu^-$ decays is estimated to be 1.5% and 0.9%, respectively. The combined precision of the three measurements is 0.5%.

For the model-independent measurement of $\sigma(ZH)$, event selections independent of the Higgs boson decays are essential. However, additional selections using the Higgs boson decay information can be applied to improve the Higgs boson mass measurement. This will be particularly effective in suppressing the large backgrounds in the $Z \rightarrow e^+e^-$ and $Z \rightarrow q\bar{q}$ decay modes. This improvement is not implemented in the current study.

11.1.4 Analyses of individual Higgs boson decay modes

Different decay modes of the Higgs boson can be identified through their unique signatures, enabling the measurements of production rates for these decays. Simulation studies of the CEPC baseline conceptual detector have been performed for the Higgs boson decay modes of $H \rightarrow b\bar{b}/c\bar{c}/gg$, $H \rightarrow WW^*$, $H \rightarrow ZZ^*$, $H \rightarrow \gamma\gamma$, $H \rightarrow Z\gamma$, $H \rightarrow \tau^+\tau^-$, $H \rightarrow \mu^+\mu^-$ and $H \rightarrow \text{inv.}$ The large numbers of the decay modes of the H , W and Z boson as well as the τ -lepton lead to a very rich variety of event topologies. This complexity makes it impractical to investigate the full list of final states descending from the Higgs boson decays. Instead, a limited number of final states of individual Higgs boson decay mode has been considered. In most cases, the dominant backgrounds come from SM diboson production and Z production with initial or final state radiations.

The studies are optimized for the dominant ZH process, however the $e^+e^- \rightarrow \nu_e\bar{\nu}_eH$ and $e^+e^- \rightarrow e^+e^-H$ processes are included whenever applicable. The production cross sections of individual decay mode, $\sigma(ZH) \times \text{BR}$, are extracted. Combined with the inclusive $\sigma(ZH)$ measurement, these measurements will permit the determinations of the Higgs boson decay branching ratios in a model-independent way. Main features of these studies are described below and their results are presented in Section 11.1.5.

For a SM Higgs boson with a mass of 125 GeV, nearly 70% of all Higgs bosons decay into a pair of jets: b -quarks (57.7%), c -quarks (2.9%) and gluons (8.6%). While the $H \rightarrow b\bar{b}$ decay has been observed at the LHC, the $H \rightarrow c\bar{c}$ and $H \rightarrow gg$ decays are difficult, if not impossible, to be conclusively identified even at the HL-LHC due to large backgrounds. In comparison, these three decays can be isolated and studied at the CEPC in detail. This is important as the $H \rightarrow c\bar{c}$ decay is likely the only vehicle for investigating the Higgs boson couplings to the second-generation quarks. The study considers all Z boson decay modes except $Z \rightarrow \tau^+\tau^-$. The $H \rightarrow b\bar{b}/c\bar{c}/gg$ candidates are identified through the dijet invariant mass, or the recoil mass of the visible Z boson decays, or

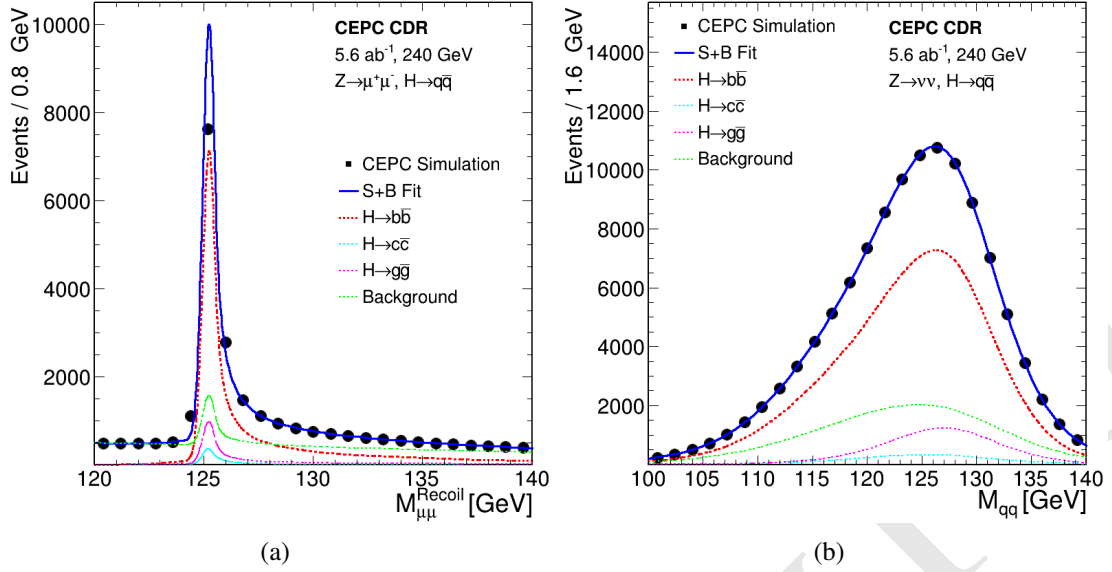

Figure 11.4: (a) $e^+e^- \rightarrow ZH$ production with $H \rightarrow b\bar{b}/c\bar{c}/g\bar{g}$: distributions of (a) the recoil mass of $Z \rightarrow \mu^+\mu^-$ and (b) the dijet invariant mass distribution for the $Z \rightarrow \nu\bar{\nu}$ decay. The markers and their uncertainties represent expectations from a CEPC dataset of 5.6 ab^{-1} whereas the solid blue curves are the signal-plus-background fit results. The dashed curves are the signal and background components. Contributions from other Higgs boson decays are included in the background.

both. Jet flavor tagging is employed to statistically separate $H \rightarrow b\bar{b}, c\bar{c}, g\bar{g}$ contributions. Figure 11.4(a) shows the reconstructed recoil mass distribution of the $Z \rightarrow \mu^+\mu^-$ decay. Compared with the distribution of inclusive Higgs boson decays shown in Figure 11.3(a), the background is significantly reduced through the identification of specific Higgs boson decay modes. Figure 11.4(b) is the dijet mass distribution of the $Z \rightarrow \nu\bar{\nu}$ decay, showing excellent signal-to-background ratio and good dijet mass resolution.

The W -fusion $e^+e^- \rightarrow \nu_e\bar{\nu}_e H$ process has a cross section of 3.2% of that of the ZH process at $\sqrt{s} = 240 \text{ GeV}$ in the SM. This process has been explored with the $H \rightarrow b\bar{b}$ decay mode. The analysis suffers from large backgrounds from $ZH \rightarrow \nu\bar{\nu}b\bar{b}$ as it has the same signature. However, the $\nu\bar{\nu}H$ and $Z(\nu\bar{\nu})H$ contributions can be separated through the exploration of their kinematic differences. Higgs bosons are produced with different polar angular distributions. Moreover, the recoil mass distribution of the $b\bar{b}$ system should exhibit a resonance structure at the Z boson mass for $Z(\nu\bar{\nu})H$ and show a continuum spectrum for $e^+e^- \rightarrow \nu_e\bar{\nu}_e H$. The $\nu\bar{\nu}H$ contribution is extracted through a fit to the two-dimensional distribution of the cosine of the polar angle and the recoil mass of the $b\bar{b}$ system.

The $H \rightarrow WW^*$ and $H \rightarrow ZZ^*$ decays are among the first decay modes studied at the LHC and are critical for the discovery of the Higgs boson thanks to the clean leptonic signatures of the W and Z boson decays. However due to their large backgrounds, hadronic final states of the $H \rightarrow WW^*$ and $H \rightarrow ZZ^*$ decays are out of reach at the LHC despite of their larger branching ratios than leptonic final states. This is not the case at the CEPC. In fact, most of the sensitivities to these two Higgs boson decay modes at the CEPC are expected to be from final states with one or both vector bosons decay hadronically. A number of selected final states have been studied. For $H \rightarrow WW^*$, the final states

1 included are $Z \rightarrow \ell\ell$, $H \rightarrow WW^* \rightarrow \ell\nu\ell\nu, \ell\nu q\bar{q}$; $Z \rightarrow \nu\bar{\nu}$, $H \rightarrow WW^* \rightarrow \ell\nu\ell\nu, q\bar{q}q\bar{q}$
 2 and $Z \rightarrow q\bar{q}$, $H \rightarrow WW^* \rightarrow q\bar{q}q\bar{q}$. For $H \rightarrow ZZ^*$, they are $Z \rightarrow \mu^+\mu^-$, $H \rightarrow ZZ^* \rightarrow$
 3 $\nu\bar{\nu}q\bar{q}$ and $Z \rightarrow \nu\bar{\nu}$, $H \rightarrow ZZ^* \rightarrow \ell\ell q\bar{q}$. A combination of the recoil mass, the invariant
 4 mass of the $W \rightarrow q\bar{q}$ and $Z \rightarrow q\bar{q}$ decay as well as the leptonic decay signatures of W and
 5 Z bosons are used to identify ZH events. Some of these analyses suffer from large back-
 6 grounds as shown, for example, in Figure 11.5(a), while others are almost background
 7 free as illustrated in Figure 11.5(b).

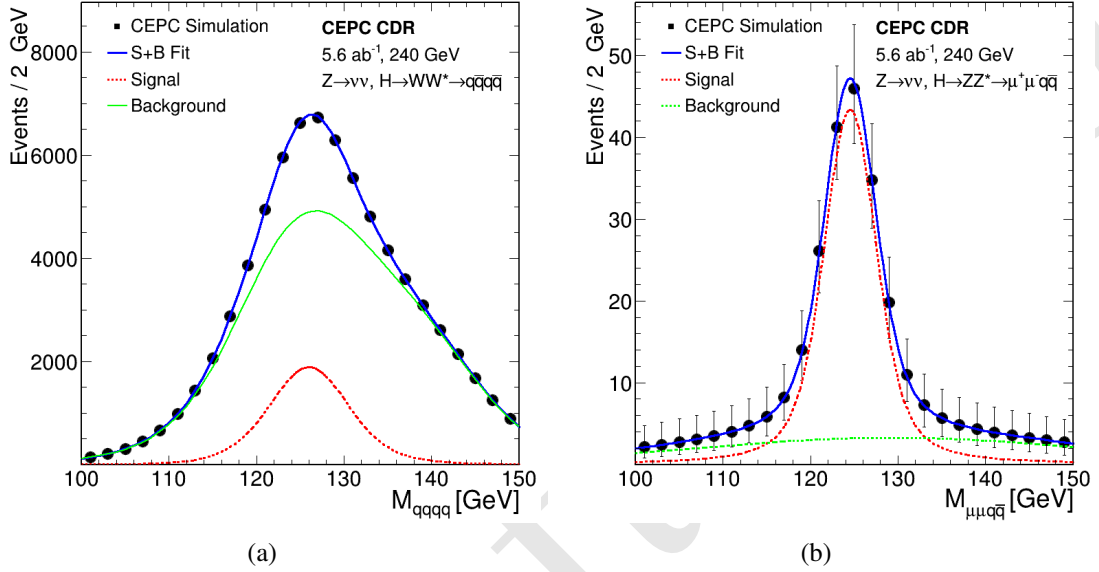

Figure 11.5: (a) $e^+e^- \rightarrow ZH$ production with $H \rightarrow WW^* \rightarrow q\bar{q}q\bar{q}$ and $Z \rightarrow \nu\bar{\nu}$: the invariant mass of the 4-jet system. (b) $e^+e^- \rightarrow ZH$ production with $H \rightarrow ZZ^* \rightarrow \mu^+\mu^-q\bar{q}$ and $Z \rightarrow \nu\bar{\nu}$: the invariant mass distribution of the dimuon and dijet system. The markers and their uncertainties represent expectations from a CEPC dataset of 5.6 ab^{-1} whereas the solid blue curves are the signal-plus-background fit results. The dashed curves are the signal and background components. Contributions from other Higgs boson decays are included in the background.

8 The $H \rightarrow \gamma\gamma$ and $H \rightarrow Z\gamma$ decays have small branching ratios in the SM as they
 9 proceed through W boson and top quark triangular loops. CEPC's sensitivities to these
 10 two decay modes have been examined. The $H \rightarrow \gamma\gamma$ analysis of ZH production suffers
 11 from large $e^+e^- \rightarrow (Z/\gamma^*)\gamma\gamma$ background where γ 's arise from the initial and final state
 12 radiations. All Z boson decay modes other than the $Z \rightarrow e^+e^-$ decay are considered
 13 for the $H \rightarrow \gamma\gamma$ studies. The ZH production with $Z \rightarrow e^+e^-$ has additional large
 14 backgrounds from the Bhabha process. As shown in Figure 11.6(a), the $H \rightarrow \gamma\gamma$ signal
 15 is expected to appear as a resonance over a smooth background in the diphoton mass
 16 distribution. ZH production with $H \rightarrow Z\gamma$ decay will lead to events with two on-shell
 17 Z bosons and one photon. The $H \rightarrow Z\gamma$ study targeted the signal process of $ZH \rightarrow$
 18 $ZZ\gamma \rightarrow \nu\bar{\nu}q\bar{q}\gamma$. In this final state, the energy and momentum of the $\nu\bar{\nu}$ system can
 19 be calculated from the visible energy and momentum of the event. The mass difference
 20 between the Higgs boson candidate and the candidate of the associated Z boson can then
 21 be calculated. For signal events, this mass difference is expected to be $m_H - m_Z \sim$
 22 35 GeV for correct combinations as shown in Figure 11.7(b). For background events and
 23 wrong combinations of signal events, the distribution should be smooth.

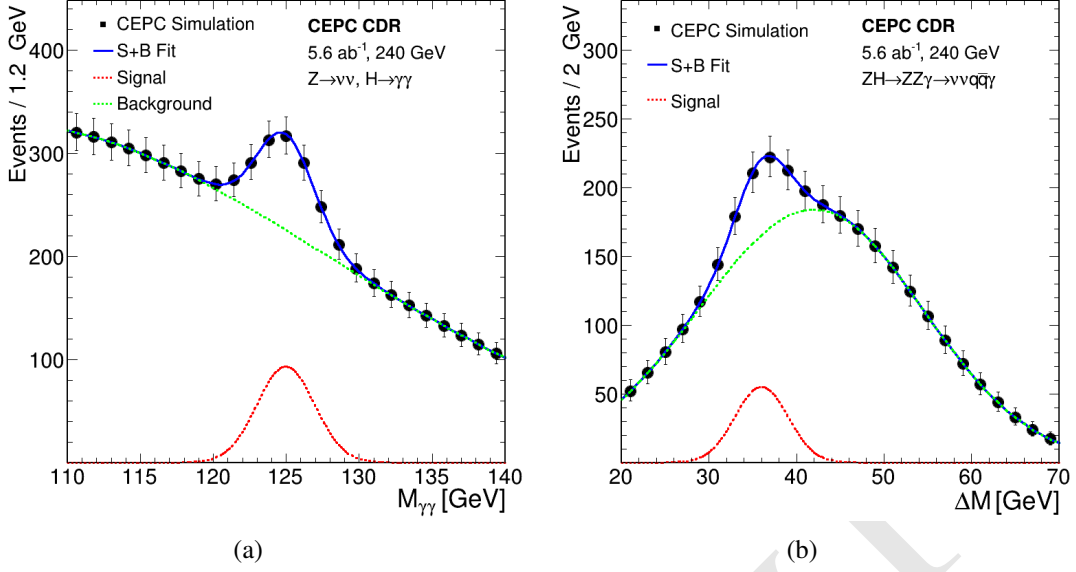

Figure 11.6: (a) $e^+e^- \rightarrow ZH$ production with $H \rightarrow \gamma\gamma$: the invariant mass distribution of the selected photon pairs for $Z \rightarrow \nu\bar{\nu}$. (b) $e^+e^- \rightarrow ZH$ production with $H \rightarrow Z\gamma$: the distribution of the mass difference between the reconstructed $Z\gamma$ and Z system. The markers and their uncertainties represent expectations from a CEPC dataset of 5.6 ab^{-1} whereas the solid blue curves are the signal-plus-background fit results. The dashed curves are the signal and background components.

1 Leptonic Higgs boson decays are accessible for $H \rightarrow \tau^+\tau^-$ and $H \rightarrow \mu^+\mu^-$ at
 2 the CEPC. Simulation studies of ZH production with the $H \rightarrow \tau^+\tau^-$ decay have been
 3 performed for all Z boson decay modes except $Z \rightarrow e^+e^-$. A boosted decision tree uti-
 4 lizing particle multiplicity and their separations is used to select di-tau candidates from
 5 $H \rightarrow \tau^+\tau^-$. An impact-parameter based variable of the leading track of the di-tau candi-
 6 date is used as the final discriminant for the signal extraction. An example distribution of
 7 this variable for $Z \rightarrow \nu\bar{\nu}$ is shown Figure 11.7(a). Similar to $H \rightarrow \gamma\gamma$, the $H \rightarrow \mu^+\mu^-$
 8 decay also allows the reconstruction of the Higgs boson with high resolution. The signal
 9 is expected to appear as a resonance structure at m_H over the smooth background in the
 10 dimuon mass spectrum. Good dimuon mass resolution is essential for the performance.
 11 For this study, all Z boson decay modes are considered. Figure 11.7(b) shows the dimuon
 12 mass distribution combining all Z boson decay modes.

13 In the SM, the Higgs boson can decay invisibly via $H \rightarrow ZZ^* \rightarrow \nu\bar{\nu}\nu\bar{\nu}$ with a
 14 branching ratio of 1.06×10^{-3} . In many extensions to the SM, the Higgs boson can decay
 15 directly to invisible particles with a significantly higher branching ratio. At the CEPC, the
 16 invisible decay of the Higgs boson ($H \rightarrow \text{inv}$) can be directly identified using the recoil
 17 mass information of the Z boson decays. The sensitivity to ZH production with $H \rightarrow \text{inv}$
 18 is estimated for $Z \rightarrow \ell\ell$ and $Z \rightarrow q\bar{q}$ decays. The SM $H \rightarrow ZZ^* \rightarrow \nu\bar{\nu}\nu\bar{\nu}$ decay is used
 19 to model the $H \rightarrow \text{inv}$ decay in both the SM and its extension. This is made possible by
 20 the fact that the Higgs boson is narrow scalar in the SM so that the production and decay
 21 are factorized. The upper limit on the BSM contribution to $\text{BR}(H \rightarrow \text{inv})$, $\text{BR}_{\text{inv}}^{\text{BSM}}$, can
 22 then be estimated.

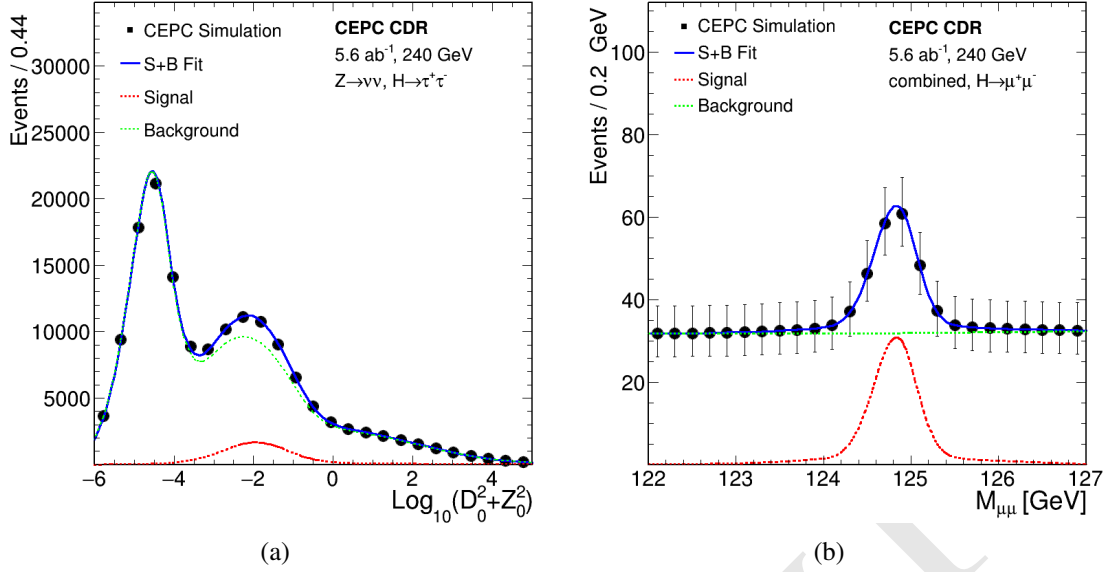

Figure 11.7: (a) $e^+e^- \rightarrow ZH$ production with $H \rightarrow \tau^+\tau^-$: the distribution of impact parameter variable of the leading track of the di-tau candidates for the $Z \rightarrow \nu\bar{\nu}$ decay mode. Contributions from other Higgs boson decays are included in the background. (b) $e^+e^- \rightarrow ZH$ production with $H \rightarrow \mu^+\mu^-$: the invariant mass distribution of the selected muon pairs combining all Z boson decay modes. The markers and their uncertainties represent expectations from a CEPC dataset of 5.6 ab^{-1} whereas the solid blue curves are the signal-plus-background fit results. The dashed curves are the signal and background components.

11.1.5 Combination of individual analyses

With the measurements of inclusive cross section $\sigma(ZH)$ and the cross sections of individual Higgs boson decay mode $\sigma(ZH) \times \text{BR}$, the Higgs boson decay branching ratio, BR, can be extracted. Most of the systematic uncertainties associated with the measurement of $\sigma(ZH)$ cancels in this procedure. A maximum likelihood fit is used to estimate the precision on BRs. For a given Higgs boson decay mode, the likelihood has the form:

$$L(\text{BR}, \theta) = \text{Poisson} [N^{\text{obs}} | N^{\text{exp}}(\text{BR}, \theta)] \cdot G(\theta), \quad (11.2)$$

where BR is the parameter of interest and θ represent nuisance parameters associated with systematic uncertainties. N^{obs} is the number of the observed events, $N^{\text{exp}}(\text{BR}, \theta)$ is the expected number of events, and $G(\theta)$ is a set of constraints on the nuisance parameters within their estimated uncertainties. The number of expected events is the sum of signal and background events. The number of signal events is calculated from the integrated luminosity, the $e^+e^- \rightarrow ZH$ cross section $\sigma(ZH)$ measured from the recoil mass method, Higgs boson branching ratio BR, the event selection efficiency ϵ . The number of the expected background events, N^b , is estimated from Monte Carlo samples. Thus

$$N^{\text{exp}}(\text{BR}, \theta) = \text{Lumi}(\theta^{\text{lumi}}) \times \sigma_{ZH}(\theta^\sigma) \times \text{BR} \times \epsilon(\theta^\epsilon) + N^b(\theta^b), \quad (11.3)$$

where θ^X ($X = \text{lumi}, \sigma, \epsilon$ and b) are the nuisance parameters of their corresponding parameters or measurements. Even with 10^6 Higgs boson events, statistical uncertainties

- 1 are expected to be dominant and thus systematic uncertainties are not taken into account
 2 for the current studies. Thus the nuisance parameters are fixed to their nominal values.

Property	Estimated Precision	
m_H	5.9 MeV	
Γ_H	3.1%	
$\sigma(ZH)$	0.5%	
$\sigma(\nu\bar{\nu}H)$	3.0%	

Decay mode	$\sigma(ZH) \times \text{BR}$	BR
$H \rightarrow b\bar{b}$	0.27%	0.56%
$H \rightarrow c\bar{c}$	3.26%	3.30%
$H \rightarrow gg$	1.27%	1.36%
$H \rightarrow WW^*$	0.98%	1.10%
$H \rightarrow ZZ^*$	5.09%	5.11%
$H \rightarrow \gamma\gamma$	6.84%	6.86%
$H \rightarrow Z\gamma$	15%	15%
$H \rightarrow \tau^+\tau^-$	0.82%	0.96%
$H \rightarrow \mu^+\mu^-$	17%	17%
$H \rightarrow \text{inv}$	—	< 0.30%

Table 11.3: Estimated precision of Higgs boson property measurements expected from a CEPC dataset of 5.6 ab^{-1} at $\sqrt{s} = 240 \text{ GeV}$. All precision are relative except for m_H and $\text{BR}(H \rightarrow \text{inv})$ for which Δm_H and 95% CL upper limit on $\text{BR}_{\text{inv}}^{\text{BSM}}$ are quoted respectively. The $e^+e^- \rightarrow e^+e^-H$ cross section is too small to be measured with a reasonable precision.

- 3 Table 11.3 summarizes the estimated precision of Higgs boson property measure-
 4 ments, combining all studies described above and taking into account cross-feeds be-
 5 tween different Higgs boson production processes and decay modes. For the leading
 6 Higgs boson decay modes, namely $b\bar{b}$, $c\bar{c}$, gg , WW^* , ZZ^* and $\tau^+\tau^-$, percent level preci-
 7 sion are expected. The best achievable statistical uncertainties for 5.6 ab^{-1} are 0.27% for
 8 $\sigma(e^+e^- \rightarrow ZH) \times \text{BR}(H \rightarrow b\bar{b})$ and 0.5% for $\sigma(e^+e^- \rightarrow ZH)$. Even for these measure-
 9 ments, statistics is likely the dominant source of uncertainties. Systematic uncertainties
 10 from the efficiency/acceptance of the detector, the luminosity and the beam energy deter-
 11 mination are expected to be small. The integrated luminosity can be measured with a 0.1%
 12 precision, a benchmark already achieved at the LEP [16], and can be potentially improved
 13 in the future. The center-of-mass energy will be known better than 1 MeV, resulting neg-
 14 ligible uncertainties on the theoretical cross section predictions and experimental recoil
 15 mass measurements.

11.1.6 Higgs boson width

The Higgs boson width is of special interest as it is sensitive to BSM physics in Higgs boson decays that are not directly detectable or searched for. However, the 4.07 MeV width predicted by the SM is too small to be measured with a reasonable precision from the distributions of either the invariant mass of the Higgs boson decay products or the recoil mass of the system produced in association with the Higgs boson. Unique to lepton colliders, the width can be determined from the measurements of Higgs boson production cross sections and its decay branching ratios. This is because the inclusive $e^+e^- \rightarrow ZH$ cross section $\sigma(ZH)$ can be measured from the recoil mass distribution, independent of Higgs boson decays.

Measurements of $\sigma(ZH)$ and BR's have been discussed in above. Combining these measurements, the Higgs boson width can be calculated in a model-independent way:

$$\Gamma_H = \frac{\Gamma(H \rightarrow ZZ^*)}{\text{BR}(H \rightarrow ZZ^*)} \propto \frac{\sigma(ZH)}{\text{BR}(H \rightarrow ZZ^*)} \quad (11.4)$$

Here $\Gamma(H \rightarrow ZZ^*)$ is the partial width of the $H \rightarrow ZZ^*$ decay. Because of the small expected $\text{BR}(H \rightarrow ZZ^*)$ value for a 125 GeV Higgs boson (2.64% in the SM), the precision of Γ_H is limited by the $H \rightarrow ZZ^*$ statistics. It can be improved using decay final states with expected large BR values, for example the $H \rightarrow b\bar{b}$ decay:

$$\Gamma_H = \frac{\Gamma(H \rightarrow b\bar{b})}{\text{BR}(H \rightarrow b\bar{b})} \quad (11.5)$$

$\Gamma(H \rightarrow b\bar{b})$ can be independently extracted from the cross section of the W fusion process:

$$\sigma(\nu\bar{\nu}H \rightarrow \nu\bar{\nu}b\bar{b}) \propto \Gamma(H \rightarrow WW^*) \cdot \text{BR}(H \rightarrow b\bar{b}) = \Gamma(H \rightarrow b\bar{b}) \cdot \text{BR}(H \rightarrow WW^*) \quad (11.6)$$

Thus the Higgs boson total width

$$\Gamma_H = \frac{\Gamma(H \rightarrow b\bar{b})}{\text{BR}(H \rightarrow b\bar{b})} = \frac{\Gamma(H \rightarrow WW^*)}{\text{BR}(H \rightarrow WW^*)} \propto \frac{\sigma(\nu\bar{\nu}H)}{\text{BR}(H \rightarrow WW^*)} \quad (11.7)$$

Here $\text{BR}(H \rightarrow b\bar{b})$ and $\text{BR}(H \rightarrow WW^*)$ are measured from the $e^+e^- \rightarrow ZH$ process. The limitation of this method is the precision of the $\sigma(e^+e^- \rightarrow \nu_e\bar{\nu}_eH)$ measurement.

The expected precision on Γ_H is 5.4% from the measurements of $\sigma(ZH)$ and $\text{BR}(H \rightarrow ZZ^*)$ and is 3.3% from the measurements of $\sigma(\nu\bar{\nu}H)$ and $\text{BR}(H \rightarrow WW^*)$. The former is dominated by the precision of the $\text{BR}(H \rightarrow ZZ^*)$ measurement while the latter by the $\sigma(\nu\bar{\nu}H)$ measurement. The combined Γ_H precision of the two measurements is 3.1%, taking into account correlations between the two measurements.

11.1.7 Higgs Boson Coupling Measurements

To understand the implications of the predicted measurement precision shown in Table 11.3 on possible new physics models, one would need to translate them into constraints on the parameters in the Lagrangian. This is frequently referred to as Higgs boson coupling measurement, even though this way of phrasing it can be misleading as discussed in the following.

1 There are different ways of presenting the constraints. Before going into CEPC re-
 2 sults, we briefly comment on the reasons behind choices of schemes in this section. First,
 3 the goal of theory interpretation is different from analyzing actual data, where a lot of
 4 detailed work will be done to derive the extended sets of observables. Instead, obtaining
 5 a broad brushed big picture of the basic capability of the Higgs boson coupling measure-
 6 ment at the CEPC is the goal. Ideally, the presentation would be simple with a intuitive
 7 connection with the observables. The presentation would ideally also be free of under-
 8 lying model assumptions. In addition, it would be convenient if the result presentation
 9 can be interfaced directly with higher order computations, RGE evolutions, and so on.
 10 However, achieving all of these goals simultaneously is not possible. Two of the most
 11 popular and balanced approaches are the so-called κ -framework and the Effective Field
 12 Theory (EFT) analysis. As discussed in more detail later, none of these is perfect. At the
 13 same time, neither of these is wrong as long as one is careful not to over interpreting the
 14 result. Another important aspect of making projections on the physics potential of a future
 15 experiment is that they will be compared with other possible future experiments. Hence,
 16 CEPC follows the most commonly used approaches to facilitate such comparisons.

17 Motivated by these arguments, in the following, CEPC presents the projections using
 18 both the κ -framework and EFT approach. In the later part of this section, Higgs physics
 19 potential beyond coupling determination will be discussed.

20 11.1.7.1 Coupling fits in the κ -framework

21 The Standard Model makes specific predictions for the Higgs boson couplings to the SM
 22 fermions, $g(Hff; \text{SM})$, and to the SM gauge bosons $g(HVV; \text{SM})$.³ In the κ -framework,
 23 the potential deviations are parametrized by

$$\kappa_f = \frac{g(Hff)}{g(Hff; \text{SM})}, \quad \kappa_V = \frac{g(HVV)}{g(HVV; \text{SM})}, \quad (11.8)$$

24 with $\kappa_i = 1$ indicating agreement with the SM prediction.

25 In addition to couplings which are present at tree level, the Standard Model also
 26 predicts effective couplings $H\gamma\gamma$ and Hgg , in terms of other SM parameters. Changes
 27 in the gluon and photon couplings can be induced by the possible shifts in the Higgs
 28 boson couplings described above. In addition, these couplings can also be altered by loop
 29 contributions from new physics states. Hence, these couplings will be introduced as two
 30 independent couplings, with their ratios to the SM predictions denoted as κ_γ and κ_g .

31 Furthermore, it is possible that the Higgs boson can decay directly into new physics
 32 particles. In this case, two type of new decay channels will be distinguished:

- 33 1. Invisible decay. This is a specific channel in which Higgs boson decay into invisible
 34 particles. This can be searched for and, if detected, measured.
- 35 2. Exotic decay. This includes all the other new physics channels. Whether they can
 36 be observed, and, if so, to what precision, depends sensitively on the particular final
 37 states. In one extreme, they can be very distinct and can be measured very well. In
 38 another extreme, they can be in a form which is completely swamped by the back-
 39 ground. Whether postulating a precision for the measurement of the exotic decay or
 40 treating it as an independent parameter (essentially assuming it can not be measured

³For the discussion of coupling fits and their implications, “ H ” is used to denoted the 125 GeV Higgs boson.

directly) is an assumption one has to make. In the latter case, it is common to use the total width Γ_H as an equivalent free parameter.⁴

In general, possible deviations of all Standard Model Higgs boson couplings should be considered. However, in the absence of obvious light new physics states with large couplings to the Higgs boson and other SM particles, a very large deviation ($> \mathcal{O}(1)$) is unlikely. In the case of smaller deviations, the Higgs boson phenomenology will not be sensitive to the deviations [17] $\kappa_e, \kappa_u, \kappa_d$ and κ_s . Therefore, they will not be considered here and set to be their SM values.

The CEPC will not be able to directly measure the Higgs boson coupling to top quarks. A deviation of this coupling from its SM value does enter $H\gamma\gamma$ and Hgg amplitudes. However, this can be viewed as parametrized by κ_γ and κ_g already. Therefore, we will not include κ_t as an independent parameter. Hence, the following set of 10 independent parameters is considered:

$$\kappa_b, \kappa_c, \kappa_\tau, \kappa_\mu, \kappa_Z, \kappa_W, \kappa_\gamma, \kappa_g, \text{BR}_{\text{inv}}^{\text{BSM}}, \Gamma_H. \quad (11.9)$$

Several assumptions can be made that can lead to a reduced number of parameters (see also [18, 19]). It can be reduced to a 7-parameter set, by assuming lepton universality, and the absence of exotic and invisible decays (excluding $H \rightarrow ZZ^* \rightarrow \nu\bar{\nu}\nu\bar{\nu}$) [18, 20]:

$$\kappa_b, \kappa_c, \kappa_\tau = \kappa_\mu, \kappa_Z, \kappa_W, \kappa_\gamma, \kappa_g. \quad (11.10)$$

This is useful for hadron collider studies since it can not measure the Higgs boson total width with precision; it is more useful for models in which this assumption is satisfied.

There are some pros and cons of the κ -framework. κ_i s give a simple and intuitive parameterization of potential deviations. It has a direct connection with the observables shown in Table 11.3. It does cover a lot of possible modifications of the coupling. At the same time, κ -framework has its limitations. Strictly speaking, it should not be understood as modifying the SM renormalizable Lagrangian by a multiplicative factor. For instance, individual κ modifications violates gauge invariance. The higher order corrections in the κ framework is not easily defined. κ_i s do not summarize all possible effects of new physics neither. For example, in addition to the overall size, potential new physics can also introduce form factors which can change the kinematics of particles connected to a vertex. Manifestations of this effect will be seen in the discussion of the EFT approach. It is useful to pause here and compare with the EFT scheme introduced in detail in the next subsection. The EFT scheme relates κ_Z and κ_W , and further expance them into three different Lorentz structures. In addition, some of these higher dimensional HVV coupling are also in connection with κ_γ and anomalous trilinear gauge couplings. The current EFT scheme does not include important new degree of freedom $\text{BR}_{\text{inv}}^{\text{BSM}}$ and Γ_H as independent parameters. Overall, κ -framework does capture the big picture of the capability of precision Higgs boson measurement at CEPC. It is useful as long as we understand its limitation.

The LHC and especially the HL-LHC will provide valuable and complementary information about the Higgs boson properties. For example, the LHC is capable of directly measure the ttH process [21, 22]. In addition, the LHC could use differential cross sections to differentiate top-loop contributions and other heavy particle-loop contributions to

⁴Total width is a very useful parameter in understanding and deriving parameter precisions in the κ -scheme.

1 the Higgs boson to gluon coupling [23–26], and similarly to separate contributions from
 2 different operators to the Higgs boson to vector boson couplings [27]. For the purpose
 3 of the coupling fit in the κ -framework, the LHC with its large statistics, helps improving
 4 precision on rare processes such as Higgs to diphoton couplings. Note that a large por-
 5 tion of the systematics intrinsic to a hadron collider would be canceled by taking ratios of
 6 measured cross sections. For example, combining the ratio of the rates $pp \rightarrow H \rightarrow \gamma\gamma$
 7 and $pp \rightarrow H \rightarrow ZZ^*$ and the measurement of HZZ coupling at the CEPC can signifi-
 8 cantly improve the measurement of κ_γ . These are the most useful inputs from the LHC to
 9 combine with the CEPC. Similar studies of combination with the LHC for the ILC can be
 10 found in Refs. [28–32].

	10-parameter fit		7-parameter fit	
	CEPC	+HL-LHC	CEPC	+HL-LHC
Γ_H	3.1	2.5	–	–
κ_b	1.6	1.2	1.5	1.1
κ_c	2.2	1.9	2.2	1.9
κ_g	1.6	1.3	1.6	1.2
κ_W	1.4	1.1	1.4	1.0
κ_τ	1.5	1.2	1.5	1.1
κ_Z	0.25	0.25	0.15	0.15
κ_γ	3.7	1.6	3.7	1.6
κ_μ	8.7	5.0	–	–
$\text{BR}_{\text{inv}}^{\text{BSM}}$	0.30	0.30	–	–

Table 11.4: Coupling measurement precision in percentage from the 7-parameter fit and 10-parameter fit described in the text for the CEPC, and corresponding results after combination with the HL-LHC. All the numbers refer to are relative precision except for $\text{BR}_{\text{inv}}^{\text{BSM}}$ of beyond standard model for which 95% CL upper limit are quoted respectively. Some entries are left vacant for the 7-parameter fit to stress them being dependent parameter under the fitting assumptions of the 7-parameter fit scheme.

11 The 10-parameter fit and the 7-parameter fit for CEPC with integrate luminosity
 12 of 5.6 ab^{-1} are shown in Table 11.4. In addition, the combinations with expectations
 13 (optimistically assuming no theoretical uncertainties) from the HL-LHC from Ref. [33]
 14 are shown in the same tables as well.⁵ We assume the HL-LHC will operate at 14 TeV
 15 center-of-mass energy and accumulate an integrated luminosity of 3000 fb^{-1} .

16 The CEPC Higgs boson properties measurements mark a giant step beyond the HL-
 17 LHC. First of all, in contrast to the LHC, a lepton collider Higgs factory is capable of
 18 measuring the absolute width and coupling strengths of the Higgs boson. A comparison
 19 with the HL-LHC is only possible with model dependent assumptions. One of such com-
 20 parison is within the framework of a 7-parameter fit, shown in Figure 11.8. Even with this
 21 set of restrictive assumptions, the advantage of the CEPC is still significant. The measure-

⁵We note here that the LHC and the CEPC have different sources of theoretical uncertainties, for detailed discussion, see Refs. [19, 20, 34–36].

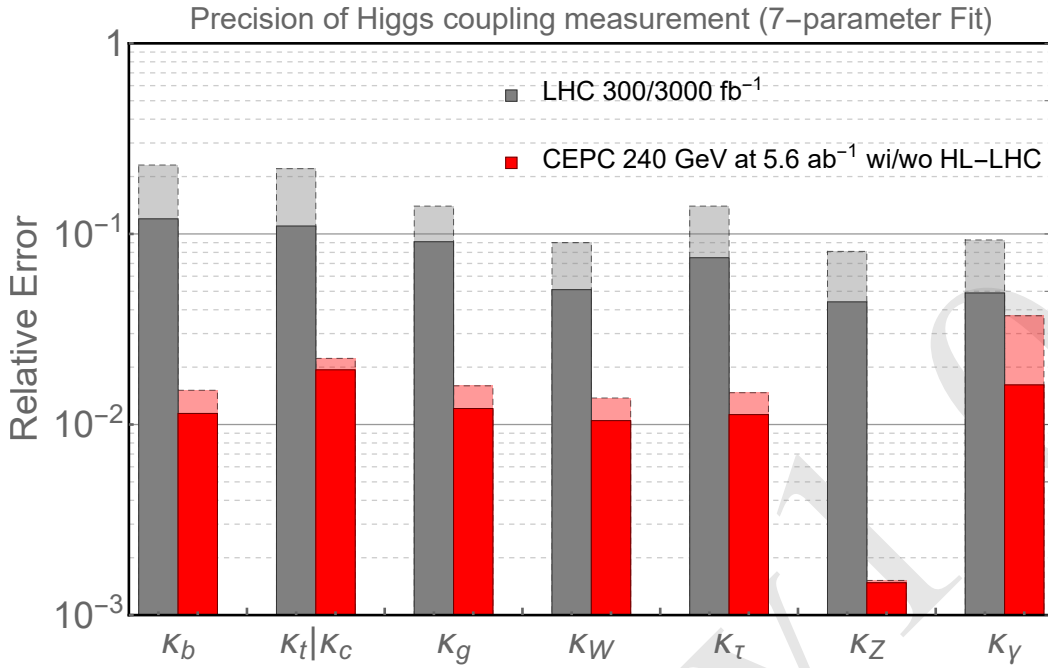

Figure 11.8: The 7 parameter fit result, and comparison with the HL-LHC [33]. The projections for the CEPC at 240 GeV with 5.6 ab^{-1} integrated luminosity are shown. The CEPC results without combination with the HL-LHC input are shown with dashed edges. The LHC projections for an integrated luminosity of 300 fb^{-1} are shown in dashed edges.

1 ment of κ_Z is more than a factor of 10 better. The CEPC can also improve significantly on
 2 a set of channels which suffers from large background at the LHC, such as κ_b , κ_c , and κ_g .
 3 Note that this is in comparison with the HL-LHC projection with aggressive assumptions
 4 about systematics. Such uncertainties are typically under much better control at lepton
 5 colliders. Within this 7-parameter set, the only coupling which the HL-LHC can give
 6 a competitive measurement is κ_γ , for which the CEPC's accuracy is limited by statistics.
 7 This is also the most valuable input that the HL-LHC can give to the Higgs boson coupling
 8 measurement at the CEPC, which underlines the importance of combining the results of
 9 these two facilities.

10 The direct search for Higgs boson decaying into invisible particles from BSM physics
 11 is well motivated, in close connection to dark sectors. The CEPC with 5.6 ab^{-1} can mea-
 12 sure this to a high accuracy as 95% upper limit 0.30%, as shown in Table 11.4. At the
 13 same time, the HL-LHC can only manage a much lower accuracy 6–17% [20] and some
 14 improved analysis may reach 2–3.5% [37].

15 As discussed above, one of the greatest advantages of lepton collider Higgs boson
 16 factory is the capability of determining the Higgs boson coupling *model independently*.
 17 The projection of such a determination at the CEPC is shown in Figure 11.9. The ad-
 18 vantage of the higher integrated luminosity at a circular lepton collider is apparent. The
 19 CEPC has a clear advantage in the measure of κ_Z . It is also much stronger in κ_μ and
 20 $\text{BR}_{\text{inv}}^{\text{BSM}}$ measurements.

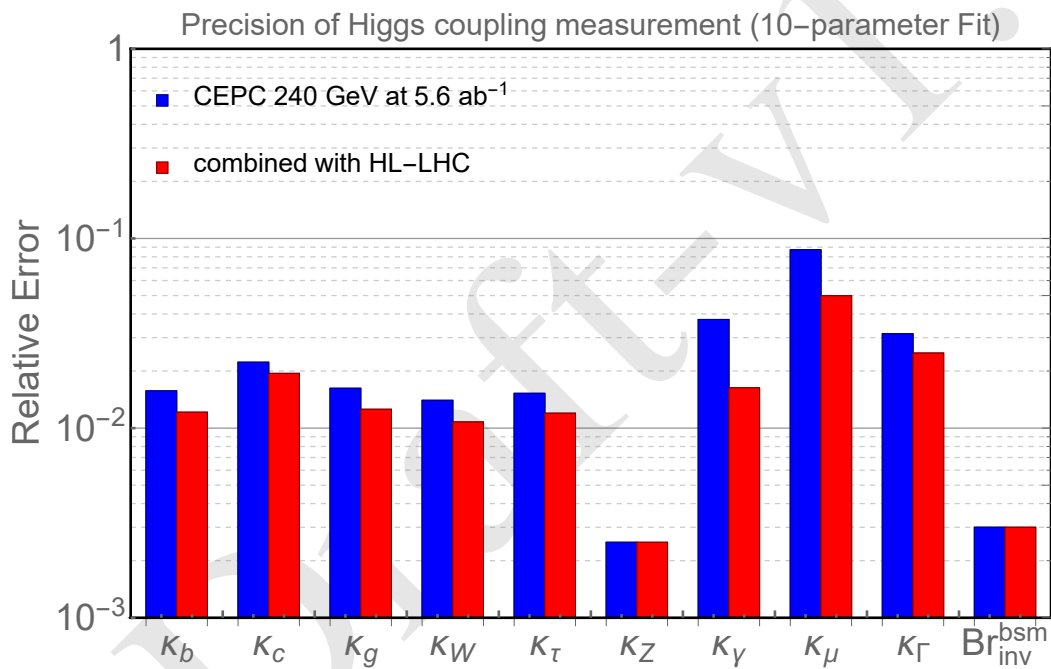

Figure 11.9: The 10 parameter fit result for CEPC at 240 GeV with 5.6 ab⁻¹ integrated luminosity (blue) and in combination with HL-LHC inputs (red). All the numbers refer to are relative precision except for BR_{inv}^{BSM} for which 95% CL upper limit are quoted respectively.

11.1.7.2 Effective-field-theory analysis

With the assumption that the new physics particles are heavier than the relevant energy of the Higgs factory, their effect can be characterized in the effective-field-theory (EFT) framework, in which higher dimensional operators supplement the Standard Model Lagrangian. Imposing baryon and lepton numbers conservations, all higher dimensional operators are of even dimension:

$$\mathcal{L}_{\text{EFT}} = \mathcal{L}_{\text{SM}} + \sum_i \frac{c_i^{(6)}}{\Lambda^2} \mathcal{O}_i^{(6)} + \sum_j \frac{c_j^{(8)}}{\Lambda^4} \mathcal{O}_j^{(8)} + \dots \quad (11.11)$$

The leading effects of new physics at the electroweak scale would be the dimension-six operators. To obtain robust constraints on the Wilson coefficients c_i , a global analysis is required which includes the contributions from all possible dimension-six operators. While a large number of dimension-six operators can be written down, only a subset of them contribute to the Higgs boson processes at leading order. Among these operators, some are much better constrained by other measurements. It is thus reasonable to focus on the operators that primarily contribute to the Higgs boson processes and reduce the parameter space by making appropriate assumptions, as done in many recent studies of EFT global analysis at future lepton colliders [32, 38–43]. Following these studies, the CP -violating operators as well as the ones that induce fermion dipole interactions are discarded in this analysis. At leading order, CP -violating operators do not have linear contributions to the rates of Higgs boson processes. While they do contribute to the angular observables at the leading order [44, 45], these operators are usually much better constrained by EDM experiments [46–48], though some rooms are still possible for the CP -violating couplings of Higgs boson to the heavy flavor quarks and leptons [49, 50]. The interference between the fermion dipole interactions with SM terms are suppressed by the fermion masses. The corresponding operators also generate dipole moments, which are stringently constrained especially for light fermions. For the operators that modify the Yukawa matrices, only the five diagonal ones that correspond to the top, charm, bottom, tau, and muon Yukawa couplings are considered, which are relevant for the Higgs boson measurements at CEPC.

Before presenting the projections, some brief comments on the EFT framework are in order. In comparison with the κ -framework, a significant advantage of the EFT framework is that it gives physical parametrizations of the new physics effect. EFT operators can be used directly in computations. It also allows natural inclusions of new observables, with possible correlations automatically taken into account. At the same time, the connections with experimental observables are less direct and intuitive. Sometimes, the EFT approach is referred to as model-independent. This is only accurate to a certain extent. At least, it assumes that there are no new light degrees of freedom. In practice, assumptions are often made to simplify the set of EFT operators, as also done here.

The electroweak precision observables are already tightly constrained by the LEP Z -pole and W mass measurements. The CEPC Z -pole run can further improve the constraints set by LEP, thanks to the enormous amount ($\sim 10^{11}$) of Z bosons that can be collected. The W mass can also be constrained within a few MeVs at CEPC even without a dedicated WW threshold run. Given that the expected precisions of the Z -pole observables and the W mass are much higher than the ones of Higgs boson observables, in the Higgs boson analysis, it is assumed that the former ones are perfectly constrained, which significantly simplifies the analysis. In particular, in a convenient basis all the contact

1 interaction terms of the form $HVf\bar{f}$ can be discarded since they also modify the fermion
 2 gauge couplings. Realistic Z -pole constraints have also been considered in recent stud-
 3 ies [32, 41, 43], but certain assumptions (such as flavor-universality) and simplifications
 4 are made. Future studies with more general frameworks are desired to fully determine the
 5 impact of the Z -pole measurements on the Higgs boson analysis.

CEPC 240 GeV (5.6 ab^{-1})				
	uncertainty	correlation matrix		
		$\delta g_{1,Z}$	$\delta \kappa_\gamma$	λ_Z
$\delta g_{1,Z}$	1.2×10^{-3}	1	0.08	-0.90
$\delta \kappa_\gamma$	0.9×10^{-3}		1	-0.42
λ_Z	1.3×10^{-3}			1

Table 11.5: The estimated constraints on aTGCs from the measurements of the diboson process ($e^+e^- \rightarrow WW$) in the semi-leptonic channel at CEPC 240 GeV with 5.6 ab^{-1} data and unpolarized beams. All angular distributions are used in the fit. Only the statistical uncertainties of the signal events are considered, assuming a selection efficiency of 80%.

6 The measurements of the triple gauge couplings (TGCs) from the diboson process
 7 ($e^+e^- \rightarrow WW$) play an important role in the Higgs boson coupling analysis under the
 8 EFT framework. Focusing on CP -even dimension-six operators, the modifications to the
 9 triple gauge vertices from new physics can be parametrized by three anomalous TGC
 10 parameters (aTGCs), conventionally denoted as $\delta g_{1,Z}$, $\delta \kappa_\gamma$ and λ_Z [51, 52]. Among them,
 11 $\delta g_{1,Z}$ and $\delta \kappa_\gamma$ are generated by operators that also contribute to the Higgs boson processes.
 12 At 240 GeV, the cross section of $e^+e^- \rightarrow WW$ is almost two orders of magnitude larger
 13 than the one of the Higgsstrahlung process. The measurements of the diboson process thus
 14 provide strong constraints on the operators that generate the aTGCs. A dedicated study
 15 on the TGC measurements at CEPC is not available at the current moment. A simplified
 16 analysis is thus performed to estimate the precision reaches on the aTGCs. The results are
 17 shown in Table 11.5. The analysis roughly follows the methods in Refs. [40, 53]. Only
 18 the WW events in the semi-leptonic (electron or muon) channel are used, which have
 19 good event reconstructions and also a sizable branching fraction ($\approx 29\%$). In particular,
 20 the production polar angle, as well as the two decay angles of the leptonic W , can be
 21 fully reconstructed, which contain important information on the aTGCs. The two decay
 22 angles of the hadronic W can only be reconstructed with a two-fold ambiguity. A χ^2 fit of
 23 the three aTGC parameters to the binned distribution of all five angles is performed, from
 24 which the one-sigma precisions of the three aTGCs as well as the correlations among them
 25 are extracted. A signal selection efficiency of 80% is assumed. The effects of systematics
 26 and backgrounds are not considered, assuming they are under control after the selection
 27 cuts.

28 Under the assumptions specified above, the contributions to the Higgs boson and di-
 29 boson processes from dimension-six operators consist of a total number of twelve degrees
 30 of freedom. While all non-redundant basis are equivalent, it is particularly convenient to
 31 choose a basis in which the twelve degrees of freedom can be mapped to exactly twelve
 32 operators, while the rest are removed by the assumptions. Two such bases are consid-
 33 ered in our analysis, one is defined by the set of dimension-six operators in Table 11.6,

$\mathcal{O}_H = \frac{1}{2}(\partial_\mu H^2)^2$	$\mathcal{O}_{GG} = g_s^2 H ^2 G_{\mu\nu}^A G^{A,\mu\nu}$
$\mathcal{O}_{WW} = g^2 H ^2 W_{\mu\nu}^a W^{a,\mu\nu}$	$\mathcal{O}_{y_u} = y_u H ^2 \bar{Q}_L \tilde{H} u_R \quad (u \rightarrow t, c)$
$\mathcal{O}_{BB} = g'^2 H ^2 B_{\mu\nu} B^{\mu\nu}$	$\mathcal{O}_{y_d} = y_d H ^2 \bar{Q}_L H d_R \quad (d \rightarrow b)$
$\mathcal{O}_{HW} = ig(D^\mu H)^\dagger \sigma^a (D^\nu H) W_{\mu\nu}^a$	$\mathcal{O}_{y_e} = y_e H ^2 \bar{L}_L H e_R \quad (e \rightarrow \tau, \mu)$
$\mathcal{O}_{HB} = ig'(D^\mu H)^\dagger (D^\nu H) B_{\mu\nu}$	$\mathcal{O}_{3W} = \frac{1}{3!} g \epsilon_{abc} W_\mu^{a\nu} W_\nu^b W^{c\rho\mu}$

Table 11.6: A complete set of CP -even dimension-six operators that contribute to the Higgs boson and TGC measurements, assuming there is no correction to the Z -pole observables and the W mass, and also no fermion dipole interaction. For \mathcal{O}_{y_u} , \mathcal{O}_{y_d} and \mathcal{O}_{y_e} , only the contributions to the diagonal elements of the Yukawa matrices that corresponds to the top, charm, bottom, tau, and muon Yukawa couplings are considered.

the other is the so-called ‘‘Higgs basis,’’ proposed in Ref. [54]. In the Higgs basis, the parameters are defined in the broken electroweak phase, and can be directly interpreted as the size of the Higgs boson couplings. Different from the original Higgs basis, this analysis follows Ref. [40], with the parameters associated with the Hgg , $H\gamma\gamma$ and $HZ\gamma$ vertices normalized to the SM one-loop contributions, and denoted as \bar{c}_{gg} , $\bar{c}_{\gamma\gamma}$ and $\bar{c}_{Z\gamma}$. The parameter $\bar{c}_{gg}^{\text{eff}}$ is further defined to absorb all contributions to the Hgg vertex. These redefined parameters can be more conveniently interpreted as the precisions of the Higgs boson couplings analogous to those in the κ framework. The exact definitions of the Higgs basis and the translation to the basis in Table 11.6 can be found in the end of the section.

The estimated precisions of all the Higgs boson rate measurements in Section 11.1.5 (Table 11.3), along with the correlations among them, are included as inputs for the EFT global analysis. In addition, the angular observables of the channel $e^+e^- \rightarrow ZH$, $Z \rightarrow \ell^+\ell^-$, $H \rightarrow b\bar{b}$ are included, following the studies in Refs. [44, 45]. This channel is almost background-free after the selection cuts, with a signal selection efficiency of about 40%. For the TGC measurements, the results in Table 11.5 are used as inputs. The global χ^2 is obtained by summing over the χ^2 of all the measurements. Due to the high precision of the measurements, it is shown that for all observables, keeping only the linear terms of all EFT parameters gives a very good approximation [40]. This greatly simplifies the fitting procedure, as the total χ^2 can be written as

$$\chi^2 = \sum_{ij} (c - c_0)_i \sigma_{ij}^{-2} (c - c_0)_j, \quad \text{where} \quad \sigma_{ij}^{-2} \equiv (\delta c_i \rho_{ij} \delta c_j)^{-1}, \quad (11.12)$$

where c_i 's are the EFT parameters, c_0 's are the corresponding central values which are zero by construction, as the measurements are assumed to be SM-like. The one-sigma uncertainties δc_i and the correlation matrix ρ can be obtained from $\sigma_{ij}^{-2} = \partial^2 \chi^2 / \partial c_i \partial c_j$.

For comparison, the reaches of the LHC 14 TeV are also considered, with a total luminosities of 300 fb^{-1} or 3000 fb^{-1} , which are combined with the diboson ($e^+e^- \rightarrow WW$) measurements at LEP as well as the LHC 8 TeV Higgs boson measurements. For the LHC 14 TeV Higgs boson measurements, the projections by the ATLAS collaboration [33] are used, while the composition of each channel is obtained from Refs. [55–59]. The constraints from the LHC 8 TeV Higgs boson measurements and the diboson measurements at LEP are obtained directly from Ref. [60]. While the LHC diboson measurements could potentially improve the constraints on aTGCs set by LEP [61], they are

not included in this analysis due to the potential issues related to the validity of the EFT [62, 63] and the TGC dominance assumption [64].

The results of the 12-parameter fit at CEPC are shown in Figure 11.10 for the Higgs basis and Figure 11.11 for the basis in Table 11.6. The results from LHC Higgs boson measurements (both 300 fb^{-1} and 3000 fb^{-1}) combined with LEP diboson measurements are shown in comparison. The results of the combination of CEPC with HL-LHC (3000 fb^{-1}) are also shown in addition to the ones of CEPC alone. In Figure 11.10, the results are shown in terms of the one-sigma precision of each parameter. The LHC results are shown with gray columns with 300 fb^{-1} (3000 fb^{-1}) in light (solid) shades, while the CEPC ones are shown with the red columns, with the CEPC-alone (combination with HL-LHC) results shown in light (solid) shades. In Figure 11.11, the results are presented in terms of the reaches of $\Lambda/\sqrt{|c_i|}$ at 95% confidence level (CL), where Λ is the scale of new physics and c_i is the corresponding Wilson coefficient for each operator, defined in Eq. 11.11. Four columns are shown separately for LHC 300 fb^{-1} , LHC 3000 fb^{-1} , CEPC alone and CEPC combined with HL-LHC. The results of the global fits are shown with solid shades. The results from individual fits are shown with light shades, which are obtained by switching on one operator at a time with the rest fixed to zero.

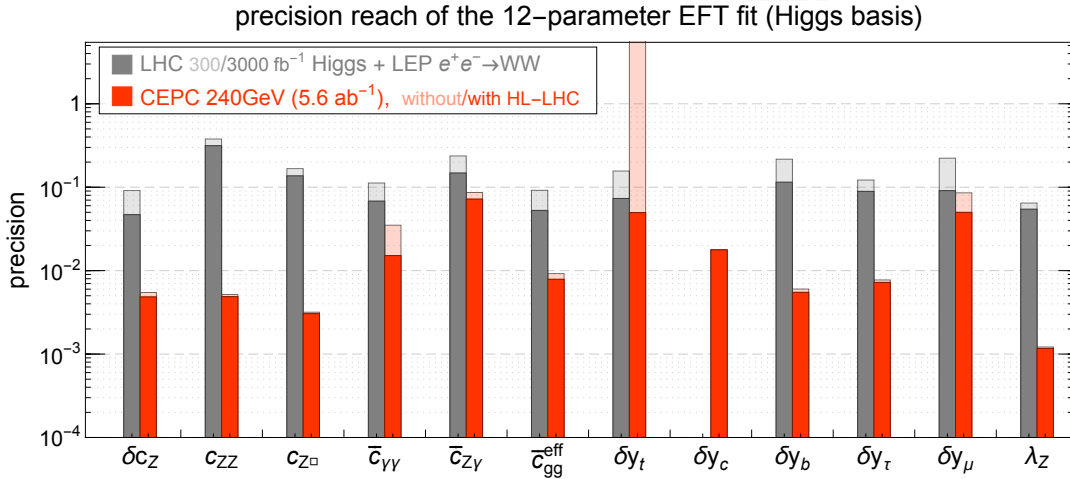

Figure 11.10: One-sigma precision reach of the twelve parameters in the Higgs basis. The first column shows the results from the LHC Higgs boson measurements with 300 fb^{-1} (light shade) and 3000 fb^{-1} (solid shade) combined with LEP diboson ($e^+e^- \rightarrow WW$) measurement. The second column shows the results from CEPC with 5.6 ab^{-1} data collected at 240 GeV with unpolarized beam. The results from CEPC alone are shown in light shades, and the ones from a combination of CEPC and HL-LHC are shown in solid shades. δy_c is fixed to zero for the LHC fits.

It is transparent from Figure 11.10 that CEPC provides very good reaches on the precisions of Higgs boson couplings, which are of one order of magnitude better than the ones at the LHC. For the parameters $\bar{c}_{\gamma\gamma}$, $\bar{c}_{Z\gamma}$ and δy_μ , the clean signal and small branching ratios of the corresponding channels ($H \rightarrow \gamma\gamma/Z\gamma/\mu\mu$) makes the HL-LHC precisions comparable with the CEPC ones. The combination with additional LHC measurements thus provides non-negligible improvements, especially for those parameters. It should be noted that, while δy_t modifies the Hgg vertex via the top loop contribution, CEPC alone could not discriminate it from the Hgg contact interaction obtained from integrating out a heavy new particle in the loop. The parameter $\bar{c}_{gg}^{\text{eff}}$ absorbs both contributions and reflects the overall precision of the Hgg coupling. The combination with the LHC $t\bar{t}H$ measure-

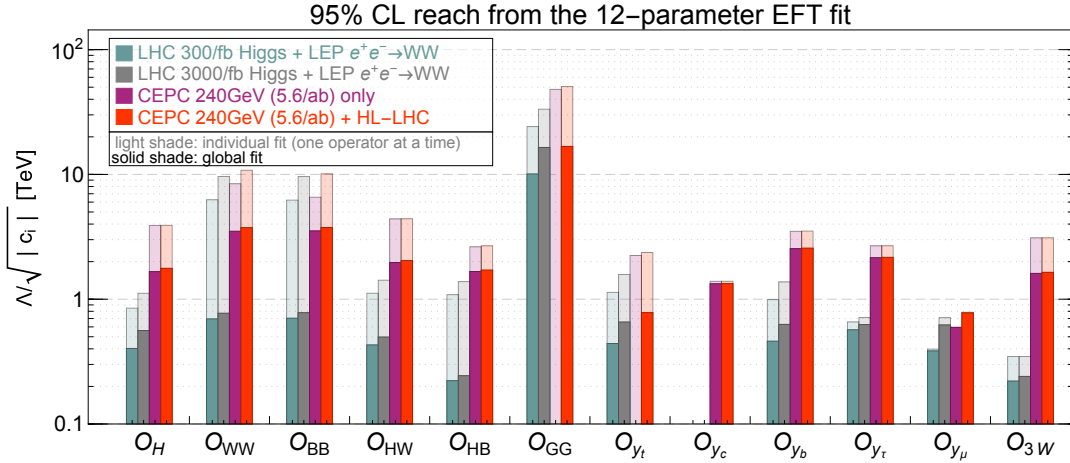

Figure 11.11: The 95% CL reach on $\Lambda/\sqrt{|c_i|}$ for the operators in the basis defined in Table 11.6. The first two columns show the results from LHC Higgs boson measurements with 300 fb^{-1} and 3000 fb^{-1} combined with LEP diboson ($e^+e^- \rightarrow WW$) measurement. The last two columns show the results from CEPC alone and the combination of CEPC and HL-LHC (3000 fb^{-1}). The results of the global fits are shown with solid shades. The results from individual fits (by switching on one operator at a time) are shown with light shades. δy_c is fixed to zero for the LHC fits.

1 measurements could resolve this flat direction. The CEPC measurements, in turn, could improve
 2 the constraint on δy_t set by the LHC by providing much better constraints on the other
 3 parameters that contribute to the $t\bar{t}H$ process. It should also be noted that the measure-
 4 ment of the charm Yukawa coupling is not reported in Ref. [33], while the projection of
 5 its constraint has a large variation among different studies and can be much larger than
 6 one [65–70]. Therefore, δy_c is fixed to be zero for the LHC-only fits, as treating δy_c as an
 7 unconstrained free parameter generates a flat direction in the fit which makes the overall
 8 reach much worse. The CEPC, on the other hand, provides excellent measurements of the
 9 charm Yukawa and can constrain δy_c to a precision of $\sim 2\%$.

10 Regarding the reaches of $\Lambda/\sqrt{|c_i|}$ in Figure 11.11, it is also clear that CEPC has a
 11 significantly better performance than the LHC. If the couplings are naïvely assumed to be
 12 of order one ($c_i \sim 1$), the Higgs boson measurements at CEPC would be sensitive to new
 13 physics scales at multiple TeVs. While the individual reach for some of the operators at the
 14 LHC can be comparable to the ones at CEPC (e.g., O_{WW} and O_{BB} from the measurement
 15 of $H \rightarrow \gamma\gamma$), the reaches of CEPC are much more robust under a global framework
 16 thanks to its comprehensive measurements of both the inclusive ZH cross section and
 17 the exclusive rates of many Higgs boson decay channels. Operators O_{GG} and O_{yt} both
 18 contribute to the Hgg vertex. While the CEPC could provide strong constraints on either
 19 of them if the other is set to zero, they can only be constrained in a global fit if the $t\bar{t}H$
 20 measurements at the LHC are also included. It is also important to note that the validity of
 21 EFT could be a potential issue for the LHC measurements [62]. Depending on the size of
 22 the couplings, the inferred bounds on the new physics scale Λ could be comparable with
 23 or even smaller than the energy scale probed by the LHC. The CEPC has a smaller center
 24 of mass energy and much better precisions, which ensures the validity of EFT for most
 25 new physics scenarios.

26 In Table 11.7, the numerical results of the global fit are presented for CEPC in terms
 27 of the one-sigma precisions of the 12 parameters and the correlations among them. The

1 results assume an integrated luminosity of 5.6 ab^{-1} at 240 GeV with unpolarized beams,
 2 both without and with the combination of HL-LHC (3000 fb^{-1}) Higgs boson measure-
 3 ments. With both the one-sigma bounds and the correlation matrix, the corresponding
 4 *chi-squared* can be reconstructed, which can be used to derive the constraints in any other
 5 EFT basis or any particular model that can be matched to the EFT. This offers a con-
 6 venient way to study the reaches on new physics models, as detailed knowledge of the
 7 experimental measurements are not required.

Higgs basis											
δc_Z	c_{ZZ}	$c_{Z\Box}$	$\bar{c}_{\gamma\gamma}$	$\bar{c}_{Z\gamma}$	$\bar{c}_{gg}^{\text{eff}}$	δy_t	δy_c	δy_b	δy_τ	δy_μ	λ_Z
0.0055	0.0052	0.0032	0.035	0.086	0.0092	–	0.018	0.0060	0.0077	0.086	0.0012
0.0048	0.0049	0.0031	0.015	0.072	0.0079	0.050	0.018	0.0055	0.0072	0.050	0.0012
$c_i/\Lambda^2 [\text{TeV}^{-2}]$ of dimension-six operators											
c_H	c_{WW}	c_{BB}	c_{HW}	c_{HB}	c_{GG}	c_{y_t}	c_{y_c}	c_{y_b}	c_{y_τ}	c_{y_μ}	c_{3W}
0.18	0.041	0.040	0.13	0.18	–	–	0.28	0.077	0.11	1.4	0.19
0.16	0.036	0.035	0.12	0.17	0.0018	0.82	0.28	0.076	0.11	0.83	0.19

Table 11.7: The one-sigma uncertainties for the 12 parameters from CEPC (240 GeV, 5.6 ab^{-1}) in the Higgs basis and the basis of dimension-six operators. For both cases, the upper (lower) row correspond to results without (with) the combination of the HL-LHC Higgs boson measurements.. Note that, without the $t\bar{t}H$ measurements, δy_t can not be constrained in a global fit, thus c_{GG} and c_{y_t} can not be resolved.

8 In the EFT framework, it is explicitly assumed that the Higgs boson total width is
 9 the sum of all the widths of its SM decay channels. This is because the EFT expansion in
 10 Eq. 11.11 relies on the assumption that the new physics scale is sufficiently large, while
 11 any potential Higgs boson exotic decay necessarily introduces light BSM particles, thus
 12 in direct conflict with this assumption. One could nevertheless treat the Higgs boson total
 13 width as a free parameter in the EFT global fit and obtain an indirect constraint of it, as
 14 done in Ref. [32]. With this treatment, the CEPC could constrain the Higgs boson total
 15 width to a precision of 1.7% (1.6% if combined with HL-LHC). This result is significantly
 16 better than the one from the 10-parameter coupling fit in Table 11.4 (3.4%/2.6%). The
 17 improvement is mainly because the HWW and HZZ couplings are treated as being in-
 18 dependent in the 10-parameter coupling fit, while in the EFT framework they are related
 19 to each other under gauge invariance and custodial symmetry. It should also be noted that
 20 the Higgs boson width determined using Eq. (11.4) and (11.7) explicitly assumes that the
 21 HWW and HZZ couplings are independent of the energy scale. Such an assumption is
 22 not valid in the EFT framework with the inclusion of the anomalous couplings.

23 11.1.7.3 The Higgs boson self-coupling

24 The Higgs boson self-coupling is a critical parameter governing the dynamics of the elec-
 25 troweak symmetry breaking. In the Standard Model, the Higgs boson trilinear and quadri-
 26 linear couplings are fixed once the values of the electroweak VEV and the Higgs boson
 27 mass are known. Any deviation from the SM prediction is thus clear evidence of new
 28 physics beyond the SM. The Higgs boson trilinear coupling is probed at the LHC with the
 29 measurement of the di-Higgs process, $pp \rightarrow HH$. Current bounds on the Higgs boson
 30 trilinear coupling is at the $\mathcal{O}(10)$ level, while the HL-LHC is expected to improve the pre-
 31 cision to the level of $\mathcal{O}(1)$ [71]. The prospects for extracting the Higgs boson quadrilinear
 32 coupling are much less promising, even for a 100 TeV hadron collider [72].

1 To measure the di-Higgs-boson processes at a lepton collider, a sufficiently large
 2 center of mass energy ($\gtrsim 400$ GeV) is required, which is likely to be achieved only at a
 3 linear collider. The CEPC, instead, can probe the Higgs boson trilinear coupling via its
 4 loop contributions to the single Higgs boson processes. This indirect approach neverthe-
 5 less provides competitive reaches since the loop suppression is compensated by the high
 6 precision of the Higgs boson measurements at CEPC [73]. With a precision of 0.5% on
 7 the inclusive ZH cross section at 240 GeV, the Higgs boson trilinear coupling can be con-
 8 strained to a precision of 35%, assuming all other Higgs boson couplings that contributes
 9 to $e^+e^- \rightarrow ZH$ are SM-like.⁶ While this indirect bound is comparable to the direct ones at
 10 linear colliders, it relies on strong assumptions which are only applicable to some specific
 11 models. A more robust approach is to include all possible deviations on the Higgs boson
 12 couplings simultaneously and constrain the Higgs boson trilinear coupling in a global fit.
 13 The EFT framework presented in Section 11.1.7.2 is ideal for such an analysis. Under
 14 this framework, the one-loop contributions of the trilinear Higgs boson coupling to all the
 15 relevant Higgs boson production and decay processes are included, following Ref. [42].
 16 The new physics effect is parametrized by the quantity $\delta\kappa_\lambda \equiv \kappa_\lambda - 1$, where κ_λ is the ratio
 17 of the Higgs boson trilinear coupling to its SM value,

$$\kappa_\lambda \equiv \frac{\lambda_3}{\lambda_3^{\text{sm}}}, \quad \lambda_3^{\text{sm}} = \frac{m_H^2}{2v^2}. \quad (11.13)$$

18 The global fit is performed simultaneously with $\delta\kappa_\lambda$ and the 12 EFT parameters in Sec-
 19 tion 11.1.7.2. The results are presented in Table 11.8. The results for HL-LHC are also
 20 shown, which were obtained in Ref. [74] under the same global framework. For CEPC
 21 240 GeV, the one-sigma bound on $\delta\kappa_\lambda$ is around ± 3 , significantly worse than the 35% in
 22 the $\delta\kappa_\lambda$ -only fit. This is a clear indication that it is difficult to resolve the effects of $\delta\kappa_\lambda$
 23 from those of other Higgs boson couplings. For HL-LHC, the reach on $\delta\kappa_\lambda$ is still domi-
 24 nated by the di-Higgs process. However, as a result of the destructive interferences among
 25 diagrams, the di-Higgs process at LHC could not constrain $\delta\kappa_\lambda$ very well on its positive
 26 side, even with the use of differential observables [75]. The combination of HL-LHC and
 27 CEPC 240 GeV thus provides a non-trivial improvement to the HL-LHC result alone, in
 28 particular for the two-sigma bound on the positive side, which is improved from +6.1 to
 29 +2.8. This is illustrated in Figure 11.12, which plots the profiled χ^2 as a function of $\delta\kappa_\lambda$
 30 for the two colliders.

bounds on $\delta\kappa_\lambda$	$\Delta\chi^2 = 1$	$\Delta\chi^2 = 4$
CEPC 240 GeV 5.6 ab^{-1}	$[-3.0, +3.1]$	$[-5.9, +6.2]$
HL-LHC	$[-0.9, +1.3]$	$[-1.7, +6.1]$
HL-LHC + CEPC 240 GeV	$[-0.8, +1.0]$	$[-1.5, +2.7]$

Table 11.8: The $\Delta\chi^2 = 1$ (one-sigma) and $\Delta\chi^2 = 4$ (two-sigma) bounds of $\delta\kappa_\lambda$ for various scenarios, obtained in a global fit by profiling over all other EFT parameters. The results for HL-LHC are obtained from Ref. [74].

⁶ A better precision can be obtained by also using the exclusive channels, such as $\sigma(ZH) \times \text{BR}(H \rightarrow b\bar{b})$, but would require an even stronger assumption that all Higgs boson couplings contributing to the branching ratios are also SM-like except the Higgs boson trilinear coupling.

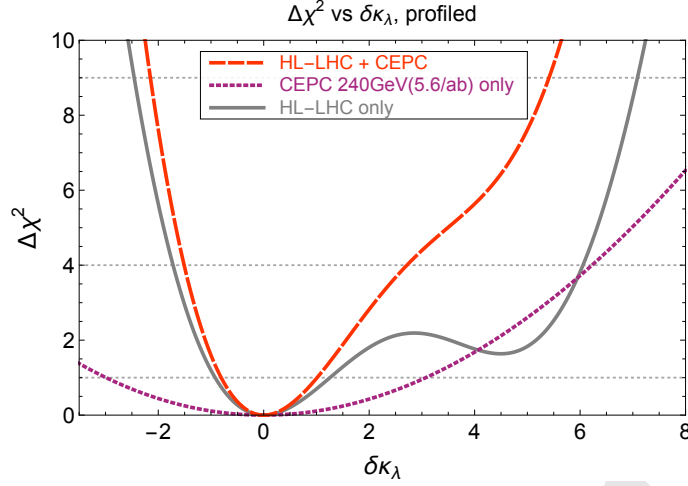

Figure 11.12: Chi-square as a function of $\delta\kappa_\lambda$ after profiling over all other EFT parameters for HL-LHC, CEPC and their combination.

11.1.7.4 Higgs and top couplings

Interactions of the Higgs boson with the top quark are widely viewed as a window to new physics beyond the Standard Model. Parametrizing effects of new physics in terms of dimension-six gauge-invariant operators modifying the Higgs-top interactions [76, 77], the Higgs-top couplings physics potential at CEPC can be evaluated [78–81]. This EFT basis enlarges the Higgs EFT considered above. Moreover, the CP violation effects in the third generation Yukawas can be reflected as the complexity of the Wilson coefficients of operator \mathcal{O}_{y_t} and \mathcal{O}_{y_b} ,

$$\Delta y_t = y_t^{\text{SM}} \left(\Re[C_{y_t}] \frac{v^3}{2m_t \Lambda^2} + i\Im[C_{y_t}] \frac{v^3}{2m_t \Lambda^2} \right) \quad (11.14)$$

$$\Delta y_b = y_b^{\text{SM}} \left(\Re[C_{y_b}] \frac{v^3}{2m_b \Lambda^2} + i\Im[C_{y_b}] \frac{v^3}{2m_b \Lambda^2} \right). \quad (11.15)$$

In this section, the effect of introducing CP phases in the Yukawa operators in Higgs boson physics are discussed. For more detailed discussion on a complete set of Higgs and Top operators, see Ref. [78]. The dominant sources of constraints are from $H \rightarrow \gamma\gamma$ and $H \rightarrow gg$ for \mathcal{O}_{y_t} , and $H \rightarrow gg$ and $H \rightarrow b\bar{b}$ for \mathcal{O}_{y_b} . Given that $H \rightarrow gg$ measurements are sensitive to both operators, a joint analysis of \mathcal{O}_{y_t} and \mathcal{O}_{y_b} will yield a significantly different result comparing to individual operator analysis. A joint analysis for these two operators in terms of Yukawa coupling strengths and the associated CP phases is performed at CEPC. The important physics cases for such considerations are highlighted.

In Figure 11.13 constraints on the top and bottom Yukawa coupling strengths and their CP phases are presented in the left panel and right panel, respectively. The 68% and 95% exclusion bands are shown in solid and dashed lines. The limits for CEPC are shown in *bright* black and magenta lines for individual operator analysis and the *bright* green and yellow shaded regions representing the 68% and 95% allowed parameter space, respectively. The *dimmed* thick black curves represent the results after turning on both operators \mathcal{O}_{tH} and \mathcal{O}_{bH} at the same time, using a profile-likelihood method profiling over other parameters. Furthermore, in the left panel the cyan band represents constraints from HL-

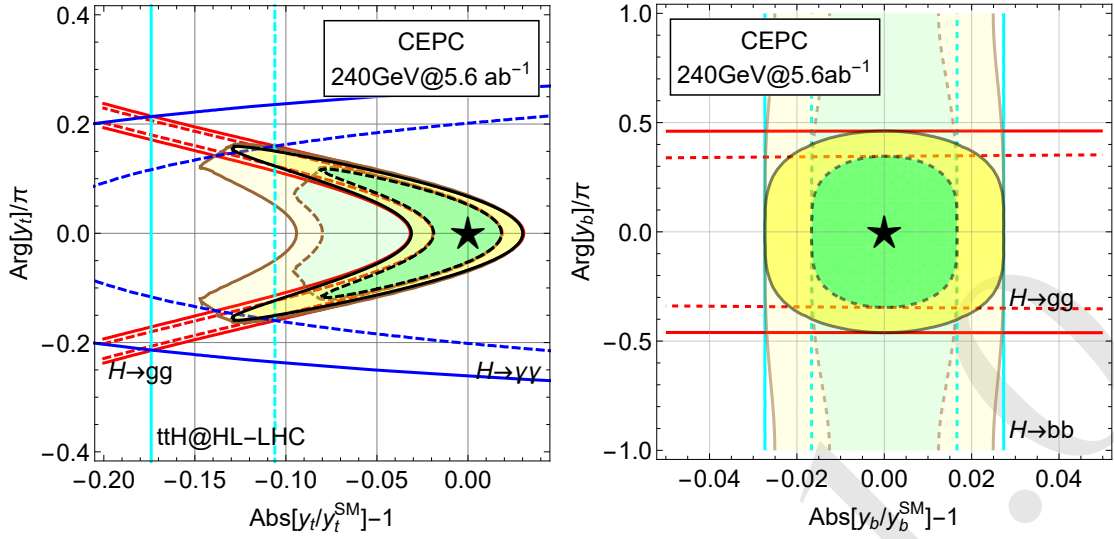

Figure 11.13: Results for analysis on C_{y_t} and C_{y_b} in the projected allowed regions for modification to top and bottom Yukawa couplings in magnitude and CP phase at 68% and 95% confidence level. The combined results for CEPC are shown in black curves. The source of individual constraints for the single operator analysis are labeled correspondingly. For a joint analysis of simultaneous appearance of both \mathcal{O}_{y_t} and \mathcal{O}_{y_b} operators, the results for CEPC are shown in the enlarged yellow (95%) and green regions (68%) with thick brown boundary lines.

1 LHC $t\bar{t}H$ measurements, red bands are constraints from CEPC $H \rightarrow gg$ measurements
 2 and blue bands are constraints from CEPC $H \rightarrow \gamma\gamma$ measurements. Similarly in the right
 3 panel, the cyan bands are constraints from $H \rightarrow b\bar{b}$ and the red bands are constraints from
 4 $H \rightarrow gg$ at CEPC.

5 The left panel of Figure 11.13 shows that the expected sensitivity on the modification
 6 in the magnitude of top Yukawa is at around $\pm 3\%$ for the single operator analysis, which
 7 is relaxed to $[-9.5\%, +3\%]$ for the joint analysis allowing the bottom Yukawa and the
 8 associated CP phase to vary freely, in the case of zero CP phase in the top Yukawa. The
 9 phase of the top Yukawa could be constrained to be $\pm 0.16\pi$. The constraints on the phase
 10 of the top Yukawa is driven by the $H \rightarrow \gamma\gamma$ measurements, where a sizable phase shift
 11 will enlarge the Higgs boson to diphoton rate via reducing the interference with SM W -
 12 loop. The constraints on the magnitude of the top Yukawa modification is driven by the
 13 $H \rightarrow gg$ measurements due to the dominant contribution to $H \rightarrow gg$ being from top-loop.
 14 Note that constraints from $H \rightarrow gg$ measurement is not entirely vertical, this is a result
 15 of the different sizes of the top-loop contribution to Hgg through scalar and pseudoscalar
 16 couplings. Similarly, as shown in the right panel of Figure 11.13 for the bottom Yukawa
 17 magnitude modification, the constraint is $\pm 2.5\%$ and, for the bottom Yukawa CP phase,
 18 the constraints changes from $\pm 0.47\pi$ to no constraint for simultaneous modification to top
 19 Yukawa.

20 11.1.8 Tests of Higgs boson spin/ CP

21 The CP parity of a Higgs boson, and more generally its anomalous couplings to gauge
 22 bosons in the presence of BSM physics, can be measured at the CEPC based on the
 23 $e^+e^- \rightarrow Z^* \rightarrow ZH \rightarrow \mu^+\mu^-b\bar{b}$ process. It is convenient to express the anomalous cou-

pling measurements in terms of physical quantities of effective fractions of events of the anomalous contribution relative to the SM predictions as detailed in Refs. [82–84], which are invariant under independent re-scalings of all couplings.

Two of the anomalous HZZ coupling measurements are of particular interest at the CEPC: the fraction of the high-order CP -even contribution due to either SM contribution or new physics, f_{a2} , and the fraction of a CP -odd contribution due to new physics, f_{a3} . The following two types of observables can be used to measure these anomalous couplings of the Higgs bosons.

1. The dependence of the $e^+e^- \rightarrow Z^* \rightarrow ZH$ cross section on \sqrt{s} is different for different CP property of the Higgs boson [84]. Therefore, measurements of the cross section at several different energies will yield useful information about anomalous HZZ couplings. However this has non-trivial implications to the accelerator design and is not included in this study as a single value of \sqrt{s} is assumed for the CEPC operating as a Higgs boson factory.
2. Angular distributions, $\cos \theta_1$ or $\cos \theta_2$ and Φ as defined in Figure 11.14. These angles are also sensitive to interference between CP -even and CP -odd couplings. In particular forward-backward asymmetry with respect to $\cos \theta_1$ or $\cos \theta_2$ and non-trivial phase in the Φ distributions can lead to an unambiguous interpretation of CP violation.

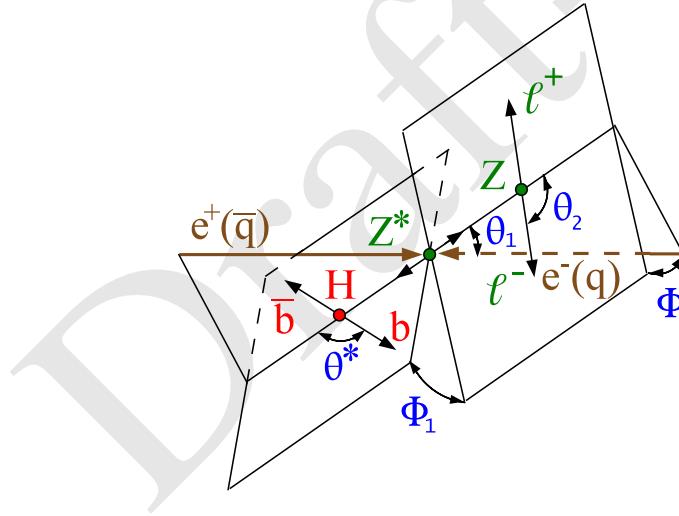

Figure 11.14: Higgs boson production and decay angles of the $e^+e^- \rightarrow Z^* \rightarrow ZH \rightarrow \mu^+\mu^-b\bar{b}$ process.

To estimate the sensitivities on the anomalous couplings, a maximum likelihood fit [84] is performed to match observed three-dimensional angular distributions to theory predictions including signal and background processes. In this likelihood fit, the signal probability density functions are from analytical predictions that are validated using a dedicated MC program, the JHU generator [82, 83], which incorporates all the anomalous couplings, spin correlations, interference of all contributing amplitudes. The background probability density function is modeled from simulation based on $e^+e^- \rightarrow ZZ \rightarrow e^+e^-b\bar{b}$ process in Madgraph [85].

Several thousand statistically-independent experiments are generated and fitted to estimate the sensitivity to f_{a2} and f_{a3} , defined as the smallest values that can be measured

with 3σ away from 0. All other parameters in the fit, including the number of expected signal and background events, are fixed. Figure 11.15 shows precision on f_{a2} and f_{a3} obtained with generated experiments. The expected sensitivity on f_{a2} and f_{a3} are 0.018 and 0.007 respectively.

The sensitivities of f_{a2} and f_{a3} are then converted to the equivalent parameters defined for the on-shell $H \rightarrow ZZ^*$ decays, f_{a2}^{dec} and f_{a3}^{dec} , in order to compare with the sensitivities from the LHC experiments as described in Ref. [84]. The corresponding sensitivities of f_{a2}^{dec} and f_{a3}^{dec} are 2×10^{-4} and 1.3×10^{-4} respectively. The much smaller values in the $f_{a2,a3}^{\text{dec}}$ are due to the much smaller $m_{Z^*}^2$ in the $H \rightarrow ZZ^*$ decay compared to the value in the $Z^* \rightarrow ZH$ production. A simultaneous fit of f_{a2} and f_{a3} can also be performed with the 68% and 95% confidence level contours shown in Figure 11.15.

Compared to the ultimate sensitivity of HL-LHC as shown in Ref. [84], the sensitivities in the f_{a2} and f_{a3} at the CEPC are a factor of 300 and 3 better. Further improvements can be achieved by exploring kinematics in the $H \rightarrow b\bar{b}$ decays, including other Z decay final states, and combining with the overall cross-section dependence of the signal with a threshold scan in \sqrt{s} .

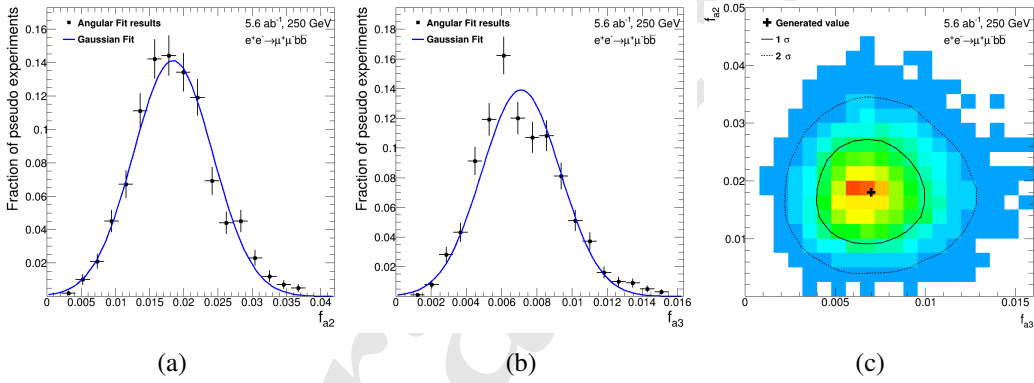

Figure 11.15: Distributions of fitted values of (a) f_{a2} and (b) f_{a3} in a large number of generated experiments. Only the parameter shown is floated in these fits. Other parameters are fixed to their SM expectations. (c) Simultaneous fit of non-zero f_{a2} and f_{a3} , with 68% and 95% confidence level contours shown.

11.1.9 Summary

Many new physics models predict Higgs boson coupling deviations at the sub-percent level, beyond those achievable at the LHC. The CEPC complements the LHC and will be able to study the properties of the Higgs boson in great details with unprecedented precision. At the CEPC, most of Higgs boson couplings can be measured with precision at a percent level or better, in particular the coupling to the Z boson can be determined with a precision of 0.25%. More importantly, the CEPC will be able to measure many of the key Higgs boson properties such as the total width and decay branching ratios model independently, greatly enhancing the coverage of new physics searches. Furthermore, the clean event environment of the CEPC will allow the identification of potential unknown decay modes that are impractical at the LHC.

This section provides a snapshot of the current studies, many of them are ongoing and more analyses are needed to fully understand the physics potential of the CEPC.

1 Nevertheless, the results presented here have already built a strong case for the CEPC as a
 2 Higgs factory. The CEPC has the potential to “undress” the Higgs boson as what the LEP
 3 has done to the Z boson, and potentially shed light on new physics.

4 11.2 W and Z Boson Physics

5 With high production cross sections and large integrated luminosity, the CEPC will reach
 6 a new level of precision for the measurements of the properties of the W and Z bosons.
 7 Precise measurements of the W and Z boson masses, widths, and couplings are critical
 8 to test the consistency of the SM [86]. In addition, many BSM models predict new cou-
 9 plings of the W and Z bosons to other elementary particles. Precise electroweak (EW)
 10 measurements performed at the CEPC could discover deviations from the SM predictions
 11 and reveal the existence of new particles that are beyond the reaches of direct searches at
 12 the current experiments.

13 Significant improvements are expected from the CEPC measurements. Table 11.9
 14 lists the expected precision from CEPC compared to achieved precision from the LEP
 15 experiments for various measurements. Details about the estimation of these uncertainties
 16 are described in this section.

Observable	LEP precision	CEPC precision	CEPC runs	CEPC $\int \mathcal{L} dt$
m_Z	2 MeV	0.5 MeV	Z pole	8 ab ⁻¹
$A_{FB}^{0,b}$	1.7%	0.1%	Z pole	8 ab ⁻¹
$A_{FB}^{0,\mu}$	7.7%	0.3%	Z pole	8 ab ⁻¹
$A_{FB}^{0,e}$	17%	0.5%	Z pole	8 ab ⁻¹
$\sin^2 \theta_W^{\text{eff}}$	0.07%	0.001%	Z pole	8 ab ⁻¹
R_b	0.3%	0.02%	Z pole	8 ab ⁻¹
R_μ	0.2%	0.01%	Z pole	8 ab ⁻¹
N_ν	1.7%	0.05%	ZH runs	5.6 ab ⁻¹
m_W	33 MeV	2-3 MeV	ZH runs	5.6 ab ⁻¹
m_W	33 MeV	1 MeV	WW threshold	2.6 ab ⁻¹

Table 11.9: The expected precision in a selected set of EW precision measurements in CEPC and the comparison with the precision from LEP experiments. The CEPC accelerator running mode and total integrated luminosity expected for each measurement are also listed.

17 11.2.1 Z pole measurements

18 The CEPC offers the possibility of dedicated low-energy runs at the Z pole for at least two
 19 years with a high instantaneous luminosity ($1.6 \times 10^{35} \text{ cm}^{-2} \text{ s}^{-1}$). The expected integrated
 20 luminosity for CEPC Z pole runs is more than 8 ab⁻¹, and it is expected to produce about
 21 3×10^{11} Z bosons.

22 These runs allow high precision electroweak measurements of the Z boson proper-
 23 ties, such as mass, total width and partial widths, e.g. the parameters $R_b = \Gamma_{Z \rightarrow b\bar{b}} / \Gamma_{\text{had}}$

and $R_\ell = \Gamma_{\text{had}}/\Gamma_{Z \rightarrow \ell\bar{\ell}}$.⁷ It would also perform high precision measurements of the forward-backward charge asymmetry (A_{FB}), the effective weak mixing angle ($\sin^2 \theta_W^{\text{eff}}$), number of light neutrino species (N_ν), and the mass of the Z boson (m_Z). It is also possible to perform some measurements with the Z boson without these dedicated low-energy runs near or at the Z pole. For example, the direct measurement of the number of light neutrino species can be performed in ZH runs at 240 GeV.

11.2.1.1 Z mass and width measurements

The mass m_Z , together with its total width Γ_Z , is a fundamental parameter in the SM and was determined with an overall uncertainty of 2 MeV by four LEP experiments. The lineshape scan around the Z peak was performed from 87.9 GeV to 94.3 GeV. The Z mass and widths were measured by a combined fit to the hadronic and leptonic cross sections in the on-peak and off-peak datasets. Most of the m_Z information is extracted from the off-peak runs. Taking the OPAL measurement as one example, six off-peak datasets were used to complete the m_Z scan. The main uncertainty of m_Z includes the statistical uncertainty (1 MeV), and the LEP beam energy (about 1 MeV).

\sqrt{s} (GeV)	Luminosity (ab^{-1})
87.9	0.25
90.2	0.25
91.2	7
92.2	0.25
94.3	0.25

Table 11.10: The proposed five $e^+e^- \rightarrow Z$ threshold scan runs and their integrated luminosity, for a total integrated luminosity of 8 ab^{-1} .

A precision of 0.5 MeV in m_Z and Γ_Z can be achieved in CEPC measurement. The lineshape scan around the Z peak is the key for improving m_Z measurements. The LEP measurement was limited by the statistics in their off-peak runs, therefore the luminosity in Z off-peak runs plays an important role in the m_Z measurement. We propose four off-peak runs and one on-peak run in CEPC Z mass scan, as listed in Table 11.10. The expected m_Z uncertainty in CEPC due to statistics is below 0.1 MeV.

The major systematic uncertainty is beam momentum scale uncertainty. The beam momentum is expected to be measured by depolarizing resonance method, which was developed by LEP [87]. The beam momentum uncertainty in the CEPC accelerator is expected to be less than 0.5 MeV. The uncertainty in luminosity measurement is expected to be the sub-leading systematic uncertainty. As described in Section 9.4.2, this uncertainty is about 0.05% level, corresponding to about 0.1 MeV uncertainty in Z mass measurement.

Z threshold scan is also needed for Z lineshape studies. The lineshape is strongly affected by the emission of initial state photon radiation (ISR), with a shift of the peak position by about 100 MeV and a decrease of the cross section by about 25%. Moreover

⁷Here R_ℓ is defined as the ratio to any *one* charged lepton flavor, assuming lepton universality, not the ratio to the sum of all lepton flavors.

1 the emission of ISR creates a distortion of the shape with respect to a Breit-Wigner form,
 2 with the appearance of a typical radiative tail for $\sqrt{s} \sim 93$ GeV. An efficient way to
 3 account for ISR is to convolute a QED radiator function with the kernel cross section $\hat{\sigma}$
 4 evaluated at the proper reduced center of mass energy, according to

$$\sigma(s) = \int_{z_0}^1 dz H(z; s) \hat{\sigma}(zs), \quad (11.16)$$

5 where z_0 depends on the event selection. The radiator function is known at $\mathcal{O}(\alpha^2)$ and
 6 including leading terms of $\mathcal{O}(\alpha^3 L^3)$ [88, 89], where $L = \log(s/m_e^2)$. Such calculations
 7 have been implemented in two independent codes, TOPAZO [90–93] and ZFITTER [94–
 8 96], used to estimate the impact of the residual QED uncertainty on Z mass and width
 9 at the level of 0.1 MeV [97–99]. The uncertainty on the cross sections due to QED was
 10 estimated below the 0.01% level. The kernel cross section in the SM is composed of
 11 three contributions: Z exchange, γ exchange and their interference, which are calculated
 12 perturbatively with NLO precision supplemented with higher order terms from running
 13 couplings and QCD corrections, which guarantees a theoretical uncertainty on observables
 14 at the 0.01% level. Aiming at a model-independent parameterization of the Z lineshape
 15 around the Z resonance [100], the Z exchange contribution can be parametrized in the
 16 following way

$$\begin{aligned} \sigma_{f\bar{f}}^Z &= \sigma_{f\bar{f}}^{\text{peak}} \frac{s\Gamma_Z^2}{(s - m_Z)^2 + s^2\Gamma_Z^2/m_Z^2} \\ \sigma_{f\bar{f}}^{\text{peak}} &= \frac{\sigma_{f\bar{f}}^0}{R_{\text{QED}}}, \quad \sigma_{f\bar{f}}^0 = \frac{12\pi}{m_Z^2} \frac{\Gamma_{ee}\Gamma_{f\bar{f}}}{\Gamma_Z^2}, \end{aligned}$$

17 where R_{QED} removes the final state QED corrections. The two contributions which are
 18 not factorizable on the Z exchange are calculated in the SM, thus introducing a depen-
 19 dence on the SM parameters, such as the mass of the top quark, the Higgs boson mass and
 20 the strong coupling constant. The SM model parameter dependence has been estimated at
 21 the end of LEP1 operations to be below 0.1% level, which was the target precision. After
 22 subtraction of the non-factorizable terms, the resonance parameters are extracted from the
 23 lineshape data by means of a global fit. In particular, assuming lepton universality, four
 24 quantities are extracted from the fit: m_Z , Γ_Z , R_ℓ and the hadronic peak cross section σ_h .
 25 The Z resonance parameter measurements can be directly compared with SM predictions.
 26 The latter have been completed very recently at complete two-loop electroweak accu-
 27 racy, including corrections due to the top-quark Yukawa coupling up to $\mathcal{O}(\alpha_t^3)$ and mixed
 28 $\mathcal{O}(\alpha\alpha_s)$ and $\mathcal{O}(\alpha_t\alpha_s^n)$ contributions with $n = 2, 3$ and $\mathcal{O}(\alpha_t^2\alpha_s)$ terms (see Ref. [101]).
 29 This level of perturbative knowledge guarantees remaining theoretical uncertainties in the
 30 range 0.005%-0.05% for the various Z resonance parameters (including ratios of par-
 31 tial widths), which is, depending on the quantity, comparable or slightly larger than the
 32 projected experimental precision discussed in the following sections. Further theoretical
 33 efforts would be needed to obtain negligible theoretical systematic uncertainties.

34 An alternative, more model independent, approach to fit the Z lineshape data is the
 35 one proposed in Refs. [102–104], where the Z - γ interference is obtained by fitting ad-
 36 ditional parameters, j_Z^i (one for each measured $f\bar{f}$ channel), to off-peak data. At CEPC
 37 this method could be adopted at the ZH and WW threshold runs. Similar measurements
 38 were performed at LEP2 for the hadronic parameter j_Z^{had} , even if limited by the available
 39 statistics [105–108].

11.2.1.2 R_b

The partial width of the Z boson to its individual decay channel is proportional to the square of the fundamental Z -fermion couplings. The ratio of the partial widths R_b is sensitive to electroweak radiative corrections from new particles. For example, the existence of the scalar top quarks or charginos in supersymmetry could lead to a visible change of R_b from the SM prediction.

Precise measurements of R_b have been made by LEP collaborations [109–113] and by the SLD collaboration [114] using hadronic Z events.

Decays of b -hadrons were tagged using tracks with large impact parameters and/or reconstructed secondary vertices, complemented by event shape variables. The combination of LEP and SLD measurements yields a value of 0.21629 ± 0.00066 for R_b . The relative statistical uncertainty of R_b is above 0.2%, and systematic uncertainty is about 0.2%.

A relative precision of 0.02% can be achieved for the measurement of R_b at the CEPC, and it will improve the current precision in experimental measurement by one order of magnitude. The main systematic uncertainty is due to hemisphere tag correlations in $Z \rightarrow b\bar{b}$ events (0.02%). The uncertainty due to hemisphere tag correlations can be reduced to a level of 0.02% from the expected improvement in the b -tagging performance of the CEPC detector. The improvement of b -tagging efficiency is the key to reduce this uncertainty, and this uncertainty becomes irrelevant in the limit of 100% b -tagging efficiency. Due to that fact that a next-generation vertex detector will be used in the CEPC detector, the b -tagging efficiency is expected to be around 70% with a b -jet purity of 95% as shown in Figure 10.13, which is about 15%–20% higher than the efficiency achieved in previous experiments. The uncertainty due to hemisphere tag correlations can be reduced to 0.02% level, which is a factor of ten lower than previous measurements.

11.2.1.3 The partial decay width of $Z \rightarrow \mu^+\mu^-$

The $\mu^+\mu^-$ channel provides the cleanest leptonic final state. Combining the measurements from all four LEP experiments [115–118], the overall uncertainty of R_μ is 0.2%. The statistical uncertainty of R_μ is about 0.15%.

A precision of 0.01% can be achieved at the CEPC. The main systematic is expected to be the uncertainty in modeling the $Z \rightarrow \mu^+\mu^-\gamma$ events. About 2% of the $Z \rightarrow \mu^+\mu^-$ sample are classified as $Z \rightarrow \mu^+\mu^-\gamma$ events with a photon detected in ECAL. For this class of events, the most critical issue is to reconstruct and identify the low energy photon object with high efficiency. Benefiting from high granularity of CEPC EM calorimeter ($10 \times 10 \text{ mm}^2$ as shown in Chapter 5), we expect to have close to 100% efficiency for photon with $E > 5 \text{ GeV}$ as shown in Section 10.2.2. Another challenge in this measurement is to reduce the systematics due to QED ISR events. Detailed studies of radiative events in Z off-peak runs are expected, especially the Z off-peak runs at $\sqrt{s} = 92.2 \text{ GeV}$. Benefiting from high statistics in Z off-peak runs ($> 1 \text{ ab}^{-1}$), the uncertainty in the modeling uncertainty of $Z \rightarrow \mu^+\mu^-\gamma$ events can be reduced to a level of 0.01%.

11.2.1.4 Forward-backward asymmetry measurements at the Z pole

Another important class of measurements for the study of the chiral couplings of the Z boson to fermions is given by the forward-backward asymmetries in the processes

1 $e^+e^- \rightarrow f\bar{f}$,

$$A_{FB} = \frac{\sigma_F - \sigma_L}{\sigma_L + \sigma_R}, \quad (11.17)$$

2 which are optimal observables to quantify the parity violation of neutral currents. In fact,
3 the differential tree-level cross section at the Z peak, for unpolarized incoming beams and
4 including only the Z exchange contribution, can be written as

$$\frac{d\sigma_{f\bar{f}}}{d\cos\vartheta} = \frac{3}{8}\sigma^{tot} [1 + \cos^2\vartheta + 2\mathcal{A}_e\mathcal{A}_f \cos\vartheta], \quad (11.18)$$

5 where the coefficients \mathcal{A}_i can be expressed in terms of the left/right couplings $g_{L/R,i}$ or the
6 vectorial and axial-vector couplings g_V^i and g_A^i :

$$\mathcal{A}_f = \frac{g_{L,f}^2 - g_{R,f}^2}{g_{L,f}^2 + g_{R,f}^2} = \frac{2g_V^f g_A^f}{(g_V^f)^2 + (g_A^f)^2} = \frac{\frac{g_V^f}{g_A^f}}{1 + \left(\frac{g_V^f}{g_A^f}\right)^2} \quad (11.19)$$

7 In particular the last expression of Eq. 11.19 shows that the observable A_{FB} gives an
8 information complementary to the partial widths, which are proportional to the combina-
9 tion $(g_V^f)^2 + (g_A^f)^2$, giving access to the linear ratio g_V^f/g_A^f . The same expression is used
10 to define the parameter $\sin^2\vartheta_{\text{eff}}^f$

$$4|Q_f| \sin^2\vartheta_{\text{eff}}^f = 1 - \frac{g_V^f}{g_A^f}, \quad (11.20)$$

11 which, at tree-level, coincides with $1 - (M_W/M_Z)^2$. The relation between A_{FB} and \mathcal{A}_i at
12 the Z pole, for unpolarized beams, is the following:

$$A_{FB}^{0,f} = \frac{3}{4}\mathcal{A}_e\mathcal{A}_f. \quad (11.21)$$

13 Since $\sin^2\vartheta_{\text{eff}} \sim 1/4$, \mathcal{A}_i is close to 0.1 for leptons while for quarks $\mathcal{A}_u \sim 0.7$ and $\mathcal{A}_d \sim$
14 0.9. This, associated to the fact that the asymmetry measurements at LEP were limited
15 by statistics, implied that $A_{FB}^{0,b}$ offered the most precise determination of $\sin^2\vartheta_{\text{eff}}$. The
16 measurements have been made at SLD and LEP experiments [119–123]. $Z \rightarrow b\bar{b}$ events
17 were identified by tagging two b jets. Each event was divided into forward and backward
18 categories by the plane perpendicular to the thrust axis which contains the interaction
19 point. The combination of the LEP and SLD measurements gives a measured value of
20 $A_{FB}^{b,0} = 0.1000 \pm 0.0017$. The statistical uncertainty is 1.2% and the main systematic
21 uncertainties come from hemisphere tag correlations for b events (1.2%) and QCD and
22 thrust axis correction (0.7%).

23 A precision of 10^{-4} can be achieved for the measurement of $A_{FB}^{0,b}$ at the CEPC,
24 improving the current precision by more than a factor of 10. The expected statistical
25 uncertainty is at a level of 0.01%. The uncertainty due to hemisphere tag correlations for
26 b events can be reduced to 0.1% due to excellent b -tagging performing in CEPC vertex
27 detector. By selecting events with back-to-back jets event topology, the uncertainty on
28 thrust axis definition due to QCD higher correlations can be reduced down to less than
29 0.1%.

The expected precision of the effective weak mixing angle measurement in CEPC using $Z \rightarrow b\bar{b}$ events is expected to be 0.02%. The theory uncertainty of the SM prediction is below the 0.01% threshold, thanks to the recent complete two-loop electroweak calculation of Ref. [124].

The energy dependence of the asymmetries around the Z resonance is sensitive to the interference between Z and γ exchange. It allows to measure the values of the axial-vector couplings.

11.2.1.5 Neutrino species counting

Two different methods have been used to determine the number of light neutrino species (N_ν) at LEP. The first one is the indirect method using the analysis of the Z lineshape, and it uses the data collected by the Z threshold scan runs. The Z peak scan at CEPC can improve the LEP determination of N_ν by a factor of three. The second method is a direct measurement, which is based on the measurement of the cross section for the radiative process $e^+e^- \rightarrow \nu\nu\gamma$. The second method at CEPC is supposed to use the ZH runs and improve the LEP direct determination by a factor of ten.

The systematic uncertainties of theoretical origin associated with the two methods are completely different: the indirect one relies on the precision calculation of the Z partial decay widths, while the direct one needs the calculation of higher order radiative corrections for the process $e^+e^- \rightarrow \nu\bar{\nu}\gamma$. Moreover the two methods use completely different datasets, therefore they are independent and complementary. The sensitivity to new physics will be different for these two methods. In the direct method, one can measure N_ν as a function of \sqrt{s} . A deviation of N_ν from an integer value would signal the presence of new physics. Possible contributions include WIMP dark matter particles, and other weakly coupled particles such as exotic neutrinos, gravitinos, or KK gravitons in theories with large extra dimensions. Thus, when we refer to the number of neutrino species, we actually include any number of possible invisible particles other than neutrinos. The sub-process $e^+e^- \rightarrow \nu_e\bar{\nu}_e\gamma$ is particularly important because it will allow to investigate possible deviations with respect to the SM in the vertex γW^+W^- , in a complementary way with respect to the W^+W^- production cross section, where both γW^+W^- and ZW^+W^- vertices appear in the matrix element.

Indirect method from Z line shape The indirect method assumes all contributions from invisible channels are coming from the $Z \rightarrow \nu\bar{\nu}$ decay, assuming that the total Z width does not receive additional contribution with respect to the SM ones. This method used the analysis of Z lineshape, subtracting the visible partial widths of the hadrons (Γ_{had}), and the partial widths of the leptons (Γ_ℓ) from the total width Γ_Z . The invisible width Γ_{inv} can be written as:

$$\Gamma_{\text{inv}} = N_\nu \Gamma_\nu = \Gamma_Z - \Gamma_{\text{had}} - 3\Gamma_\ell. \quad (11.22)$$

We take as our definition of the number of neutrinos $N_\nu = \Gamma_{\text{inv}}/\Gamma_\nu$, i.e. the ratio of the invisible width to the Standard Model expectation for the partial width to a single neutrino species.

Using the input from SM model, we can rewrite equation 11.22 as follows:

$$N_\nu = \frac{\Gamma_\ell}{\Gamma_\nu} \left(\sqrt{\frac{12\pi R_\ell}{m_Z^2 \sigma_{\text{had}}^0}} - R_\ell - 3 \right). \quad (11.23)$$

The final LEP1 result was $N_\nu = 2.9840 \pm 0.0082$ [125]. As shown in equation 11.23, the precision of N_ν depends on the the lepton partial width R_ℓ measurement, the Z mass measurement, and the hadronic cross section of the Z boson on its mass peak (σ_{had}^0). The decomposition of the error on N_ν is given by [125]

$$\delta N_\nu \simeq 10.5 \frac{\delta n_{\text{had}}}{n_{\text{had}}} \oplus 3.0 \frac{\delta n_{\text{lep}}}{n_{\text{lep}}} \oplus 7.5 \frac{\delta \mathcal{L}}{\mathcal{L}}, \quad (11.24)$$

where $\delta n_{\text{had}}/n_{\text{had}}$, $\delta n_{\text{lep}}/n_{\text{lep}}$ and $\delta \mathcal{L}/\mathcal{L}$ represent the total errors on the number of selected hadronic and leptonic events and on the luminosity determination. The symbol \oplus denotes the sum in quadrature. The final theoretical uncertainty of 0.061% [126] (0.054% [127, 128]), available at the end of LEP operation [125] for the small angle Bhabha process, reflects in a systematic uncertainty of 0.15%, i.e. $\sim 50\%$ of the total uncertainty of 0.27%, on N_ν .

The precision of 0.1% in N_ν measurement with the indirect method can be achieved in CEPC measurement, which improves the current precision by a factor of three. Benefiting from the recent development of luminosity detector technology, the uncertainty due to luminosity can be reduced to 0.05%. The theoretical uncertainty of predictions for the small angle Bhabha process can be reduced, conservatively, to 0.05% or below, mainly due to the recent progress in the evaluation of the hadronic contribution to the photon vacuum polarization [129–131]. This uncertainty can be pushed down even further, close to the 0.01% scale, once the NNLO QED predictions are matched to higher order soft/collinear contributions.

Direct method using $e^+e^- \rightarrow \nu\bar{\nu}\gamma$ events The direct method is based on the process $e^+e^- \rightarrow \nu\bar{\nu}\gamma$, whose cross section is proportional to N_ν , with the typical signature in the detector of only one photon with energy $E_\gamma = (s - m_Z^2)/(2\sqrt{s})$. The most precise direct N_ν measurements at LEP were carried out by the L3 collaboration and Delphi collaboration. By combining the direct measurements at LEP, the current experimental result is $N_\nu = 2.92 \pm 0.04$. The statistical uncertainty of N_ν in the previous measurement is 1.7%. The main systematic uncertainty from the L3 measurement includes the uncertainty in single photon trigger efficiency (0.6%), and photon identification efficiency (0.3%), and the uncertainty in identifying the converted photons (0.5%). The systematic uncertainty of theoretical origin is due to the knowledge of higher order radiative corrections to the process $e^+e^- \rightarrow \nu\bar{\nu}\gamma$, within the SM. At LEP an uncertainty at the percent level was achieved through complete tree-level matrix elements for $e^+e^- \rightarrow \nu\bar{\nu}\gamma$ and $e^+e^- \rightarrow \nu\bar{\nu}\gamma\gamma$, properly combined with higher orders initial state multiphoton radiation [132]. The bulk of the electroweak corrections were accounted for through running couplings on top of the tree-level matrix elements or through $\mathcal{O}(\alpha)$ corrections to $Z\gamma$ production [132–137]. A first calculation including one-loop electroweak corrections appeared in Ref. [138], with an estimated uncertainty of the order of 1%

An overall precision of 0.2% can be achieved for the direct measurement of N_ν at CEPC, and it will improve the current precision by a factor of 10. Due to the excellent performance of the CEPC inner tracker, the uncertainty due to converted photons' selection efficiency is expected to be negligible. The granularity of the CEPC EM calorimeter is expected to be 10 to 100 times better than the detectors at LEP. Therefore photons can be identified with high purity with loose EM shower shape based selection. The uncertainty of photon efficiency can be reduced to less than 0.05%. On the theoretical side, the con-

1 trol of electroweak corrections should be moved to the two-loop level, in addition to the
 2 matching to higher order QED corrections. Given the recent progress in the calculation of
 3 NNLO corrections for $2 \rightarrow 3$ processes at the LHC, the program looks feasible. It would
 4 be also worth to investigate the ratio $\sigma(e^+e^- \rightarrow \nu\bar{\nu}\gamma)/\sigma(e^+e^- \rightarrow \mu^+\mu^-\gamma)$, where (large)
 5 part of the ISR radiative corrections are expected to cancel, provided the luminosity allows
 6 enough statistics for the process $e^+e^- \rightarrow \mu^+\mu^-\gamma$.

7 11.2.2 Measurement of the W boson mass

8 In e^+e^- collisions, W bosons are mainly produced in pairs, through the reaction $e^+e^- \rightarrow$
 9 W^+W^- . At threshold, $\sqrt{s} \sim 2m_W$, the cross section of this process is very sensitive
 10 to m_W , providing a natural method for the measurement of this parameter. At center-of-
 11 mass energies above the W^+W^- production threshold, m_W can be determined from the
 12 peak of the invariant mass distribution of its decay products. Both methods are very com-
 13plementary : while the former requires an accurate theoretical prediction of the W^+W^-
 14 production cross section as a function of m_W and a precise determination of the col-
 15lider luminosity, the latter mostly relies on a good resolution in the reconstruction of the
 16 hadronic invariant mass, and a precise control of the detector calibration.

17 Both methods have been used at LEP. With only about 40 pb^{-1} collected by the four
 18 LEP experiments at $\sqrt{s} \sim 161.3 \text{ GeV}$ and given the low cross section at threshold, the
 19 former is limited by a significant statistical uncertainty of about 200 MeV. The final state
 20 reconstruction method exploited the full LEP2 dataset, about 2.6 fb^{-1} collected between
 21 $\sqrt{s} \sim 161.3 \text{ GeV}$ and 206 GeV, and achieved a total uncertainty of 33 MeV. While this
 22 measurement used both the $W^+W^- \rightarrow \ell\nu qq$ and $W^+W^- \rightarrow qqqq$ channels, the fully
 23 hadronic channel is limited by uncertainties in the modeling of hadronization and inter-
 24actions between the decaying W bosons, and the semi-leptonic final state dominates the
 25 precision of the final result.

26 Accounting for results from the CDF and D0 experiments at the TeVatron, and from
 27 ATLAS at the LHC, the present world-average value of m_W has an uncertainty estimated
 28 between 12 and 13 MeV. The uncertainty is expected to fall below 10 MeV when including
 29 final LHC measurement results. A natural goal for CEPC is thus to reach a precision well
 30 below 5 MeV, making optimal use of W^+W^- cross section data around $\sqrt{s} \sim 161 \text{ GeV}$,
 31 and of the final state invariant mass distributions at $\sqrt{s} \sim 240 \text{ GeV}$. The achievable preci-
 32sion of both methods is described below.

33 Determination of m_W and Γ_W from the W^+W^- production cross section

34 In this section, the possibility of extracting the W boson mass and width from the pro-
 35 duction cross section is explored. The study assumes a total integrated luminosity of
 36 $L = 3.2 \text{ ab}^{-1}$, which can be collected in one year, assuming an instantaneous luminosity
 37 of 2.5 ab^{-1} . For this study, the GENTLE program version 2.0 [?] is used to calculate
 38 $\sigma_{W^+W^-}$ as a function of the center-of-mass energy, m_W and Γ_W . The behavior of the
 39 cross section as a function of the center-of-mass energy, \sqrt{s} , is illustrated in Figure 11.16.

40 The statistical sensitivity of the measurement is optimized in the following way:

- 41 ▪ the total integrated luminosity is shared between one, two or three values of \sqrt{s} ;
- 42 ▪ in the two-point scenario, a three-dimensional optimization is performed, scanning
- 43 both values \sqrt{s} in steps of 100 MeV, and the fraction of integrated luminosity spent
- 44 at each point in steps of 5%;

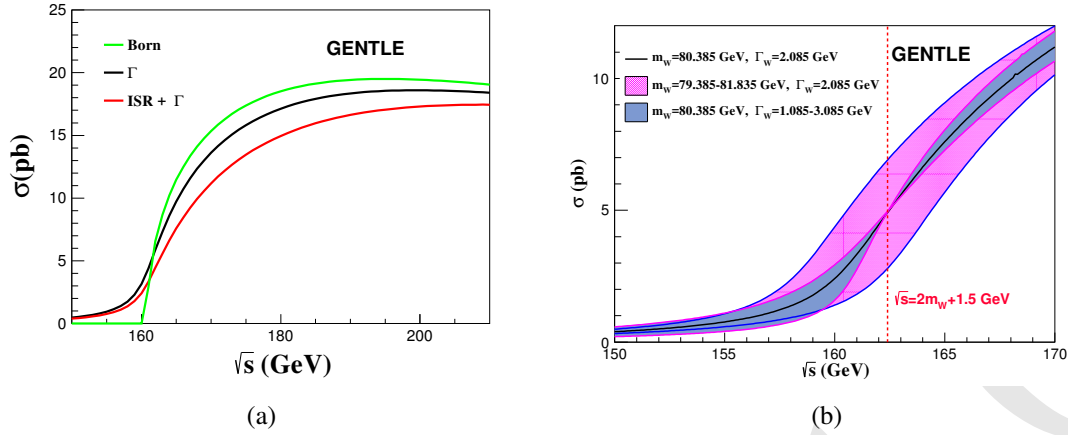

Figure 11.16: W^+W^- production as a function of \sqrt{s} , (a) at Born level, including finite width effects, and including initial state radiation corrections; and (b) for a range of values of m_W and Γ_W .

- 1 ▪ in the three point scenario, a corresponding five-dimensional optimization is per-
2 formed.

3 Sources of systematic uncertainties can be categorized as correlated or uncorrelated
4 between measurements at different values of \sqrt{s} . The following sources are considered:

- 5 ▪ Uncorrelated sources: this category includes the uncertainties associated with the
6 beam energy calibration, and the beam energy spread. For the former, an uncertainty
7 of 0.5 MeV is assumed, and the latter can be controlled to 1%, at each value of \sqrt{s} ;
- 8 ▪ Correlated sources: this category includes the uncertainties from the integrated lumi-
9 nosity, the detection efficiency, the purity, and the theoretical W-pair cross section. It
10 is assumed that these sources sum up to a total relative uncertainty of 2×10^{-4} on the
11 ratio between measured and predicted cross sections.

12 The result of the statistical optimization leads to a three-point scenario, with most of
13 the data collected at energies of 157.5 and 162.5 GeV. Another run at energy of 172 GeV
14 is also needed for $\alpha_S(m_W)$ measurement. A summary of given in Table 11.11. The final
15 measurement uncertainties, assuming this optimal scenario and systematic uncertainties
16 are described above, are collected in

17 Table 11.12. We conclude that an uncertainty of about 1 MeV can be achieved for
18 m_W , and 3 MeV for Γ_W . Both m_W and Γ_W are expected to be dominated by statistical
19 uncertainties. The major systematic uncertainty for m_W measurement is expected to be
20 the uncertainty in beam energy calibration, while the Γ_W measurement is significantly
21 affected by the beam energy spread.

22 Determination of m_W by kinematic reconstruction

23 According to LEP experience, the fully hadronic final state is limited by systematic uncer-
24 tainties that are difficult to control using data. The present section therefore concentrates
25 on the semi-leptonic final states, where one W boson decays to an electron or a muon,
26 while the other decays hadronically. An estimate of the m_W measurement potential is
27 presented based on $WW \rightarrow \ell\nu qq$ events ($\ell = e, \mu$), and the potential of hadronic Z boson
28 decays to calibrate the measurement of the hadronic invariant mass is evaluated.

\sqrt{s} (GeV)	Luminosity (ab^{-1})
157.5	0.5
161.5	0.2
162.5	1.3
172.0	0.6

Table 11.11: The proposed $e^+e^- \rightarrow W^+W^-$ threshold scan runs and their integrated luminosity, for a total integrated luminosity of 2.6 ab^{-1} .

Observable	m_W	Γ_W
Source	Uncertainty (MeV)	
Statistics	0.8	2.7
Beam energy	0.4	0.6
Beam spread	–	0.9
Corr. syst.	0.4	0.2
Total	1.0	2.8

Table 11.12: Dominant systematic uncertainties in the measurement of m_W and Γ_W , using the production cross section at threshold at CEPC.

The W^+W^- cross section at $\sqrt{s} = 240 \text{ GeV}$ is about 17 pb . For an integrated luminosity of 5.6 ab^{-1} , this corresponds to a sample of about 95×10^6 W boson pairs, and 28×10^6 $WW \rightarrow \ell\nu qq$ events. For ZZ production, the cross section is about 1 pb , yielding about 5.6×10^6 Z boson pairs, and 1.6×10^6 $ZZ \rightarrow \nu\nu qq$ events. While the Z boson mass is more precisely known than m_W and the $Z \rightarrow qq$ resonance provides a useful check of the detector calibration, the sample is small compared to the $W \rightarrow qq$ one, and the presence of heavy quarks in Z boson decays has to be accounted for when deriving constraints on the hadronic response in W events.

W^+W^- event selection criteria will require the presence of one reconstructed electron or muon with energy greater than 10 GeV , and missing transverse momentum greater than 10 GeV . The invariant mass of all reconstructed final state particles should exceed 50% of the center-of-mass energy; the hadronic system, *i.e.* the set of all particles excluding the selected lepton, is clustered into two jets and its invariant mass distribution is used to probe the W boson mass. A b -tag veto can be applied to enrich the selected samples in light-quark decays, and reduce the systematic differences between the W and Z boson samples. In the $\mu\nu qq$ channel, the efficiency of these criteria is 71.3% , as shown in Table 11.13. Corresponding selection efficiencies for $ZZ \rightarrow \nu\nu qq$ events are shown in Table 11.14. The corresponding hadronic invariant mass distributions are shown in Figure 11.17. After these selections, backgrounds are expected to be small and play a negligible role in the measurement.

Given the large expected statistics, the availability of the $e\nu qq$ channel and the good resolution in the invariant mass distribution, the statistical sensitivity of the m_W measure-

Selection	Efficiency (%)	Nb. of events
$E_\mu > 10 \text{ GeV}, \cos(\theta_\mu) < 0.995$	85.4	11.9×10^6
$p_T^{\text{miss}} > 10 \text{ GeV}$	82.0	11.5×10^6
$m_{\text{vis}} > 0.5 \times \sqrt{s}$	75.6	10.6×10^6
$b\text{-tag score} < 0.5$	71.3	10.0×10^6

Table 11.13: Efficiency of the event selection criteria in the $WW \rightarrow \mu\nu qq$ channel.

Selection	Efficiency (%)	Nb. of events
Missing Energy $> 35 \text{ GeV}$	69.9	1.12×10^6
$m_{\text{vis}} > 0.2 \times \sqrt{s}$	66.4	1.06×10^6
$b\text{-tag score} < 0.5$	50.1	0.80×10^6

Table 11.14: Efficiency of the event selection criteria in the $ZZ \rightarrow \nu\nu qq$ channel.

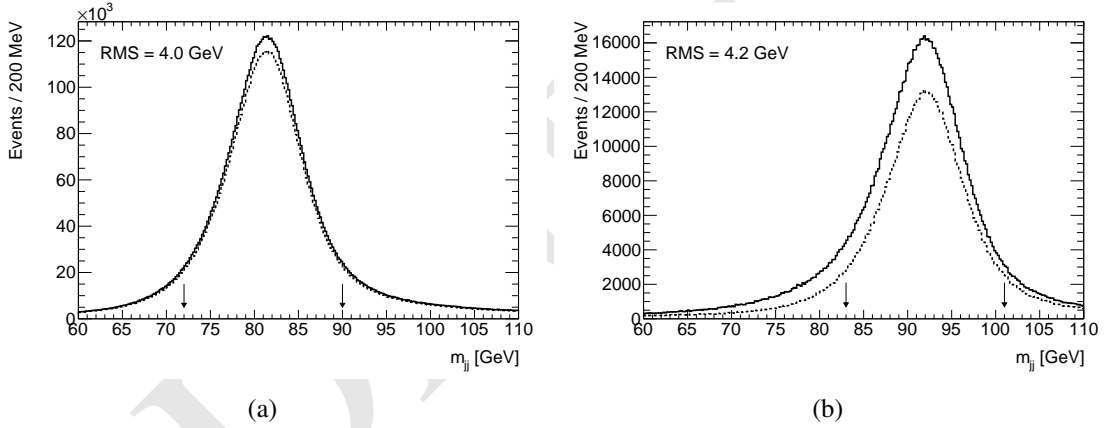

Figure 11.17: Dijet invariant mass distributions for (a) $WW \rightarrow \mu\nu qq$ events, without and with a b -jet veto cut, and correspondingly for (b) $ZZ \rightarrow \nu\nu qq$ events. The RMS of the distributions are quoted for the interval indicated by the arrows.

1 ment is better than 1 MeV. Using the $ZZ \rightarrow \nu\nu qq$ sample alone, the detector calibration
 2 can be checked to about 6 MeV. Further calibration samples can be extracted from radiative
 3 return events ($e^+e^- \rightarrow Z\gamma$). In addition, runs at $\sqrt{s} = 91.2 \text{ GeV}$ will be required for
 4 general detector alignment, monitoring and calibrations; these runs will provide copious
 5 samples of hadronic Z boson decays that will further constrain the hadronic calibration.
 6 Combining all information, the statistical precision of the calibration samples will match
 7 that of the W boson decays.

8 The statistical sensitivity can be further enhanced using kinematics fits, constrain-
 9 ing the reconstructed lepton and jet momenta to match the known center of mass energy
 10 ($\sum_i E_i = \sqrt{s}$) and total event momentum ($\sum_i \vec{p}_i = \vec{0}$). This method was routinely used at
 11 LEP, gaining a factor of about 3 in the statistical precision, at the expense of an explicit de-

pendence of the measurement on the beam energy. Given the expected statistical precision at CEPC, this refinement seems unnecessary here. In these conditions, the beam energy calibration, and initial state radiation are expected to contribute less than 1 MeV to the measurement uncertainty. Further significant sources of systematic uncertainty include the lepton momentum scale, which can be reduced using Z boson decays as discussed above, and the modeling of hadronization. The latter can be strongly reduced using measurements of rates and distributions of identified particles, in both Z and W boson decays.

The primary sources of uncertainty are summarized in Table 11.15, comparing LEP and CEPC. A total uncertainty at the level of 3 MeV seems reachable.

]

Collider	LEP	CEPC
\sqrt{s} (GeV)	180–203	240
$\int \mathcal{L} dt$	2.6 fb ⁻¹	5.6 ab ⁻¹
Channels	$\ell\nu qq, qq qq$	$\ell\nu qq$

Source	Uncertainty (MeV)	
Statistics	25	1.0
Beam energy	9	1.0
Hadronization	13	1.5
Radiative corrections	8	1.0
Detector effects	10	1.5
Total	33	3.0

Table 11.15: Dominant systematic uncertainties in the measurement of m_W using direct reconstruction, as achieved at LEP, and expected at CEPC.

11.2.3 Oblique Parameter

Using the estimated experimental capabilities of CEPC, we carry out a fit to determine the sensitivity of CEPC to the oblique electroweak parameters S and T [139, 140]. We omit the parameter U that is often included in fits as it arises from a dimension-8 operator in theories with a weakly coupled Higgs boson [141], and so is expected to be much smaller than S and T which arise at dimension 6. In the electroweak fit we treat the following five well-measured observables as parameters, from which the Standard Model prediction for all of the other observables may be computed:

$$\alpha_s(m_Z^2), \Delta\alpha_{\text{had}}^{(5)}(m_Z^2), m_Z, m_t, m_H. \tag{11.25}$$

Of these parameters, CEPC is expected to significantly improve our knowledge of m_Z . The primary power of CEPC is in improving the precision of measurements of other observables, including m_W and $\sin^2 \theta_{\text{eff}}^\ell$, which may be derived from these parameters. Readers interested in more background information may find a thorough and up-to-date review of the status of electroweak precision in Ref. [142].

Observable	Value	Exp. Uncertainty	Th. Uncertainty
$\alpha_s(M_Z^2)$	0.1185	1.0×10^{-4} [36]	1.5×10^{-4}
$\Delta\alpha_{\text{had}}^{(5)}(m_Z^2)$	276.5×10^{-4}	4.7×10^{-5} [143]	–
m_Z [GeV]	91.1875	0.0005	–
m_t [GeV] (pole)	173.34	0.6 [144]	0.25 [145]
m_H [GeV]	125.14	0.1 [143]	–
m_W [GeV]	80.358617 [146]	0.001	1.4×10^{-3}
$A_{\text{FB}}^{0,b}$	0.102971 [124, 147]	1.0×10^{-4}	8.3×10^{-5}
$A_{\text{FB}}^{0,\mu}$	0.016181 [147]	4.9×10^{-5}	2.6×10^{-5}
$A_{\text{FB}}^{0,e}$	0.016181 [147]	8.1×10^{-5}	2.6×10^{-5}
Γ_Z [GeV]	2.494682 [101]	0.0005	2×10^{-4}
$R_b \equiv \Gamma_b/\Gamma_{\text{had}}$	0.2158459 [101]	4.3×10^{-5}	7×10^{-5}
$R_\ell \equiv \Gamma_{\text{had}}/\Gamma_\ell$	20.751285 [101]	2.1×10^{-3}	1.5×10^{-3}
$\Gamma_{Z \rightarrow \text{inv}}$ [GeV]	0.167177 [101]	8.4×10^{-5}	–

Table 11.16: Inputs to the CEPC fit. Numbers in bold are expected experimental uncertainties from CEPC measurements. Other entries reflect anticipated uncertainties at the time of CEPC operation. The numbers in the “Value” column for the first five parameters are current measurements; those below the horizontal line give the Standard Model calculated value as a function of the five parameters. Theory uncertainties are future projections assuming complete 3-loop calculations, based on estimates in Refs. [146–149].

The inputs to the fit are listed in Table 11.16. Notice that we have performed the fit directly using forward-backward asymmetry parameters $A_{\text{FB}}^{0,f}$ as inputs, rather than the derived quantities $\sin^2 \theta_{\text{eff}}^f$ that were used in earlier work [150, 151]. The forward-backward asymmetries more directly reflect the experimental measurements; on the other hand, theoretical predictions are often expressed in terms of the effective weak mixing angles [124, 147]. They are related through the asymmetry parameters A_f :

$$A_f = \frac{1 - 4|Q_f| \sin^2 \theta_{\text{eff}}^f}{1 - 4|Q_f| \sin^2 \theta_{\text{eff}}^f + 8|Q_f|^2 \sin^4 \theta_{\text{eff}}^f}, \quad (11.26)$$

$$A_{\text{FB}}^{0,f} = \frac{3}{4} A_e A_f. \quad (11.27)$$

1 There is an extensive literature on the computation of the S and T dependence of ob-
 2 servables (e.g. [139, 140, 152]); a convenient tabulation of the results may be found in
 3 Appendix A of [153]. Assembling these results, we obtain a prediction of the observables
 4 in terms of the five input parameters, S , and T . In the fit we compute a profile likelihood,
 5 floating the five parameters to obtain the maximum likelihood for given S and T .

The fit is performed following [150] (which in turn relied on [154–156]): in constructing a likelihood we treat experimental uncertainties as Gaussian but theory uncertainties as a flat prior, leading to an effective χ^2 function

$$\chi_{\text{mod}}^2 = \sum_j \left[-2 \log \left(\text{erf} \left(\frac{M_j - O_j + \delta_j}{\sqrt{2}\sigma_j} \right) - \text{erf} \left(\frac{M_j - O_j - \delta_j}{\sqrt{2}\sigma_j} \right) \right) - 2 \log \left(\sqrt{2\pi}\sigma_j \right) \right], \quad (11.28)$$

6 with M_j the measured value, O_j the prediction for the observable, σ_j the experimental
 7 uncertainty, and δ_j the theory uncertainty.

8 Our estimates of theory uncertainties assume that full three-loop computations of
 9 the parametric dependence of observables in the Standard Model will be completed. The
 10 remaining uncertainties are estimated based on [146–149]. In the case of the W mass
 11 measurement, an uncertainty of 1 MeV from the computation of the near-threshold WW
 12 cross section is added in quadrature with the estimated four-loop theory uncertainty in the
 13 observable itself.

14 The results of the fit are depicted in Figure 11.18. Solid contours are 68% confidence
 15 level curves, meaning $\Delta\chi_{\text{mod}}^2 = 2.30$; the dashed contour is 98% C.L. ($\Delta\chi_{\text{mod}}^2 = 6.18$).
 16 For clarity we have assumed that the measured central values will precisely agree with
 17 Standard Model predictions. In particular, the contour depicting current constraints is
 18 artificially displaced to be centered at the origin, though it accurately reflects the size
 19 of the uncertainties in current data. From the figure, we see that the results of CEPC will
 20 significantly shrink the error bars on the S and T parameters relative to currently available
 21 data.

By fixing $T = 0$ or $S = 0$, we can also obtain the projected one-parameter 68% C.L. bounds on S and T . As one-parameter fits these correspond to $\Delta\chi_{\text{mod}}^2 = 1.0$. We obtain:

$$|S| < 3.6 \times 10^{-2} \text{ (current)}, \quad 7.9 \times 10^{-3} \text{ (CEPC projection)}, \quad (11.29)$$

$$|T| < 3.1 \times 10^{-2} \text{ (current)}, \quad 8.4 \times 10^{-3} \text{ (CEPC projection)}. \quad (11.30)$$

22 Thus CEPC will achieve about a factor of 4 additional precision on both of the electroweak
 23 oblique parameters.

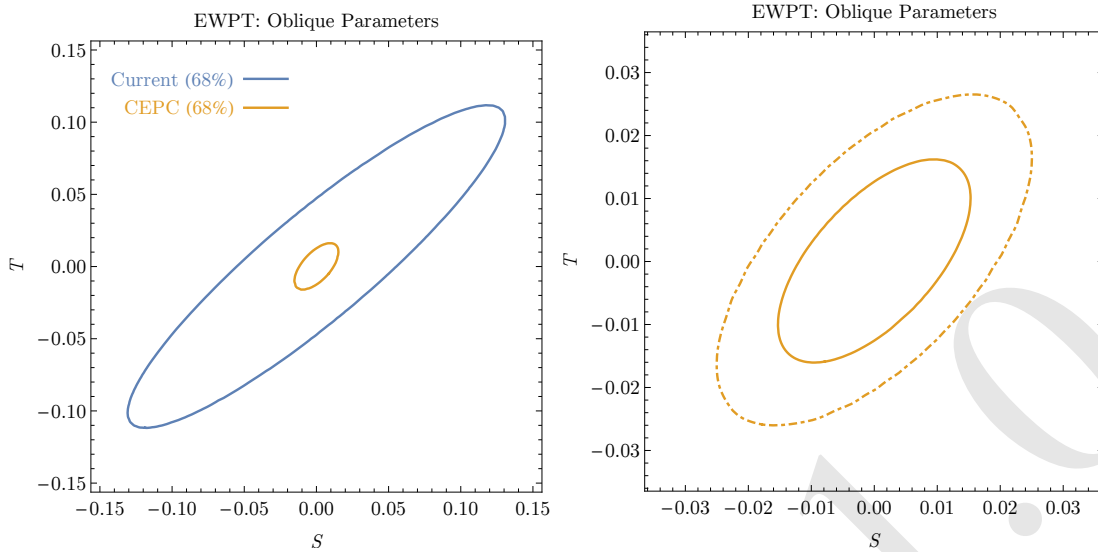

Figure 11.18: CEPC constraints on the oblique parameters S and T . Left panel: comparison of CEPC projection (orange) to current constraints (blue). Contours are 68% confidence level. Right panel: a closer look at the CEPC fit, showing 68% confidence level (solid) and 95% confidence level (dashed).

References

- [1] ATLAS Collaboration Collaboration, *Observation of a new particle in the search for the Standard Model Higgs boson with the ATLAS detector at the LHC*, *Phys. Lett. B* **716** (2012) 1, [arXiv:1207.7214 \[hep-ex\]](#).
- [2] CMS Collaboration Collaboration, *Observation of a new boson at a mass of 125 GeV with the CMS experiment at the LHC*, *Phys. Lett. B* **716** (2012) 30, [arXiv:1207.7235 \[hep-ex\]](#).
- [3] ATLAS Collaboration, G. Aad et al., *Measurements of Higgs boson production and couplings in diboson final states with the ATLAS detector at the LHC*, *Phys. Lett. B* **726** (2013) 88–119, [arXiv:1307.1427 \[hep-ex\]](#). [Erratum: *Phys. Lett. B* **734**, 406(2014)].
- [4] ATLAS Collaboration, G. Aad et al., *Evidence for the spin-0 nature of the Higgs boson using ATLAS data*, *Phys. Lett. B* **726** (2013) 120–144, [arXiv:1307.1432 \[hep-ex\]](#).
- [5] CMS Collaboration Collaboration, S. Chatrchyan et al., *Observation of a new boson with mass near 125 GeV in pp collisions at $\sqrt{s} = 7$ and 8 TeV*, *JHEP* **1306** (2013) 081, [arXiv:1303.4571 \[hep-ex\]](#).
- [6] CMS Collaboration, *Evidence for the direct decay of the 125 GeV Higgs boson to fermions*, *Nature Phys.* **10** (2014), [arXiv:1401.6527 \[hep-ex\]](#).
- [7] CMS Collaboration, V. Khachatryan et al., *Constraints on the spin-parity and anomalous HVV couplings of the Higgs boson in proton collisions at 7 and 8 TeV*, *Phys. Rev. D* **92** (2015) no. 1, 012004, [arXiv:1411.3441 \[hep-ex\]](#).
- [8] ATLAS, CMS Collaboration, G. Aad et al., *Combined Measurement of the Higgs Boson Mass in pp Collisions at $\sqrt{s} = 7$ and 8 TeV with the ATLAS and CMS*

- 1 *Experiments*, *Phys. Rev. Lett.* **114** (2015) 191803, [arXiv:1503.07589](#)
2 [\[hep-ex\]](#).
- 3 [9] ATLAS, CMS Collaboration, G. Aad et al., *Measurements of the Higgs boson*
4 *production and decay rates and constraints on its couplings from a combined*
5 *ATLAS and CMS analysis of the LHC pp collision data at $\sqrt{s} = 7$ and 8 TeV*,
6 *JHEP* **08** (2016) 045, [arXiv:1606.02266](#) [\[hep-ex\]](#).
- 7 [10] F. An, Y. Bai, C. Chen, X. Chen, Z. Chen, J. Guimaraes da Costa, and Z. Cui,
8 *Precision Higgs Boson Physics at the CEPC*, TBD (2018) , [arXiv:nnnn.nnnn](#).
- 9 [11] LHC Higgs Cross Section Working Group, *Handbook of LHC Higgs Cross*
10 *Sections: 1. Inclusive Observables*, [arXiv:1101.0593](#) [\[hep-ph\]](#).
- 11 [12] LHC Higgs Cross Section Working Group, *Handbook of LHC Higgs Cross*
12 *Sections: 2. Differential Distributions*, [arXiv:1201.3084](#) [\[hep-ph\]](#).
- 13 [13] W. Kilian, T. Ohl, and J. Reuter, *WHIZARD: Simulating Multi-Particle Processes*
14 *at LHC and ILC*, *Eur. Phys. J.* **C71** (2011) 1742, [arXiv:0708.4233](#)
15 [\[hep-ph\]](#).
- 16 [14] Y. Haddad, *Feasibility of a minimum bias analysis of $e^+e^- \rightarrow ZH \rightarrow q\bar{q} + X$ at a*
17 *250 GeV ILC*, [arXiv:1404.3164](#) [\[hep-ph\]](#).
- 18 [15] M. Oreglia, *A Study of the Reactions $\psi' \rightarrow \gamma\gamma\psi$* , SLAC-R-0236 (1980) .
19 [http://www.slac.stanford.edu/cgi-wrap/getdoc/
20 slac-r-23\6.pdf](http://www.slac.stanford.edu/cgi-wrap/getdoc/slac-r-23\6.pdf).
- 21 [16] ALEPH, DELPHI, L3, OPAL, LEP Electroweak Collaboration, *Electroweak*
22 *Measurements in Electron-Positron Collisions at W-Boson-Pair Energies at LEP*,
23 *Phys. Rept.* **532** (2013) 119, [arXiv:1302.3415](#) [\[hep-ex\]](#).
- 24 [17] J. Gao, *Probing light-quark Yukawa couplings via hadronic event shapes at lepton*
25 *colliders*, *JHEP* **01** (2018) 038, [arXiv:1608.01746](#) [\[hep-ph\]](#).
- 26 [18] LHC Higgs Cross Section Working Group, *LHC HXSWG interim*
27 *recommendations to explore the coupling structure of a Higgs-like particle*,
28 [arXiv:1209.0040](#) [\[hep-ph\]](#).
- 29 [19] LHC Higgs Cross Section Working Group, *Handbook of LHC Higgs Cross*
30 *Sections: 3. Higgs Properties*, [arXiv:1307.1347](#) [\[hep-ph\]](#).
- 31 [20] S. Dawson, A. Gritsan, H. Logan, J. Qian, C. Tully, et al., *Working Group Report:*
32 *Higgs Boson*, [arXiv:1310.8361](#) [\[hep-ex\]](#).
- 33 [21] CMS Collaboration, *Search for the associated production of the Higgs boson with*
34 *a top-quark pair*, *JHEP* **1409** (2014) 087, [arXiv:1408.1682](#) [\[hep-ex\]](#).
- 35 [22] ATLAS Collaboration, *Search for $H \rightarrow \gamma\gamma$ produced in association with top*
36 *quarks and constraints on the Yukawa coupling between the top quark and the*
37 *Higgs boson using data taken at 7 TeV and 8 TeV with the ATLAS detector*, *Phys.*
38 *Lett.* **B740** (2015) 222, [arXiv:1409.3122](#) [\[hep-ex\]](#).

- 1 [23] A. Banfi, A. Martin, and V. Sanz, *Probing top-partners in Higgs+jets*, **JHEP** **1408**
2 (2014) 053, [arXiv:1308.4771 \[hep-ph\]](#).
- 3 [24] A. Azatov and A. Paul, *Probing Higgs couplings with high p_T Higgs production*,
4 **JHEP** **1401** (2014) 014, [arXiv:1309.5273 \[hep-ph\]](#).
- 5 [25] C. Grojean, E. Salvioni, M. Schlaffer, and A. Weiler, *Very boosted Higgs in gluon*
6 *fusion*, **JHEP** **1405** (2014) 022, [arXiv:1312.3317 \[hep-ph\]](#).
- 7 [26] M. Buschmann, C. Englert, D. Goncalves, T. Plehn, and M. Spannowsky,
8 *Resolving the Higgs-Gluon Coupling with Jets*, **Phys. Rev.** **D90** (2014) 013010,
9 [arXiv:1405.7651 \[hep-ph\]](#).
- 10 [27] J. Ellis, V. Sanz, and T. You, *Complete Higgs Sector Constraints on Dimension-6*
11 *Operators*, **JHEP** **1407** (2014) 036, [arXiv:1404.3667 \[hep-ph\]](#).
- 12 [28] T. Han, Z. Liu, and J. Sayre, *Potential Precision on Higgs Couplings and Total*
13 *Width at the ILC*, **Phys. Rev.** **D89** (2014) 113006, [arXiv:1311.7155](#)
14 [\[hep-ph\]](#).
- 15 [29] M. Klute, R. Lafaye, T. Plehn, M. Rauch, and D. Zerwas, *Measuring Higgs*
16 *Couplings at a Linear Collider*, **Europhys. Lett.** **101** (2013) 51001,
17 [arXiv:1301.1322 \[hep-ph\]](#).
- 18 [30] M. E. Peskin, *Estimation of LHC and ILC Capabilities for Precision Higgs Boson*
19 *Coupling Measurements*, [arXiv:1312.4974 \[hep-ph\]](#).
- 20 [31] K. Fujii et al., *Physics Case for the 250 GeV Stage of the International Linear*
21 *Collider*, [arXiv:1710.07621 \[hep-ex\]](#).
- 22 [32] T. Barklow, K. Fujii, S. Jung, R. Karl, J. List, T. Ogawa, M. E. Peskin, and J. Tian,
23 *Improved Formalism for Precision Higgs Coupling Fits*, [arXiv:1708.08912](#)
24 [\[hep-ph\]](#).
- 25 [33] ATLAS Collaboration, *Projections for measurements of Higgs boson signal*
26 *strengths and coupling parameters with the ATLAS detector at a HL-LHC*,
27 ATL-PHYS-PUB-2014-016 (2014).
28 <http://cds.cern.ch/record/1956710>.
- 29 [34] A. Denner, S. Heinemeyer, I. Puljak, D. Rebuszi, and M. Spira, *Standard Model*
30 *Higgs-Boson Branching Ratios with Uncertainties*, **Eur. Phys. J.** **C71** (2011) 1753,
31 [arXiv:1107.5909 \[hep-ph\]](#).
- 32 [35] L. G. Almeida, S. J. Lee, S. Pokorski, and J. D. Wells, *Study of the standard model*
33 *Higgs boson partial widths and branching fractions*, **Phys. Rev.** **D89** (2014)
34 **033006**, [arXiv:1311.6721 \[hep-ph\]](#).
- 35 [36] G. P. Lepage, P. B. Mackenzie, and M. E. Peskin, *Expected Precision of Higgs*
36 *Boson Partial Widths within the Standard Model*, [arXiv:1404.0319](#)
37 [\[hep-ph\]](#).
- 38 [37] C. Bernaciak, T. Plehn, P. Schichtel, and J. Tattersall, *Spying an invisible Higgs*
39 *boson*, **Phys. Rev.** **D91** (2015) 035024, [arXiv:1411.7699 \[hep-ph\]](#).

- 1 [38] J. Ellis and T. You, *Sensitivities of Prospective Future $e+e-$ Colliders to Decoupled*
2 *New Physics*, **JHEP** **03** (2016) 089, [arXiv:1510.04561 \[hep-ph\]](#).
- 3 [39] J. Ellis, P. Roloff, V. Sanz, and T. You, *Dimension-6 Operator Analysis of the*
4 *CLIC Sensitivity to New Physics*, [arXiv:1701.04804 \[hep-ph\]](#).
- 5 [40] G. Durieux, C. Grojean, J. Gu, and K. Wang, *The leptonic future of the Higgs*,
6 **JHEP** **09** (2017) 014, [arXiv:1704.02333 \[hep-ph\]](#).
- 7 [41] T. Barklow, K. Fujii, S. Jung, M. E. Peskin, and J. Tian, *Model-Independent*
8 *Determination of the Triple Higgs Coupling at e^+e^- Colliders*,
9 [arXiv:1708.09079 \[hep-ph\]](#).
- 10 [42] S. Di Vita, G. Durieux, C. Grojean, J. Gu, Z. Liu, G. Panico, M. Riembau, and
11 T. Vantalon, *A global view on the Higgs self-coupling at lepton colliders*, **JHEP** **02**
12 (2018) 178, [arXiv:1711.03978 \[hep-ph\]](#).
- 13 [43] W. H. Chiu, S. C. Leung, T. Liu, K.-F. Lyu, and L.-T. Wang, *Probing 6D operators*
14 *at future e^-e^+ colliders*, **JHEP** **05** (2018) 081, [arXiv:1711.04046](#)
15 [\[hep-ph\]](#).
- 16 [44] M. Beneke, D. Boito, and Y.-M. Wang, *Anomalous Higgs couplings in angular*
17 *asymmetries of $H \rightarrow Z\ell^+\ell^-$ and $e^+e^- \rightarrow HZ$* , **JHEP** **11** (2014) 028,
18 [arXiv:1406.1361 \[hep-ph\]](#).
- 19 [45] N. Craig, J. Gu, Z. Liu, and K. Wang, *Beyond Higgs Couplings: Probing the*
20 *Higgs with Angular Observables at Future e^+e^- Colliders*, **JHEP** **03** (2016) 050,
21 [arXiv:1512.06877 \[hep-ph\]](#).
- 22 [46] S. M. Barr and A. Zee, *Electric Dipole Moment of the Electron and of the Neutron*,
23 **Phys. Rev. Lett.** **65** (1990) 21–24. [Erratum: **Phys. Rev. Lett.**65,2920(1990)].
- 24 [47] J. Fan and M. Reece, *Probing Charged Matter Through Higgs Diphoton Decay,*
25 *Gamma Ray Lines, and EDMs*, **JHEP** **06** (2013) 004, [arXiv:1301.2597](#)
26 [\[hep-ph\]](#).
- 27 [48] ACME Collaboration, J. Baron et al., *Order of Magnitude Smaller Limit on the*
28 *Electric Dipole Moment of the Electron*, **Science** **343** (2014) 269–272,
29 [arXiv:1310.7534 \[physics.atom-ph\]](#).
- 30 [49] Y. T. Chien, V. Cirigliano, W. Dekens, J. de Vries, and E. Mereghetti, *Direct and*
31 *indirect constraints on CP-violating Higgs-quark and Higgs-gluon interactions*,
32 **JHEP** **02** (2016) 011, [arXiv:1510.00725 \[hep-ph\]](#). [JHEP02,011(2016)].
- 33 [50] R. Harnik, A. Martin, T. Okui, R. Primulando, and F. Yu, *Measuring CP violation*
34 *in $h \rightarrow \tau^+\tau^-$ at colliders*, **Phys. Rev.** **D88** (2013) no. 7, 076009,
35 [arXiv:1308.1094 \[hep-ph\]](#).
- 36 [51] K. Hagiwara, S. Ishihara, R. Szalapski, and D. Zeppenfeld, *Low-energy effects of*
37 *new interactions in the electroweak boson sector*, **Phys. Rev.** **D48** (1993)
38 2182–2203.
- 39 [52] G. Gounaris et al., *Triple gauge boson couplings*, [arXiv:hep-ph/9601233](#)
40 [\[hep-ph\]](#).

- 1 <http://alice.cern.ch/format/showfull?sysnb=0215385>.
2 [,525(1996)].
- 3 [53] L. Bian, J. Shu, and Y. Zhang, *Prospects for Triple Gauge Coupling Measurements*
4 *at Future Lepton Colliders and the 14 TeV LHC*, **JHEP** **09** (2015) 206,
5 [arXiv:1507.02238](https://arxiv.org/abs/1507.02238) [hep-ph].
- 6 [54] A. Falkowski, *Higgs Basis: Proposal for an EFT basis choice for LHC HXSWG*,
7 LHCHXSWG-INT-2015-001 (2015).
8 <https://cds.cern.ch/record/2001958>.
- 9 [55] ATLAS Collaboration, *Projections for measurements of Higgs boson cross*
10 *sections, branching ratios and coupling parameters with the ATLAS detector at a*
11 *HL-LHC*, ATL-PHYS-PUB-2013-014 (2013).
12 <https://cds.cern.ch/record/1611186>.
- 13 [56] ATLAS Collaboration, *HL-LHC projections for signal and background yield*
14 *measurements of the $H \rightarrow \gamma\gamma$ when the Higgs boson is produced in association*
15 *with t quarks, W or Z bosons*, ATL-PHYS-PUB-2014-012 (2014).
16 <https://cds.cern.ch/record/1741011>.
- 17 [57] ATLAS Collaboration, *Update of the prospects for the $H \rightarrow Z\gamma$ search at the*
18 *High-Luminosity LHC*, ATL-PHYS-PUB-2014-006 (2014).
19 <https://cds.cern.ch/record/1703276>.
- 20 [58] ATLAS Collaboration, *Prospects for the study of the Higgs boson in the $VH(bb)$*
21 *channel at HL-LHC*, ATL-PHYS-PUB-2014-011 (2014).
22 <https://cds.cern.ch/record/1740962>.
- 23 [59] ATLAS Collaboration, *Studies of the VBF $H \rightarrow \tau_l\tau_{had}$ analysis at High*
24 *Luminosity LHC conditions*, ATL-PHYS-PUB-2014-018 (2014).
25 <https://cds.cern.ch/record/1956732>.
- 26 [60] A. Falkowski, M. Gonzalez-Alonso, A. Greljo, and D. Marzocca, *Global*
27 *constraints on anomalous triple gauge couplings in effective field theory approach*,
28 **Phys. Rev. Lett.** **116** (2016) no. 1, 011801, [arXiv:1508.00581](https://arxiv.org/abs/1508.00581) [hep-ph].
- 29 [61] A. Butter, O. J. P. Éboli, J. Gonzalez-Fraile, M. C. Gonzalez-Garcia, T. Plehn, and
30 M. Rauch, *The Gauge-Higgs Legacy of the LHC Run I*, **JHEP** **07** (2016) 152,
31 [arXiv:1604.03105](https://arxiv.org/abs/1604.03105) [hep-ph].
- 32 [62] R. Contino, A. Falkowski, F. Goertz, C. Grojean, and F. Riva, *On the Validity of*
33 *the Effective Field Theory Approach to SM Precision Tests*, **JHEP** **07** (2016) 144,
34 [arXiv:1604.06444](https://arxiv.org/abs/1604.06444) [hep-ph].
- 35 [63] A. Falkowski, M. Gonzalez-Alonso, A. Greljo, D. Marzocca, and M. Son,
36 *Anomalous Triple Gauge Couplings in the Effective Field Theory Approach at the*
37 *LHC*, **JHEP** **02** (2017) 115, [arXiv:1609.06312](https://arxiv.org/abs/1609.06312) [hep-ph].
- 38 [64] Z. Zhang, *Time to Go Beyond Triple-Gauge-Boson-Coupling Interpretation of W*
39 *Pair Production*, **Phys. Rev. Lett.** **118** (2017) no. 1, 011803,
40 [arXiv:1610.01618](https://arxiv.org/abs/1610.01618) [hep-ph].

- [65] ATLAS Collaboration, *Search for the Standard Model Higgs and Z Boson decays to $J/\psi\gamma$: HL-LHC projections*, ATL-PHYS-PUB-2015-043 (2015).
<http://cds.cern.ch/record/2054550>.
- [66] G. T. Bodwin, F. Petriello, S. Stoynev, and M. Velasco, *Higgs boson decays to quarkonia and the $H\bar{c}c$ coupling*, *Phys. Rev.* **D88** (2013) no. 5, 053003, [arXiv:1306.5770](https://arxiv.org/abs/1306.5770) [hep-ph].
- [67] G. Perez, Y. Soreq, E. Stamou, and K. Tobioka, *Constraining the charm Yukawa and Higgs-quark coupling universality*, *Phys. Rev.* **D92** (2015) no. 3, 033016, [arXiv:1503.00290](https://arxiv.org/abs/1503.00290) [hep-ph].
- [68] I. Brivio, F. Goertz, and G. Isidori, *Probing the Charm Quark Yukawa Coupling in Higgs+Charm Production*, *Phys. Rev. Lett.* **115** (2015) no. 21, 211801, [arXiv:1507.02916](https://arxiv.org/abs/1507.02916) [hep-ph].
- [69] F. Bishara, U. Haisch, P. F. Monni, and E. Re, *Constraining Light-Quark Yukawa Couplings from Higgs Distributions*, [arXiv:1606.09253](https://arxiv.org/abs/1606.09253) [hep-ph].
- [70] L. M. Carpenter, T. Han, K. Hendricks, Z. Qian, and N. Zhou, *Higgs Boson Decay to Light Jets at the LHC*, *Phys. Rev.* **D95** (2017) no. 5, 053003, [arXiv:1611.05463](https://arxiv.org/abs/1611.05463) [hep-ph].
- [71] ATLAS Collaboration Collaboration, *Study of the double Higgs production channel $H(\rightarrow b\bar{b})H(\rightarrow \gamma\gamma)$ with the ATLAS experiment at the HL-LHC*, ATL-PHYS-PUB-2017-001, CERN, Geneva, Jan, 2017.
<https://cds.cern.ch/record/2243387>.
- [72] R. Contino et al., *Physics at a 100 TeV pp collider: Higgs and EW symmetry breaking studies*, *CERN Yellow Report* (2017) no. 3, 255–440, [arXiv:1606.09408](https://arxiv.org/abs/1606.09408) [hep-ph].
- [73] M. McCullough, *An Indirect Model-Dependent Probe of the Higgs Self-Coupling*, *Phys. Rev.* **D90** (2014) 015001, [arXiv:1312.3322](https://arxiv.org/abs/1312.3322) [hep-ph].
- [74] S. Di Vita, C. Grojean, G. Panico, M. Riembau, and T. Vantalón, *A global view on the Higgs self-coupling*, *JHEP* **09** (2017) 069, [arXiv:1704.01953](https://arxiv.org/abs/1704.01953) [hep-ph].
- [75] A. Azatov, R. Contino, G. Panico, and M. Son, *Effective field theory analysis of double Higgs boson production via gluon fusion*, *Phys. Rev.* **D92** (2015) no. 3, 035001, [arXiv:1502.00539](https://arxiv.org/abs/1502.00539) [hep-ph].
- [76] J. A. Aguilar-Saavedra, *A Minimal set of top anomalous couplings*, *Nucl. Phys.* **B812** (2009) 181–204, [arXiv:0811.3842](https://arxiv.org/abs/0811.3842) [hep-ph].
- [77] J. A. Aguilar-Saavedra, *A Minimal set of top-Higgs anomalous couplings*, *Nucl. Phys.* **B821** (2009) 215–227, [arXiv:0904.2387](https://arxiv.org/abs/0904.2387) [hep-ph].
- [78] Z. Liu, I. Low, and L.-T. Wang, *Higgs-Top Interactions at Future Circular e^+e^- Colliders*, [arXiv:2018.nnnn](https://arxiv.org/abs/2018.nnnn).
- [79] G. Li, H.-R. Wang, and S.-h. Zhu, *Probing CP-violating $h\bar{t}t$ coupling in $e^+e^- \rightarrow h\gamma$* , [arXiv:1506.06453](https://arxiv.org/abs/1506.06453) [hep-ph].

- 1 [80] E. Vryonidou and C. Zhang, *Dimension-six electroweak top-loop effects in Higgs*
2 *production and decay*, [arXiv:1804.09766 \[hep-ph\]](#).
- 3 [81] G. Durieux, *Precision constraints on the top-quark effective field theory at future*
4 *lepton colliders*, PoS **DIS2017** (2018) 088, [arXiv:1708.09849 \[hep-ph\]](#).
- 5 [82] Y. Gao, A. V. Gritsan, Z. Guo, K. Melnikov, M. Schulze, and N. V. Tran, *Spin*
6 *determination of single-produced resonances at hadron colliders*, [Phys. Rev. **D81**](#)
7 [\(2010\) 075022](#), [arXiv:1001.3396 \[hep-ph\]](#).
- 8 [83] S. Bolognesi, Y. Gao, A. V. Gritsan, K. Melnikov, M. Schulze, N. V. Tran, and
9 A. Whitbeck, *On the spin and parity of a single-produced resonance at the LHC*,
10 [Phys. Rev. **D86** \(2012\) 095031](#), [arXiv:1208.4018 \[hep-ph\]](#).
- 11 [84] I. Anderson et al., *Constraining anomalous HVV interactions at proton and lepton*
12 *colliders*, [Phys. Rev. **D89** \(2014\) no. 3, 035007](#), [arXiv:1309.4819](#)
13 [\[hep-ph\]](#).
- 14 [85] J. Alwall, P. Demin, S. de Visscher, R. Frederix, M. Herquet, F. Maltoni, T. Plehn,
15 D. L. Rainwater, and T. Stelzer, *MadGraph/MadEvent v4: The New Web*
16 *Generation*, [JHEP **09** \(2007\) 028](#), [arXiv:0706.2334 \[hep-ph\]](#).
- 17 [86] J. Erler, S. Heinemeyer, W. Hollik, G. Weiglein, and P. Zerwas, *Physics impact of*
18 *GigaZ*, [Phys.Lett. **B486** \(2000\) 125–133](#), [arXiv:hep-ph/0005024](#)
19 [\[hep-ph\]](#).
- 20 [87] L. Arnaudon, B. Dehning, P. Grosse-Wiesmann, R. Jacobsen, M. Jonker, J. P.
21 Koutchouk, J. Miles, R. Olsen, M. Placidi, R. Schmidt, J. Wenninger, R. Assmann,
22 and A. Blondel, *Accurate determination of the LEP beam energy by resonant*
23 *depolarization*, [Zeitschrift für Physik C Particles and Fields **66** \(Mar, 1995\) 45–62](#).
24 <https://doi.org/10.1007/BF01496579>.
- 25 [88] S. Jadach, M. Skrzypek, and B. F. L. Ward, *Is there a better way of exponentiating*
26 *QED corrections?*, [Phys. Lett. **B257** \(1991\) 173–178](#).
- 27 [89] G. Montagna, O. Nicrosini, and F. Piccinini, *The QED radiator at order alpha**3*,
28 [Phys. Lett. **B406** \(1997\) 243–248](#), [arXiv:hep-ph/9611463 \[hep-ph\]](#).
- 29 [90] G. Montagna, F. Piccinini, O. Nicrosini, G. Passarino, and R. Pittau, *On a*
30 *semianalytical and realistic approach to e^+e^- annihilation into fermion pairs and*
31 *to Bhabha scattering within the minimal Standard Model at LEP energies*, [Nucl.](#)
32 [Phys. **B401** \(1993\) 3–66](#).
- 33 [91] G. Montagna, F. Piccinini, O. Nicrosini, G. Passarino, and R. Pittau, *TOPAZO: A*
34 *Program for computing observables and for fitting cross-sections and forward -*
35 *backward asymmetries around the Z0 peak*, [Comput. Phys. Commun. **76** \(1993\)](#)
36 [328–360](#).
- 37 [92] G. Montagna, O. Nicrosini, G. Passarino, and F. Piccinini, *TOPAZO 2.0: A*
38 *Program for computing deconvoluted and realistic observables around the Z0*
39 *peak*, [Comput. Phys. Commun. **93** \(1996\) 120–126](#), [arXiv:hep-ph/9506329](#)
40 [\[hep-ph\]](#).

- [93] G. Montagna, O. Nicrosini, F. Piccinini, and G. Passarino, *TOPAZO 4.0: A New version of a computer program for evaluation of deconvoluted and realistic observables at LEP-1 and LEP-2*, *Comput. Phys. Commun.* **117** (1999) 278–289, [arXiv:hep-ph/9804211 \[hep-ph\]](#).
- [94] D. Yu. Bardin, M. S. Bilenky, T. Riemann, M. Sachwitz, and H. Vogt, *Dizet: A Program Package for the Calculation of Electroweak One Loop Corrections for the Process $e^+ e^- \rightarrow f^+ f^-$ Around the Z0 Peak*, *Comput. Phys. Commun.* **59** (1990) 303–312.
- [95] D. Yu. Bardin et al., *ZFITTER: An Analytical program for fermion pair production in $e^+ e^-$ annihilation*, [arXiv:hep-ph/9412201 \[hep-ph\]](#).
- [96] D. Yu. Bardin, P. Christova, M. Jack, L. Kalinovskaya, A. Olchevski, S. Riemann, and T. Riemann, *ZFITTER v.6.21: A Semianalytical program for fermion pair production in $e^+ e^-$ annihilation*, *Comput. Phys. Commun.* **133** (2001) 229–395, [arXiv:hep-ph/9908433 \[hep-ph\]](#).
- [97] D. Bardin and G. Passarino, *Results of the working group on precision calculations for the Z resonance*, in *Proceedings, 8th J.A. Swieca Summer School on Particles and Fields: Rio de Janeiro, Brazil, February 5-18, 1995*, pp. 17–41. 1995.
- [98] D. Yu. Bardin, M. Grunewald, and G. Passarino, *Precision calculation project report*, [arXiv:hep-ph/9902452 \[hep-ph\]](#).
- [99] D. Yu. Bardin and G. Passarino, *The standard model in the making: Precision study of the electroweak interactions*. 1999.
- [100] A. Borrelli, M. Consoli, L. Maiani, and R. Sisto, *Model Independent Analysis of the Z Line Shape in $e^+ e^-$ Annihilation*, *Nucl. Phys.* **B333** (1990) 357–379.
- [101] I. Dubovyk, A. Freitas, J. Gluza, T. Riemann, and J. Usovitsch, *Complete electroweak two-loop corrections to Z boson production and decay*, [arXiv:1804.10236 \[hep-ph\]](#).
- [102] A. Leike, T. Riemann, and J. Rose, *S matrix approach to the Z line shape*, *Phys. Lett.* **B273** (1991) 513–518, [arXiv:hep-ph/9508390 \[hep-ph\]](#).
- [103] S. Kirsch and T. Riemann, *SMATASY: A program for the model independent description of the Z resonance*, *Comput. Phys. Commun.* **88** (1995) 89–108, [arXiv:hep-ph/9408365 \[hep-ph\]](#).
- [104] T. Riemann, *S-matrix Approach to the Z Resonance*, *Acta Phys. Polon.* **B46** (2015) no. 11, 2235, [arXiv:1610.04501 \[hep-ph\]](#).
- [105] ALEPH Collaboration, D. Buskulic et al., *Four jet final state production in $e^+ e^-$ collisions at center-of-mass energies of 130-GeV and 136-GeV*, *Z. Phys.* **C71** (1996) 179–198.
- [106] DELPHI Collaboration, P. Abreu et al., *Measurement and interpretation of fermion pair production at LEP energies from 130-GeV to 172-GeV*, *Eur. Phys. J.* **C11** (1999) 383–407.

- [107] L3 Collaboration, M. Acciarri et al., *Determination of γ/Z interference in e^+e^- annihilation at LEP*, *Phys. Lett.* **B489** (2000) 93–101, [arXiv:hep-ex/0007006](#) [hep-ex].
- [108] OPAL Collaboration, K. Ackerstaff et al., *Tests of the standard model and constraints on new physics from measurements of fermion pair production at 130-GeV to 172-GeV at LEP*, *Eur. Phys. J.* **C2** (1998) 441–472, [arXiv:hep-ex/9708024](#) [hep-ex].
- [109] ALEPH Collaboration, DELPHI Collaboration, L3 Collaboration, OPAL Collaboration, LEP Electroweak Working Group Collaboration, J. Alcaraz et al., *A Combination of preliminary electroweak measurements and constraints on the standard model*, [arXiv:hep-ex/0612034](#) [hep-ex].
- [110] L3 Collaboration, M. Acciarri et al., *Measurement of $R(b)$ and $Br(b \rightarrow \text{lepton neutrino } X)$ at LEP using double tag methods*, *Eur. Phys. J.* **C13** (2000) 47–61, [arXiv:hep-ex/9909045](#) [hep-ex].
- [111] OPAL Collaboration, G. Abbiendi et al., *A Measurement of $R(b)$ using a double tagging method*, *Eur. Phys. J.* **C8** (1999) 217–239, [arXiv:hep-ex/9810002](#) [hep-ex].
- [112] DELPHI Collaboration, P. Abreu et al., *A Precise measurement of the partial decay width ratio $R_b^0 = \Gamma(b\bar{b})/\Gamma(\text{had})$* , *Eur.Phys.J.* **C10** (1999) 415–442.
- [113] ALEPH Collaboration, R. Barate et al., *A Measurement of $R(b)$ using mutually exclusive tags*, *Phys. Lett.* **B401** (1997) 163–175.
- [114] SLD Collaboration, K. Abe et al., *Measurement of the branching ratio of the Z^0 into heavy quarks*, *Phys.Rev.* **D71** (2005) 112004, [arXiv:hep-ex/0503005](#) [hep-ex].
- [115] OPAL Collaboration, G. Abbiendi et al., *Precise determination of the Z resonance parameters at LEP: 'Zedometry'*, *Eur. Phys. J.* **C19** (2001) 587–651, [arXiv:hep-ex/0012018](#) [hep-ex].
- [116] DELPHI Collaboration, P. Abreu et al., *Cross-sections and leptonic forward backward asymmetries from the Z^0 running of LEP*, *Eur. Phys. J.* **C16** (2000) 371–405.
- [117] L3 Collaboration, M. Acciarri et al., *Measurements of cross-sections and forward backward asymmetries at the Z resonance and determination of electroweak parameters*, *Eur. Phys. J.* **C16** (2000) 1–40, [arXiv:hep-ex/0002046](#) [hep-ex].
- [118] ALEPH Collaboration, R. Barate et al., *Measurement of the Z resonance parameters at LEP*, *Eur. Phys. J.* **C14** (2000) 1–50.
- [119] SLD Collaboration, K. Abe et al., *Direct measurements of $A(b)$ and $A(c)$ using vertex/kaon charge tags at SLD*, *Phys. Rev. Lett.* **94** (2005) 091801, [arXiv:hep-ex/0410042](#) [hep-ex].

- [120] ALEPH Collaboration Collaboration, A. Heister et al., *Measurement of $A^b(FB)$ using inclusive b hadron decays*, *Eur.Phys.J.* **C22** (2001) 201–215, [arXiv:hep-ex/0107033 \[hep-ex\]](#).
- [121] OPAL Collaboration Collaboration, G. Abbiendi et al., *Measurement of the b quark forward backward asymmetry around the Z^0 peak using an inclusive tag*, *Phys.Lett.* **B546** (2002) 29–47, [arXiv:hep-ex/0209076 \[hep-ex\]](#).
- [122] DELPHI Collaboration Collaboration, J. Abdallah et al., *Determination of $A^b(FB)$ at the Z pole using inclusive charge reconstruction and lifetime tagging*, *Eur.Phys.J.* **C40** (2005) 1–25, [arXiv:hep-ex/0412004 \[hep-ex\]](#).
- [123] L3 Collaboration Collaboration, M. Acciarri et al., *Measurement of the $e^+e^- \rightarrow Z \rightarrow b\bar{b}$ forward–backward asymmetry and the B^0 anti- B^0 mixing parameter using prompt leptons*, *Phys.Lett.* **B448** (1999) 152–162.
- [124] I. Dubovyk, A. Freitas, J. Gluza, T. Riemann, and J. Usovitsch, *The two-loop electroweak bosonic corrections to $\sin^2 \theta_{\text{eff}}^b$* , *Phys. Lett.* **B762** (2016) 184–189, [arXiv:1607.08375 \[hep-ph\]](#).
- [125] ALEPH Collaboration, DELPHI Collaboration, L3 Collaboration, OPAL Collaboration, SLD Collaboration, LEP Electroweak Working Group, SLD Electroweak Group, SLD Heavy Flavour Group Collaboration, S. Schael et al., *Precision electroweak measurements on the Z resonance*, *Phys.Rept.* **427** (2006) 257–454, [arXiv:hep-ex/0509008 \[hep-ex\]](#).
- [126] B. F. L. Ward, S. Jadach, M. Melles, and S. A. Yost, *New results on the theoretical precision of the LEP / SLC luminosity*, *Phys. Lett.* **B450** (1999) 262–266, [arXiv:hep-ph/9811245 \[hep-ph\]](#).
- [127] G. Montagna, M. Moretti, O. Nicrosini, A. Pallavicini, and F. Piccinini, *Light pair corrections to small angle Bhabha scattering in a realistic set up at LEP*, *Phys. Lett.* **B459** (1999) 649–652, [arXiv:hep-ph/9905235 \[hep-ph\]](#).
- [128] G. Montagna, M. Moretti, O. Nicrosini, A. Pallavicini, and F. Piccinini, *Light pair correction to Bhabha scattering at small angle*, *Nucl. Phys.* **B547** (1999) 39–59, [arXiv:hep-ph/9811436 \[hep-ph\]](#).
- [129] F. Jegerlehner, *Variations on Photon Vacuum Polarization*, [arXiv:1711.06089 \[hep-ph\]](#).
- [130] C. M. Carloni Calame, *Selected topics in electroweak physics at future e^+e^- colliders*, . CEPC Workshop, Wuhan, China.
- [131] S. Jadach, *QED calculations for Bhabha luminometer*, . FCAL Workshop at INP-PAN, Cracow, Poland.
- [132] G. Montagna, M. Moretti, O. Nicrosini, and F. Piccinini, *Single photon and multiphoton final states with missing energy at e^+e^- colliders*, *Nucl. Phys.* **B541** (1999) 31–49, [arXiv:hep-ph/9807465 \[hep-ph\]](#).
- [133] Y. Kurihara, J. Fujimoto, T. Ishikawa, Y. Shimizu, and T. Munehisa, (*g ν neutrino neutrino gamma*) *Event generator for the single photon and double photon*

- 1 *emission associated with neutrino pair production*, *Comput. Phys. Commun.* **136**
2 (2001) 250–268, [arXiv:hep-ph/9908422](https://arxiv.org/abs/hep-ph/9908422) [hep-ph].
- 3 [134] A. Jacholkowska, J. Kalinowski, and Z. Was, *Higher order QED corrections to*
4 $e^+e^- \rightarrow \nu\bar{\nu}\gamma$ *at LEP-2*, *Eur. Phys. J.* **C6** (1999) 485–491,
5 [arXiv:hep-ph/9803375](https://arxiv.org/abs/hep-ph/9803375) [hep-ph].
- 6 [135] S. Jadach, B. F. L. Ward, and Z. Was, *The Monte Carlo program KORALZ, for the*
7 *lepton or quark pair production at LEP / SLC energies: From version 4.0 to*
8 *version 4.04*, *Comput. Phys. Commun.* **124** (2000) 233–237,
9 [arXiv:hep-ph/9905205](https://arxiv.org/abs/hep-ph/9905205) [hep-ph].
- 10 [136] S. Jadach, B. F. L. Ward, and Z. Was, *The Monte Carlo program KORALZ, version*
11 *4.0, for the lepton or quark pair production at LEP / SLC energies*, *Comput. Phys.*
12 *Commun.* **79** (1994) 503–522.
- 13 [137] S. Jadach, B. F. L. Ward, and Z. Was, *The Monte Carlo program KORALZ, version*
14 *3.8, for the lepton or quark pair production at LEP / SLC energies*, *Comput. Phys.*
15 *Commun.* **66** (1991) 276–292.
- 16 [138] D. Bardin, S. Jadach, T. Riemann, and Z. Was, *Predictions for anti- ν ν gamma*
17 *production at LEP*, *Eur. Phys. J.* **C24** (2002) 373–383,
18 [arXiv:hep-ph/0110371](https://arxiv.org/abs/hep-ph/0110371) [hep-ph].
- 19 [139] M. E. Peskin and T. Takeuchi, *A New constraint on a strongly interacting Higgs*
20 *sector*, *Phys.Rev.Lett.* **65** (1990) 964–967.
- 21 [140] M. E. Peskin and T. Takeuchi, *Estimation of oblique electroweak corrections*,
22 *Phys.Rev.* **D46** (1992) 381–409.
- 23 [141] J. Wudka, *Effective Lagrangians (for electroweak physics)*, in *4th Mexican*
24 *Workshop on Particles and Fields Yucatan, Mexico, October 25-29, 1993*,
25 pp. 61–106. 1994. [arXiv:hep-ph/9405206](https://arxiv.org/abs/hep-ph/9405206) [hep-ph].
- 26 [142] J. Erler and F. Ayres, *Electroweak Model and Constraints on New Physics*, Particle
27 Data Group review . [http://pdg.lbl.gov/2014/reviews/](http://pdg.lbl.gov/2014/reviews/rpp2014-rev-standard-model.pdf)
28 [rpp2014-rev-standard-model.pdf](http://pdg.lbl.gov/2014/reviews/rpp2014-rev-standard-model.pdf).
- 29 [143] M. Baak, J. Cuth, J. Haller, A. Hoecker, R. Kogler, et al., *The global electroweak*
30 *fit at NNLO and prospects for the LHC and ILC*, [arXiv:1407.3792](https://arxiv.org/abs/1407.3792)
31 [hep-ph].
- 32 [144] CMS Collaboration, *Projected improvement of the accuracy of top-quark mass*
33 *measurements at the upgraded LHC*, CMS-PAS-FTR-13-017, CERN, Geneva,
34 2013. <https://cds.cern.ch/record/1605627>.
- 35 [145] J. Erler, *Status of Precision Extractions of α_s and Heavy Quark Masses*, *AIP Conf.*
36 *Proc.* **1701** (2016) 020009, [arXiv:1412.4435](https://arxiv.org/abs/1412.4435) [hep-ph].
- 37 [146] M. Awramik, M. Czakon, A. Freitas, and G. Weiglein, *Precise prediction for the*
38 *W boson mass in the standard model*, *Phys.Rev.* **D69** (2004) 053006,
39 [arXiv:hep-ph/0311148](https://arxiv.org/abs/hep-ph/0311148) [hep-ph].

- 1 [147] M. Awramik, M. Czakon, and A. Freitas, *Electroweak two-loop corrections to the*
2 *effective weak mixing angle*, **JHEP** **0611** (2006) 048,
3 [arXiv:hep-ph/0608099](https://arxiv.org/abs/hep-ph/0608099) [hep-ph].
- 4 [148] A. Freitas, K. Hagiwara, S. Heinemeyer, P. Langacker, K. Moenig, M. Tanabashi,
5 and G. W. Wilson, *Exploring Quantum Physics at the ILC*, in *Proceedings, 2013*
6 *Community Summer Study on the Future of U.S. Particle Physics: Snowmass on*
7 *the Mississippi (CSS2013): Minneapolis, MN, USA, July 29-August 6, 2013*. 2013.
8 [arXiv:1307.3962](https://arxiv.org/abs/1307.3962) [hep-ph].
9 [https://inspirehep.net/record/1242667/files/arXiv:](https://inspirehep.net/record/1242667/files/arXiv:1307.3962.pdf)
10 [1307.3962.pdf](https://inspirehep.net/record/1242667/files/arXiv:1307.3962.pdf).
- 11 [149] A. Freitas, *Higher-order electroweak corrections to the partial widths and*
12 *branching ratios of the Z boson*, **JHEP** **04** (2014) 070, [arXiv:1401.2447](https://arxiv.org/abs/1401.2447)
13 [hep-ph].
- 14 [150] J. Fan, M. Reece, and L.-T. Wang, *Possible Futures of Electroweak Precision: ILC,*
15 *FCC-ee, and CEPC*, **JHEP** **09** (2015) 196, [arXiv:1411.1054](https://arxiv.org/abs/1411.1054) [hep-ph].
- 16 [151] CEPC-SPPC Study Group, *CEPC-SPPC Preliminary Conceptual Design Report.*
17 *1. Physics and Detector (2015)* .
18 <http://cepc.ihep.ac.cn/preCDR/volume.html>.
- 19 [152] C. Burgess, S. Godfrey, H. Konig, D. London, and I. Maksymyk, *Model*
20 *independent global constraints on new physics*, **Phys.Rev.** **D49** (1994) 6115–6147,
21 [arXiv:hep-ph/9312291](https://arxiv.org/abs/hep-ph/9312291) [hep-ph].
- 22 [153] M. Ciuchini, E. Franco, S. Mishima, and L. Silvestrini, *Electroweak Precision*
23 *Observables, New Physics and the Nature of a 126 GeV Higgs Boson*, **JHEP** **08**
24 (2013) 106, [arXiv:1306.4644](https://arxiv.org/abs/1306.4644) [hep-ph].
- 25 [154] A. Hocker, H. Lacker, S. Laplace, and F. Le Diberder, *A New approach to a global*
26 *fit of the CKM matrix*, **Eur.Phys.J.** **C21** (2001) 225–259,
27 [arXiv:hep-ph/0104062](https://arxiv.org/abs/hep-ph/0104062) [hep-ph].
- 28 [155] H. Flacher, M. Goebel, J. Haller, A. Hocker, K. Monig, et al., *Revisiting the*
29 *Global Electroweak Fit of the Standard Model and Beyond with Gfitter*,
30 **Eur.Phys.J.** **C60** (2009) 543–583, [arXiv:0811.0009](https://arxiv.org/abs/0811.0009) [hep-ph].
- 31 [156] R. Lafaye, T. Plehn, M. Rauch, D. Zerwas, and M. Duhrssen, *Measuring the Higgs*
32 *Sector*, **JHEP** **0908** (2009) 009, [arXiv:0904.3866](https://arxiv.org/abs/0904.3866) [hep-ph].

Draft-V1.0

CHAPTER 12

FUTURE PLANS AND R&D PROSPECTS

1 Since the release of the pre-CDR, the main effort of the CDR has been focusing on explor-
2 ing different concepts of the detector design. In addition to a baseline detector optimized
3 from ILD with 3T magnetic field, two alternative detectors are also proposed. One with
4 a full-silicon tracker and another one with a drift chamber under 2T magnetic field. The
5 baseline concept detector is used to evaluate the physics potential of the 240 GeV CEPC
6 accelerator.

7 For the next TDR phase more in-depth studies will be carried out. (ADD SUM-
8 MARY OF THE REST SECTIONS...)

9 **12.1 Tracking**

10 **12.1.1 Vertex**

11 As the inner most layers, the vertex detector has to fulfill the most demanding require-
12 ments imposed by the physics program. To meet these requirements of single-point reso-
13 lution, low material budget, fast readout, low power consumption and radiation tolerance,
14 coherent R&D activities have to be pursued:

- 15 ▪ Enhancement of density, radiation hardness and ultra-light module assembling.
- 16 ▪ Explore smaller production line for TowerJazz and LAPIS in conjunction with the
17 NpD (Nano-particle deposition) technique.
- 18 ▪ Improve the charge collection efficiency of the TowerJazz process by N-type implant
- 19 ▪ Improve the radiation hardness and low power design for SOI process.

- 1 ▪ Sensor thinning for CMOS and SOI.
- 2 ▪ Detailed designs for mechanical supports to enable cooling, cabling and power con-
- 3 servation.

4 **12.1.2 Silicon tracker**

5 Placed outside the vertex detector and after the TPC, the silicon tracker forms the complete
6 tracking system of CEPC. The silicon tracker is designed to have low material budget
7 and high tracking efficiency. With preliminary studies, several critical R&D items are
8 identified for the next TDR phase:

- 9 ▪ Alternative pixelated strip sensors with CMOS technologies;
- 10 ▪ p^+ -on-n silicon microstrip sensors with slim-edge structure;
- 11 ▪ Front-end electronics with low power consumption and low noise, fabricated with
12 CMOS technologies of small feature size;
- 13 ▪ Efficient powering with low material budget and CO_2 cooling techniques;
- 14 ▪ Lightweight but robust support structure and related mechanics;
- 15 ▪ Detector layout optimization, in particular in the forward region.

16 **12.1.3 TPC**

17 Time Projection Chambers is considered as the baseline central tracker for the CEPC
18 tracking system. Modularized design with gas amplification and readout pad optimization
19 have been investigated. The low power consumption electronics and ion backflow (IBF)
20 are also considered. The future R&D consists:

- 21 ▪ Hybrid structure TPC detector module,
- 22 ▪ Laser calibration and alignment system.

23 **12.1.4 Full-silicon tracker**

24 To demonstrate a viable option for CEPC under the same detector boundary conditions of
25 the baseline design, the TPC is replaced with a full-silicon tracker (CEPC-FST) layout.
26 A second approach is used to fulfill the CEPC tracking volume with the ILC-SID tracker
27 to achieve better momentum resolution. To explore the full potential of the all silicon
28 tracker, possible improvements are:

- 29 ▪ Optimize the layout for better performance and lower cost based on satisfy mechanics.
- 30 ▪ Study physical performance and find out which physics processes are suitable for
31 evaluation.

32 **12.1.5 Drift Chamber tracker**

33 The drift chamber tracker is another option to provide good tracking, high precision mo-
34 mentum measurement and excellent particle identification by cluster counting.

- 1 ▪ Final layout optimization of the full tracking system, which, besides the drift chamber,
2 includes the vertex detector and the silicon micro-strip detector layers (the silicon
3 wrapper, as indicated in Figure 3.11).
- 4 ▪ Studies for a non-flammable gas mixture alternative to He/Isobutane 90/10.
- 5 ▪ Particle identification performance with cluster counting, to be assessed in beam tests
6 of realistic drift chamber prototypes.
- 7 ▪ Full length (> 4 m) prototypes to establish limits of the wires electrostatic stability.

8 12.2 Calorimetry

9 Two technology options respectively based on the Particle Flow Algorithm (PFA) con-
10 cept and the dual-readout concept are both being explored for the design of the CEPC
11 calorimetry system. The PFA approach aims to develop both a high-granularity electro-
12 magnetic calorimeter (ECAL) and a high-granularity hadronic calorimeter (HCAL) that
13 are capable of measuring individual particles in a jet, while the dual-readout approach
14 aims for a combined and homogeneous calorimeter with excellent performance for both
15 electromagnetic and hadronic particle showers.

16 12.2.1 PFA-ECAL

17 The CEPC ECAL is required to have a good intrinsic energy resolution for precise energy
18 measurement of electrons and photons, as well as excellent shower imaging capability
19 that would allow to identify photons from close-by showers, reconstruct detailed prop-
20 erties of a shower and distinguish electromagnetic showers from hadronic ones very ef-
21 fectively. Extensive and focused R&D will be conducted on developing a tungsten-based
22 high-granularity sampling calorimeter with either silicon or scintillator as active medium
23 to address the above requirements for the CEPC ECAL. Future study work towards com-
24 pletion of a TDR will involve detector design optimisation and critical common R&D in
25 view of the CEPC experimental conditions, particularly the continuous operation mode
26 imposed by the CEPC accelerator, and a great deal of prototyping for the two ECAL
27 technology options.

- 28 ▪ Design optimisation and common R&D
 - 29 – Optimisation of primary detector parameters with full detector simulation.
 - 30 – Thermal studies of detector and electronics components using both simulation and
31 experiment.
 - 32 – Cooling design based on the above studies and prototyping.
- 33 ▪ Silicon-Tungsten ECAL
 - 34 – Full characterisation of a physics Silicon-Tungsten ECAL prototype using its ex-
35 isting test beam data.
 - 36 – Development of a technological prototype to address power, cooling and front-end
37 electronics issues.
 - 38 – Design of detector modules. Development of technology for fabricating large-size
39 detector modules.

1 ▪ Scintillator-Tungsten ECAL

- 2 – Development of a SiPM-scintillator coupling scheme that allows very large dy-
- 3 dynamic range.
- 4 – Development of technology of fabricating high-quality scintillator strips with re-
- 5 quired fine structures.
- 6 – Design, construction and characterisation of a small-size physics prototype.
- 7 – Development of a technological prototype to address power, cooling and frond-end
- 8 electronics issues.
- 9 – Design of detector modules. Development of techlogy for fabricating large-size
- 10 detector modules.

11 **12.2.2 PFA-HCAL**

12 The future plans of HCAL include R&D on new gaseous detector technology for PFA-

13 HCAL, design, construction and characterisation of various prototypes.

- 14 ▪ DHCAL based on RPC, Test beams and performance study
- 15 ▪ MRPC with better time resolution (about 50ps)
- 16 ▪ THGEM with very compact structure and stable operation
- 17 ▪ AHCAL based on scintillator + SiPM, prototype design and construction, perfor-
- 18 mance study

19 **12.2.3 Dual-readout calorimeter**

20 Concerning the dual-readout calorimeter, a 3-year R&D programme is being pursued in

21 order to address and clarify the following issues:

- 22 ▪ absorber material choice, current candidates are lead, brass and iron;
- 23 ▪ machining and assembly procedure for modules of $\sim 10 \times 10 \text{ cm}^2$ cross section;
- 24 ▪ development of a modular, projective solution for a 4π calorimeter concerning both
- 25 the construction of single modules and the design and construction of a full detector;
- 26 ▪ identification of adequate solid-state photo-sensors in order to independently opti-
- 27 mise both Čerenkov and scintillation light detection (with respect to PDE, linearity,
- 28 dynamic range and cross-talk performance);
- 29 ▪ readout granularity (i.e. identify the optimal fibre grouping into a single readout chan-
- 30 nel);
- 31 ▪ identification of a tailored front-end electronics, likely composed by an ASIC and
- 32 an FPGA chip, in order to extract in real time both charge and time information (in
- 33 principle, a time resolution of 100 ps should allow to identify the shower starting point
- 34 inside the calorimeter with a precision of about 6 cm);
- 35 ▪ particle ID performance with Particle Flow Algorithms, with and without a longitudi-
- 36 nal segmentation;

- 1 ▪ development and validation of full and fast simulations of both testbeam modules and
2 an integrated 4π detector;
- 3 ▪ assessment of the performance for the most relevant physics channels (such as W, Z,
4 H decays).

5 **12.3 Magnet**

6 A detector superconducting solenoid with 3.0T central field is chosen for this CDR for
7 feasibility reasons. It makes full cancellation to avoid disturbance to the beam with tech-
8 nologies in coming years. For the TDR phase, the following R&D work will be conducted:

- 9 ▪ Further development of longer and higher I_c Aluminum based NbTi superconductor,
10 the length longer than 100m, and I_c will larger than 15kA at 4 T background mag-
11 netic field. (For the reference, we have developed 10m long Aluminum based NbTi
12 superconductor, the I_c 5kA at 4 T background magnetic field up to now.)
- 13 ▪ Build a prototype to study large coil winding process and cooling method by liquid
14 helium thermal siphon.
- 15 ▪ Study of candidate option by using large HTS magnet and the related cooling method
16 at 20K.

17 **12.4 Muon system**

18 Located within the solenoid flux return yoke, the muon system is required to identify
19 muons with very high efficiency. Both Resistive Plate Chamber (RPC) and Micro Pattern
20 Gas detector (MPGD) are considered in CDR. Future R&D requires detailed studies of
21 different technologies and further optimization of baseline design parameters. Several
22 critical R&D items have been identified, including:

- 23 ▪ Long-lived particles optimization: Explore new physics scenario of long-lived parti-
24 cles and exotic decays. Optimize detector parameters and technologies.
- 25 ▪ Layout and geometry optimization: Detailed studies on the structure of the segments
26 and modules need to be carried out to minimise the dead area and to optimise the
27 interface for routing, support and assembly.
- 28 ▪ Detector optimization: Study aging effects, improve long-term reliability and stabil-
29 ity, readout technologies.
- 30 ▪ Detector industrialization: Improve massive and large area production procedures for
31 all technologies.

32 **12.5 DAQ**

33 New technologies will emerge before the CEPC DAQ system has to be built. Attention
34 will be made to follow and explore the ongoing improvement of the data communication
35 and processing technologies. In particular the following areas will be addressed:

- 1 ▪ The high speed and low latency communication technology should be the key point
2 for data readout.
- 3 ▪ A high efficient data flow distribution schema is another key point for data dispatching
4 on a huge computing farm. There the data are concentrated, re-formatted, possibly
5 zero-suppressed, assembled full event and filtered.
- 6 ▪ Online software trigger and data compression algorithm should be study and provided
7 by physics. But the implementation of the data processing inside online farm is DAQ
8 scope.

9 **12.6 Machine detector interface**

10 Machine-Detector Interface (MDI) represents one of the most challenging topics in which
11 both the accelerator and detector will be covered. The interaction region (IR) has to focus
12 both electron and positron beams to small spot sizes to maximize the machine luminosity.
13 The following R&D will be carried out during the next TDR phase:

- 14 ▪ Interaction region layout re-design/optimization
- 15 ▪ Background models validation with experimental data, e.g. SuperKEKB/Belle II
- 16 ▪ Beampipe design together with SR photon protection, HOM absorber and cooling if
17 needed
- 18 ▪ Installation scheme that involves both LumiCal and final focusing magnets
- 19 ▪ Prototyping R&D on LumiCal, and demonstration of alignment of desired precision
20 with laser and optical devices.

21 **12.7 Physics objects performance**

22 The physics objects performance is determined by the detector geometry and reconstruc-
23 tion algorithms, including tracking, particle flow, and particle identification algorithms.
24 For the TDR phase, the following items should be addressed:

- 25 ▪ Theory/Pheno: The control of theoretical uncertainty
- 26 ▪ Data analysis: Calibration Methods, In-situ Calibration
- 27 ▪ Development and validation of sub-detector digitization algorithms.
- 28 ▪ Advanced reconstruction algorithm and pattern recognition studies.

29 **12.8 Engineering and Detector Integration**

30 **12.9 Physics**

31 **12.9.1 Higgs Physics**

32 For Higgs physics, there are a few improvements and updates which can be done at the
33 next stage. First of all, the analyses of many Higgs decay channels for current studies are

1 extrapolated from CEPC-v1 setup. New analyses based on full simulated samples with
2 the most updated geometry in future are expected. The studies now are classified with
3 different Higgs decay modes. An updated analyses categorizing events according to
4 different final state particles are worthwhile to be explored. In addition, some further
5 optimizations can be implemented for the future analyses, e.g. classifying events with
6 variant S/B ratio instead of simply applying cuts to further improve the sensitivity.
7 Finally, some fundamental systematics can be taken into account for the future study.

8 References

- 9 [1] CEPC project website. <http://cepc.ihep.ac.cn>.
- 10 [2] The CEPC-SPPC Study Group, *CEPC-SPPC Preliminary Conceptual Design*
11 *Report, Volume II - Accelerator*, 2015. IHEP-CEPC-DR-2015-01,
12 IHEP-AC-2015-01.
- 13 [3] The ATLAS Collaboration, G. Aad et al., *Observation of a new particle in the search*
14 *for the Standard Model Higgs boson with the ATLAS detector at the LHC*, *Phys. Lett.*
15 *B* **716** (2012) 1–29, [arXiv:1207.7214](https://arxiv.org/abs/1207.7214) [hep-ex].
- 16 [4] The CMS Collaboration, S. Chatrchyan et al., *Observation of a new boson at a mass*
17 *of 125 GeV with the CMS experiment at the LHC*, *Phys. Lett.* **B716** (2012) 30–61,
18 [arXiv:1207.7235](https://arxiv.org/abs/1207.7235) [hep-ex].