

# Photon Reconstruction Performance at CEPC Baseline Detector

Yuqiao Shen

Changzhou Institute of Technology



中国科学院高能物理研究所  
*Institute of High Energy Physics*  
*Chinese Academy of Sciences*



# Outline

- Motivation
- CEPC Baseline Detector & Software
- Reconstruction Performance on single-photon events
  - Photon Conversion Rate
  - Photon Reconstruction efficiency
  - Photon Energy Resolution
- Reconstruction Performance on Di-photon events
  - $\pi^0$  Reconstruction Efficiency

# Motivation

- The CEPC is a future large scale collider complex. It is a proposed **Higgs/Z factory**.
- Photon reconstruction is essential for the CEPC **physics measurement**.
- Photon reconstruction performance is **a critical benchmark** for the CEPC **detector** design and optimization.

# The Baseline Detector

- The Particle Flow Algorithm oriented detector

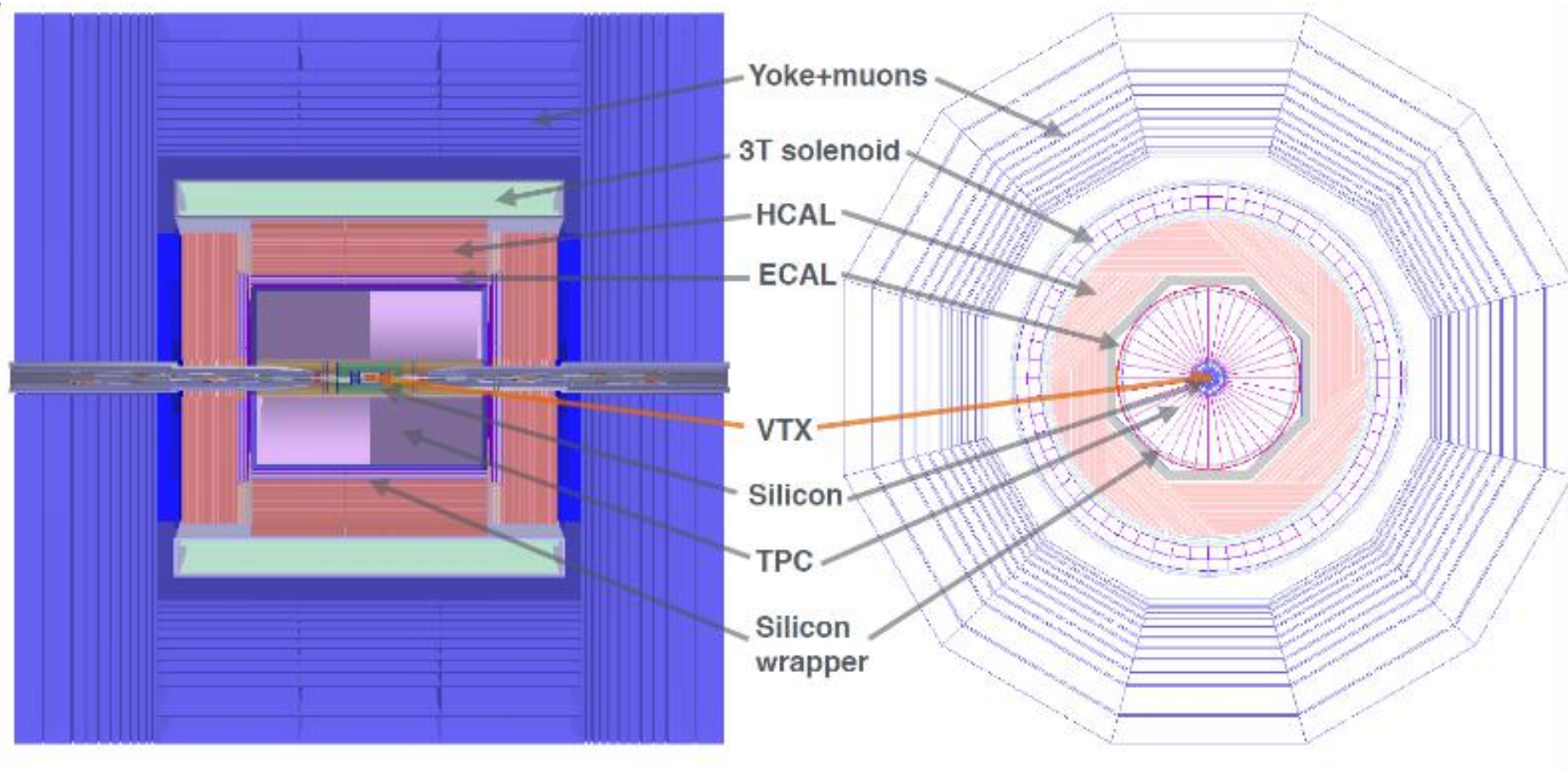

# CEPC Baseline ECAL

- The CEPC uses sampling structure ECAL that is composed of silicon sensors and tungsten absorber plane.
- The **barrel** section is made of 8 staves. Each stave is organized into 5 modules. Each module contains 5 columns. The radius of the barrel section is 2028 mm.
- The two **endcap** sections are composed of 8 quadrants. Each quadrant is made of 2 modules. The two endcap sections are located at  $\pm 2635$  mm.

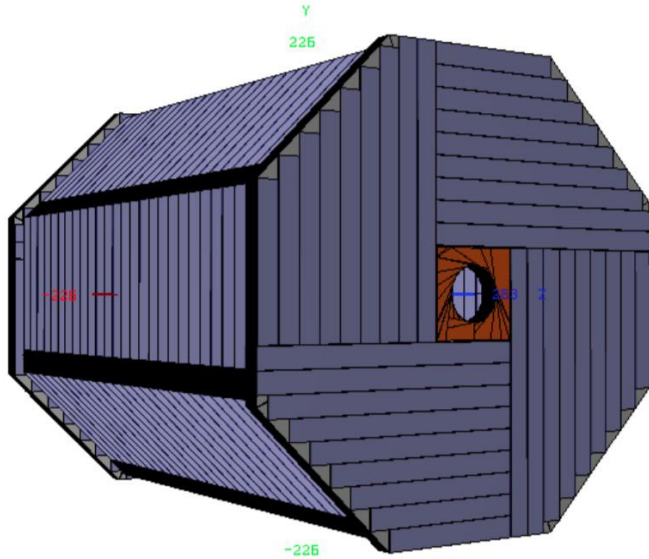

Schematic of the CEPC ECAL layout

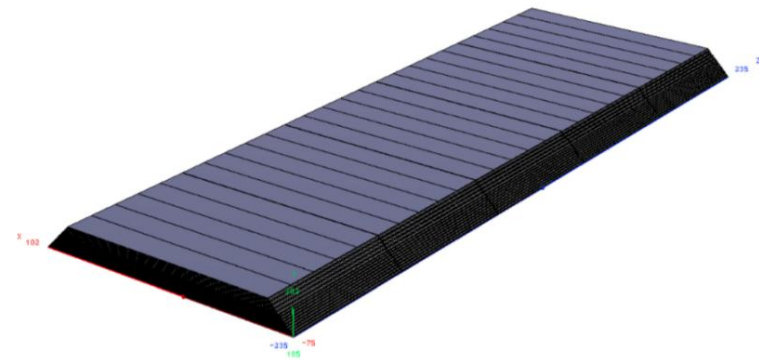

Schematic of the structure of one ECAL stave

# Baseline Software

- Whizard and Pythia are used to generate final state particles for physics processes. MokkaPlus is used for Simulation. Arbor is used to reconstruct physics objects for further analysis.
- A dedicated particle flow reconstruction toolkit, **Arbor**, has been developed.

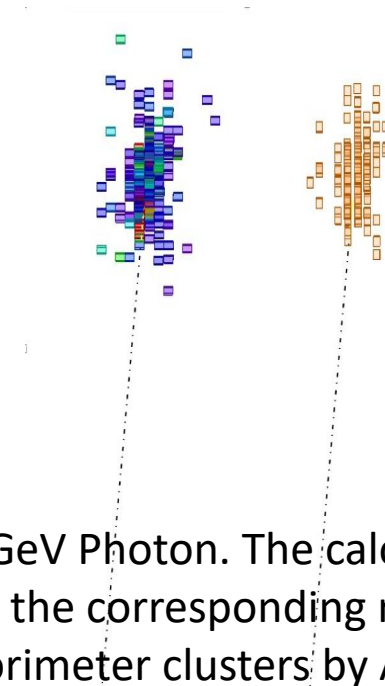
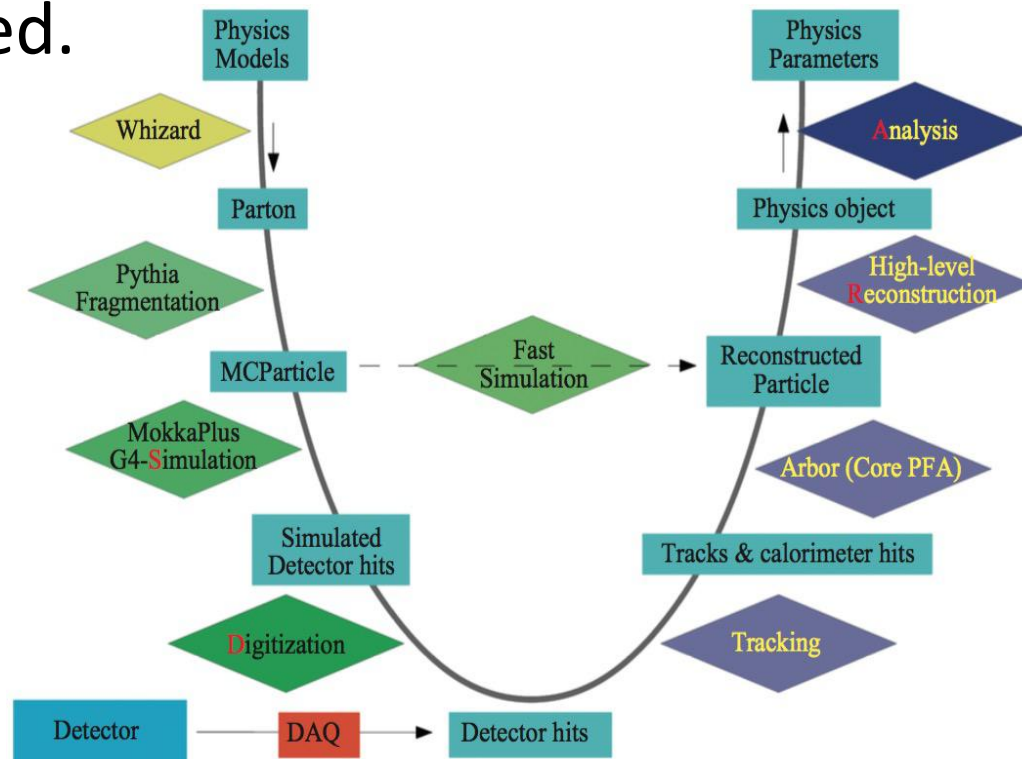

10 GeV Photon. The calorimeter hits and the corresponding reconstructed calorimeter clusters by Arbor.

# Outline

- Motivation
- CEPC Baseline Detector & Software
- Reconstruction Performance on single-photon events
  - Photon Conversion Rate
  - Photon Reconstruction efficiency
  - Photon Energy Resolution
- Reconstruction Performance on Di-photon events
  - $\pi^0$  Reconstruction Efficiency

# Conversion Rate

- Photons may convert to  $e^+e^-$  pairs when they interact with the materials in front of ECAL.

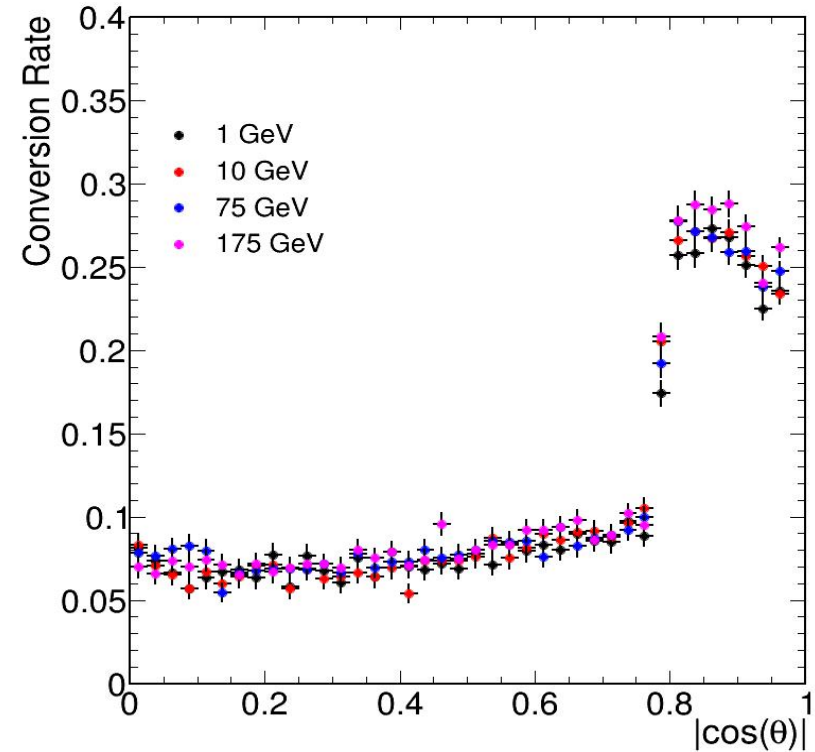
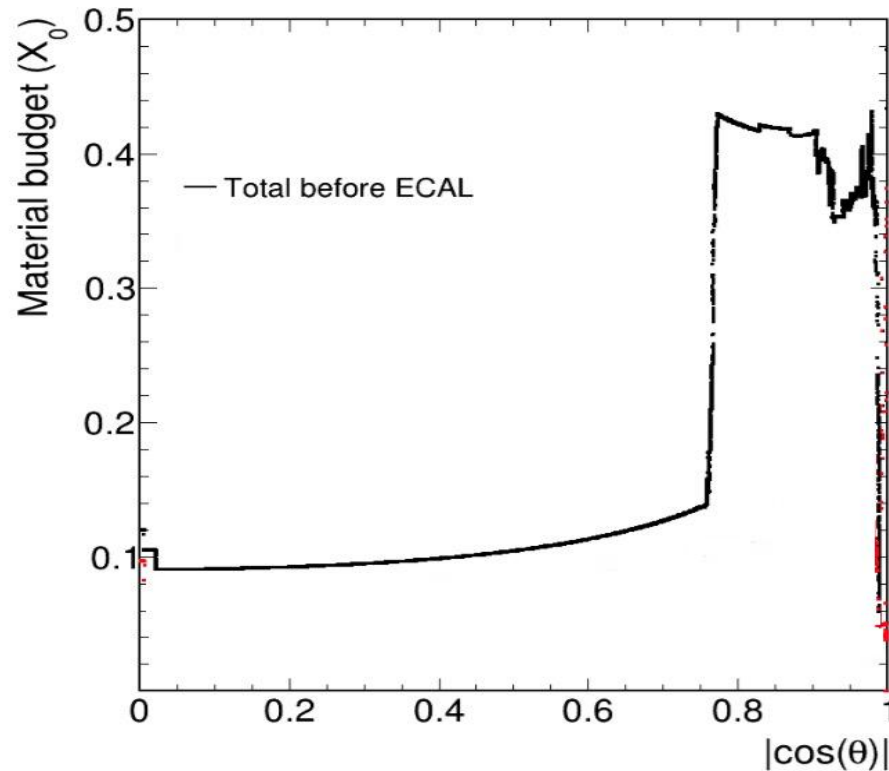

The Photon conversion rate is **proportional** to the material budget.

**5-10%** of photons in the central region and **~25%** of photons in the forward region will convert to  $e^+e^-$



# Reconstruction Efficiency

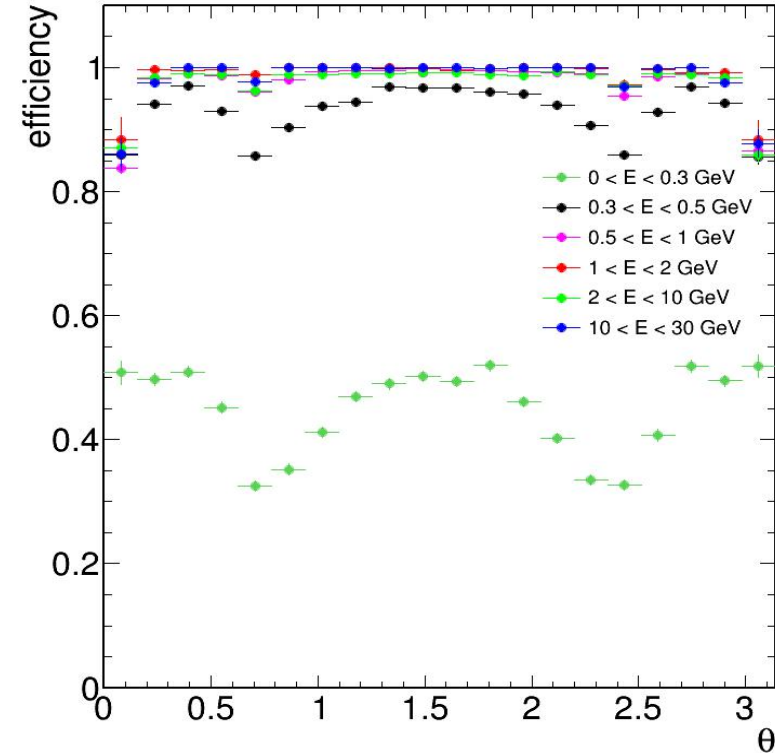
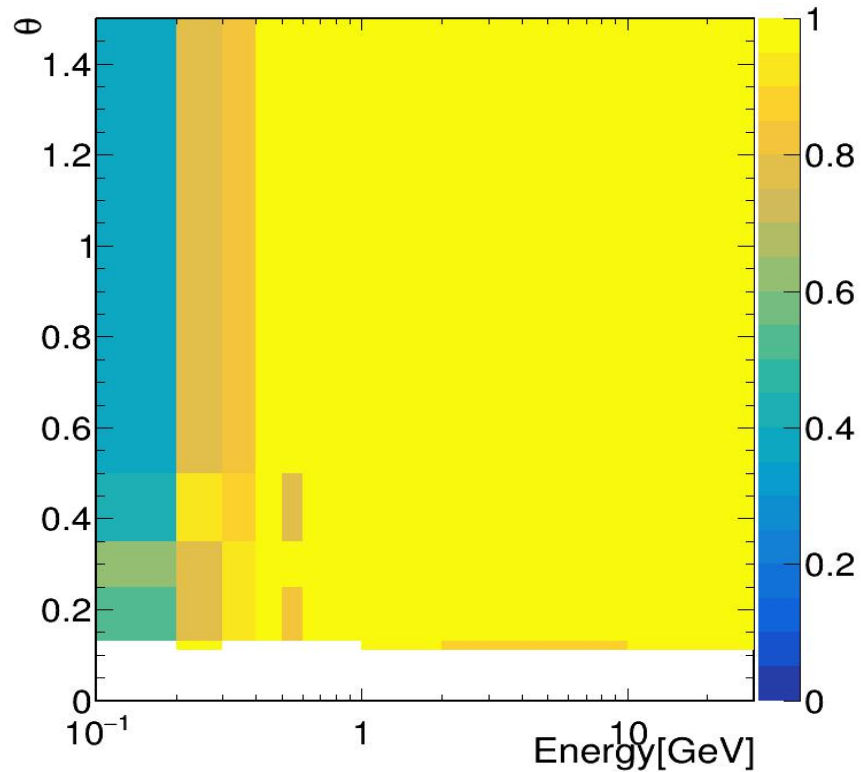

- Between 200 MeV and 500 MeV, efficiencies are varying from 70% to 99% and they are reaching 99% when  $E > 500$  MeV.
- The photon reconstruction efficiency is sensitive to the dead zone between the ECAL barrel and endcaps.

# Photon Energy Resolution

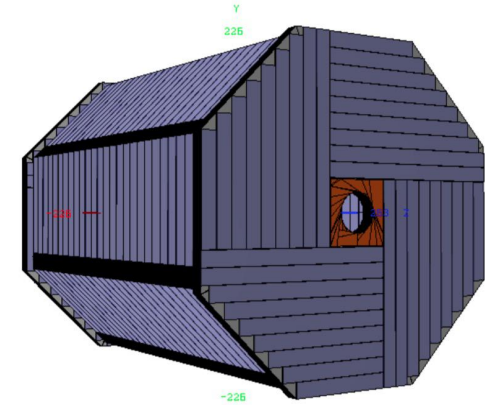
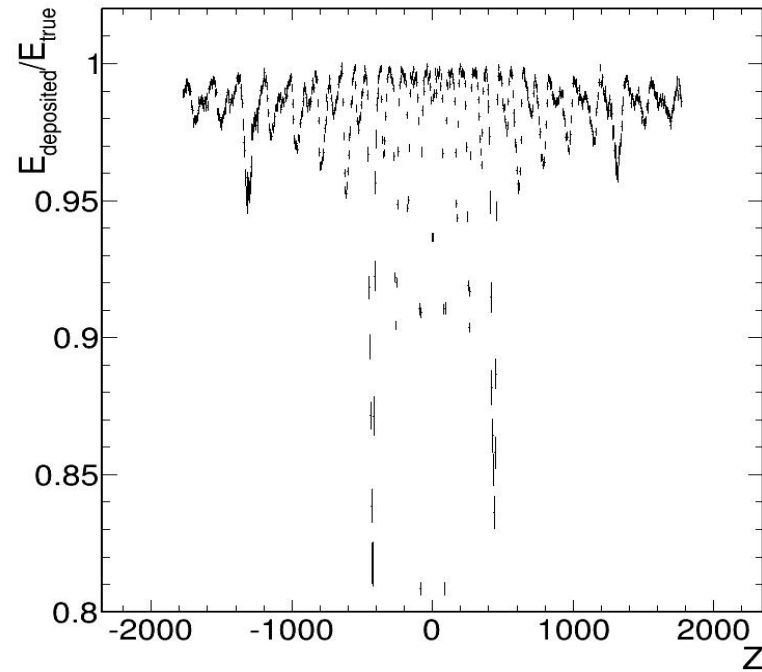
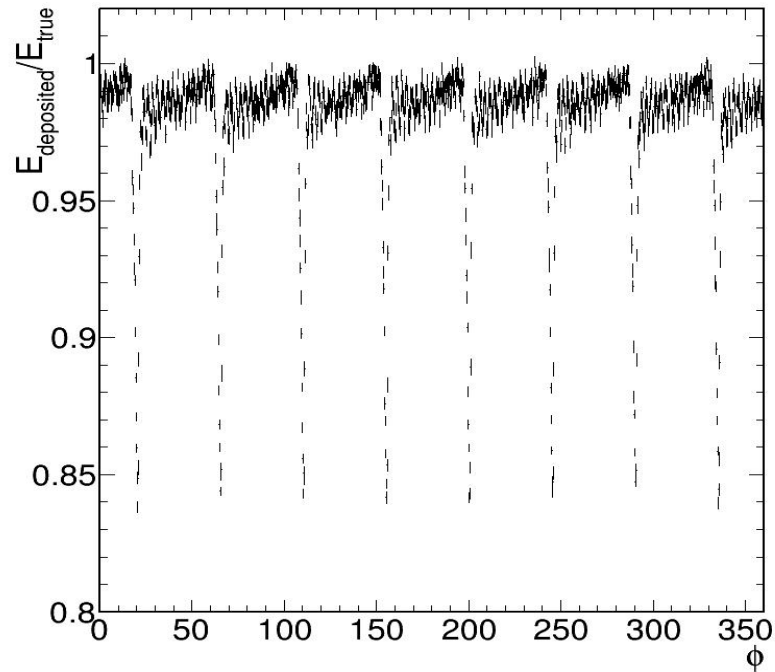

The  $E_{\text{deposited}}/E_{\text{true}}$  distributions as a function of  $\Phi$  and  $Z$  with 50 GeV photons in the central region. They reflect the detailed geometry structure of the baseline detector.

The geometry-based correction algorithm has been developed to scale the EM clusters located at the geometry cracks. The corrected energy is:

$$E_{\text{corrected}} = \frac{E'_{\text{true}}}{E'_{\text{deposited}}} \times E_{\text{deposited}}$$

# Photon Energy Resolution

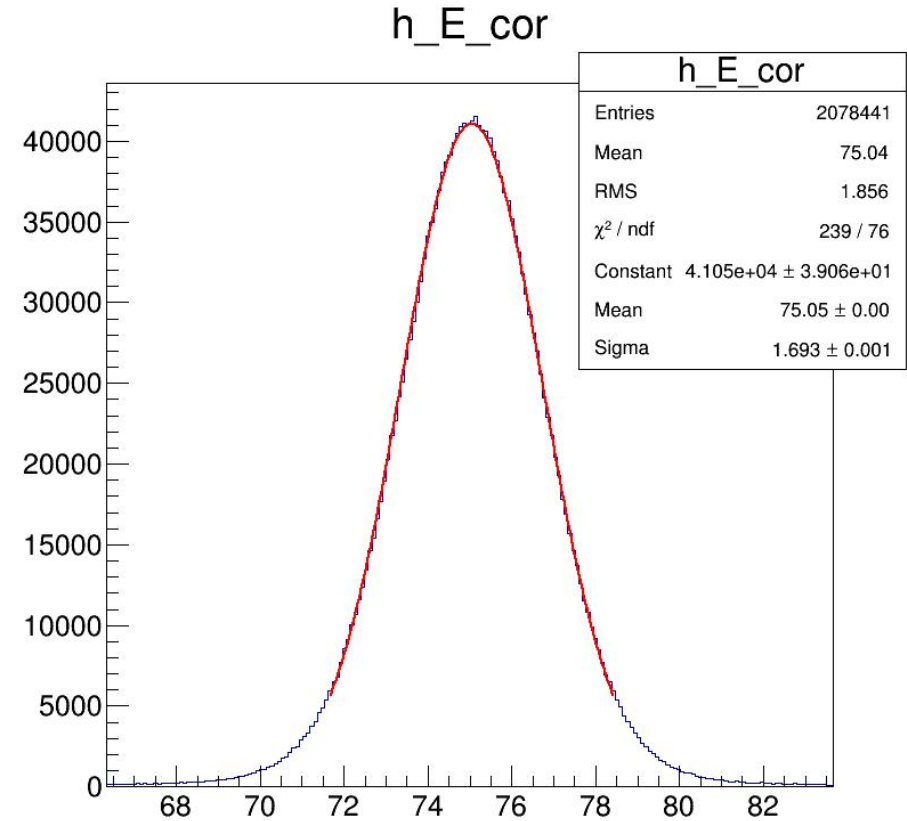
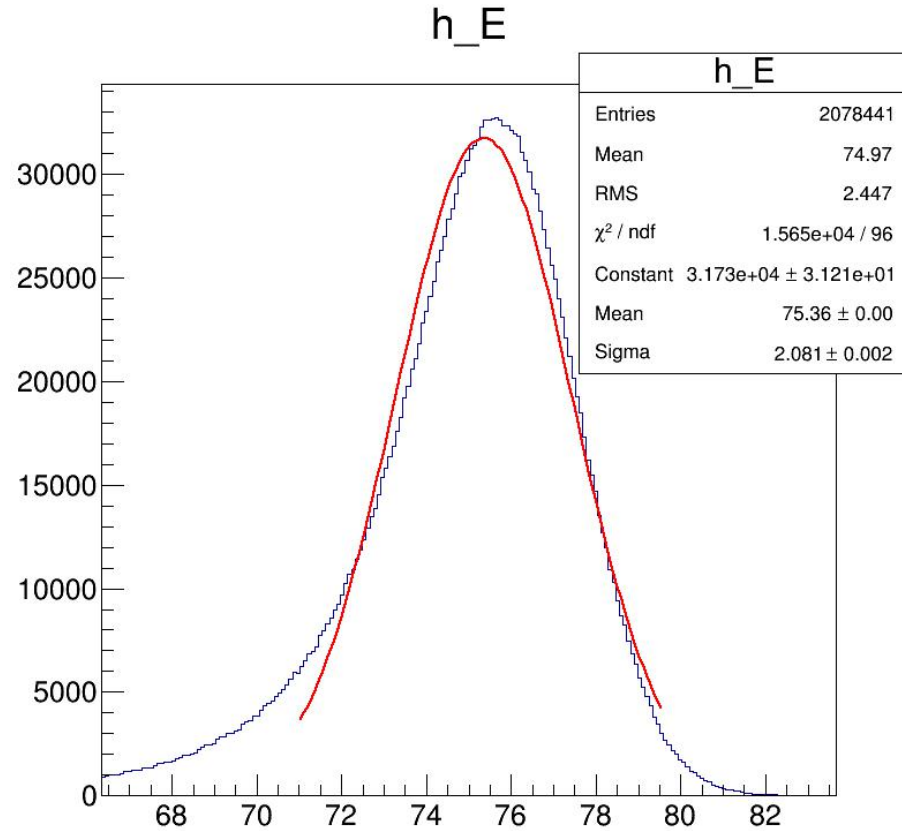

The energy distribution of 75 GeV photon **before (left)** and **after (right)** applying the correction.

# Photon Energy Resolution

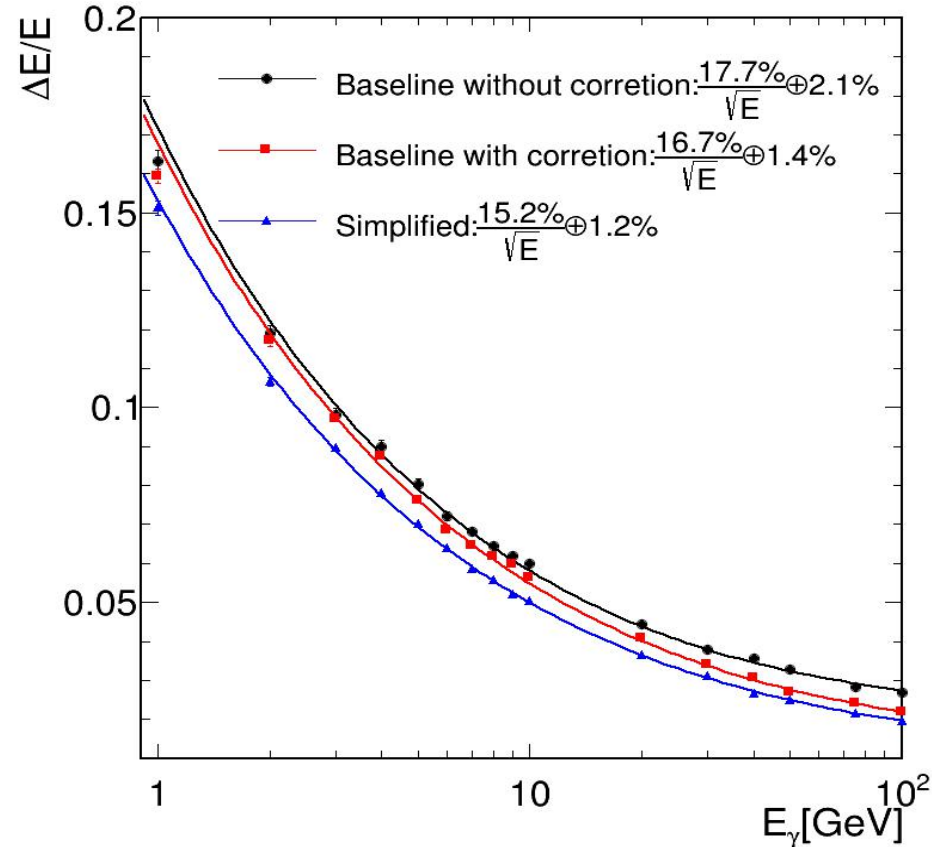

The simplified geometry (ECAL):

no material in front

no gaps between two modules.

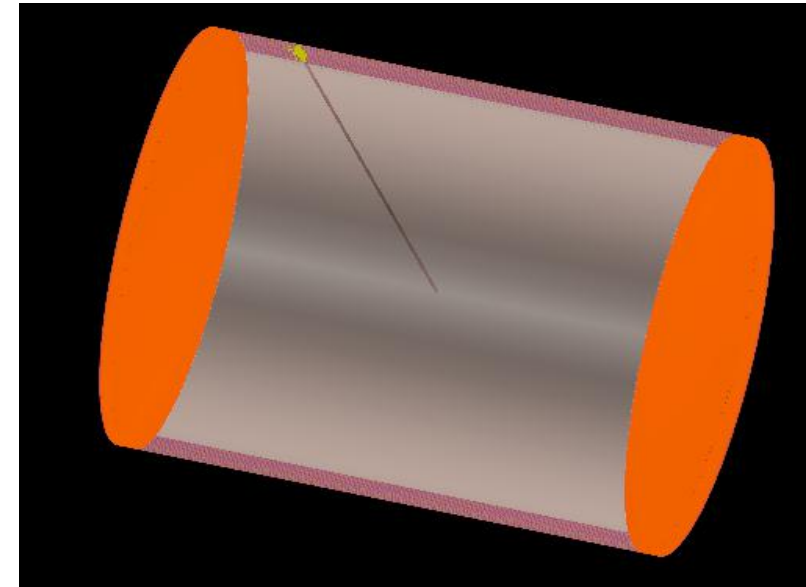

Since the input sample is chosen at 50 GeV, correction at high energy is more significant. The energy-dependent correction algorithm will be developed for later analysis

# Outline

- Motivation
- CEPC Baseline Detector & Software
- Reconstruction Performance on single-photon events
  - Photon Conversion Rate
  - Photon Reconstruction efficiency
  - Photon Energy Resolution
- Reconstruction Performance on Di-photon events
  - $\pi^0$  Reconstruction Efficiency

# Performance on Diphoton events

- The photon reconstruction, especially the separation performance of nearby photon clusters, can be characterized by  $\pi^0$  reconstruction.

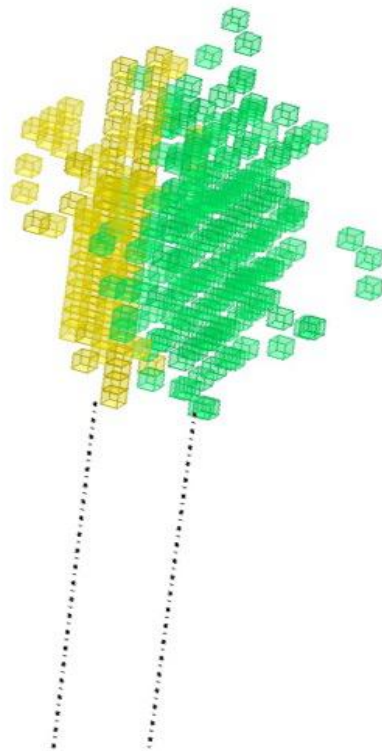

A successfully reconstructed 19 GeV  $\pi^0$ . The calorimeter showers are close to each other but can be separated.

# Performance on Diphoton events

- The chance of the successfully reconstructed  $\pi^0$  is defined as the probability of successfully reconstructed two photons at least and with the leading invariant mass between  $(0.135-5\sigma, 0.135+5\sigma)$  MeV.

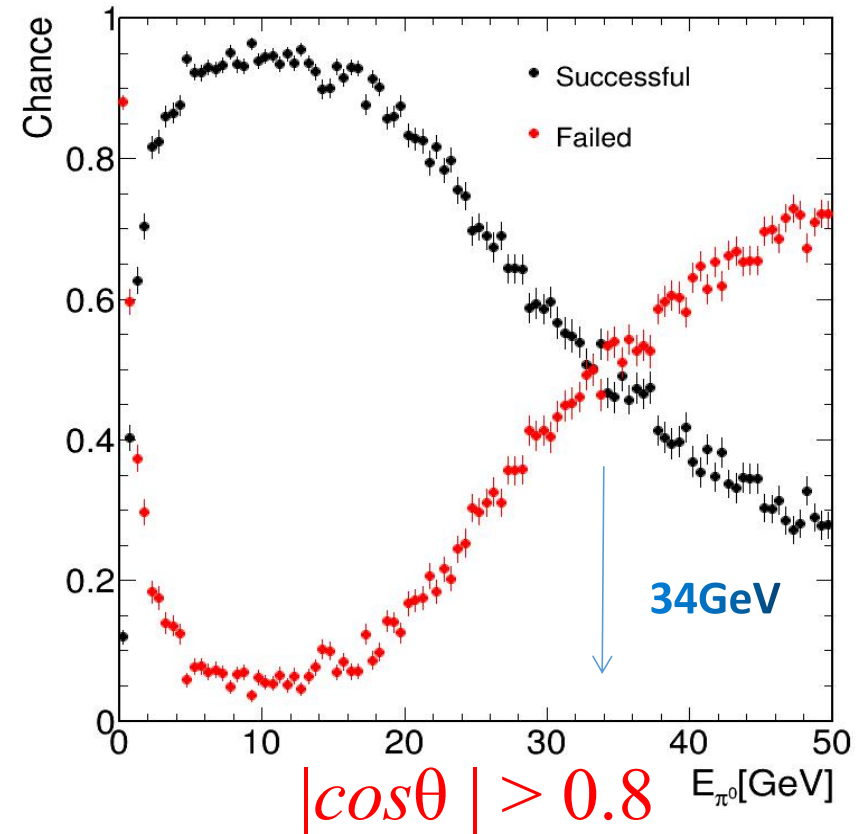
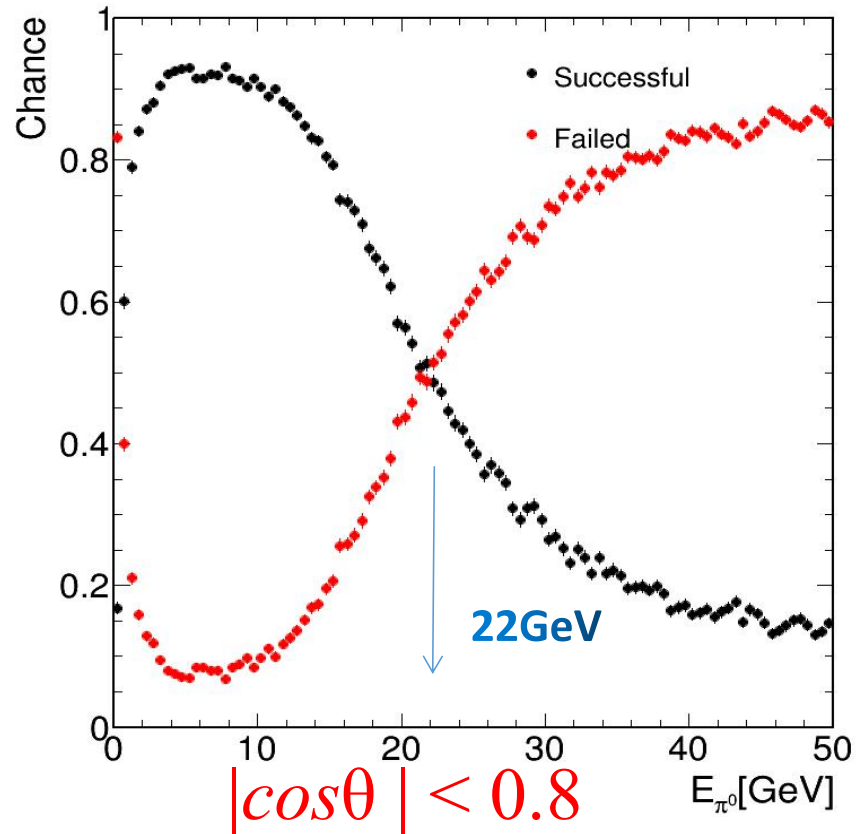

# Performance on Diphoton events

- The generated  $\pi^0$  distributions in different samples.

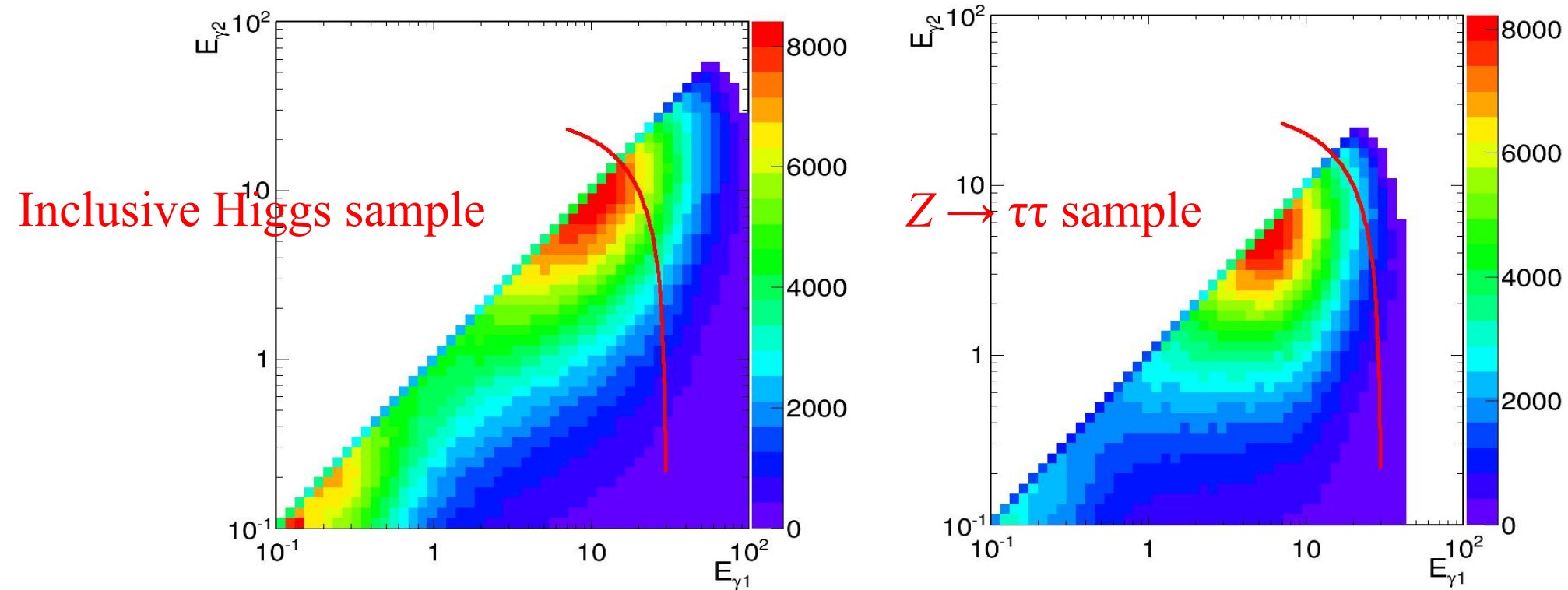

Roughly **15%** of the  $\pi^0$  generated in the inclusive Higgs sample has its energy above the average critical energy (30 GeV).  
Only **3%** of the  $\pi^0$  generated in  $Z \rightarrow \tau\tau$  events exceeds the critical energy threshold.



# Conclusion and Next Setp

- The **conversion rate** is consistent with the tracker materials.
- A high **efficient reconstruction performance** is observed at single photon sample.
- We also investigate the impact of geometry defects on **photon energy resolution** and the possible corrections according to the reconstructed photon position. **An iterative correction algorithm shall be developed in the future.**
- For  $\pi^0$  reconstruction efficiency, the critical energy of 22/34 GeV at the barrel/endcap region is observed using a general PFA reconstruction algorithm (Arbor). **This  $\pi^0$  reconstruction efficiency and the separation performance could be enhanced by applying a dedicated  $\pi^0$  finding and identification algorithm.**



# Conclusion and Next Setp

- The **conversion rate** is consistent with the tracker materials.
- A high efficient reconstruction performance is observed at single photon sample.
- We also investigate the impact of geometry defects on photon energy resolution and the possible corrections according to the reconstructed photon position. The discuss low energy tail induced by the geometry defects can be efficiently eliminated by the correction algorithm. Since the correction algorithm is sensitive to the photon energy, an iterative correction algorithm shall be developed in the future.
- We analyze the  $\pi^0$  reconstruction efficiency as a function of the  $\pi^0$  energy, the critical energy of 22/34 GeV at the barrel/endcap region (corresponding to 50% of the successful reconstruction rate) is observed using a general PFA reconstruction algorithm (Arbor). This  $\pi^0$  reconstruction efficiency and the separation performance could be enhanced by applying a dedicated  $\pi^0$  finding and identification algorithm.

# Geometry defects & correction

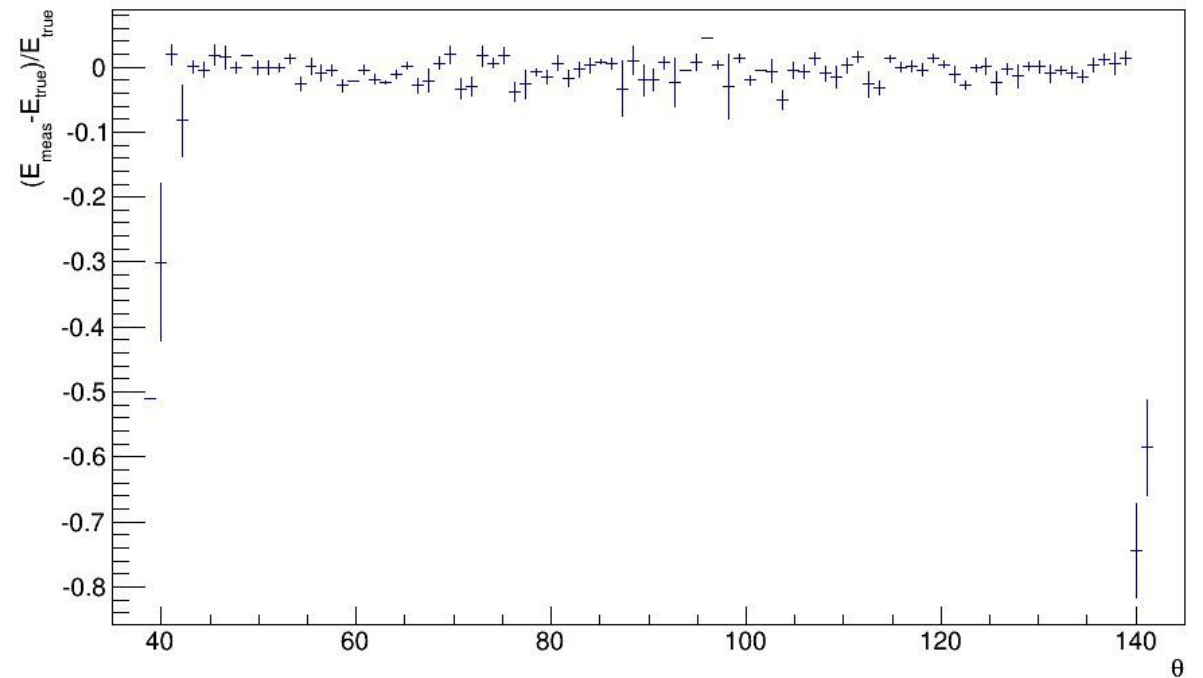
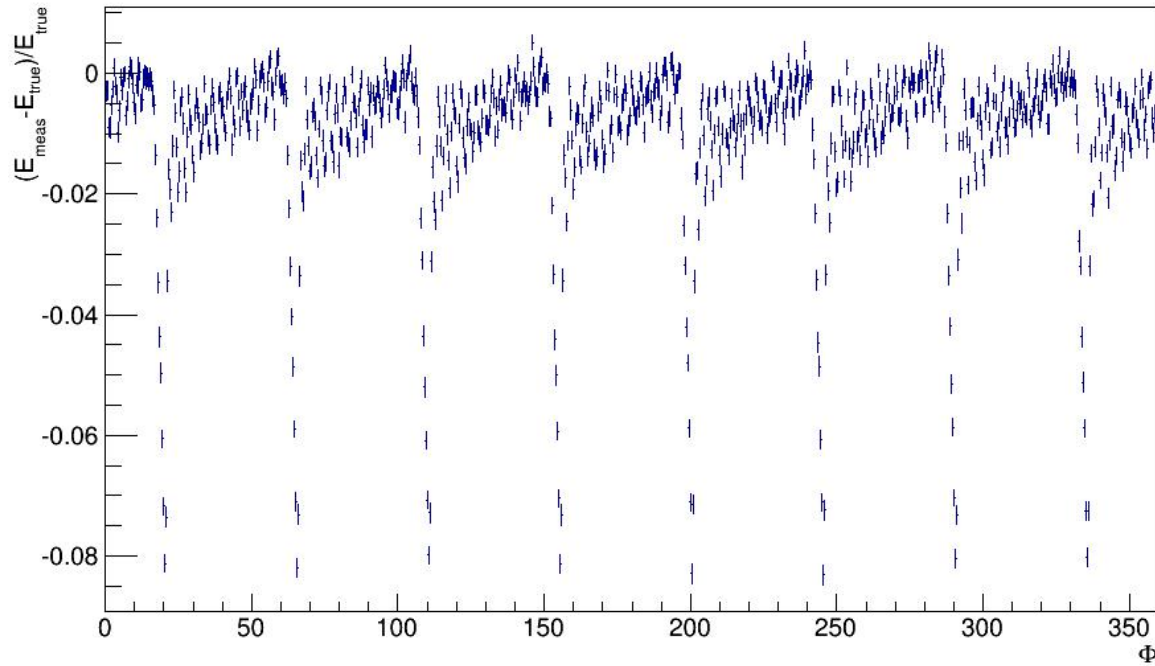

Energy deposited in ECAL depends on the  $\phi$  and  $\theta$ .

Need corrections ( $\phi$ ,  $\theta$ ,  $E_{\text{true}}$ ).

**Only Considering the unconverted Photon in the Barrel case at the hit level**

2019-11-18

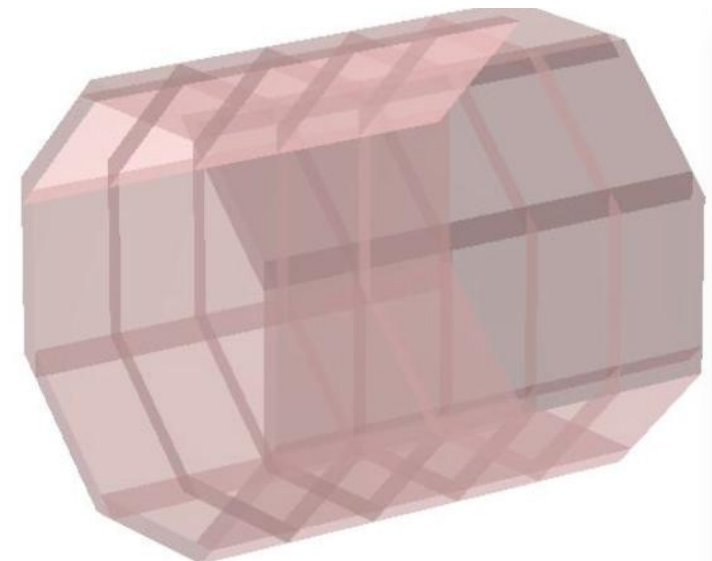

# Motivation

Photons can be produced from ISR, FSR and decays of unstable particles.

Precise photon measurements are essential:

- jet energy resolution
- measurements of  $H \rightarrow \gamma \gamma$
- studies of radiative process
- the  $\tau$  identification
- They impact all aspects of the physics at the CEPC

# Baseline Software

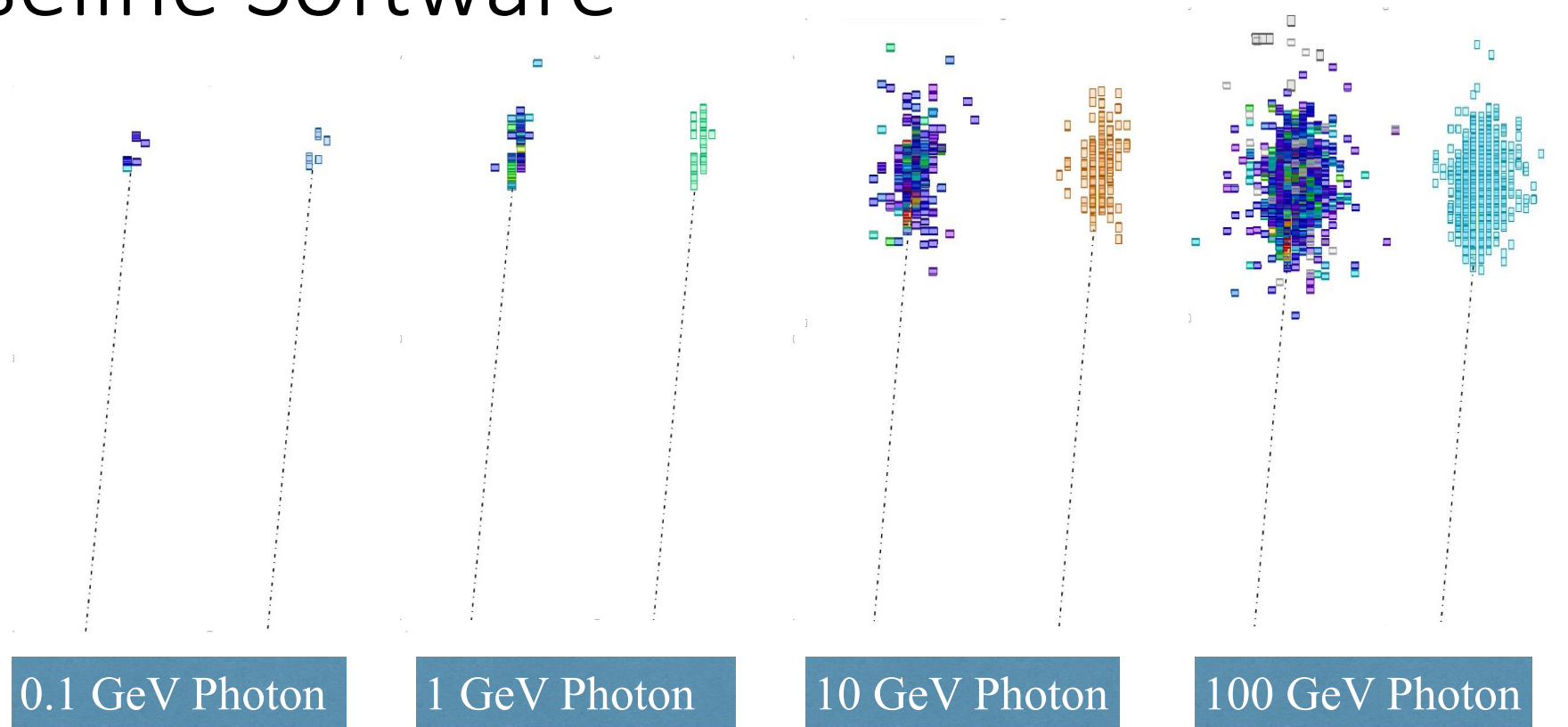

The calorimeter hits and the corresponding reconstructed calorimeter clusters of photons.

